

22
23



OFFROAD

ÉQUIPE COMMERCIALE



Éric LACOUR - Responsable commercial

06 09 15 13 01 - eric.lacour@moraco.fr

Alexandre BRUNEL

06 24 94 39 72 - alexandre.brunel@moraco.fr

Dép. 08, 10, 51, 52, 54, 55, 57, 67, 68, 70, 88, 90

Florian RENAUDIE

06 02 00 49 91 - florian.renaudie@moraco.fr

Dép. 16, 17, 24, 33, 79, 85, 86

Sébastien CALONNE

06 24 94 39 49 - sebastien.calonne@moraco.fr

Dép. 09, 11, 31, 32, 40, 46, 47, 64, 65, 66, 81, 82, Andorre

Gérald VALCESCHINI

06 24 94 39 76 - gerald.valceschini@moraco.fr

Dép. 01, 21, 25, 26, 38, 39, 58, 71, 73, 74, 89

Ludovic DECORDE

06 80 27 96 87 - ludovic.decorde@moraco.fr

Dép. 14, 22, 27, 28, 29, 35, 37, 41, 44, 49, 50, 53, 56, 61, 72, 76

Pierre-Marie FAURE

06 24 94 40 02 - pierremarie.faure@moraco.fr

Dép. 03, 07, 12, 15, 18, 19, 20, 23, 36, 42, 43, 45, 48, 63, 69, 87

Richard MARIONI

06 24 94 40 00 - richard.marioni@moraco.fr

Dép. 04, 05, 06, 13, 30, 34, 83, 84, 98

Christopher MARQUET

07 78 68 52 27 - christopher.marquet@moraco.fr

Paris VIII, IX, XV, XVI, XVII, dép. 78, 92, 93, 95

Vincent OBERT

07 79 82 53 64 - vincent.obert@moraco.fr

Dép. 02, 59, 60, 62, 80

Karen JUDITH

07 86 40 78 08 - karen.judith@moraco.fr

Paris I, II, III, IV, V, VI, VII, X, XI, XII, XIII, XIV, XVIII, XIX, XX, dép. 77, 91, 94

Pour commander

 www.moraco.fr

 commande@moraco.fr

 03 85 51 45 45

 03 85 30 64 61

 **Matin 9h - 12h30**

Après-midi 13h30 - 18h

Le vendredi jusqu'à 16h

 **Livraison J+1**
(jusqu'à 70 kg, hors acide à batterie)

si vous **commandez** :

- avant 14h30 par téléphone,
- avant 15h par email ou fax,
- **avant 16h sur moraco.fr**

*Livraison J+2 à J+4 au-delà de 70 kg,
selon le secteur géographique.*

Conditions

Franco de port

Tous produits 299€ HT

Hors commandes Web

Commandes Web 159€ HT

Calculé sur le prix net facturé

Kit chaîne D.I.D. 0€

À partir de la qualité 2

Minimum de commande 50€ HT

Sauf si franco D.I.D.

Frais de port

Commandes inférieures au franco :

enveloppe 8€ HT

commande < 159€ HT 11€ HT

commande < 299€ HT 10€ HT

Express samedi 5€ HT

*L'acide de batterie est soumis à un franco de 299€ HT quelque soit le moyen de commande.
En dessous de ce franco, le port est facturé selon le barème du transporteur*

Autres frais

Commande < 50€ HT 3€ HT

Modification de commande après validation BL 1€ HT

Paiement par carte bancaire 1€ HT

Facturation mensuelle < 100€ HT 3€ HT

Conditions spéciales

Corse :

- Franco Web à 299€ HT
- Produits dangereux livrés en J+5

Édito

Cher Client et futur Client,

Ce n'est pas un secret, ici on aime le Tout Terrain.

Alors oui, nous sommes fiers de partager le Nouveau Catalogue UP DESIGN MOTO : la branche 100% Tout-Terrain de MORACO. Il est le fruit d'un travail d'équipe et de passionnés.

Nous avons de belles marques pour Vous et vos clients :

SBS, SUPERSPROX, DID, PROGRIP, RTECH, PROTAPER, PUTOLINE, VEE RUBBER, IPONE, XENA, OPTIMATE et de belles nouveautés, cette année aussi, comme FMF, AFAM, MIW filters, SENA.

C'est dans cet esprit que nous avons créé la gamme UP DESIGN MOTO dont le slogan « Passion for Dirt » est explicite.

Nous avons développé et testé avec les Pilotes nos propres produits avec un design soigné et une qualité premium. La gamme UP DESIGN MOTO s'est élargie : lève-moto, sangles, tapis environnemental, housses de selle, kits déco réalisés avec KutveK, mousses de guidon spécial Enduro et la gamme complète de mousses pneus... sans oublier du sportswear pour les paddocks.

Cédric SOUBEYRAS fait partie de la famille depuis plusieurs saisons et participe au développement de notre marque.

Plusieurs Teams et pilotes en MX, SX, Enduro, Sable et Rallye raid sont nos ambassadeurs UP et roulent avec nos produits.

Suivez-les, suivez l'actualité UP DESIGN sur facebook et instagram.

Et surtout, vivement que la saison démarre pour vous retrouver sur les circuits ou les chemins !

Brrraaaaapppp !!



Jérôme DELZIANI



SPORTSWEAR	16
TECHNIQUE MOTO	22
KIT DÉCO	26

POSTE DE PILOTAGE 29

GUIDE D'APPLICATION LEVIERS	30
GUIDONS PROTAPER	38
MOUSSES DE GUIDON UP DESIGN	46
CROCHET DE DÉPART PROTAPER	49
POIGNÉES PROTAPER	50
POIGNÉES PROGRIP	52
POIGNÉES RTECH	60

ÉQUIPEMENT DU PILOTE 63

SPORTSWEAR UP	64
MASQUES FMF	70
SOLAIRES FMF	84
MASQUES PROGRIP	88
CASQUES PROGRIP	106
INTERCOMS SENA	110

ÉQUIPEMENT DE LA MOTO 125

KIT DÉCO UP DESIGN MOTO	126
HOUSSE DE SELLE UP DESIGN MOTO	180
NUMÉROS UP DESIGN MOTO	181
PLASTIQUES RTECH HONDA	182
PLASTIQUES RTECH YAMAHA	188
PLASTIQUES RTECH KAWASAKI	196
PLASTIQUES RTECH SUZUKI	200
PLASTIQUES RTECH KTM	204
PLASTIQUES RTECH HUSABERG	212
PLASTIQUES RTECH HUSQVARNA	214
PLASTIQUES RTECH GAS GAS	220
PLASTIQUES RTECH BETA	222
PLASTIQUES RTECH UNIVERSELS	224
PROTÈGE MAINS RTECH	230
PROTECTIONS RTECH	246

TRANSMISSION 255

GUIDE D'APPLICATION KIT CHAÎNE	256
SUPERSPROX	278
D.I.D	284
AFAM	290

FREINAGE 315

GUIDE D'APPLICATION	316
SBS	372
BRAKING	373

FILTRATION 375

GUIDE D'APPLICATION	376
DT1	406
MIW	410

PNEUMATIQUES 415

CROSS	416
ENDURO	417
TRAIL / TRIAL / MINI PITBIKE	418
MOUSSES	420
CHAMBRES À AIR	422

LUBRIFIANTS 425

PUTOLINE	426
IPONE	442
WD40	450
KYB	453
GS27	454

ÉLECTRICITÉ 459

GUIDE D'APPLICATION	460
BATTERIES	514
CHARGEURS ENERGYSAFE	528
CHARGEURS LITHIUM SKYRICH	530
CHARGEURS OPTIMATE	532
CONNECTIQUE OPTIMATE	543
BOUGIES NGK	546
AMPOULES PHILIPS / RTECH / HERT	550

PIÈCES TECHNIQUES 557

GUIDE D'APPLICATION CHÂSSIS	558
GUIDE D'APPLICATION MOTEUR	596
GUIDE D'APPLICATION SUSPENSIONS	602
GUIDE D'APPLICATION ROUES	638
GUIDE D'APPLICATION ROULEMENTS COLONNE DE DIRECTION	652

ATELIER 659

XENA	660
TOPLINE	670
SPM	672
MOTORSCAN	676
ACCESSOIRES D'ATELIER	680

SOMMAIRE

LES TEAMS & PILOTES



DAFY ENDURO TEAM





TEAM ATOMIC MOTO



LES TEAMS & PILOTES

R'ONE TEAM

Erwan CHARVET



TEAM JS

Xavier DE SOULTRAIT

Dakar 2022



Crédit photo: Félix D'ALIGNY



Benjamin MELOT

Dakar 2022



Crédit photo: @rallyzone



LES TEAMS & PILOTES



SX TOUR





Cédric SOUBEYRAS et UP DESIGN, une relation solide !

Après 3 années aux côtés de SOUB à travers le Team 2B UP by MORACO, nous sommes heureux de vous annoncer que ce partenariat de confiance est prolongé en 2022 !

Chaque mois, vous pourrez retrouver le « produit du mois » UP DESIGN MOTO sur les réseaux sociaux de SOUB pour vous permettre de profiter des meilleures offres sur les produits UP DESIGN MOTO qu'il utilise !

« C'est avec plaisir que je vous annonce mon premier partenaire : UPDESIGN MOTO, pour cette nouvelle aventure ! »

Cédric SOUBEYRAS



MÉDIAS & RÉSEAUX

PROGRIP

COMBIEN DE ROLL-OFF PROGRIP SUR LA PREMIÈRE LIGNE AU TOUQUET ?

ROLL OFF PROGRIP
La référence, assurément.

NOUVEAUTÉ RIOT ROLL-OFF
139,90€ TTC conseillé

ATZAKI ROLL-OFF
149,90€ TTC conseillé

MORACO

www.moraco.fr

ON VEND TOUT SAUF DE L'HUILE DE COUDE !

DESIGN UP MORACO

PROTECTOR 31
 RIDE TIGHT
 SHOCK PINS
 SHOCK BOLTS
 EXTENSION
 RIDE TIGHT
 SHOCK PINS
 SHOCK BOLTS
 EXTENSION

RIDE TIGHT
 SHOCK PINS
 SHOCK BOLTS
 EXTENSION

MORACO

www.moraco.fr

FNF VISION
BEYOND POWER

ZACH OSBORNE
2020 450 MOTOCROSS CHAMP

**POWERBOMB
ROCKET WHITE**

**POWERBOMB
HIS OF A**

**POWERBOMB
CRACK**

**POWERBOMB
ROCKET BLUE**

**TRÉPIED
10 COLORIS**

**BIDON
CAPACITÉ DE 15L
5 COLORIS**

TECH

MORACO

www.moraco.fr

GARDEZ LE CONTACT !

NOUVELLE MOUSSE SPÉCIALE ENDURO - GRIP - MOTRICITÉ

NOUVEAU

Full Contact

MOUSSE COMPATIBLE TOUS PNEUS ENDURO

À PARTIR DE **99€90** **MADE IN EUROPE**

Fabriquée en Italie. Tailles disponibles : 90/90-21, 80/100-21, 140/80-18.

SCANNEZ-MOI ET RETROUVEZ CE PRODUIT DIRECTEMENT EN LIGNE

DISTRIBUTEUR EXCLUSIF **UP DESIGN MORACO**

RACING OFFROAD

sbs GROUP

Freinez fort, virez vite, recommencez !

- Nouvelle gamme de disques de frein
- Gamme complète de plaquettes
- Fabriquées au Danemark

MORACO www.moraco.fr

DISTRIBUTEUR EXCLUSIF **UP DESIGN MORACO**

Vee Rubber

VRM 211
Enduro homologué **FIM**
à partir de **62.00 €**
Prix TTC publics conseillés

VRM 500 AGGRESSIVE
Cross homologué
à partir de **46.00 €**
Prix TTC publics conseillés

UP MOUSSES à partir de **79.90 €**

UP DESIGN MORACO
DISTRIBUTEUR EXCLUSIF

PASSION FOR DIRT DESIGN

Marché en ligne **WWW.UPDESIGNMOTO.COM**

SPORTSWEAR TECHNIQUE PROTECTION MOTO STICKERS ET DECO

UP DESIGN MORACO

Rejoignez-nous !





La marque...

qui monte ! Vous êtes de plus en plus nombreux à faire confiance à la marque UP DESIGN MOTO. Et pour cause, la qualité est au rendez-vous et les prix sont attractifs.

Dans cette catégorie, retrouvez les nouvelles mousses de guidon.





SPORTSWEAR	16
TECHNIQUE MOTO	22
KIT DÉCO	26



SPORTSWEAR



Sweat capuche

Original, épais et chaud !



Sweat à capuche

- S **88HBS**
- M **88HBM**
- L **88HBL**
- XL **88HBXL**
- XXL **88HBXXL**

48,90 €
11.6

Logo en feutrine brodé
Fermeture éclair renforcée
Coupe fluide
60% Coton, 33% Polyester



T-shirts et polo

Bien coupés et robustes.



Manches longues

M **88TSMBLM**
 L **88TSMBLL**
 XL **88TSMBLXL**
 XXL **88TSMBLXXL**

30,90 € t.t.c.

Logo imprimé
 Col rond
 Coupe fluide
 100% Coton

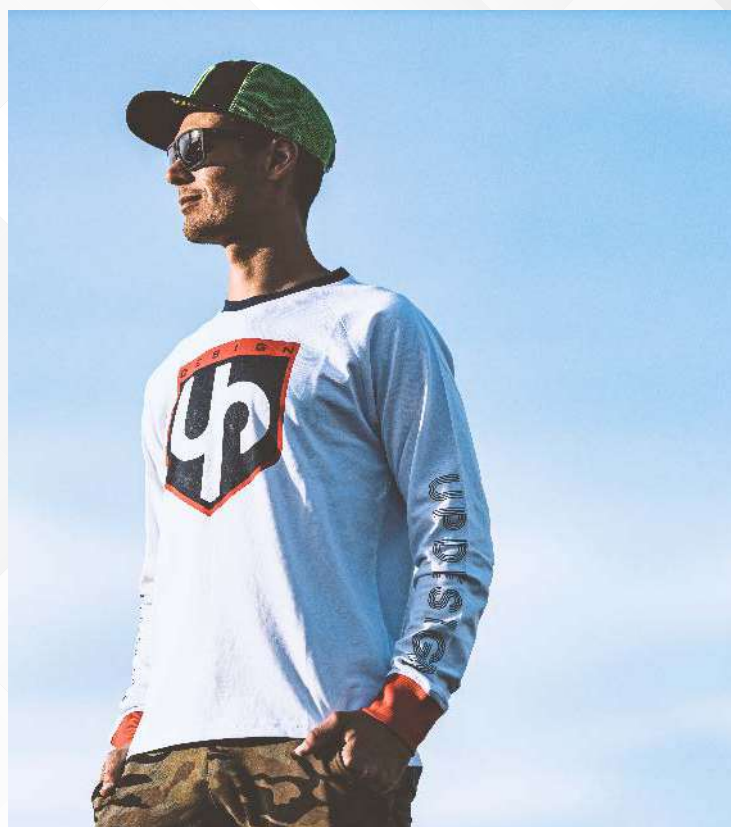

Manches courtes

S **88TSMCBLS**
 M **88TSMCBLM**
 L **88TSMCBLL**
 XL **88TSMCBLXL**
 XXL **88TSMCBLXXL**
 Femme M **88TSFMCBLM**
 Enfant 8/10 **88TSEMCL08**

21,90 € t.t.c.

Logo imprimé
 Col rond
 Coupe fluide
 100% Coton



Polo

S **882001**
 M **882002**
 L **882003**
 XL **882004**
 XXL **882005**

32,90 € t.t.c.

Logo imprimé poitrine
 Col trois boutons
 Coupe fluide
 100% Coton

Maillot

M 885001
L 885002
XL 885003
XXL 885004

26,90 €
I.T.E.

Logo imprimé
Col rond
Coupe fluide
100% Polyester



Veste sans manche



M 883001
L 883002
XL 883003
XXL 883004

54,90 €
I.T.E.

Logo brodé
Col haut
Coupe fluide
Fermeture éclair
50% Coton, 50% Polyester

Doudoune



M 884001
L 884002
XL 884003
XXL 884004

76,90 €
I.T.E.

Logo brodé
Col haut
Coupe fluide
100% polyester,
rembourrage synthétique

Couvre-chefs

Casquette et bonnets



Bonnet

881001

Logo imprimé et brodé
 Doublé polaire
 Taille unique
 100% Polyester

16,90 € T.T.C.



Casquette

21,90 € T.T.C.

881002

Filet au dos
 Réglage pression
 Visière : 7 cm
 Hauteur de tête : 10.5 cm
 60% coton 40% polyester



NOUVEAUTÉ

 **Bluetooth®**

Bonnet Bluetooth®

24,90 € T.T.C.

88BONNET

Logo imprimé et brodé
 Doublé polaire
 Taille unique
 100% Polyester
 Écouteurs intégrés
 Éco taxe 0,02€

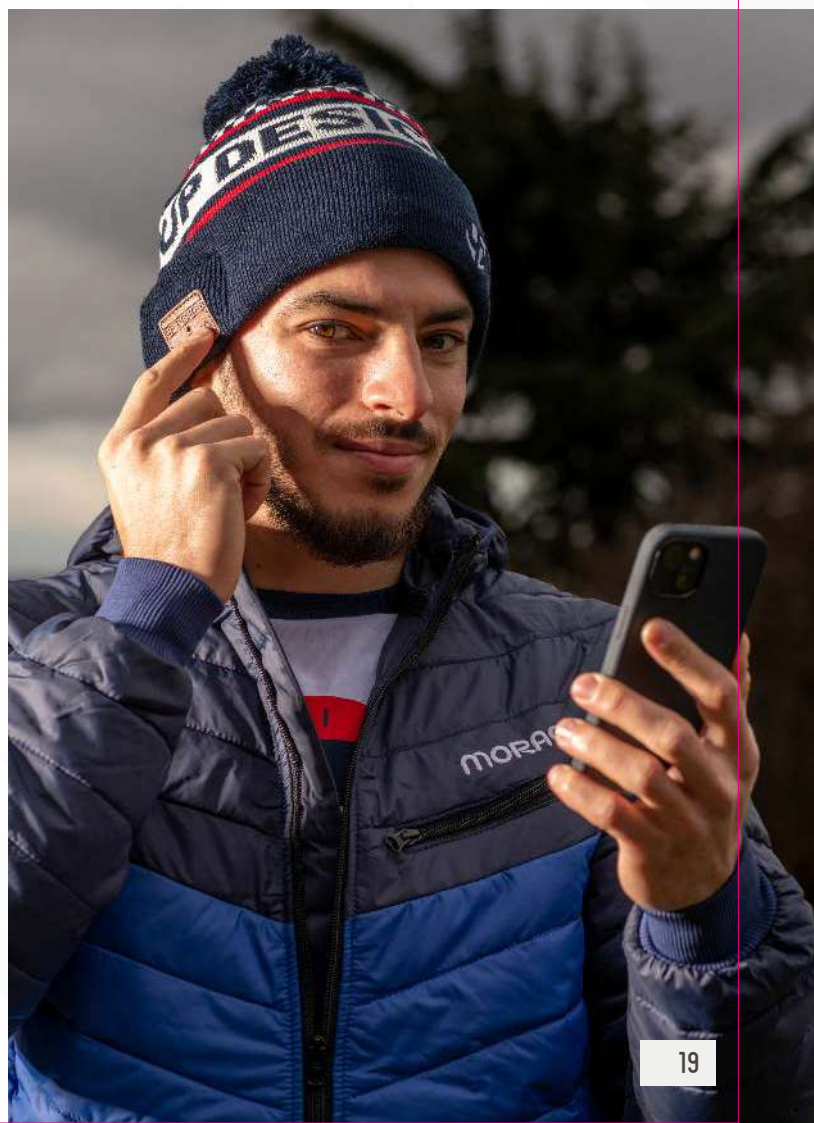

Gilet Bodywarmer 86,90 € T.T.C.

NOUVEAUTÉ

Le gilet Bodywarmer vous apportera le style et le confort avec un tissu imperméable et des zips étanches. Vous pourrez le porter en appoint dessous comme sur une autre veste. La petite poche arrière n'est pas faite pour mettre votre gibier, mais vous pourrez y mettre un bonnet, tour de cou Up DESIGN ou votre masque FMF.

100% polyester • enduction • doublure mesh • zips étanches

S	883100
M	883101
L	883102
XL	883103



Veste Corporate Paddock 97,90 € T.T.C.

S	886000
M	886001
L	886002
XL	886003

NOUVEAUTÉ

Cette veste a été conçue pour être légère et imperméable.

Le tissu est enduit et les zips sont étanches afin de mieux résister aux intempéries.

Nous avons soigné les détails afin de la rendre confortable avec une protection du menton en haut du zip, une petite visière sur la capuche, une poche au niveau de l'avant bras et un serrage en bas de la veste et sur la capuche. Sans oublier le serrage au niveau des poignets et la poche intérieure.

Tellement confortable et légère que vous oublierez même l'avoir sur vous !

100% polyester • enduction • doublure mesh • zips étanches

Tour de cou

16,90 €
I.T.C.

NOUVEAUTÉ



88TDC01
Respirant
Séchage rapide
100% Polyester



Porte clé

5,40 €
I.T.C.

88CLE
Caoutchouc souple
Anneau et chaînette



PRODUITS TECHNIQUES



Mousse de guidon
chrono intégré

32,90 €
T.T.C.

NOUVEAUTÉ

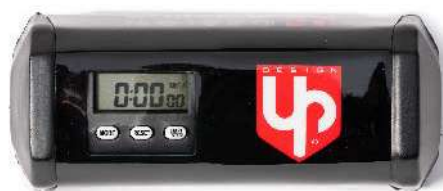

Chronomètre, minuteur, alarme et horloge !

Chrono intégré - 88MOUSSCHRON



Mousse de guidon horloge intégrée

26,90 €
T.T.C.

NOUVEAUTÉ



Rouge - 88MOUSSHORLR



Bleue - 88MOUSSHORLB



Noir - 88MOUSSHORLN



Orange - 88MOUSSHORLO



Orange - 88MOUSSHORLBC 29,90 €
T.T.C.

Cylindrique

Horloge intégrée

32,90 €
T.T.C.

NOUVEAUTÉ

Noire - 88MOUSSHORLCN





Mousse pour pneu haute qualité.

Longévité accrue. Gel pour installation inclus

Dimensions	Référence	€ T.T.C.
100/90-19 MX	MUP10919	99,90€
110/90-19 MX	MUP11919	99,90€
70/100-19 MX NEW	MUP70119	99,90€
80/100-21 MX NEW	MUP80121	89,90€
90/100-16 MX NEW	MUP90116	102,20€
120/90-18 Enduro	MUP12918	93,40€
120/90-18 Enduro soft NEW	MUP12918S	104,40€
140/80-18 Enduro	MUP14818	99,90€
140/80-18 Enduro soft NEW	MUP14818S	109,90€
90/90-21 et 80/100-21	MUP8121	87,90€
90/90-21 Enduro soft NEW	MUP9921S	99,90€
MUPLUB - Gel pour installation	MUPLUB	5,40€



Lève moto

NOUVEAUTÉ
UP MX LIFT- UPMXL 79,90 €
T.T.C.

Indispensable

Ce modèle universel est l'outil indispensable pour toutes vos opérations d'entretien et de maintenance sur votre moto tout terrain.

Caractéristiques

Plateau antidérapant : 165x275 mm

Hauteur position basse : 290 mm

2 niveaux de hauteur : 380 mm et 395 mm



Tapis environnemental

Sangles

Tapis- 88TAPIS
43,90 €
T.T.C.
Rouge - 88SANGLENR
Orange - 88SANGLENO
27,90 €
T.T.C.
 La paire

KIT DÉCO

Retrouvez les deux modèles de kit déco UP DESIGN MOTO by KUTVEK à la page 126

ROUND



design by Kutvek

SPiKe

SERIE



HOUSSE DE SELLE

Complétez votre personnalisation
ou remise à neuf avec nos
housses de selle page 180





La marque...

qui monte ! Vous êtes de plus en plus nombreux à faire confiance à la marque UP DESIGN MOTO. Et pour cause, la qualité est au rendez-vous et les prix sont attractifs.

Dans cette catégorie, retrouvez les nouvelles mousses de guidon.





POSTE DE PILOTAGE

LEVIERS /
SÉLECTEURS /
GUIDONS /
MOUSSE DE GUIDON /
POIGNÉES /



GUIDE D'APPLICATION LEVIERS



30

Guidons PROTAPER	38
Mousses de guidon UP	46
Crochet de départ PROTAPER	49
Poignées PROTAPER	50
Poignées PROGRIP	52
Poignées RTECH	60

Cyl	Modèle	Année	LEVIER GAUCHE EMBRAYAGE OU FREIN	€ T.T.C.	LEVIER DROIT FREIN	€ T.T.C.
APRILIA						
350	Tuareg	89-89			440534	17,56 €
450	MXV450	09-14			440650	9,16 €
450	RXV450	06-14			440650	9,16 €
450	SXV450	06-14			440650	9,16 €
550	RXV550	06-14			440650	9,16 €
550	SXV550	06-14			440650	9,16 €
BETA						
50	RR50 Enduro	12-13	440741	7,70 €		
50	RR50 Enduro Factory	12-16	440741	7,70 €		
50	RR50 Enduro Std	12-15	440741	7,70 €		
125	Alp 125	02-05	440741	7,70 €		
200	Alp 200	00-05	440741	7,70 €		
350	Alp 4.0 350	04-05	440741	7,70 €		
FANTIC						
125	XE 125	21-22	440835	10,60 €	440774	23,20 €
125	XX 125	21-22	440835	10,60 €	440774	23,20 €
250	XEF 250	21-22	440697	10,06 €	440774	23,20 €
250	XX 250	22-22	440835	10,60 €	440774	23,20 €
250	XXF 250	22-22	440775	13,90 €	440774	23,20 €
450	XEF 450	22-22	440697	10,06 €	440774	23,20 €
450	XXF 450	22-22	440775	13,90 €	440774	23,20 €
GAS GAS						
250	MC250	22-22	440657	23,15 €		
350	EC350F	21-22	440657	23,15 €		
350	MC350F	22-22	440657	23,15 €		
HM						
125	CRE125 Enduro	02-03	440561	9,16 €	440560	9,16 €
125	CRE125 Enduro	04-06	440649	9,16 €	440560	9,16 €
230	CRF230 Easy	04-06			440560	9,16 €
250	CRE250 F Enduro	04-06	440649	9,16 €	440650	9,16 €
250	CRE250 X Enduro	04-06	440649	9,16 €	440650	9,16 €
450	CRE450 F Enduro	02-03	440561	9,16 €	440650	9,16 €
450	CRE450 F Enduro	04-05	440649	9,16 €	440650	9,16 €
450	CRE450 X Enduro	04-09	440649	9,16 €	440650	9,16 €
450	CRE450 X Enduro	10-10	440649	9,16 €		
HONDA						
85	CR85	03-08			440560	9,16 €
125	CR125 R	96-03	440561	9,16 €	440560	9,16 €
125	CR125 R	04-07	440649	9,16 €	440560	9,16 €
150	CRF150 F	03-09			440560	9,16 €
150	CRF150 R (17"/14")	07-15	440561	9,16 €	440560	9,16 €
150	CRF150 RB (19"/16")	07-15	440561	9,16 €	440560	9,16 €
230	CRF230 F	03-10			440560	9,16 €
250	CR250 R	96-03	440561	9,16 €	440560	9,16 €
250	CR250 R	04-08	440649	9,16 €	440560	9,16 €
250	CRF250 R	04-06	440649	9,16 €	440650	9,16 €
250	CRF250 R	07-22	440649	9,16 €	440692	16,10 €
250	CRF250 RX	20-22	440649	9,16 €	440692	16,10 €
250	CRF250 X	04-15			440650	9,16 €
300	CRF300 RX	21-22	440649	9,16 €	440692	16,10 €
400	XR400 R	96-06	440563	9,10 €	440562	7,50 €
450	CRF450 R	02-03	440561	9,16 €	440650	9,16 €
450	CRF450 R	04-06	440649	9,16 €	440650	9,16 €
450	CRF450 R	07-20	440649	9,16 €	440692	16,10 €
450	CRF450 R	21-22			440692	16,10 €
450	CRF450 X	05-09			440650	9,16 €
500	CR500 R	95-02	440561	9,16 €	440560	9,16 €
500	XR500 R	81-85	440565	7,80 €		
500	XR500 S	80-80	440565	7,80 €		
600	XR600 R	85-87	440565	7,80 €	440229	8,60 €
600	XR600 R	88-90	440565	7,80 €	440568	8,15 €



Cyl	Modèle	Année	LEVIER GAUCHE EMBRAYAGE OU FREIN	€ T.T.C.	LEVIER DROIT FREIN	€ T.T.C.
600	XR600 R [FR]	91-00	440565	7,80 €	440568	8,15 €
650	XR650 R	00-07	440561	9,16 €	440562	7,50 €
HUSABERG						
390	FE390 Enduro	10-12	440710	33,55 €	440660	10,06 €
450	FE450	10-11	440710	33,55 €	440660	10,06 €
450	FE450	12-12	440710	33,55 €	440660	10,06 €
570	FE570 Enduro	09-10	440710	33,55 €	440660	10,06 €
HUSQVARNA						
125	CR125	02-03			440652	9,10 €
125	TE125 4T	10-13	440741	7,70 €	440715	10,06 €
125	WR125	02-04			440652	9,10 €
125	WRE125	94-06			440715	10,06 €
125	WRE125	07-10	440741	7,70 €	440715	10,06 €
250	CR250	02-04			440652	9,10 €
250	TC250	03-04	440651	17,45 €	440652	9,10 €
250	TE250	03-04	440651	17,45 €	440652	9,10 €
250	WR250	02-04			440652	9,10 €
360	WR360	02-02			440652	9,10 €
410	TE410	99-00	440741	7,70 €		
450	TC450	03-04	440651	17,45 €	440652	9,10 €
450	TE450	03-04	440651	17,45 €	440652	9,10 €
510	SMR510	04-05			440612	18,46 €
510	TE510	04-04	440651	17,45 €	440652	9,10 €
510	TE510 Centennial	04-04	440651	17,45 €	440652	9,10 €
570	TC570	02-02			440652	9,10 €
570	TE570	02-04			440652	9,10 €
610	TE610 E	98-09	440741	7,70 €	440715	10,06 €
KAWASAKI						
65	KX65	00-22	440585	9,10 €	440584	18,46 €
85	KX85	01-22	440585	9,10 €	440584	18,46 €
125	KX125	82-86	440599	9,10 €		
125	KX125	88-89	440599	9,10 €		
125	KX125	90-93	440585	9,10 €		
125	KX125	94-96	440585	9,10 €	440597	9,16 €
125	KX125	97-99	440585	9,10 €		
125	KX125	00-05	440585	9,10 €	440584	18,46 €
125	KX125	06-08	440575	9,16 €	440584	18,46 €
250	KLX250 R	94-98	440599	9,10 €	440597	9,16 €
250	KX250	82-86	440599	9,10 €		
250	KX250	88-89	440599	9,10 €		
250	KX250	90-93	440585	9,10 €		
250	KX250	94-96	440585	9,10 €	440597	9,16 €
250	KX250	97-99	440585	9,10 €		
250	KX250	00-04	440585	9,10 €	440584	18,46 €
250	KX250	05-08	440575	9,16 €	440584	18,46 €
250	KX250 F	04-04	440585	9,10 €	440584	18,46 €
250	KX250 F	05-06	440575 440665	9,16 € 23,20 €	440584	18,46 €
250	KX250 F	07-12	440575	9,16 €	440584	18,46 €
250	KX250 F	13-18	440575	9,16 €		
250	KX250 F - KX	19-19	440575	9,16 €		
300	KLX300 R	97-07	440599	9,10 €	440597	9,16 €
450	KLX450 R	07-13			440584	18,46 €
450	KX450 F	06-11	440575	9,16 €	440584	18,46 €
450	KX450 F	12-18	440575	9,16 €		
450	KX450 F Efi	09-11	440575	9,16 €	440584	18,46 €
450	KX450 F Efi	12-16	440575	9,16 €		
500	KX500	84-86	440599	9,10 €		
500	KX500	88-89	440599	9,10 €		
500	KX500	90-93	440585	9,10 €		
500	KX500	94-96	440585	9,10 €	440597	9,16 €
500	KX500	97-03	440585	9,10 €		

Cyl	Modèle	Année	LEVIER GAUCHE EMBRAYAGE OU FREIN	€ T.T.C.	LEVIER DROIT FREIN	€ T.T.C.
KAWASAKI						
500	KX500	04-04	440585	9,10 €	440584	18,46 €
650	KLX650 C	93-95	440598	8,86 €	440600	8,35 €
650	KLX650 R	93-93	440599	9,10 €		
650	KLX650 R	94-01	440599	9,10 €	440597	9,16 €
KTM						
65	SX65	01-01			440652	9,10 €
65	SX65	02-03	440653	18,50 €	440652	9,10 €
65	SX65	04-09	440651	17,45 €		
			440653	18,50 €		
85	SX85	03-12	440651	17,45 €		
125	EGS125	98-99	440651	17,45 €		
125	EXC125 Enduro	98-00	440651	17,45 €		
125	EXC125 Enduro	01-04	440651	17,45 €	440652	9,10 €
			440653	18,50 €		
125	EXC125 Enduro	05-05	440651	17,45 €	440660	10,06 €
			440653	18,50 €		
125	EXC125 Enduro	06-08	440653	18,50 €	440660	10,06 €
125	EXC125 Enduro	09-12	440710	33,55 €	440660	10,06 €
125	SX125	01-04	440651	17,45 €	440652	9,10 €
			440653	18,50 €		
125	SX125	05-08	440651	17,45 €	440660	10,06 €
			440653	18,50 €		
125	SX125	09-13	440710	33,55 €	440660	10,06 €
150	SX144	07-08	440651	17,45 €	440660	10,06 €
			440653	18,50 €		
150	SX150	09-12	440710	33,55 €	440660	10,06 €
200	EGS200	98-99	440651	17,45 €		
200	EXC200 Enduro	98-00	440651	17,45 €		
200	EXC200 Enduro	01-04	440651	17,45 €	440652	9,10 €
			440653	18,50 €		
200	EXC200 Enduro	05-08	440651	17,45 €	440660	10,06 €
			440653	18,50 €		
200	EXC200 Enduro	09-12	440710	33,55 €	440660	10,06 €
200	SX200	00-00	440651	17,45 €		
200	SX200	01-04	440651	17,45 €	440652	9,10 €
			440653	18,50 €		
200	SX200	05-05	440651	17,45 €	440660	10,06 €
			440653	18,50 €		
250	EGS250	99-99	440651	17,45 €		
250	EXC250 Enduro	99-99	440651	17,45 €		
250	EXC250 Enduro	00-00	440651	17,45 €		
			440653	18,50 €		
250	EXC250 Enduro	01-04	440651	17,45 €	440652	9,10 €
			440653	18,50 €		
250	EXC250 Enduro	05-05	440651	17,45 €	440660	10,06 €
			440653	18,50 €		
250	EXC250 Enduro	06-12	440657	23,15 €	440660	10,06 €
250	EXC250 Enduro	13-17	440657	23,15 €		
250	EXC250 Racing	02-04	440651	17,45 €	440652	9,10 €
			440653	18,50 €		
250	EXC250 Racing	05-05	440651	17,45 €	440660	10,06 €
			440653	18,50 €		
250	EXC250 Racing	06-12	440657	23,15 €	440660	10,06 €
250	EXC250 Racing	13-15	440657	23,15 €		
250	EXC250 TPI Enduro	18-22	440657	23,15 €		
250	EXC250-F Enduro	07-12	440657	23,15 €	440660	10,06 €
250	EXC250-F Enduro	13-22	440657	23,15 €		
250	EXE250 Enduro	04-04	440651	17,45 €	440652	9,10 €
			440653	18,50 €		
250	EXE250 Enduro	05-05	440651	17,45 €	440660	10,06 €
			440653	18,50 €		
250	EXE250 Enduro	06-12	440657	23,15 €	440660	10,06 €
250	SX250	01-04	440651	17,45 €	440652	9,10 €
250	SX250	05-05	440651	17,45 €	440660	10,06 €
			440653	18,50 €		
250	SX250	06-12	440657	23,15 €	440660	10,06 €
250	SX250	13-22	440657	23,15 €		



Cyl	Modèle	Année	LEVIER GAUCHE EMBAYAGE OU FREIN	€ T.T.C.	LEVIER DROIT FREIN	€ T.T.C.
250	SX250-F	05-06	440651 440653	17,45 € 18,50 €	440660	10,06 €
250	SX250-F	07-12	440657	23,15 €	440660	10,06 €
250	SX250-F	13-22	440657	23,15 €		
300	EGS300	99-99	440651	17,45 €		
300	EXC300 Enduro	99-99	440651	17,45 €		
300	EXC300 Enduro	00-00	440651 440653	17,45 € 18,50 €		
300	EXC300 Enduro	01-04	440651 440653	17,45 € 18,50 €	440652	9,10 €
300	EXC300 Enduro	05-05	440651 440653	17,45 € 18,50 €	440660	10,06 €
300	EXC300 Enduro	06-11	440657	23,15 €	440660	10,06 €
300	EXC300 Enduro	12-17	440657	23,15 €		
300	EXC300 TPI Enduro	18-22	440657	23,15 €		
350	EXC350-F	12-13	440657	23,15 €	440660	10,06 €
350	EXC350-F	14-22	440657	23,15 €		
350	SX350-F	11-12	440657	23,15 €	440660	10,06 €
350	SX350-F	13-22	440657	23,15 €		
380	EGS380	99-99	440651	17,45 €		
380	EXC380	99-99	440651	17,45 €		
380	EXC380	00-00	440651 440653	17,45 € 18,50 €		
380	EXC380	01-02	440651 440653	17,45 € 18,50 €	440652	9,10 €
380	SX380	99-99	440651	17,45 €		
380	SX380	00-00	440651 440653	17,45 € 18,50 €		
380	SX380	01-02	440651 440653	17,45 € 18,50 €	440652	9,10 €
400	EXC400	00-04	440651 440653	17,45 € 18,50 €	440652	9,10 €
400	EXC400	05-08	440651 440653	17,45 € 18,50 €	440660	10,06 €
400	EXC400	09-10	440657	23,15 €	440660	10,06 €
400	EXC400	11-14	440657	23,15 €		
400	MXC400	00-02	440651 440653	17,45 € 18,50 €	440652	9,10 €
400	SX400 Enduro	00-02	440651 440653	17,45 € 18,50 €	440652	9,10 €
400	SX400 Racing	00-01	440651 440653	17,45 € 18,50 €	440652	9,10 €
450	EXC450-F	03-04	440651 440653	17,45 € 18,50 €	440652	9,10 €
450	EXC450-F	05-06	440651 440653	17,45 € 18,50 €	440660	10,06 €
450	EXC450-F	07-11	440657	23,15 €	440660	10,06 €
450	EXC450-F	13-22	440657	23,15 €		
450	EXC450-R	07-11	440657	23,15 €	440660	10,06 €
450	EXC450-R	12-16	440657	23,15 €		
450	MXC450	03-04	440651 440653	17,45 € 18,50 €	440652	9,10 €
450	MXC450	05-06	440651 440653	17,45 € 18,50 €	440660	10,06 €
450	SMR450	04-04	440651 440653	17,45 € 18,50 €	440732	23,86 €
450	SMR450	05-07	440651 440653	17,45 € 18,50 €		
450	SMR450	08-08	440657	23,15 €		
450	SMR450	09-12	440710	33,55 €		
450	SX450 ATV	09-10	440710	33,55 €	440711	33,40 €
450	SX450 Racing	03-04	440651 440653	17,45 € 18,50 €	440652	9,10 €
450	SX450 Racing	05-06	440651 440653	17,45 € 18,50 €	440660	10,06 €
450	SX450 Racing	15-15	440657	23,15 €		
450	SX450-F	03-04	440651 440653	17,45 € 18,50 €	440652	9,10 €
450	SX450-F	05-08	440651 440653	17,45 € 18,50 €	440660	10,06 €
450	SX450-F	09-12	440710	33,55 €	440660	10,06 €
450	SX450-F	17-22	440657	23,15 €		

Cyl	Modèle	Année	LEVIER GAUCHE EMBRAYAGE OU FREIN	€ T.T.C.	LEVIER DROIT FREIN	€ T.T.C.
KTM						
450	SXS450-F	07-08	440651 440653	17,45 € 18,50 €	440660	10,06 €
450	XC450 ATV	08-08			440711	33,40 €
450	XC450 ATV	09-09	440710	33,55 €	440711	33,40 €
450	XC450-F	07-07	440651 440653	17,45 € 18,50 €	440660	10,06 €
450	XC450-F	08-09	440651 440653	17,45 € 18,50 €	440660	10,06 €
450	XC450-W /WR	09-10	440657	23,15 €	440660	10,06 €
450	XC450-W /WR	11-11	440657	23,15 €		
500	EXC500-F	12-13	440657	23,15 €	440660	10,06 €
500	EXC500-F	14-15	440657	23,15 €		
505	SX505	09-13	440657	23,15 €	440660	10,06 €
505	SX505 ATV	09-10	440710	33,55 €	440711	33,40 €
505	SX505 F Racing	07-09	440651 440653	17,45 € 18,50 €	440660	10,06 €
505	SX505 F Racing (US)	07-09	440651 440653	17,45 € 18,50 €	440660	10,06 €
505	XC505 ATV	09-13	440710	33,55 €	440711	33,40 €
505	XC505-F	09-09	440651 440653	17,45 € 18,50 €	440660	10,06 €
520	EXC520 Racing 4T (> 04/2002)	01-02	440651 440653	17,45 € 18,50 €	440652	9,10 €
520	MXC520 4T	01-02	440651 440653	17,45 € 18,50 €	440652	9,10 €
520	SX520 Racing 4T (> 04/2002)	01-02	440651 440653	17,45 € 18,50 €	440652	9,10 €
520	SX520 Racing 4T (05/2002 >)	02-02	440651 440653	17,45 € 18,50 €	440652	9,10 €
525	EXC525 Racing 4T	03-04	440651 440653	17,45 € 18,50 €	440652	9,10 €
525	EXC525 Racing 4T	05-06	440651 440653	17,45 € 18,50 €	440660	10,06 €
525	EXC525 Racing 4T	07-07	440657	23,15 €	440660	10,06 €
525	MXC525 2T	03-03	440651 440653	17,45 € 18,50 €	440652	9,10 €
525	MXC525 4T	03-04	440651 440653	17,45 € 18,50 €	440652	9,10 €
525	MXC525 4T	05-05	440651 440653	17,45 € 18,50 €	440660	10,06 €
525	SX525 Racing 2T	03-03	440651 440653	17,45 € 18,50 €	440652	9,10 €
525	SX525 Racing 4T	03-04	440651 440653	17,45 € 18,50 €	440652	9,10 €
525	SX525 Racing 4T	05-06	440651 440653	17,45 € 18,50 €	440660	10,06 €
525	XC525 ATV	08-08			440711	33,40 €
525	XC525 ATV	09-09	440710	33,55 €	440711	33,40 €
530	EXC530	09-10	440657	23,15 €	440660	10,06 €
530	EXC530	11-11	440657	23,15 €		
560	SMR560	06-07	440651 440653	17,45 € 18,50 €		
POLARIS						
400	Scrambler 4x4 400	00-02	440593	21,10 €	440381	16,06 €
400	Scrambler 4x4 400 L	95-97	440593	21,10 €	440381	16,06 €
400	Sport 400 L	94-94	440593	21,10 €	440381	16,06 €
SUZUKI						
80	RM80	82-88	440579	9,16 €		
80	RM80 (17"/14")	89-01	440579	9,16 €		
80	RM80 (19"/16")	96-01			440584	18,46 €
85	RM85 (17"/14")	05-10			440584	18,46 €
125	DR-Z 125 /L	03-09	440579	9,16 €		
125	DR-Z 125 /L	10-15	440581	9,16 €		
125	DR-Z 125 L	16-22	440581	9,16 €		
125	RM125	81-91	440579	9,16 €		
125	RM125	96-03	440583	8,75 €	440586	9,16 €
125	RM125	04-13	440583	8,75 €	440584	18,46 €
250	DR-Z 250	01-10	440581	9,16 €		
250	RM-Z 250	04-04	440585	9,10 €	440584	18,46 €



Cyl	Modèle	Année	LEVIER GAUCHE EMBRAYAGE OU FREIN	€ T.T.C.	LEVIER DROIT FREIN	€ T.T.C.
250	RM-Z 250	05-06	440575 440665	9,16 € 23,20 €	440584	18,46 €
250	RM-Z 250	07-22	440585	9,10 €	440584	18,46 €
250	RM250	82-95	440579	9,16 €		
250	RM250	96-03	440583	8,75 €	440586	9,16 €
250	RM250	04-08	440583	8,75 €	440584	18,46 €
250	RMX250	89-01	440579	9,16 €		
400	DR-Z 400 /S	00-09	440581	9,16 €	440524	9,10 €
400	DR-Z 400 E	00-03	440579 440581	9,16 € 9,16 €	440586	9,16 €
400	DR-Z 400 E	04-07	440581	9,16 €	440586	9,16 €
450	RM-Z 450	05-16	440585	9,10 €	440584	18,46 €
450	RM-Z 450	17-22	440579	9,16 €	440584	18,46 €
450	RMX450 Z	10-15	440728	-	440584	18,46 €
500	RM500	83-84	440579	9,16 €		
YAMAHA						
65	YZ 65	18-22			440584	18,46 €
80	YFM80 Raptor	02-07	440637	9,46 €		
80	YZ80	79-85	440637	9,46 €		
80	YZ80	86-92	440637	9,46 €	440638	10,06 €
80	YZ80 (17"/14")	93-94	440637	9,46 €	440638	10,06 €
80	YZ80 (17"/14")	95-01	440573	8,65 €	440582	8,10 €
80	YZ80 (19"/16")	93-94	440637	9,46 €	440638	10,06 €
80	YZ80 (19"/16")	95-95	440573	8,65 €	440638	10,06 €
80	YZ80 (19"/16")	96-00	440573	8,65 €	440582	8,10 €
80	YZ80 (19"/16")	01-01	440573	8,65 €	440584	18,46 €
85	YZ85 /LW (19"/16")	02-22	440573	8,65 €	440584	18,46 €
125	TT125 R (17"/14")	00-04	440573	8,65 €		
125	TT125 R (19"/16")	00-17	440573	8,65 €		
125	YFA125 Breeze	89-04	440635	9,16 €		
125	YFM125 Grizzly	04-13	440635	9,16 €		
125	YZ125	76-84	440637	9,46 €		
125	YZ125	85-88	440637	9,46 €	440638	10,06 €
125	YZ125	89-89	440637	9,46 €		
125	YZ125	90-93	440637	9,46 €	440580	9,16 €
125	YZ125	94-95	440573	8,65 €	440580	9,16 €
125	YZ125	96-99	440573	8,65 €	440582	8,10 €
125	YZ125	00-00	440575	9,16 €	440582	8,10 €
125	YZ125	01-07	440577	9,16 €	440584	18,46 €
125	YZ125	08-14	440577	9,16 €	440774	23,20 €
125	YZ125	15-22	440835	10,60 €	440774	23,20 €
200	WR200 R	91-97	440637	9,46 €		
250	TT250 R	99-07	440573	8,65 €	440638	10,06 €
250	WR250	89-89	440637	9,46 €		
250	WR250	90-93	440637	9,46 €	440580	9,16 €
250	WR250	94-96	440573	8,65 €	440580	9,16 €
250	WR250	97-98	440573	8,65 €	440582	8,10 €
250	WR250 F	01-02	440577	9,16 €	440584	18,46 €
250	WR250 F	03-04	440633	9,05 €	440584	18,46 €
250	WR250 F	05-10	440659 440697	50,45 € 10,06 €	440584	18,46 €
250	WR250 F	11-16	440697	10,06 €	440584	18,46 €
250	WR250 F	17-22	440697	10,06 €	440774	23,20 €
250	WR250 Z	91-91	440637	9,46 €	440580	9,16 €
250	WR250 Z	92-96	440573	8,65 €	440580	9,16 €
250	WR250 Z	97-99	440573	8,65 €	440582	8,10 €
250	WR250 Z	00-00	440575	9,16 €	440582	8,10 €
250	WR250 Z	01-05	440577	9,16 €	440584	18,46 €
250	XG250 Tricker	05-06	440637	9,46 €	440638	10,06 €
250	YFM250 R Raptor	08-13	440417	8,35 €		
250	YZ250	80-84	440637	9,46 €		
250	YZ250	85-88	440637	9,46 €	440638	10,06 €
250	YZ250	89-89	440637	9,46 €		

Cyl	Modèle	Année	LEVIER GAUCHE EMBRAYAGE OU FREIN	€ T.T.C.	LEVIER DROIT FREIN	€ T.T.C.
YAMAHA						
250	YZ250	90-93	440637	9,46 €	440580	9,16 €
250	YZ250	94-95	440573	8,65 €	440580	9,16 €
250	YZ250	96-99	440573	8,65 €	440582	8,10 €
250	YZ250	00-00	440575	9,16 €	440582	8,10 €
250	YZ250	01-07	440577	9,16 €	440584	18,46 €
250	YZ250	08-10	440577	9,16 €	440774	23,20 €
250	YZ250	11-11	440637	9,46 €	440774	23,20 €
250	YZ250	12-14	440577	9,16 €	440774	23,20 €
250	YZ250	15-22	440835	10,60 €	440774	23,20 €
250	YZ250 F	01-06	440577	9,16 €	440584	18,46 €
250	YZ250 F	07-08	440577	9,16 €	440774	23,20 €
250	YZ250 F	09-22	440775	13,90 €	440774	23,20 €
250	YZ250 X	16-19	440835	10,60 €		
350	TT350	86-97	440637	9,46 €	440638	10,06 €
350	YFM350 Bruin	04-06	440635	9,16 €		
350	YFM350 FX Wolverine	95-04	440635	9,16 €		
350	YFM350 Grizzly	07-18	440635	9,16 €		
350	YFM350 R Raptor	04-16	440635	9,16 €		
350	YFM350 X Warrior (Cour.4trous.diam.10.5)	87-88	440635	9,16 €		
350	YFM350 X Warrior (Cour.6trous.diam.8.5)	89-04	440635	9,16 €		
400	WR400 F	98-99	440573	8,65 €	440582	8,10 €
400	WR400 F	00-00	440575	9,16 €	440582	8,10 €
400	WR400 F	01-01	440577	9,16 €	440584	18,46 €
400	YFM400 FA Kodiak	00-05	440635	9,16 €		
400	YFM400 FW Big Bear Pro	00-03	440635	9,16 €		
400	YZ400 F	98-99	440573	8,65 €	440582	8,10 €
426	WR426 F	01-02	440577	9,16 €	440584	18,46 €
426	YZ426 F	00-00	440575	9,16 €	440582	8,10 €
426	YZ426 F	01-02	440577	9,16 €	440584	18,46 €
450	WR450 F	03-04	440633	9,05 €	440584	18,46 €
450	WR450 F	05-10	440659 440697	50,45 € 10,06 €	440584	18,46 €
450	WR450 F	11-11	440697	10,06 €	440584	18,46 €
450	WR450 F	12-15	440697	10,06 €	440729	13,40 €
450	WR450 F	16-22	440697	10,06 €	440774	23,20 €
450	YFM450 FA Kodiak	03-06	440635	9,16 €		
450	YFM450 FG Grizzly	07-12	440635	9,16 €		
450	YFM450 FWB Kodiak	17-19	440635	9,16 €		
450	YFM450 FX Wolverine	06-07	440635	9,16 €		
450	YZ450 F	03-07	440577	9,16 €	440584	18,46 €
450	YZ450 F	08-08	440577	9,16 €	440774	23,20 €
450	YZ450 F	09-22	440775	13,90 €	440774	23,20 €
660	YFM660 Grizzly	02-08	440637	9,46 €		
660	YFM660 Raptor	01-05	440635	9,16 €		
700	YFM700 R Raptor	06-18	440635	9,16 €		



LEVIERS

LEVER HUSQVARNA FACTORY RACING



Profile pro

Levier d'embrayage



Levier d'embrayage articulé multidirectionnel



Le Profile Pro Perch pour embrayage s'appuie sur le levier Profile avec en plus le système de levier XPS (Cross Pivot Système). Le levier XPS s'oriente dans plusieurs directions, tout en restant fin.

L'ensemble offre deux points de réglage, ce qui le rend adaptable à tous les styles de pilotage.

Profile PRO XPS perch - 024090

166,10 €
I.T.C.

Profile PRO XPS perch + STARTER - 024091

194,20 €
I.T.C.

Levier XPS

Levier de remplacement



Levier XPS noir - 024092

111,60 €
I.T.C.

Kit de réparation



Pour Profile PRO - 024093

26,00 €
I.T.C.

Profile pro

Levier de frein



XPS
CROSS PIVOT SYSTEM

Levier de frein articulé multidirectionnel

Livré complet avec roulement scellé et une molette de réglage permettant d'ajuster le levier sur une plage de 20 mm.

Profile PRO XPS perch - 024090

166,10 €
T.T.C.

Modèle	Année	Référence
HONDA		
CR85	92-07	024095
CRF150R	07-18	024095
CR125R	92-07	024095
CR250R	92-07	024095
CRF250R	02-06	024095
CRF450R	02-06	024095
CRF250X	04-12	024095
CRF450X	04-12	024095

Modèle	Année	Référence
KAWASAKI		
KX65	00-20	024096
KX85	01-13	024096
KX100	01-13	024096
KX125	00-05	024096
KX250	00-04	024096
KX250F	04-12	024096
KX450F	06-12	024096
KX500	2004	024096

Modèle	Année	Référence
KTM		
125	09-13	024097
150	09-18	024097
200EXC	10-18	024097
250SX-F	09-18	024097
250EXC	10-18	024097
300EXC	10-18	024097
350SX-F	11-18	024097
450SX-F	09-18	024097

Modèle	Année	Référence
SUZUKI		
RM85/L	02-15	024096
RM125	01-08	024096
RM250	01-08	024096
RM-Z250	04-20	024096
RM-Z450	05-20	024096
YAMAHA		
YZ85	01-20	024096

Profile

Levier d'embrayage



Standard - 024101

Standard + STARTER - 024100

75,10 €
T.T.C.

100,50 €
T.T.C.

Starter



Kit starter à chaud - 024102

27,40 €
T.T.C.

Levier

Levier de remplacement



Noir - 024104

15,20 €
T.T.C.

Argent - 024105

18,30 €
T.T.C.

Kit de réparation



Kit de réparation Profile - 024093

26,00 €
T.T.C.

Sélecteurs



Selecteur

30,40 €
I.T.C.

HONDA	RÉF.
CRF 250R (10-17)	021187
CRF 250R (18-21)	021197
CRF 250RX (20-21)	021197
CRF 450R (09-16)	021188
CRF 450R/RX (17-20)	021197
CRF 450RWE (2020)	021197
HUSQVARNA	RÉF.
TC 85 (18-20)	021196
TC 125 (14-15)	021158
TC 125 (16-22)	021196
TE 125 (14-16)	021158
TX 125 (17-22)	021196
TE 150 (17-22)	021196
FC 250 (14-15)	021158
FC 250 (16-22)	021194
FE 250 (17-22)	021194
TC 250 (14-16)	021158
TC 250 (17-22)	021193
TE 250 (14-16)	021158
TE 250 (17-22)	021193
TE 300 (14-16)	021158
TE 300 (17-22)	021193
TX 300 (17-22)	021193
FC 350 (14-15)	021158
FC 350 (16-22)	021194
FE 350 (17-22)	021194
FX 350 (17-22)	021194
FC 450 (16-22)	021195
FC 450 Rockstar 2218	021195
FE 450 (17-22)	021195
FS 450 (16-22)	021195
FX 450 (17-22)	021195
FE 501 (17-22)	021195

KAWASAKI	RÉF.
KX 60 (86-03)	021161
KX 80 (91-00)	021161
KX 85 (01-20)	021161
KX 100 (95-09, 11-20)	021161
KX 125 (88-93)	021161
KX 250 (88-93)	021161
KX 250 (19-21)	021185
KX 250F (09-18)	021185
KX 450 (19-22)	021191
KX 450F (16-18)	021191
KX 500 (88-93)	021191
KTM	RÉF.
125 EXC (01-16)	021158
125 SX (01-15)	021158
125 SX (16-22)	021196
125 XC-w (17-22)	021196
144 SX (07-08)	021158
150 SX (09-15)	021158
150 SX (16-22)	021196
150 XC (10-15)	021158
150 XC-w (17-22)	021196
250 EXC (01-16)	021158
220 MXC (01-03)	021158
220 SX (03-04)	021158
220 XC (06-10)	021158
220 XC-W (06-16)	021158
250 EXC (01-03, 05-16)	021158
250 EXC (17-22)	021193
250 EXC-F (06-11)	021158
250 EXC-F (17-22)	021194
250 MXC (2201)	021158
250 SX (01-02, 05-16)	021158
250 SX (17-22)	021193

KTM	RÉF.
250 SX-F (05-10, 13-15)	021158
250 SX-F (16-22)	021194
250 SX-F Factory (15-17)	021194
250 XC (06-16)	021158
250 XC (17-22)	021193
250 XC-F (07-10, 13-15)	021158
250 XC-F (16-22)	021194
250 XC-W (06-16)	021158
250 XC-W (17-22)	021193
250 XC-W (06-11)	021158
300 EXC (01-03, 05-16)	021158
300 EXC (17-22)	021193
300 MXC (01-03, 2205)	021158
300 XC (06-16)	021158
300 XC (17-22)	021193
300 XC-W (06-16)	021158
300 XC-W (17-22)	021193
350 EXC-F (17-22)	021194
350 SX-F (11-15)	021158
350 SX-F (16-22)	021194
350 XC-F (11-15)	021158
350 XC-F (16-22)	021194
380 EXC (01-02)	021158
380 MXC (2201)	021158
380 SX (01-02)	021158
450 EXC-F (17-22)	021195
450 SMR (08-12)	021158
450 SX-F (07-12)	021158
450 XC-F (08-12)	021158
500 EXC-F (17-22)	021195
505 SX-F (07-08)	021158

SUZUKI	RÉF.
RM 60 (2003)	021161
RM-Z 450 (08-21)	021180
YAMAHA	RÉF.
YZ80 (93-01)	021179
YZ85 (02-21)	021179
YZ125 (05-21)	021172
WR250F (20-21)	021192
YZ250 (05-21)	021172
YZ250X (16-21)	021172
YZ250F (14-18)	021190
YZ250F (19-21)	021192
YZ250FX (15-21)	021190
WR450F (16-18)	021190
WR450F (19-21)	021192
YZ450F (14-17)	021190
YZ450F (18-21)	021192
YZ450FX (16-18)	021190
YZ450FX (19-21)	021192



GUIDONS



SP *PROTAPER* **SPORT**™

Mousse de guidon incluse
Monte sur pontets de 22mm

Guidons PROTAPER SPORT

45,20 €
T.T.C.



Unadilla



Washougal



ATV



Mini

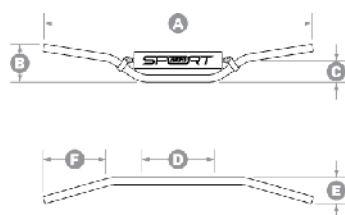

Désignation	Référence	Dimensions en mm						
		Noir	A	B	C	D	E	F
Unadilla	021142		800	95	67	233	60	190
Washougal	021141		800	99	69	243	54	190
ATV	021147		813	160	104	236	100	215
Mini	021146		730	117	89	166	50	195



71,10 €
i.t.c.



Seven Eighths, ultra résistant.

Guidon Pro Taper SE 22 mm est fabriqué avec un alu 2014 de 5 mm d'épaisseur ultra résistant utilisé dans l'aérospatial. Côté embrayage moleté offre une meilleure adhérence de la main.

Mousse de guidon incluse - Monte sur pontets de 22mm



Pit Bike

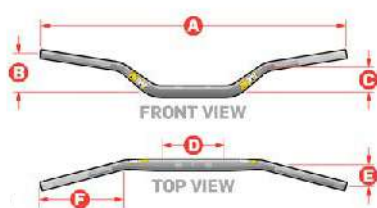

Désignation	Référence		Dimensions en mm					
	Noir	Platinum	A	B	C	D	E	F
Carmichael	025296		800	77	40	188	56	206
Henry/Reed	025242		800	92	60	225	57	186
Windham/RM MID	025250		800	99	69	243	54	189
CR MID	025244		800	82	56	230	57	195
YZ LOW	025253		800	67	48	219	70	195
Kawasaki Mini	025259		730	94	81	176	50	186
Yamaha Mini	025261		730	99	70	160	58	186
Schoolboy PRO	025381		745	80	72	200	52	200
KTM50	025263		648	80	72	157	44	167
XR50/CRF50 - PIT BIKE	025262	025284	724	171	152	184	44	161
KLX110/DRZ110 - PIT BIKE	025302		800	143	123	184	44	200

Micro Handlebars



Kit School Boy Pro - 025035 142,50 €
i.t.c.



Kit KTM 50 - 025038 142,50 €
i.t.c.



Guidon Mini Racer - 021338 38,60 €
i.t.c.

Les guidons pour les petits

Le guidon Micro utilise un diamètre plus petit dans les zones de la poignée, tout en conservant un diamètre de 22 mm dans toutes les zones de serrage et de contrôle. Le kit comprend les pièces nécessaires à la conversion. Simple à installer sur tous smodèles minibike 2T 85cc et plus petit.



Kit Tube accélérateur - 025044 70,70 €
i.t.c.



Poignées Micro - 025045 9,70 €
i.t.c.

Désignation	Référence	€ T.T.C.
Kit Micro Handelbar Schoolboy Pro	025035	142,50 €
Kit Micro Handelbar KTM 50	025038	142,50 €
Kit Micro Throttle tube	025044	70,70
Poignées Micro waffle grises	025045	9,70



BEST-SELLER

Le Guidon Pro Taper Contour est spécialement conçu pour le Motocross et l'Enduro. Côté embrayage moleté offre une meilleure adhérence de la main.

Mousse de guidon incluse - Monte sur pontets de 28,6mm

Désignation	€ T.T.C.	Référence				Dimensions en mm (voir schéma en bas de page)					
		Noir	Orange	Bleu	Rouge	A	B	C	D	E	F
Carmichael	105,60	027909 022041*	027993 022066*		027991	800	77	40	195	55	180
Henry/Reed	105,60	027925	027996	027995 022068*	027994	800	92	66	206	57	180
Windham/RM MID	105,60	027953 022052*	027987		027985 022058*	800	99	74	219	53	180
Factory Suzuki/KTM Stock	105,60	027921				800	92	62	217	47	180
Woods HIGH	116,70	027957				800	95	66	211	57	180
CR HIGH	105,60	027913 022045*	027990		027988	800	95	67	204	60	200
YZ HIGH	105,60	027965 022055*				800	84	53	202	52	180
Mini LOW	105,60	027937				775	80	53	216	50	200
Mini HIGH	105,60	027933				775	105	76	221	52	200
Pastrana FMX	105,60	027941				800	121	70	236	55	190
ATV LOW	105,60	027970				813	95	67	229	60	200

Contour noir 105,60 € T.T.C.

Contour couleur 116,70 € T.T.C.



Guidon profilé

Guidon sans barre haut de gamme de chez PRO TAPER. Ce guidon cross a été conçu avec des alliages ultramodernes afin d'offrir un maximum de précision et de feeling pour le pilote. Côté embrayage moleté offre une meilleure adhérence de la main.

Mousse de guidon non incluse

Monte sur pontets de 28,6mm

EVO noir 133,00 € T.T.C.

Désignation	€ T.T.C.	Référence Noir	Dimensions en mm (voir schéma en bas de page)					
			A	B	C	D	E	F
Carmichael	133,00	024003 022037*	800	77	40	195	55	180
Henry/Reed	131,00	024002	800	92	66	206	57	180
Windham/RM MID	133,00	024004 022048*	800	99	74	219	53	180

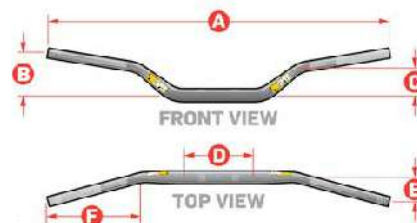

FUZION™

DUAL FUNCTION HANDLEBAR

218,30 €
T.T.C.

Un contrôle de haute performance

Le verrouillage flexible du guidon Fuzion permet aux pilotes de choisir entre : plus rigide (sensation de mieux contrôler le guidon) et moins rigide (sensation d'absorption des chocs, selon les conditions du terrain).

Modification de la barre de « verrouillé » à « déverrouillé » ne prend que quelques secondes. Le guidon utilise un alliage d'aluminium profilé offrant une grande résistance. Côté embrayage moleté offre une meilleure adhérence de la main.

975 grammes - Mousse de guidon incluse - Monte sur pontets de 28,6mm

Désignation	Référence	Dimensions en mm					
		A	B	C	D	E	F
Carmichael	028958	800	73	36	195	55	210
Henry/Reed	028959	800	92	61	206	57	182
Windham/RM MID	028960	800	99	70	219	53	180
CR HIGH	028961	800	95	67	204	60	180
YZ HIGH	028962 022074*	800	84	53	202	52	190
SX Race	028963	800	87	54.5	216	54	195

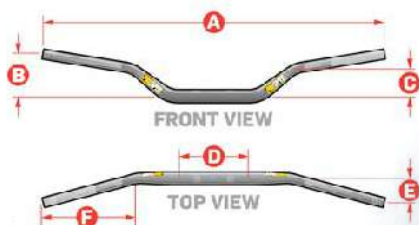

MOUSSES DE GUIDON



Mousse de guidon
chrono intégré

32,90 €
T.T.C.

NOUVEAUTÉ



Chronomètre, minuteur, alarme et horloge !



Chrono intégré - 88MOUSSCHRON



Mousse de guidon horloge intégrée

26,90 €
T.T.C.

NOUVEAUTÉ



Rouge - 88MOUSSHORLR



Bleue - 88MOUSSHORLB



Noir - 88MOUSSHORLN



Orange - 88MOUSSHORLO



Orange - 88MOUSSHORLBC 29,90 €
T.T.C.

Cylindrique

Horloge intégrée

Noire - 88MOUSSHORLCN

32,90 €
T.T.C.

NOUVEAUTÉ



2.0 Square

24,90 €
T.T.C.

Guidons sans barre



Rouge - 021624

- | | |
|---|--|
|  Stealth - 021630 |  Rose - 021629 |
|  Jaune - 021626 |  Orange - 021627 |
|  Vert - 021628 |  Bleu - 021625 |
|  Jaune fluo - 021631 | |

Placeholder

16,20 €
T.T.C.

Guidons avec barre



Race orange

25,4 cm - 021644
20,3 cm - 021651

- | | |
|--|--|
|  25,4 cm - 028329 |  25,4 cm - 021641 |
|  20,3 cm - 028333 |  20,3 cm - 021648 |
|  25,4 cm - 028330 |  25,4 cm - 021645 |
|  20,3 cm - 021642 |  20,3 cm - 021646 |
|  25,4 cm - 021643 |  20,3 cm - 021653 |
|  20,3 cm - 021650 | |

Pontets

59,90 €
T.T.C.



Adaptateurs

Ø 22 - Ø 28,6 - 022821



Montage silent bloc

Contour, Evo et Fuzion - 022822

Fuzion

33,50 €
T.T.C.

Guidons Fuzion



Noir - 028401



Kit réparation - 022885

7,60 €
T.T.C.

Crochet de départ

177,90 €
T.T.C.

Self-Engaged Launch Assist (SELA)

SELA™
SELF-ENGAGED LAUNCH ASSIST



Contrôle de lancement autonome révolutionnaire de ProTaper. Avec son cadran rotatif auto-engagé, SELA peut être facilement réglé sans aucune aide, offrant aux pilotes la liberté de départ par eux-mêmes.

Lors d'un démarrage, SELA permet de comprimer temporairement la suspension avant de la moto, réduisant sa tendance au wheeling en accélération.

020202

Les composants :

1. Ensemble de cadran rotatif auto-engagé en instance de brevet / 2. Anneau récepteur à double charnière avec diamètre de serrage variable / 3. Récepteur A (Honda, Husqvarna, Kawasaki, KTM, Yamaha) / 4. Récepteur B (Suzuki) / 5. Entretoises de récepteur spécifiques au modèle / 6. F uide frein-filet / 7. Outils d'installation et de montage / 8. Vis d'assemblage spécifiques au modèle / 9. Guide de perçage en aluminium (non illustré)



POIGNÉES



ZIÉROSCOPHE

RECREATIVE ENTRY MOTORCYCLES FACTORY RACING

Clamp on

27,90 €
T.T.C.

Triple densité



Fluo bleu noir - 021656



Fluo rose
021655



Fluo jaune
021657



Fluo vert
021658



Fluo rouge
021660



Fluo orange
021661



Gris
021666



Blanc
021667



Tout noir
021668



Gris gris
021669



Blanc blanc
021670

Neon

17,80 €
T.T.C.

Simple densité



Néon rose
024040

17,50 €
T.T.C.



Néon vert
024041 17,80 €
T.T.C.



Néon bleu
024038 17,50 €
T.T.C.



Néon jaune
024039 17,50 €
T.T.C.



Néon blanc
024034 17,10 €
T.T.C.

Pillow

Triple densité

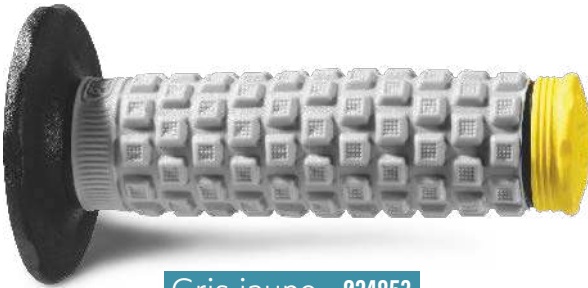

Gris jaune - 024853

19,30 €
T.T.C.

- Gris bleu
024852
- Noir bleu
024885
- Gris vert
024854
- Noir vert
024887
- Gris orange
024855
- Noir orange
024888
- Gris noir
024858
- Noir noir
024891
- Gris rouge
024851
- Noir rouge
024884
- Gris jaune
024853
- Noir jaune
024886

Pillow

Simple densité



- Gris foncé
024843
- Noir
024845

11,20 €
T.T.C.

Sport

Simple densité



Gris
021149



Noir
021148



9,60 €
T.T.C.



POIGNÉES



708 lock on

30,95 €
I.T.C.

Double densité - L 115 mm Ø 22-25 mm



Jaune fluo Bleu électrique - 708JFBC



ADAPTATEURS FOURNIS



709 lock on

29,95 €
I.T.C.

Double densité - L 115 mm Ø 22-25 mm



Rouge - 709R



ADAPTATEURS FOURNIS



788 fluo

Triple densité - L 115 mm Ø 22-25 mm

29,90 € I.T.C.



Orange fluo jaune fluo bleu clair - 7880FJBC

- Orange fluo jaune fluo noir - 7880FJFN
- Rouge jaune fluo noir - 788RJFN
- Orange fluo bleu noir - 7880FBN
- Orange fluo bleu blanc - 7880FBBL
- Gris jaune fluo noir - 788GJFN
- Bleu clair jaune fluo noir - 788BCJFN
- Bleu clair jaune fluo blanc - 788BCJFBL
- Jaune fluo noir blanc - 788JFNBL
- Orange fluo bleu bleu clair - 7880FBBC
- Rouge jaune fluo noir - 788RJFN

788 base couleur

Triple densité - L 115 mm Ø 22-25 mm

29,90 € I.T.C.



Rouge noir gris - 788RGN

- Orange noir gris - 7880GN
- Vert noir gris - 788VGN
- Gris foncé noir gris - 788GFGN
- Jaune noir gris - 788JGN
- Bleu noir gris - 788BGN

788 édition spéciale

Triple densité - L 115 mm Ø 22-25 mm

29,90 € I.T.C.



Blanc bleu jaune - 788BLBJ

- Blanc bleu rouge - 788BLRB
- Blanc rouge bleu - 788BLBR
- Blanc rouge bleu clair - 788BLRBC
- Blanc bleu bleu clair - 788BLBBC
- Noir blanc titanium - 788NBLT
- Blanc rouge vert fluo - 788BLRVF

788 base grise

Triple densité - L 115 mm Ø 22-25 mm

29,90 € I.T.C.



Gris noir rouge - 788GRN

- Gris noir orange - 788GON
- Gris noir vert - 788GVN
- Gris noir gris foncé - 788GGT
- Gris noir bleu - 788GBN
- Gris noir jaune - 788GJN

788 blanche

29,90 €
T.T.C.

Triple densité - L 115 mm Ø 22-25 mm



Blanc orange fluo noir - 788BLOFN

- Blanc vert fluo noir - 788BLVFN
- Blanc rose fluo noir - 788BLPFN
- Blanc rouge fluo noir - 788BLRFN
- Blanc jaune fluo noir - 788BLJFN
- Blanc bleu fluo noir - 788BLBFN
- Blanc noir titanium - 788BLNT

790

28,90 €
T.T.C.

Triple densité - L 115 mm Ø 22-25 mm



Gris jaune noir - 790GNJ

- Gris bleu noir - 790GNB
- Gris vert noir - 790GNV
- Gris titanium noir - 790GNT
- Gris rouge noir - 790GNR
- Gris orange noir - 790GNO
- Noir jaune gris - 790NGJ
- Noir rouge gris - 790NGR
- Noir vert gris - 790NGV

791

22,95 €
T.T.C.

Double densité - L 115 mm Ø 22-25 mm



Gris noir - 791GN

- Rouge noir - 791RN
- Orange noir - 791ON
- Bleu noir - 791BN
- Jaune noir - 791JN
- Vert noir - 791VN

791 fluo

22,95 €
T.T.C.

Double densité - L 115 mm Ø 22-25 mm



Blanc fuchsia - 791BLFF

- Blanc vert fluo - 791BLVF
- Blanc orange fluo - 791BLOF
- Blanc jaune fluo - 791BLJF
- Jaune fluo bleu - 791IJFB
- Orange fluo noir - 791IOFN
- Orange fluo bleu - 791IOFB



801 noire

Double densité - L 115 mm Ø 22-25 mm

25,15 €
T.T.C.



Noir orange - 801NO



Noir rouge - 801NR



Noir jaune - 801NJ



Noir vert - 801NV



Noir gris - 801NG



Noir bleu - 801NB



Noir bleu clair - 801NBC

801 fluo

Double densité - L 115 mm Ø 22-25 mm

25,15 €
T.T.C.



Jaune fluo noir - 801JFN



Vert fluo noir - 801VFN



Orange fluo noir - 801OFN



Fuchsia fluo noir - 801FFN



Jaune fluo bleu - 801JFB

801 grise

Double densité - L 115 mm Ø 22-25 mm

25,15 €
T.T.C.



Gris rouge - 801GR



Gris noir - 801GT



Gris bleu - 801GB



Gris vert - 801GV



Gris jaune - 801GJ



Gris orange - 801GO

801 blanche

Double densité - L 115 mm Ø 22-25 mm

25,15 €
T.T.C.



Blanc vert fluo - 801BLVF



Blanc orange fluo - 801BLOF



Blanc noir - 801BLN



Blanc fuchsia fluo - 801BLFF



Blanc jaune fluo - 801BLJF









794

Simple densité - L 115 mm Ø 22-25 mm

Fluo 17,45 €
I.T.C.
Couleur 16,35 €
I.T.C.



Orange fluo - 794FO

- | | |
|---|--|
|  Jaune fluo - 794FI |  Noir - 794N |
|  Fuchsia fluo - 794FF |  Blanc - 794BL |
|  Vert fluo - 794FV |  Gris - 794G |
|  Bleu - 794B |  Vert - 794V |
|  Orange - 794O |  Rouge - 794R |



795

Simple densité - L 115 mm Ø 22-25 mm

16,65 €
T.T.C.



Noir - 795N

799

Simple densité - L 115 mm Ø 22-25 mm

25,15 €
T.T.C.



Orange noir - 7990N

Orange bleu - 7990B Orange rouge - 7990R

Orange gris - 7990G

792

Simple densité - L 115 mm Ø 22-25 mm

14,40 €
T.T.C.



Noire - 792N

727 ATV/jetski

Double densité - L 125 mm Ø 22 mm

23,15 €
T.T.C.



Orange noir - 7270N

726 ATV/jetski

Simple densité - L 125 mm Ø 22 mm

16,80 €
T.T.C.



Noire - 726N

964 ATV/jetski

Double densité - L 120 mm Ø 22 mm

13,45 €
T.T.C.



Jaune noir - 964JN

Rouge noir - 964RN

Bleu noir - 964BN

Gris noir - 964GN

Vert noir - 964VN

785 Rally raid Mousse

L 135 mm Ø 22-25 mm

19,90 €
I.T.C.



Noir - 785N

786 Rally raid Mousse

L 125 mm Ø 22-25 mm

26,05 €
I.T.C.



Noir - 786N

714 Rally raid

L 125 mm Ø 22-25 mm

19,90 €
I.T.C.



Noir - 714N

737 Rally raid

L 125 mm Ø 22-25 mm

14,60 €
I.T.C.



Noir - 737N

Accessoires

Butée de poignée

8,75 €
I.T.C.



Bleu - 5002B

Gris - 5002G

Noir - 5002N

Orange - 5002O

Rouge - 5002R

Vert - 5002V

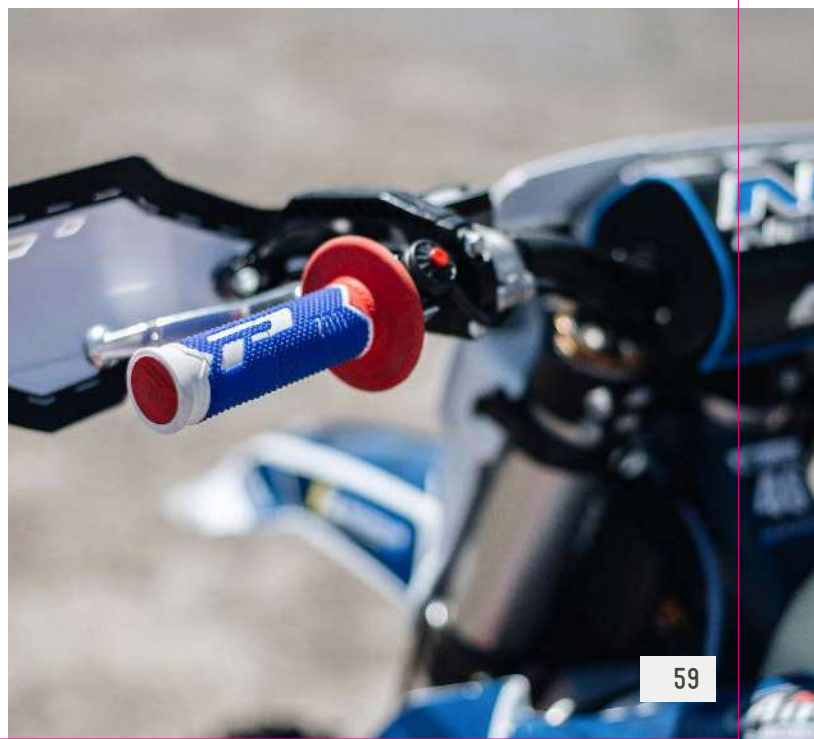



WAVE

R20 LOCK-ON GRIPS



WAFFLE

R20

NOUVEAUTÉ

LOCK-ON GRIPS 27,95 € T.T.C.

Installation facile grâce au système Lock-On

Performances antidérapantes garanties dans toutes les conditions

Diamètre ø28.5mm pour une sensation de conduite maximale, tube d'accélérateur inclus avec réglage multiposition

Écroux en acier inoxydable

8 cames d'accélérateur différentes incluses pour un montage toutes marques, plus 3 cames spécifiques pour les modèles Beta (1 pour 2T, 1 pour 4T et 1 pour 4T avec une réponse plus rapide)

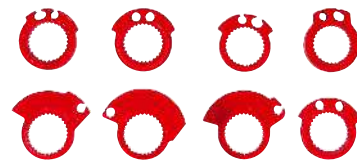

8 different throttle cams included
8 diverse camme incluse

R20 LOCK-ON WAVE



Pour BETA RR 125 > 530 avec 3 cames spécifiques

R20 LOCK-ON WAFFLE



Pour BETA RR 125 > 530 avec 3 cames spécifiques



FLYING MACHINE FACTORY

Dans ce sport, le cœur d'un coureur bat dans chaque innovation. En 1973, Don Emler crée FMF par désir d'aller plus vite. Depuis près de cinquante ans, FMF est le leader dans la poursuite de la précision, de la puissance et de la vitesse. Maintenant, notre mission s'élargit : FMF VISION, une marque d'optique unique et autonome créée en partenariat avec les brillants esprits de chez 100% !

NOUVEAUTÉ



**POWERBOMB
OSBORNE**

ÉQUIPEMENT DU PILOTE

SPORTSWEAR /
MASQUES /
LUNETTES DE SOLEIL /
CASQUES /
INTERCOMS /



SENA

SPORTSWEAR UP	64
MASQUES FMF	70
SOLAIRES FMF	84
MASQUES PROGRIP	88
CASQUES PROGRIP	106
INTERCOMS SENA	110

SPORTSWEAR



Sweat capuche

Original, épais et chaud !



Sweat à capuche

- S **88HBS**
- M **88HBM**
- L **88HBL**
- XL **88HBXL**
- XXL **88HBXXL**

48,90 €
T.T.C.

Logo en feutrine brodé
Fermeture éclair renforcée
Coupe fluide
60% Coton, 33% Polyester



T-shirts et polo

Bien coupés et robustes.



Manches longues

M **88TSMBLM**
 L **88TSMBLL**
 XL **88TSMBLXL**
 XXL **88TSMBLXXL**

30,90 € t.t.c.

Logo imprimé
 Col rond
 Coupe fluide
 100% Coton



Manches courtes

S **88TSMCBLS**
 M **88TSMCBM**
 L **88TSMCBLL**
 XL **88TSMCBLXL**
 XXL **88TSMCBLXXL**
 Femme M **88TSFMCBLM**
 Enfant 8/10 **88TSEM CBLO8**

21,90 € t.t.c.

Logo imprimé
 Col rond
 Coupe fluide
 100% Coton



Polo

S **882001**
 M **882002**
 L **882003**
 XL **882004**
 XXL **882005**

32,90 € t.t.c.

Logo imprimé poitrine
 Col trois boutons
 Coupe fluide
 100% Coton

Maillot

M 885001
L 885002
XL 885003
XXL 885004

26,90 €
I.T.E.
Logo imprimé
Col rond
Coupe fluide
100% Polyester



Veste sans manche



M 883001
L 883002
XL 883003
XXL 883004

54,90 €
I.T.E.
Logo brodé
Col haut
Coupe fluide
Fermeture éclair
50% Coton, 50% Polyester

Doudoune



M 884001
L 884002
XL 884003
XXL 884004

76,90 €
I.T.E.
Logo brodé
Col haut
Coupe fluide
100% polyester,
rembourrage synthétique

Couvre-chefs

Casquette et bonnets



Bonnet

881001

Logo imprimé et brodé
 Doublé polaire
 Taille unique
 100% Polyester

16,90 € T.T.C.



Casquette

881002

Filet au dos
 Réglage pression
 Visière : 7 cm
 Hauteur de tête : 10.5 cm
 60% coton 40% polyester

21,90 € T.T.C.



ÉQUIPEMENT
DU PILOTE



NOUVEAUTÉ

 **Bluetooth®**

Bonnet Bluetooth®

88BONNET

Logo imprimé et brodé
 Doublé polaire
 Taille unique
 100% Polyester
 Écouteurs intégrés
 Éco taxe 0,02€

24,90 € T.T.C.

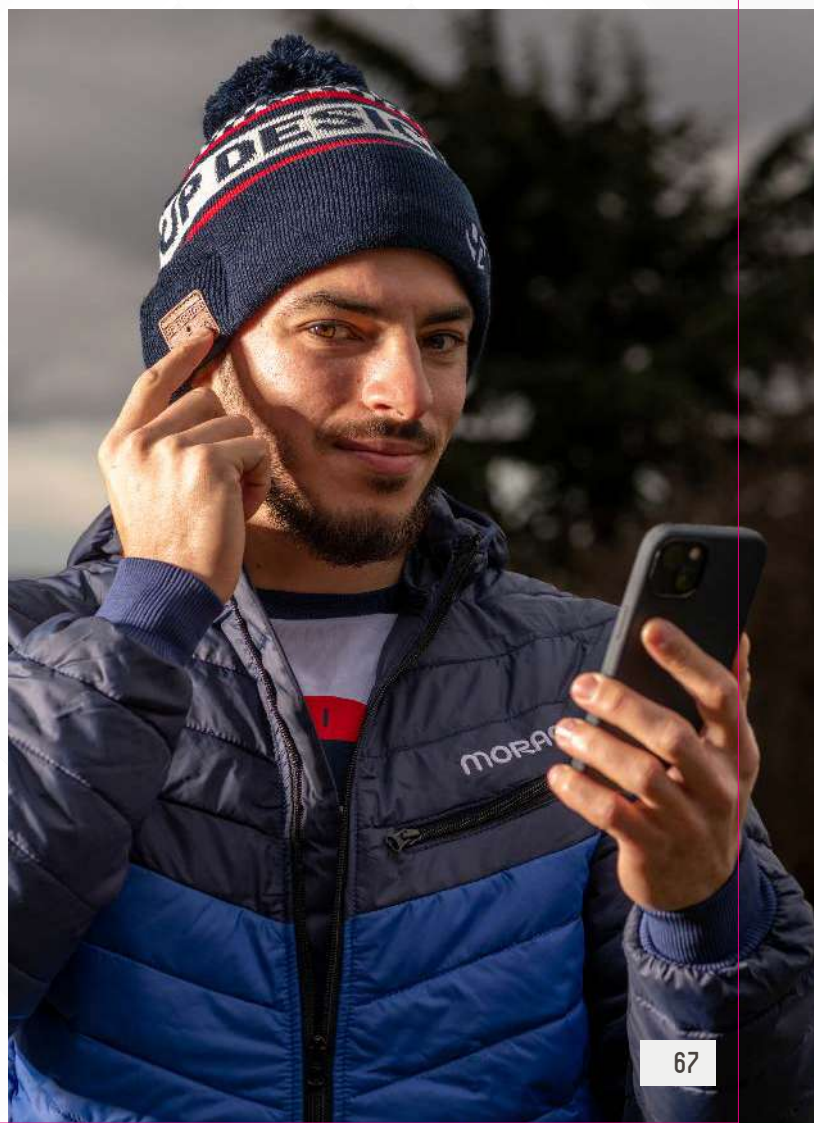

Gilet Bodywarmer 86,90 € T.T.C.

NOUVEAUTÉ

Le gilet Bodywarmer vous apportera le style et le confort avec un tissu imperméable et des zips étanches. Vous pourrez le porter en appoint dessous comme sur une autre veste. La petite poche arrière n'est pas faite pour mettre votre gibier, mais vous pourrez y mettre un bonnet, tour de cou Up DESIGN ou votre masque FMF.

100% polyester • enduction • doublure mesh • zips étanches

S	883100
M	883101
L	883102
XL	883103



Veste Corporate Paddock 97,90 € T.T.C.

S	886000
M	886001
L	886002
XL	886003

NOUVEAUTÉ

Cette veste a été conçue pour être légère et imperméable.

Le tissu est enduit et les zips sont étanches afin de mieux résister aux intempéries.

Nous avons soigné les détails afin de la rendre confortable avec une protection du menton en haut du zip, une petite visière sur la capuche, une poche au niveau de l'avant bras et un serrage en bas de la veste et sur la capuche. Sans oublier le serrage au niveau des poignets et la poche intérieure.

Tellement confortable et légère que vous oublierez même l'avoir sur vous !

100% polyester • enduction • doublure mesh • zips étanches

Tour de cou

16,90 €
I.T.C.

NOUVEAUTÉ



88TDC01
Respirant
Séchage rapide
100% Polyester



ÉQUIPEMENT
DU PILOTE



Porte clé

5,40 €
I.T.C.

88CLE
Caoutchouc souple
Anneau et chaînette



MASQUES



POWERBOMB

Avec le modèle Zach OSBORNE, vous porterez un regard de champion sur la piste !

POWERBOMB Zach OSBORNE

NOUVEAUTÉ

- Protège-nez amovible
- Écran polycarbonate antibuée maintenu au cadre par 9 points de fixation
- Mousse triple couche
- Strap 45mm avec silicone
- Écran transparent inclus



POWERBOMB ZO - F-50200-251-07

Écran miroir rouge

62,90 €
T.T.C.

POWERBOMB TALLADEGA



NOUVEAUTÉ



Miroir- F-50037-000-08 Écran miroir bleu

59,90 €
T.T.C.

Transparent- F-50036-000-08

49,90 €
T.T.C.

POWERBOMB ROCKET LIME



NOUVEAUTÉ



Miroir- F-50037-000-07 Écran miroir vert

59,90 €
T.T.C.

Transparent- F-50036-000-07

49,90 €
T.T.C.



Tous les masques adultes FMF Vision utilisent les mêmes écrans et les mêmes tear-offs.

Tous les accessoires FMF Vision sont compatibles avec la première génération de masques de la marque 100%.

POWERBOMB US OF A



Miroir- F-50200-253-07 Écran miroir or réaliste

59,90 €
I.T.C.

Transparent- F-50200-101-07

49,90 €
I.T.C.

POWERBOMB SPARK



Miroir- F-50200-251-06 Écran miroir rouge

59,90 €
I.T.C.

Transparent- F-50200-101-06

49,90 €
I.T.C.



Tous les masques adultes FMF Vision utilisent les mêmes écrans et les mêmes tear-offs.

Tous les accessoires FMF Vision sont compatibles avec la première génération de masques de la marque 100%.

POWERBOMB ROCKET WHITE



Miroir- F-50200-253-00 Écran miroir or réaliste

59,90 €
I.T.C.

POWERBOMB ROCKET BLACK



Miroir- F-50200-252-01 Écran miroir argent

59,90 €
I.T.C.

Transparent- F-50200-101-01

49,90 €
I.T.C.

POWERBOMB ROCKET BLUE



Miroir- F-50200-250-02 Écran miroir bleu

59,90 €
I.T.C.

POWERBOMB ROCKET ORANGE



Miroir- F-50200-252-05 Écran miroir argent

59,90 €
I.T.C.

Transparent- F-50200-101-05

49,90 €
I.T.C.

Tous les masques adultes FMF Vision utilisent les mêmes écrans et les mêmes tear-offs.

Tous les accessoires FMF Vision sont compatibles avec la première génération de masques de la marque 100%.

POWERBOMB ENDURO

*Double écran en polycarbonate anti buée
Protège-nez amovible
Supports pour Tear-offs*

ROCKET BLACK



Transparent- F-50202-501-01 Double écran 59,90 €
T.T.C.

ROCKET BLUE



Transparent- F-50202-501-02 Double écran 59,90 €
T.T.C.

ROCKET ORANGE



Transparent- F-50202-501-05 Double écran 59,90 €
T.T.C.



POWERBOMB FILM SYSTEM

Cadre élargi, ajustement facile pour lunettes
Poches avec mousse pour soulager les branches des lunettes
Mousse du pont de nez élargie pour un ajustement facile
Protège-nez amovible
Supports pour Tear-offs



Transparent- F-50220-901-01

75,90 €
i.t.c.

POWERBOMB OTG

Cadre élargi, ajustement facile pour lunettes
Poches avec mousse pour soulager les branches des lunettes
Mousse du pont de nez élargie pour un ajustement facile
Protège-nez amovible
Supports pour Tear-offs



Transparent- F-50204-101-01

59,90 €
i.t.c.

Tous les masques adultes FMF Vision utilisent les mêmes écrans et les mêmes tear-offs.

Tous les accessoires FMF Vision sont compatibles avec la première génération de masques de la marque 100%.

POWERBOMB ENFANT

La même qualité adaptée à la morphologie des plus jeunes.

ROCKET BLACK



Miroir- F-50300-252-01 Écran miroir argent **46,90 €**
T.T.C.

Transparent- F-50300-101-01 **35,90 €**
T.T.C.

ROCKET BLUE



Miroir- F-50300-250-02 Écran miroir bleu **46,90 €**
T.T.C.

ROCKET ORANGE



Miroir- F-50300-252-05 Écran miroir argent **46,90 €**
T.T.C.

FILM SYSTEM

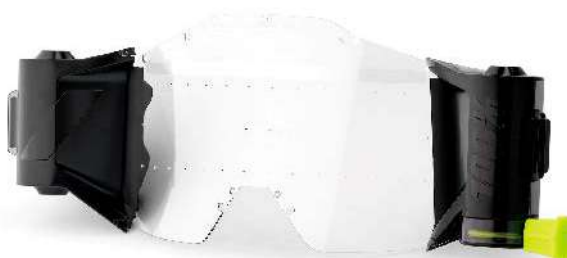

Pour POWERBOMB enfant- F-51221-500-01 **49,00 €**
T.T.C.





Tous les masques adultes FMF Vision utilisent les mêmes écrans et les mêmes tear-offs.

Tous les accessoires FMF Vision sont compatibles avec la première génération de masques de la marque 100%.



POWERCORE

Robuste et fiable à 100%

CORE CYAN



NOUVEAUTÉ



Miroir- F-50051-000-04 Écran miroir bleu

39,90 €
I.T.C.

Transparent- F-50050-000-04

29,90 €
I.T.C.

CORE WHITE



NOUVEAUTÉ



Miroir- F-50051-000-05 Écran miroir rouge

39,90 €
I.T.C.

Transparent- F-50050-000-05

29,90 €
I.T.C.

CORE BLACK



Miroir- F-50400-252-01 Écran miroir argent 39,90 €
I.T.C.

Transparent- F-50400-101-01 29,90 €
I.T.C.

FLAME NAVY



Miroir- F-50400-250-02 Écran miroir bleu 39,90 €
I.T.C.

Transparent- F-50400-101-02 29,90 €
I.T.C.

CORE YELLOW



Miroir- F-50400-259-04 Écran miroir or 39,90 €
I.T.C.

FLAME RED



Miroir- F-50400-251-03 Écran miroir rouge 39,90 €
I.T.C.

ASSAULT CAMO



Miroir- F-50400-252-08 Écran miroir argent 39,90 €
I.T.C.

Transparent- F-50400-101-08 29,90 €
I.T.C.

ASSAULT GREY



Miroir- F-50400-252-09 Écran miroir ARGENT 39,90 €
I.T.C.

Transparent- F-50400-101-09 29,90 €
I.T.C.

Tous les masques adultes FMF Vision utilisent les mêmes écrans et les mêmes tear-offs.

Tous les accessoires FMF Vision sont compatibles avec la première génération de masques de la marque 100%.

POWERCORE ENFANT

NOUVEAUTÉ

CORE CYAN



Miroir- F-50055-000-05 Écran miroir argent **39,90 €** I.T.C.

Transparent- F-50054-000-05 **29,90 €** I.T.C.

NOUVEAUTÉ

CORE WHITE



Miroir- F-50055-000-06 Écran miroir ROUGE **39,90 €** I.T.C.

Transparent- F-50054-000-06 **29,90 €** I.T.C.

CORE BLACK



Miroir- F-50500-252-01 Écran miroir or **39,90 €** I.T.C.

Transparent- F-50500-101-01 **29,90 €** I.T.C.

FLAME RED



Miroir- F-50500-251-03 Écran miroir rouge **39,90 €** I.T.C.

CORE YELLOW



Miroir- F-50400-252-08 Écran miroir argent **39,90 €** I.T.C.

ASSAULT GREY



Miroir- F-50500-252-09 Écran miroir ARGENT **39,90 €** I.T.C.



Tous les masques adultes FMF Vision utilisent les mêmes écrans et les mêmes tear-offs.

Tous les accessoires FMF Vision sont compatibles avec la première génération de masques de la marque 100%.

ACCESSOIRES

Écrans de remplacement FMF standards

Écran monocouche en polycarbonate anti-buée pour PowerBomb et PowerCore. Protections contre les UVA et UVB jusqu'à 400 nm



Miroir bleu

Adulte - F-51002-002-02 26,00 €
T.T.C.



Miroir rouge

Adulte - F-51002-003-02 26,00 €
T.T.C.



Fumé

Adulte - F-51002-003-02 12,00 €
T.T.C.
Enfant - F-51003-007-02



Miroir argent

Adulte - F-51002-008-02 26,00 €
T.T.C.



Miroir or

Adulte - F-51002-009-02 26,00 €
T.T.C.
Enfant - F-51003-009-02



Transparent

Adulte - F-51001-010-02 12,00 €
T.T.C.
Enfant - F-51003-010-02



Transparent bleu

Adulte - F-51001-002-02 12,00 €
T.T.C.



Transparent jaune

Adulte - F-51001-004-02 12,00 €
T.T.C.

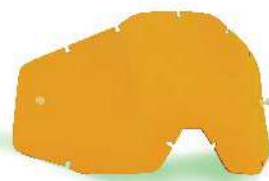

Transparent Persimmon

Adulte - F-51001-046-02 12,00 €
T.T.C.



Miroir or réaliste

Adulte - F-51002-074-02 26,00 €
T.T.C.



Double écran

Adulte - F-51005-010-02 19,00 €
T.T.C.

Tous les masques adultes FMF Vision utilisent les mêmes écrans et les mêmes tear-offs.

Les masques équipés d'un écran miroir sont vendus avec un écran transparent.

FILM SYSTEM

Système de film 100% largeur 45mm / Cartouche autonettoyante / Cordon coulissant lisse / Écran polycarbonate antibuée maintenu au cadre par 9 points de fixation / Compatible POWERBOMB et POWERCORE

Dans la boîte : mud-flap, 2 rouleaux de film et sac en microfibre

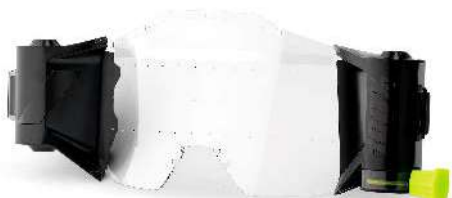

Adulte - F-51220-500-01

49,00 €
T.T.C.

Enfant - F-51221-500-01

Protège nez POWERBOMB

Protège-nez de remplacement pour les lunettes POWERBOMB pour adultes. Disponible en noir ou blanc. Non adaptable sur POWERCORE



Noir - F-51037-001-01



Blanc - F-51037-000-01

11,00 €
T.T.C.

TEAR OFF



Pack de 20 17,00 €
T.T.C.

Adulte - F-51011-010-02

Enfant - F-51012-010-02



Pack de 50 33,00 €
T.T.C.

Adulte - F-51011-013-02

Écran FILM SYSTEM

Adulte - F-51121-510-02

16,00 €
T.T.C.



Film 45mm 18,99 €
T.T.C.

6 rouleaux - F-51122-010-02



Cartouches 14,00 €
T.T.C.

La paire - F-51124-001-01



Laminés 2x7 16,00 €
T.T.C.

Adulte - F-51010-010-02



STRAP PINS 7,50 €
T.T.C.

Adulte - F-51013-001-02



Mud Flap x3

Adulte - F-51126-610-02

Enfant - F-51226-610-02

16,00 €
T.T.C.

LUNETTES DE SOLEIL



Solaires en collaboration avec 100%

En travaillant avec 100%, le leader de l'optique de précision, nous avons développé une ligne de lunettes influencée par notre passion pour la course et les athlètes qui nous ont inspirés à travers les générations.

THE DON

100% protection UV / Monture en polycarbonate léger et durable / Verres en polycarbonate incassables / Livré avec une pochette de nettoyage en microfibre



Verres miroir bleus

Noir mat fondu- F-61506-250-01

59,00 €
T.T.C.



Verres miroir rouges

Noir mat- F-61506-251-01

59,00 €
T.T.C.

FACTORY

100% protection UV / Monture en polycarbonate léger et durable / Verres en polycarbonate incassables / Livré avec une pochette de nettoyage en microfibre



Verres polarisés gris

Noir mat polarisé- F-61502-711-01

69,00 €
T.T.C.



Verres miroir argentés

Cristal mat- F-61502-252-01

59,00 €
T.T.C.

EMLER

100% protection UV / Monture en polycarbonate léger et durable / Verres en polycarbonate incassables / Livré avec une pochette de nettoyage en microfibre



Verres miroir argentés

Noir mat- F-61508-252-01

59,00 €
T.T.C.



Verres miroir bleus

Cristal mat- F-61508-250-01

59,00 €
T.T.C.



THROTTLE

100% protection UV / Monture en polycarbonate léger et durable / Verres en polycarbonate incassables / Livré avec une pochette de nettoyage en microfibre



Verres miroir bleus

Noir mat- F-61501-250-01

59,00 €
I.T.C.



Verres miroir argentés

Cristal mat- F-61501-252-01

59,00 €
I.T.C.



Verres miroir rouges

Bleu pétrole mat- F-61501-251-01

59,00 €
I.T.C.



GEARS

100% protection UV / Monture en polycarbonate léger et durable / Verres en polycarbonate incassables / Livré avec une pochette de nettoyage en microfibre



Verres miroir bleus

Bleu pétrole mat- F-61503-260-01

59,00 €
T.T.C.



Verres miroir bleus

Noir mat- F-61503-251-01

59,00 €
T.T.C.



Verres polarisés gris

Cristal mat- F-61503-711-01

69,00 €
T.T.C.



MASQUES



VISTA miroir 92,90 €
T.T.C.

3303 FL

CHOIX
ÉCRAN

STRAP
silicone

X2 MOUSSE
DOUBLE DENSITE

OTG



Bleu orange fluo - 3303FL18BOF

Écran miroir 3347



Noir blanc - 3303FL18NBL

Écran miroir 3348



Jaune fluo rouge - 3303FL18JFR

Écran miroir 3348



Turquoise noir - 3303FL18TUN

Écran miroir 3348



Rouge bleu - 3303FL18RB

Écran miroir 3346



Écran supplémentaire
Inclus dans la boîte

E3310

16,20 €
T.T.C.

Écran ransparent anti buée

VISTA 89,90 € T.T.C.

3303

CHOIX
ÉCRAN

STRAP
silicone

X2 MOUSSE
DOUBLE DENSITÉ

OTG



Bleu - 330318B

Écran ransparent anti buée 3310



Noir - 330318N

Écran ransparent anti buée 3310



Blanc - 330318BL

Écran ransparent anti buée 3310



Rouge - 330318R

Écran ransparent anti buée 3310



ATZAKI mirror two 49,90 € T.T.C.

3201 FL

CHOIX
ÉCRAN

STRAP
silicone

X2 MOUSSE
DOUBLE DENSITE

OTG



Blanc noir - 3201FLBLN

Écran miroir 3248

NOUVEAUTÉ



Jaune fluo noir - 3201FLJFN

Écran miroir 3248

NOUVEAUTÉ



Orange fluo noir - 3201FLOFN

Écran miroir 3246



Rouge blanc - 3201FLRBL

Écran miroir 3246

ATZAKI mirror 44,70 € T.T.C.



Noir - 3201FLN

Écran miroir 3252



Bleu - 3201FLB

Écran miroir 3247



Orange fluo - 3201FLOF

Écran miroir 3246



Blanc - 3201FLBL

Écran miroir 3246



Jaune fluo - 3201FLJF

Écran miroir 3248



Rouge fluo - 3201FLRF

Écran miroir 3247

ATZAKI base 2022 39,90 € T.T.C.

NOUVEAUTÉ

3201 TR - écran E3213

CHOIX
ÉCRAN

STRAP
silicone

X2 MOUSSE
DOUBLE DENSITÉ

OTG



Orange fluo - 3201TROF22



Argent - 3201TRA22



Vert - 3201TRV22



Bleu - 3201TRB22



Jaune fluo - 3201TRJF22



Rouge - 3201TRR22



Blanc - 3201TRBL22



Noir - 3201TRN22

ATZAKI base 39,90 € T.T.C.



Argent - 3201TRA



Orange - 3201TRO



Bleu - 3201TRB



Jaune - 3201TRJ



Rouge - 3201TRR



Blanc - 3201TRBL



Noir - 3201TRN



Vert fluo - 3201TRVF

ATZAKI ventilé 64,90 € T.T.C.

3201 DL - double écran anti-buée photosensible E3235



LE MUST ANTI-BUÉE



Noir - 3201DLN

NASWA 69,90 € T.T.C.

3301 DL - double écran anti-buée photosensible

Jusqu'à épuisement des stocks



Blanc - 3301DLBL



Noir - 3301DLN

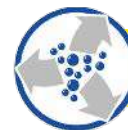

LE MUST ANTI-BUÉE

ATZAKI kid 65,80 € T.T.C.

3101 - écran miroir ou transparent



Orange fluo - 3101FLOF

Écran miroir 3146



Bleu - 3101FLB 65,80 € T.T.C.

Écran miroir 3147



Noir - 3101N 52,40 € T.T.C.

Écran 3111



Blanc - 3101FLBL 45,80 € T.T.C.

Écran 3111



VENOM mirror two 114,90 € T.T.C.

NOUVEAUTÉ

3200 FL

X2 MOUSSE
DOUBLE DENSITE

STRAP
silicone

OTG



Jaune Fluo Bleu - 3200FLJBE

Écran miroir 3248



Bleu clair blanc - 3200FLBCL

Écran miroir 3253



Noir blanc - 3200FLNBL

Écran miroir 3248



Rouge bleu - 3200FLRB

Écran miroir 3246



Rouge gris - 3200FLRG

Écran miroir 3247



Bleu orange fluo - 3200FLBOF

Écran miroir 3247

- Verres anti UV, anti-rayures
- NO FOG Progrip, meilleur anti-buée du marché
- Broches pour tear-offs
- Mousse double densité avec velours hydrofuge
- Strap avec silicone pour un bon maintien sur le casque
- Mousse prédécoupée pour les branches de lunettes



VENOM Light Sensitive 104,90 € T.T.C.

NOUVEAUTÉ

3200 FL - écran E3298

X2 MOUSSE
DOUBLE DENSITE

STRAP
Silicone

OTG



Carbone - 3200LSCA



Blanc orange - 3200LSBLO



Blanc noir- 3200LSNBL



Blanc bleu - 3200LSBLB



Blanc rouge - 3200LSBLR



VISION mirror two

56,70 €
T.T.C.

NOUVEAUTÉ

3300 FL

x2 MOUSSE
DOUBLE DENSITE

STRAP
silicone

OTG



Jaune fluo gris - 3300FLJG

Écran miroir 3347



Blanc rouge - 3300FLBLR

Écran miroir 3346



Noir blanc - 3300FLNBL

Écran miroir 3352

VISION base

51,90 €
T.T.C.

NOUVEAUTÉ

3300 - écran 3310

x2 MOUSSE
DOUBLE DENSITE

STRAP
silicone

OTG



Blanc rouge - 3300TBRLR



Noir blanc - 3300TRNBL



Jaune fluo gris - 3300TRJFG



ATZAKI roll off 149,90 € T.T.C.

3201 RO - écran E3215

X2 MOUSSE
DOUBLE DENSITE

STRAP
silicone



Orange - 3201ROO



Blanc - 3201ROBL



Bleu - 3201ROB



Noir - 3201RON



Rouge - 3201ROR

+25% **XLROLLOFF**
SYSTEM

Hauteur 40 mm



VENOM roll off XL

167,90 €
T.T.C.

NOUVEAUTÉ

3200 RO - écran E3215

X2 MOUSSE
DOUBLE DENSITE

STRAP
Silicone

OTG



Carbone - 3200ROCA



Bleu orange fluo - 3200ROBOF



Jaune fluo bleu - 3200ROJBE



Rouge gris - 3200RORG



Orange - 3200ROO



Bleu - 3200ROB



Noir - 3200RON



RIOT roll off XL

159,90 €
T.T.C.

NOUVEAUTÉ

3450 RO- écran E3215

MOUSSE
DOUBLE DENSITÉ

STRAP
silicone

OTG



Orange fluo bleu - 3450RO0FB



Bleu clair blanc - 3450ROBCBL



Blanc noir - 3450ROBLN



Jaune fluo bleu marine - 3450ROJFBM



Bleu rouge - 3450ROBLR



VISTA roll off 152,90 € T.T.C.

3303 RO - écran E3315



Bleu - 3303R018B



Noir - 3303R018N



Rouge - 3303R018R



Blanc - 3303R018BL



Accessoires roll off XL 40 mm

Pour modèles : Atzaki, Naswa, Venom, Riot et Menace.

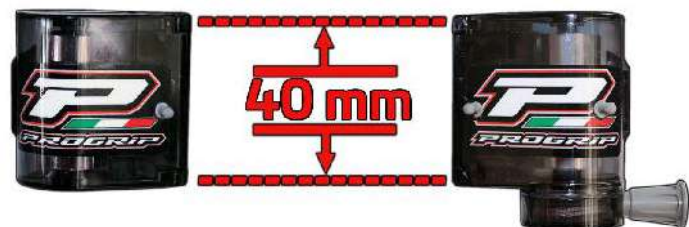

Roll off **XL 40mm** - E3268 63,40 €
I.T.C.



Capot - E3263 11,30 €
I.T.C.



Film x12 - E3269 58,10 €
I.T.C.

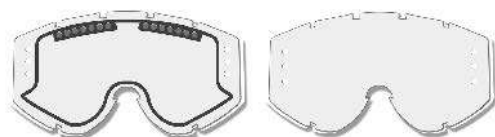

Écran double anti buée 3265 Écran anti buée 3215



Mud flap - E3267 11,15 €
I.T.C.



Strap - E3266 13,70 €
I.T.C.



Anti sueur - E3264 11,20 €
I.T.C.

Double écran anti buée - E3265 26,20 €
I.T.C.

Écran anti buée - E3215 20,40 €
I.T.C.

Accessoires roll off XL 50 mm

Pour modèles : Vista et Vision.

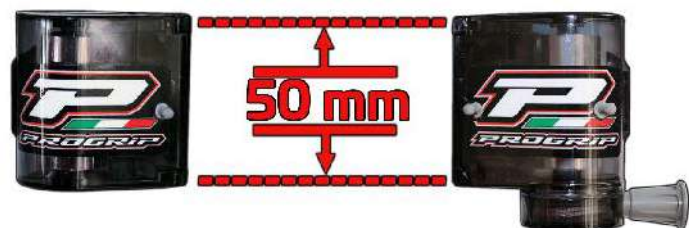

Roll off **XXL 50mm** - E3368 67,30 €
I.T.C.



Capot - E3263 11,30 €
I.T.C.



Film x8 - E3369 40,90 €
I.T.C.



Écran anti buée 3215

Écran anti buée - E3315 21,60 €
I.T.C.



Mud flap - E3367 12,10 €
I.T.C.

Green system

E3291

24,90 €
T.T.C.

Tear off universel et écologique !

NOUVEAUTÉ

- Système breveté
- Éco-responsable
- Câble avec embouts et clip de fixation
- Adaptable sur tous les masques (sauf Oakley)

Tear off

Atzaki / Naswa / Venom / Riot / Menace



Tear off x10 - E3270 12,90 €
T.T.C.

Tear off x25 - E3271 24,90 €
T.T.C.

Tear off laminés x7
+1 mud flap - E3276 18,10 €
T.T.C.

Vista / Vision



Tear off x10 - E3370 13,80 €
T.T.C.

Tear off x25 - E3371 29,85 €
T.T.C.



Écrans

Pour modèles : Atzaki, Naswa, Venom, Riot et Menace.



Transparent anti buée

E3210 15,30 € I.T.C.



Transparent bleu ciel anti buée

E3211 15,70 € I.T.C.



Anti buée double face

E3212 15,20 € I.T.C.



Anti rayure double face

E3213 15,20 € I.T.C.



Spécial Roll off anti buée

E3215 20,40 € I.T.C.



Fumé anti buée

E3220 15,80 € I.T.C.



Jaune anti buée

E3221 15,80 € I.T.C.



Orange anti buée

E3222 16,60 € I.T.C.



Light sensitive anti buée double face

E3235 26,70 € I.T.C.



Polarisé anti buée

E3244 56,50 € I.T.C.



Bleu miroir multicouche anti buée

E3246 38,90 € I.T.C.



Jaune miroir multicouche anti buée

E3247 38,90 € I.T.C.



Rouge miroir multicouche anti buée

E3248 38,90 € I.T.C.



Orange miroir multicouche anti buée

E3249 38,90 € I.T.C.



Vert miroir multicouche anti buée

E3251 38,90 € I.T.C.



Argent miroir multicouche anti buée

E3252 38,90 € I.T.C.



Bleu ciel miroir multicouche anti buée

E3253 38,90 € I.T.C.



Light sensitive rouge anti buée double face

E3255 26,00 € I.T.C.



Jaune anti buée double face

E3256 26,00 € I.T.C.



Orange anti buée double face

E3257 26,00 € I.T.C.



Spécial Roll off double anti buée

E3265 26,20 € I.T.C.



Miroir sphérique anti buée

E3295 42,20 € I.T.C.



Miroir arc en ciel anti buée

E3297 43,80 € I.T.C.

Écrans

Pour modèles : Vista et Vision.



Transparent anti buée

E3310 16,20 €
I.T.C.



Bleu miroir multicouche
anti buée

E3346 39,30 €
I.T.C.



Jaune miroir multicouche
anti buée

E3347 39,30 €
I.T.C.



Rouge miroir multicouche
anti buée

E3348 39,30 €
I.T.C.



Spécial Roll off anti buée

E3315 21,60 €
I.T.C.

Écran kids



Transparent anti buée

E3111 15,40 €
I.T.C.

Stéphane WATEL
VITAMINE H LILLE

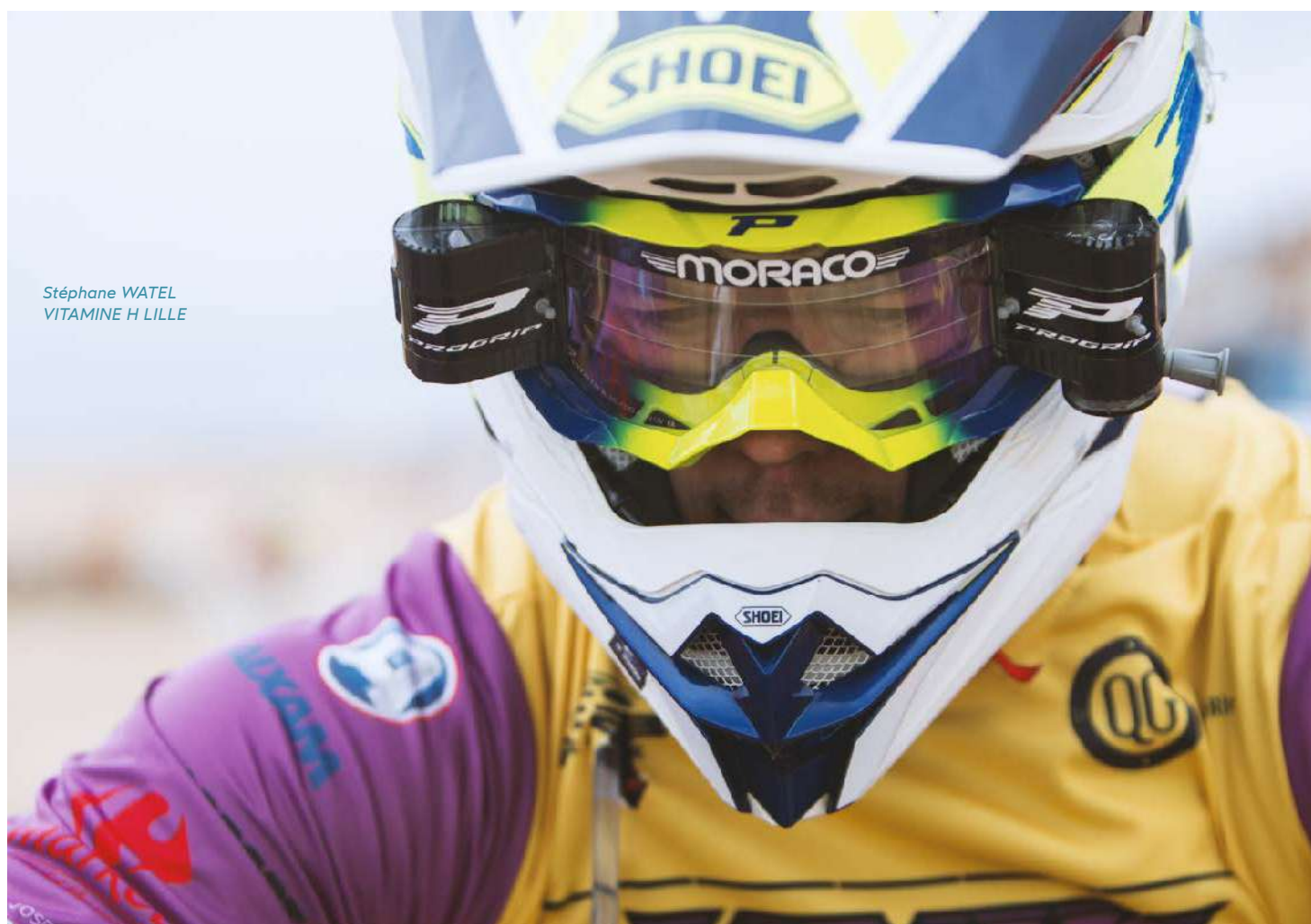

CASQUES



3180 édition 2022

NOUVEAUTÉ

179,90 €
T.T.C.

Design et sécurité

- Coque ABS hautement résistante
- Design signé BARGY DESIGN.
- Doublure intérieure en tissu absorbant, traitement antibactérien et hypoallergénique.
- Ventilation optimale avant arrière évitant les zone de turbulence et de pression.
- Le système d'enlèvement d'urgence des joues permet un retrait du casque facilité en cas d'accident en tirant sur les languettes orange intégrées, minimisant le risque de blessures supplémentaires.



Bleu Jaune fluo

S 3180SBJFL22
M 3180MBJFL22
L 3180LBJFL22
XL 3180XLBJFL22
Poids : 1 295 g

Rouge Blanc

S 3180SRBL22
M 3180MRBL22
L 3180LRBL22
XL 3180XLRBL22
Poids : 1 295 g



Bleu pétrole

S 3180SBP22
M 3180MBP22
L 3180LBP22
XL 3180XLP22
Poids : 1 295 g



Noir mat

S 3180SNM22
M 3180MNM22
L 3180LNM22
XL 3180XLM22
Poids : 1 295 g



Vert Fuschsia

S 3180SVF22
M 3180MVF22
L 3180LVF22
XL 3180XLVF22
Poids : 1 295 g

3009 kid



NOUVEAUTÉ

179,90 €
I.T.C.

Orange Bleu clair

S	3009S0FLBC22
M	3009M0FLBC22
L	3009L0FLBC22



Vert Bleu clair

S	3009SVBC22
M	3009MVBC22
L	3009LVBC22



Design et sécurité

- Coque ABS hautement résistante
- Doublure intérieure en tissu absorbant, traitement antibactérien et hypoallergénique.
- Ventilation optimale avant arrière évitant les zone de turbulence et de pression.
- Poids : 1 195 g





INTERCOMS



50 S

NOUVEAUTÉ

SOUND BY
harman/kardon®

Commandes par molette, intercom déclipable du casque

Un nouveau sommet

Le nouveau système SENA 50S avec Mesh 2.0 offre des avancées significatives dans la communication à moto. Réseau de communication exceptionnel et haut-parleurs haute définition, le 50S connecte les motards tout au long de leur voyage.

*Commandes par molette
Intercom déclipable du casque*



50 S solo* - 50S02

369,00 €
I.T.C.

50 S duo* - 50S02D

649,00 €
I.T.C.

Accessoires**	Référence	T.T.C.
Haut-parleurs	50SA0101	45,95 €
Haut-parleurs HD	SCA0325	45,95 €
Ensemble de pince, micro et écouteurs pour 50S	50SA0201	109,00 €



Haut-parleurs HD ultra fins de forme biseautée

Caractéristiques série 50



Mesh 2.0
jusqu'à 24 personnes



Bluetooth® 5



Haut-parleurs HD



Communication
multicanal



Mesh intercom
illimité jusqu'à 8 km



Accès à l'assistant
numérique



Advanced Noise
Control™ (1)



Mise à jour du
micrologiciel
automatique



Commande vocale
multilingue

Inclus dans la boîte :



2 Micros



Câble de synchronisation WiFi



Câble de charge USB-C



Câble audio 2,5 mm vers 3,5 mm

50 R

NOUVEAUTÉ

SOUND BY
harman/kardon®

Commandes par boutons, intercom fixé au casque

Une avancée technologique

Avec le Mesh 2.0, le 50R associe la technologie la plus avancée à l'élégance et la robustesse. Testé et approuvé par les participants du GS Trophy 2020 en Nouvelle Zélande. Apparence profilée, durabilité et technologie supérieures, le 50R établit une nouvelle manière de communiquer.

50 R solo* - 50R02

369,00 €
T.T.C.

50 R duo* - 50R02D

649,00 €
T.T.C.Commandes par boutons
Intercom fixé au casque

Accessoires**	Référence	T.T.C.
Haut-parleurs	50RA0101	45,95 €
Kit fixation, micros et écouteurs	50RA0201	64,00 €

5 S

NOUVEAUTÉ

Installation et utilisation faciles

Restez connecté et profitez de la route avec le SENA 5S

Facile à utiliser et accessible avec haut-parleurs HD, intercom 2 voies HD, écran LCD intégré et partage de musique. La molette offre une interface utilisateur intuitive qui est beaucoup plus facile à contrôler pendant la conduite, ce qui signifie que vous roulez plus en sécurité.

5 S solo* - 5S02
5 S duo* - 5S02D

169,00 €
I.T.C.
319,00 €
I.T.C.

Accessoires**	Référence	T.T.C.
Haut-parleurs fins	SMH5A0307	30,95 €
Haut-parleurs	5SA0101	45,95 €
Haut-parleurs HD	SCA0326	45,95 €
Ensemble de pince, micro et écouteurs pour 5S	5SA0201	59,95 €
Mousses pour micro (5 pièces)	SCA0109	7,95 €



(HD)

Intercom HD



Bluetooth® 5



Haut-parleurs HD



Intercom bidirectionnel



Intercom 700 m



Audio Multitasking™



écran LCD



Commande vocale



Application smartphone

30 K

Le 30 K s'occupe de tout pour vous

Fiable, robuste, technologie Mesh™

Connecter en un clic les utilisateurs de 30K dans un rayon de 1,6 km, grâce au réseau maillé adaptatif Mesh. Le 30K recherche des connexions intercom perdues et les récupère dès qu'elles sont dans le rayon de portée ; sans affecter le reste du groupe.



Station d'accueil wifi



30 K solo* - 30K02

299,00 €
T.T.C.

30 K duo* - 30K-02D

519,00 €
T.T.C.

Accessoires**	Référence	T.T.C.
Station d'accueil wifi	SCDS01	69,95 €
Haut-parleurs fins	SCA0323	41,95 €
Haut-parleurs HD	SCA0325	45,95 €
Support de fixation complet, Haut-parleurs et micro	SCA0315	95,95 €
Support de fixation complet, Haut-parleurs fins et micro	SCA0318	95,95 €



Mesh 2.0



Bluetooth® 4.1



Audio Multitasking™(2)



Intercom multidirectionnel



Intercom 2 km



Commande à distance



Group Intercom™



Commande vocale



Advanced Noise Control™(1)



* Eco-participation 0,08 € H.T. / ** Eco-participation 0,02 € H.T. / (1) Permet d'atténuer le bruit de fond lors d'une conversation. Fonction désactivable.

(2) L'Audio Multitasking permet une conversation tout en écoutant de la musique, la radio ou les instructions du GPS.

SF Series

Solution optimale, design élégant.

À deux ou en petit groupe, partez tranquilles !

La série SF est dotée de fonctionnalités optimales. Le SF1 assure une connexion Bluetooth®. Outre les caractéristiques du SF1, les modèles SF4 et SF2 offrent les fonctions Intercom, partage de musique, Audio Overlay, radio FM. Fixation sans pince pour le SFR.

SF1



Intercom pilote/passager
Portée 100 m

SF1 solo* - SF101
SF1 duo* - SF101D

139,95 € I.T.C.
249,95 € I.T.C.



SF2



Intercom 2 voies
Portée 800 m
Radio FM

SF2 solo* - SF203
SF2 duo* - SF203D

159,95 € I.T.C.
298,95 € I.T.C.



HD ENJOY MUSIC ON A NEW LEVEL.
with **POWERFUL BASS** and **CLEAR SOUND**
SPEAKERS

Haut-parleurs haute définition

Désormais, tous les intercoms de la gamme SF sont vendus avec des haut-parleurs ultra fins de haute définition.



Haut-parleurs HD
HD Voice



Bluetooth® 4.1



Radio FM
SF2 / SF4 / SFR



Fixation rapide

SF4



Intercom 4 voies
Portée 1 200 m
Radio FM



SF4 solo* - SF402
SF4 duo* - SF402D

219,95 €
T.T.C.
389,95 €
T.T.C.

SFR



Intercom 4 voies
Portée 1 200 m
Radio FM



SFR* - SFR01

219,95 €
T.T.C.

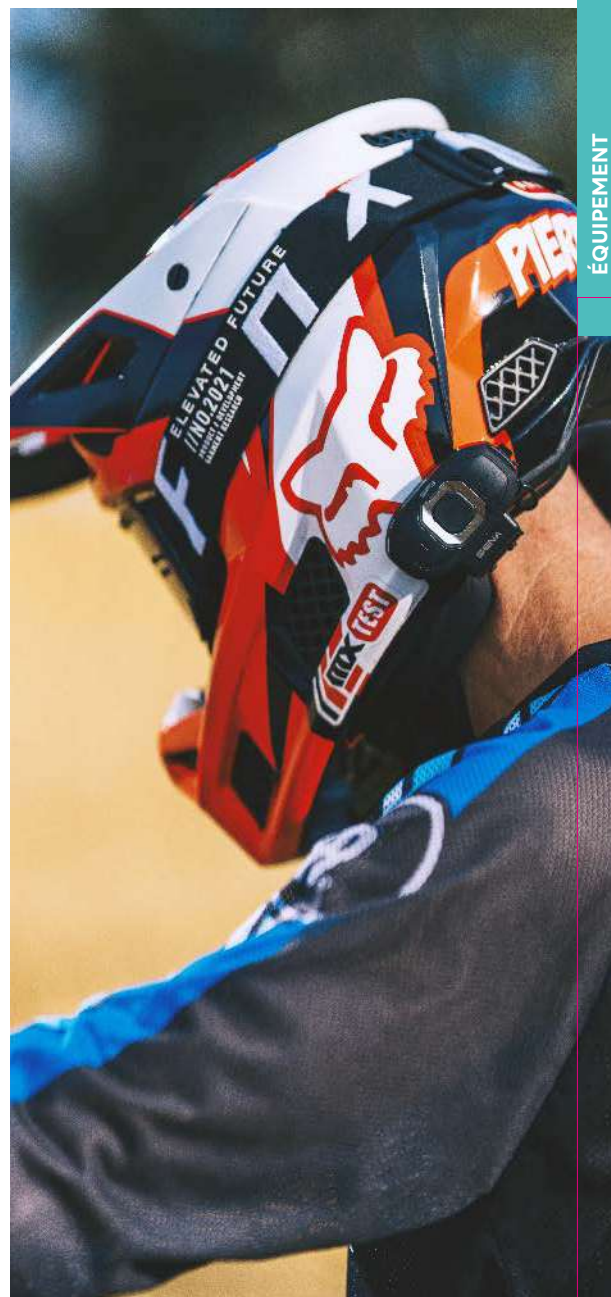

SF 1/2/4



SFR

Accessoires SF SERIES**	Référence	T.T.C.
Kit fixation, micros et écouteurs pour SFR	SFRA1000	39,95 €
Ensemble de pince, micro et écouteurs pour SF1, SF2, SF4.	SFA0202	64,95 €
Haut-parleurs HD	SFA0302	26,95 €
Ensemble de pince, micro et haut-parleurs HD pour SF1, SF2, SF4.	SFA0203	64,95 €



SF1 : 100 m
SF2 : 800 m
SF4/SFR : 1,2 km



SF1 : pilote/passager
SF2 : 2 voies
SF4 / SFR : 4 voies



Commande vocale et à distance



Partage audio



Audio Overlay⁽¹⁾



Charge rapide



Application smartphone

* Eco-participation 0,08 € H.T. / ** Eco-participation 0,02 € H.T. / (1) sur appareils Android, si la fonction est activée, les instructions GPS n'interrompent pas votre écoute ou une communication.

20S evo

Expérience repensée

Le design élancé de la nouvelle antenne améliore la stabilité et la portée de l'intercom de groupe. Les dernières avancées matérielles renforcent ses performances et actualisent le système.

20S evo solo* - 20SEV011
20S evo duo* - 20SEV011D

269,00 €
T.T.C.
489,00 €
T.T.C.



Accessoires**	Référence	T.T.C.
Ensemble de pince, micros et écouteurs pour 20S, 30K, 50S	SCA0315	95,95 €
Ensemble de pince, micros et écouteurs fins pour 20S, 30K, 50S	SCA0318	95,95 €
Haut-parleurs fins	SCA0323	41,95 €
Haut-parleurs HD type A	SCA0325	45,95 €
Câble audio 2,5 à 3,5 m	SCA0129	7,95 €



10S

Fonctions familières, performances améliorées

Écoutez de la musique et maintenez le contact avec 3 compagnons de route grâce à la qualité audio HD, sur une distance pouvant atteindre 1,6 km.

10S solo* - 10S02
10S duo* - 10S02D

239,00 €
T.T.C.
439,00 €
T.T.C.



Accessoires**	Référence	T.T.C.
Ensemble de pince, micros et écouteurs pour 10S	10SA0301	83,95 €
Câble audio 2,5 à 3,5 m	SCA0108	6,95 €



SMH5 Series

SMH5

SMH5 solo* - SMH5UNIV
SMH5 duo* - SMH5DUNIV

99,00 € I.T.C.
189,00 € I.T.C.



Partagez l'expérience

La série SMH5 offre une fonctionnalité intercom 2 voies (MultiCom 4 voies) permettant de partager conversations et musique. Grâce à son attache rapide, le SMH5 MultiCom permet de transférer facilement l'unité d'un casque à un autre. Solution idéale pour la formation à la conduite ou la location de motos.

SMH5 FM

SMH5 FM solo* - SMH5FMUNIV
SMH5 FM duo* - SMH5DFMUNIV

129,00 € I.T.C.
239,00 € I.T.C.



Multicom

SMH5 MultiCom* - SMH5MC01

119,00 € I.T.C.







Le MultiCom

Une oreillette

Fixation rapide

Best-seller de la formation

Accessoires**	Référence	T.T.C.
HP fins pour SMH5	SMH5A0307	30,95 €
Ensemble de pince, micros et écouteurs pour SMH5 et FM	SMH5A0313	51,95 €
Ensemble de pince, micros et écouteurs pour MultiCom	SMH5MCA0202	47,95 €

 Commande de lecture	 SMH5 : 400 m FM / MultiCom : 700m	 Commande vocale	 Bidirectionnel (SMH5 et FM)	 Intercom 4 voies (MultiCom)
 Bluetooth® 3	 Universal Intercom™	 Advanced Noise Control™ (1)	 Fixation rapide	



3S PLUS NOUVEAUTÉ

Intercom à intégrer au casque

Solution simple pour communication haut de gamme avec un casque moto. Le traitement du signal Bluetooth® 4.1 permet au 3S+ de fournir des performances audio exceptionnelles.

Accessoires**	Référence	T.T.C.
Câble d'alimentation et de données micro USB	SCA0100	4,95 €
Mousses pour micro (5 pièces)	SCA0109	7,95 €

3S+ BOOM* - 3SPLUSB	109,00 € T.T.C.
3S+ UNIVERSAL* - 3SPLUSWB	109,00 € T.T.C.



3S PLUS BOOM
Casque jet



3S PLUS UNIVERSAL
Casque intégral et modulable



Musique stéréo
Bluetooth®



Bluetooth® 4.1
et USB C



Commande
de lecture



Booster audio



HD Intercom 2 voies
portée 400 m



Smart Intercom
Pairing



Utilisation facile à
2 boutons



Commande vocale
multi-langue



Intercom HD



SENA Utility App



Caméras

Une combinaison de pointe

10C evo

NOUVEAUTÉ



10C evo* - 10CEVO01

449,00 €
I.T.C.

10C pro



10C pro* - 10CPR001

399,00 €
I.T.C.

2K ou 4K, à vous de choisir, mais la qualité est sans compromis. Système de communication et caméra WiFi permettant de visualiser et de télécharger des vidéos sur son smartphone instantanément.



ÉQUIPEMENT
DU PILOTE

Accessoires**	Référence	T.T.C.
Câble adaptateur en Y pour écouteurs	10CA0101	15,95 €
Ensemble de pince, micros et écouteurs pour 10C EVO	10CEVOA0311	47,95 €
Ensemble de pince, micros et écouteurs pour 10C PRO	10CA0311	47,95 €
Câble d'alimentation et de données micro USB droit	SCA0309	4,95 €
Bonnettes micros x5	10CA0109	7,95 €
Haut-parleurs HD type B	SCA0326	45,95 €



Bluetooth® 4.1



HD Voice



Smart audio mix



QHD / Full HD (PRO)
UHD 4K (EVO)



Compatible télécommande



Advanced Noise Control™(1)



Conception tout-en-un affinée



WiFi



Intercom 4 voies



Intercom jusqu'à 1,6 km

Télécommandes

La simplicité des commandes, tranquillité d'esprit.

Sur le guidon ou au poignet, le choix vous appartient.

Les commandes à distance vous permettent de contrôler facilement et en toute sécurité votre système de communication SENA, afin de vous concentrer sur l'essentiel, la route.



Étanche



Bluetooth® 4.1

RC 4



RC 4* - SC4B01

99,00 €
T.T.C.

RC 3



RC 3* - SC3B01

54,95 €
T.T.C.

Bracelet



Poignet* - SCWR01

99,00 €
T.T.C.

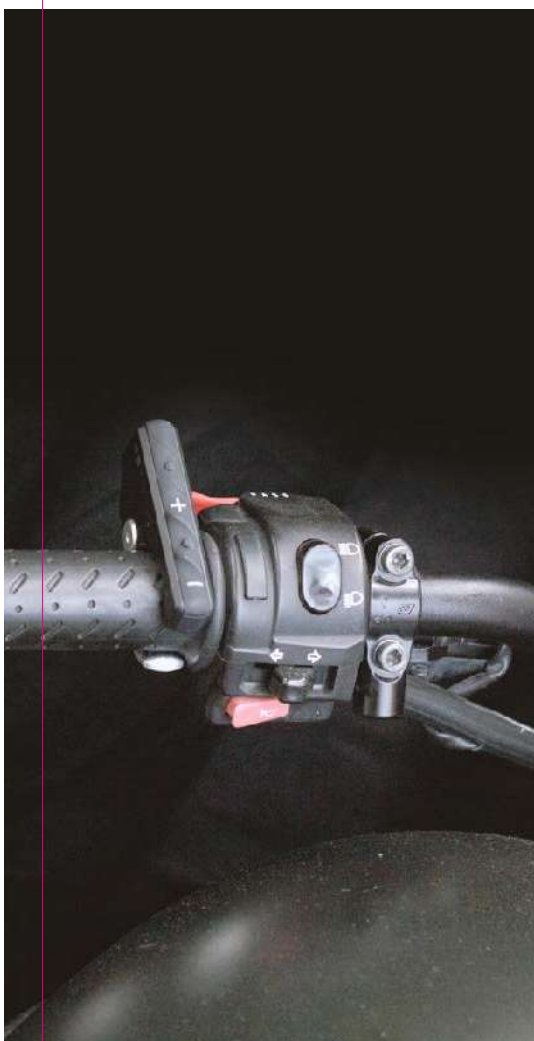

+MESH

NOUVEAUTÉ*Un maillage parfait*Fixation au guidon
ou adhésive**Adaptateur Bluetooth® - B2M01****119,00 €**
T.T.C.

+MESH, adaptateur Bluetooth® pour intercoms MESH

Avec +Mesh, tout dispositif SENA peut profiter des avantages de la technologie Mesh. L'adaptateur permet une communication avec tout autre appareil disposant du système Mesh, remplaçant ainsi la connexion Bluetooth®.



Mesh 2.0



Bluetooth® 4.1



Intercom 800 m



Tufftalk M

NOUVEAUTÉ

Solution de protection auditive et de communication pour les environnements bruyants



Communication mains libres grâce à la technologie full-duplex

Le casque Tufftalk M offre une protection auditive tout en vous permettant de communiquer sur des chantiers bruyants. Le casque se décline en deux styles, chacun avec son indice de réduction du bruit respectif: casque antibruit (26 dB) et casque intégré (24 dB). Il est conçu de façon à répondre à un confort et une sécurité optimale, avec un système intercom mains libres et une disposition à trois boutons facilitant le contrôle.

Accessoires**	Référence	T.T.C.
Micro	TUFFTALKA0205	13,95 €
Kit mousses et bonnettes	TUFFTALKA0204	21,95 €
Câble micro USB	SCA0100	4,96 €

TUFFTALK M* - TUFFTALKM01
529,00 €
T.T.C.

Mesh 2.0



Bluetooth® 4.1



Atténuation 26 db



Communication full duplex



Intercom 1,1 km



Communication multi-groupe 9 canaux

 Advanced Noise Control™⁽¹⁾

Commande vocale



Application smartphone



Radio FM

Comparatifs produits

Intercoms

	Bluetooth®	SENA App	Compatibilité télécommande	Temps de conversation	Nb max d'intercom, distance	Commande vocale	Audio Multitasking™
50S / 50R	5	50 Utility	○	Bluetooth® : 13 h Mesh Intercom™ : 8 h	Mesh Intercom™ : illimité 2 km Bluetooth® : jusqu'à 4, 2 km	○	○
5S	5	SENA Utility	○	7h	Jusqu'à 2, 700 m	○	○
SF4 / SFR	4.1	SF Utility	○	13h	Jusqu'à 4, 1,2 km	-	Audio Overlay
SF2	4.1	SF Utility	○	13h	Jusqu'à 2, 800 m	-	Audio Overlay
SF1	4.1	SF Utility	○	13h	Jusqu'à 2, 100 m	-	Audio Overlay
30K	4.1	30K Utility	○	Bluetooth® : 13 h Mesh Intercom™ : 8 h	Mesh Intercom™ ouvert : illimité 1,6 km Mesh Intercom™ fermé : jusqu'à 16, 2 km Bluetooth® : jusqu'à 4, 2 km	○	○
20S EVO	4.1	SENA Utility	○	13h	Jusqu'à 8, 2 km	○	○
10S	4.1	SENA Utility	○	12h	Jusqu'à 4, 1,6 km	-	-
SMH5	3	-	-	7h	Jusqu'à 2, 400 m	-	-
SMH5 FM	3	-	-	7h	Jusqu'à 2, 700 m	-	-
SMH5 MultiCom	3	-	-	7h	Jusqu'à 4, 700 m	-	-
3S PLUS	4.1	SENA Utility	-	8	400 m	-	-

Caméras

	Bluetooth®	SENA App	Compatibilité télécommande	Temps de conversation	Nb max d'intercom, distance	Commande vocale	Audio Multitasking™
10C PRO / 10C EVO	4.1	SENA Camera	○	17h	Jusqu'à 4, 1,6 km	-	○

	VIDÉO			PHOTO			
	Résolution	Champ de vision	Temps d'enregistrement	Résolution	Prise de vue unique	Rafale	Accélééré
10C PRO	1440p/30 ips 1080p/60,30 ips	135°	2h	3,7 MP (16:9)	○	5 clichés	1/10 s
10C EVO	2160p/30 ips 1440p/30 ips 1080p/60 ips 1080p/30 ips	125°	1h30min	4 K	-	8 ips	-

Caractéristiques communes aux 10C pro et 10C evo :

Enregistrement en boucle - Enregistrement haut-parleurs - Horodatage - Bluetooth® 4.1 - Compatibles télécommandes - Bluetooth® audio recording - SENA camera app

Télécommandes

	Bluetooth®	Type de bouton	Type de montage	Temps de fonctionnement	Type de batterie	Temps de charge	Utilisation pendant le chargement
RC4	4,1	4 boutons	Guidon	5 mois	Pile bouton (CR2016)	-	-
RC3	4,1	3 boutons	Attache à clipser / Surface courbe adhésive	5 mois	Pile bouton (CR2016)	-	-
Poignet	4,1	1 joystick + 2 boutons	Bracelet / Surface plane adhésive	3 mois	Batterie intégrée rechargeable	2 heures	○



Outsider

De nouveaux produits à chaque saison, bien positionnés, adaptés à l'utilisation des pilotes et sans cesse en amélioration.

En association avec le plus grand nom du kit déco sur cette catégorie: KUTVEK.



design by Kutvek



In dirt we trust...

Notre slogan nous accompagne au quotidien ! Nous sommes de vrais passionnés de tout terrain. Notre force : être à l'écoute de nos consommateurs les plus exigeants afin de produire la plus haute qualité et les meilleurs produits tout-terrain au monde !

ÉQUIPEMENT DE LA MOTO

KITS DÉCO ROUND & SPIKE /
HOUSSES DE SELLES /
PLASTIQUES /
PROTÈGE MAINS /



KIT DÉCO	126
APPLICATIONS KIT DÉCO	178
HOUSSE DE SELLE	180
NUMÉROS	181
PLASTIQUES HONDA	182
PLASTIQUES YAMAHA	188
PLASTIQUES KAWASAKI	196
PLASTIQUES SUZUKI	200
PLASTIQUES KTM	204
PLASTIQUES HUSABERG	212
PLASTIQUES HUSQVARNA	214
PLASTIQUES GAS GAS	220
PLASTIQUES BETA	222
PLASTIQUES UNIVERSELS	224
PROTÈGE MAINS	230
PROTECTIONS	246

Pour chaque moto, nous vous proposons deux gammes de kit déco : ROUND et SPIKE.



YZF 450



WRF 450

KIT DÉCO

YAMAHA 4 TEMPS

ROUND

 99,90 €
I.T.C.

Huit éléments à coller.

Le kit ne comprend pas les fonds de plaque avant et latéraux

Complétez votre personnalisation ou remise à neuf avec une housse de selle page 180



design by *Kutvey*

Applications ROUND et SPIKE p. 178-179



YZ 125



YZ 85

KIT DÉCO

YAMAHA 2 TEMPS

ROUND

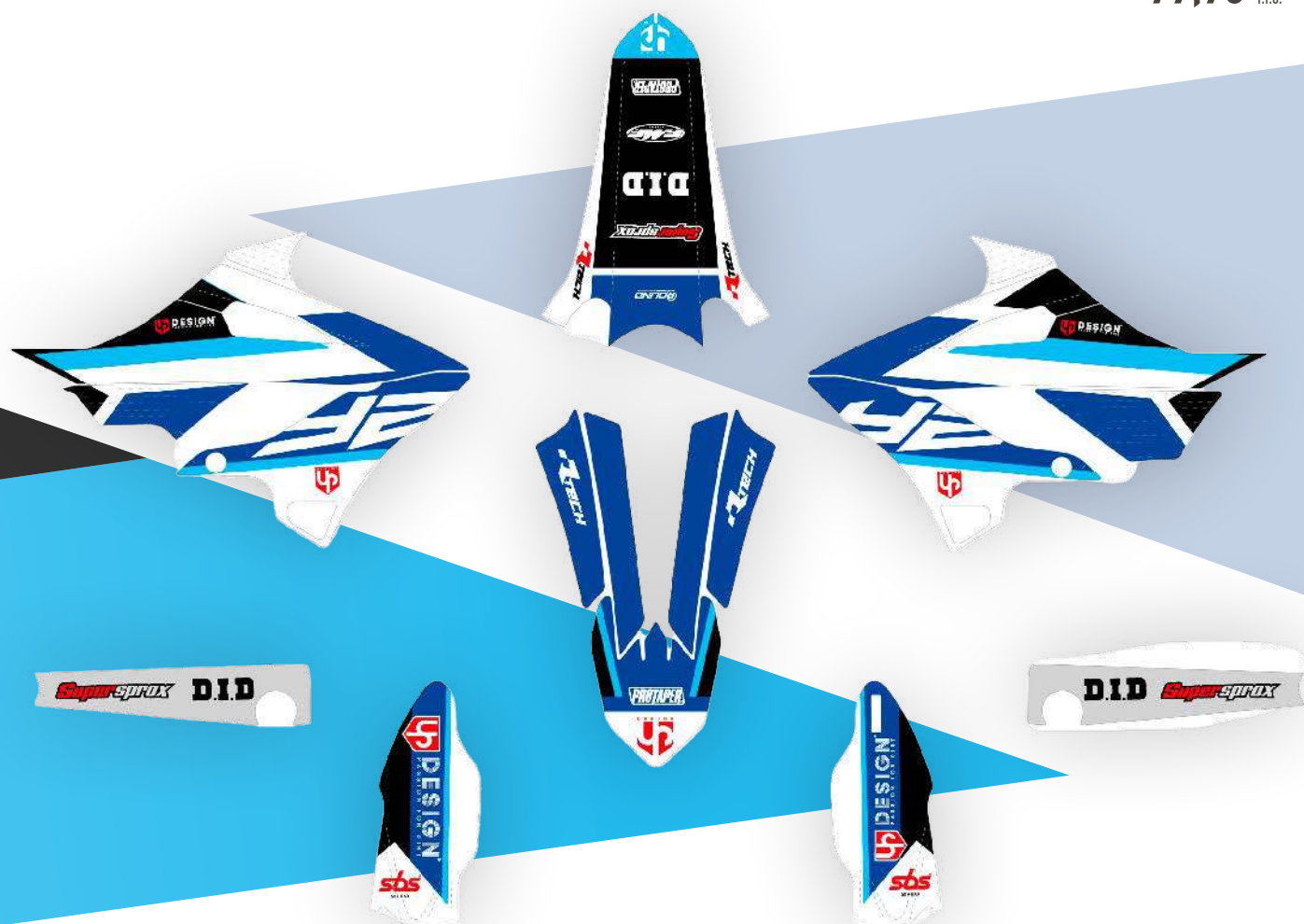
 99,90 €
I.T.C.

Huit éléments à coller.

Le kit ne comprend pas les fonds de plaque avant et latéraux

**Complétez votre personnalisation
ou remise à neuf avec une housse
de selle page 180**



design by Kutvey

Applications ROUND et SPIKE p. 178-179



PW 80



PW 50

KIT DÉCO YAMAHA PW

ROUND

PW 50 33,90 € I.T.C.

PW 80 66,90 € I.T.C.



design by *Kutvey*

Applications ROUND et SPIKE p. 178-179



YZF 450

Applications ROUND et SPIKE p. 178-179

Complétez votre
personnalisation ou
remise à neuf avec
une housse de selle
p. 180



KIT DÉCO YAMAHA 4 TEMPS



WRF 450

SPiKe

S E R I E

99,90 €
T.T.C.
design by Kutvey

Huit éléments à coller.

Le kit ne comprend pas les fonds de plaque
avant et latéraux



YZ 85

Applications ROUND et SPIKE p. 178-179

Complétez votre
personnalisation ou
remise à neuf avec
une housse de selle
p. 180



KIT DÉCO YAMAHA 2 TEMPS



YZ 125

SPiKe

S E R I E

99,90 €
T.T.C.
design by Kutvey

Huit éléments à coller.

Le kit ne comprend pas les fonds de plaque
avant et latéraux



Applications ROUND et SPIKE p. 178-179



PW 50

KIT DÉCO YAMAHA PW

PW 50 33,90 €
T.T.C.

PW 80 66,90 €
T.T.C.



PW 80

SPiKe
SERIE

design by Kutvey



SX-F 250



EXCF 450

KIT DÉCO KTM

SX/SXF ET EXC/EXCF

ROUND

99,90 € I.T.C.



Huit éléments à coller.

Le kit ne comprend pas les fonds de plaque avant et latéraux

**Complétez votre personnalisation
ou remise à neuf avec une housse
de selle page 180**



design by *Kutvey*

Applications ROUND et SPIKE p. 178-179



SX 85



SX 65

KIT DÉCO KTM

SX 65 ET SX 85

99,90 €
I.T.C.

Neuf éléments à coller.

Le kit ne comprend pas les fonds de plaque avant et latéraux pour le SX 85.

Complétez votre personnalisation ou remise à neuf avec une housse de selle page 180



design by Kutvey

Applications ROUND et SPIKE p. 178-179



Applications ROUND et SPIKE p. 178-179

Complétez votre
personnalisation ou
remise à neuf avec
une housse de selle
p. 180



KIT DÉCO KTM SX/SXF ET EXC/EXCF



SXF 250/450

SPiKe

S E R I E

99,90 €
T.T.C.
design by Kutvey

Huit éléments à coller.

Le kit ne comprend pas les fonds de plaque
avant et latéraux



SX 65

Applications ROUND et SPIKE p. 178-179

Complétez votre
personnalisation ou
remise à neuf avec
une housse de selle
p. 180



KIT DÉCO KTM SX 65 ET SX 85



SX 85

spike

S E R I E

99,90 €
T.T.C.
design by Kutvey

Huit éléments à coller.

Le kit ne comprend pas les fonds de plaque
avant et latéraux



FC 450



FE 450

KIT DÉCO HUSQVARNA

FC / FE



99,90 € I.T.C.



Huit éléments à coller.

Le kit ne comprend pas les fonds de plaque avant et latéraux

Complétez votre personnalisation ou remise à neuf avec une housse de selle page 180



design by *Kutvey*

Applications ROUND et SPIKE p. 178-179



KIT DÉCO HUSQVARNA TC 65

ROUND

99,90 €
I.T.C.

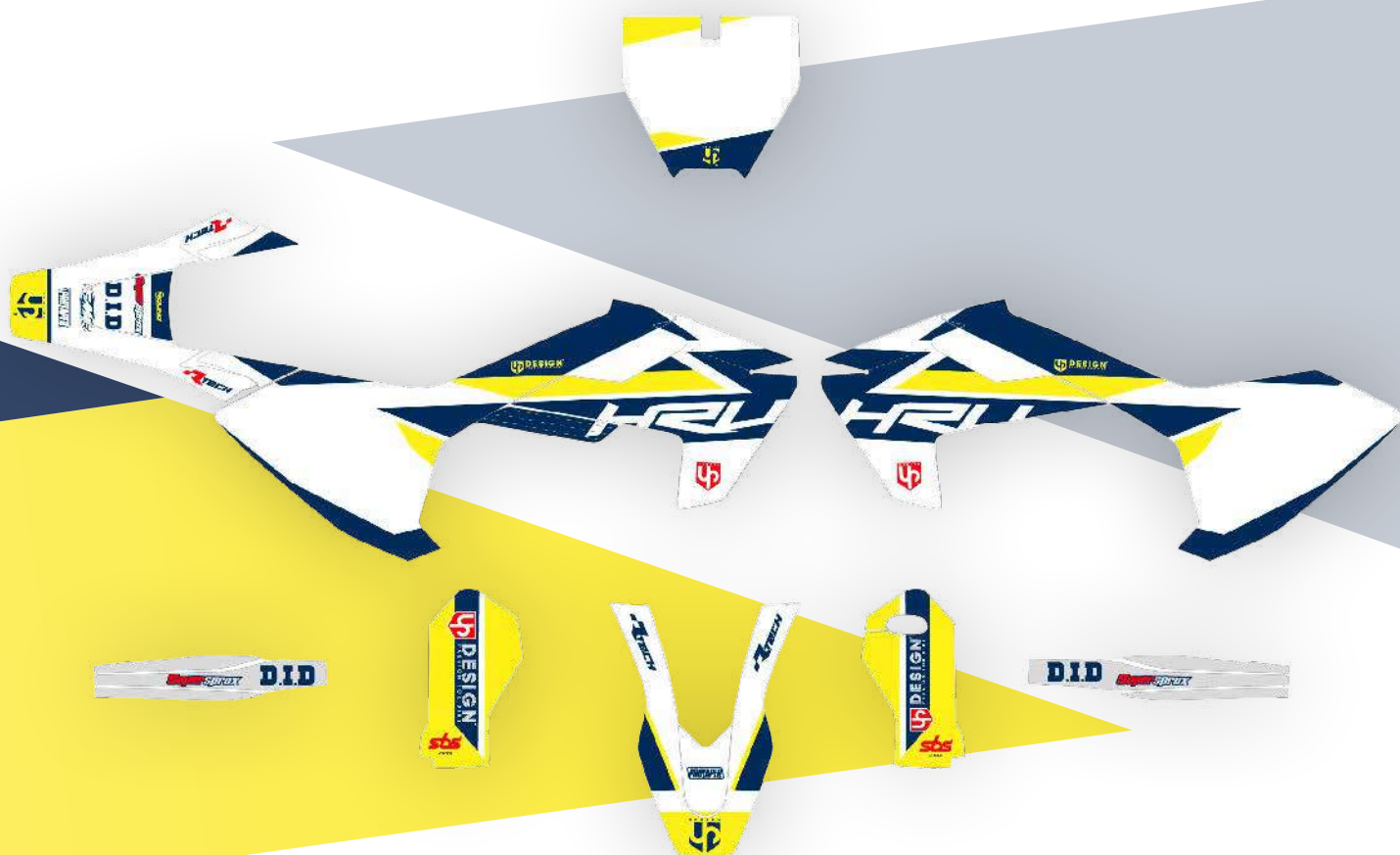

Neuf éléments à coller.

Complétez votre personnalisation
ou remise à neuf avec une housse
de selle page 180



design by *Kutvey*

Applications ROUND et SPIKE p. 178-179



Applications ROUND et SPIKE p. 178-179

Complétez votre
personnalisation ou
remise à neuf avec
une housse de selle
p. 180



KIT DÉCO HUSQVARNA FC / FE



SPiKe

S E R I E

99,90 €
T.T.C.

design by Kutvey

Huit éléments à coller.

Le kit ne comprend pas les fonds de plaque
avant et latéraux



Applications ROUND et SPIKE p. 178-179

Complétez votre
personnalisation ou
remise à neuf avec
une housse de selle
p. 180



KIT DÉCO HUSQVARNA TC 65



SPiKe
SERIE

99,90 €
T.T.C.

design by Kutvey

Neuf éléments à coller.



KIT DÉCO GASGAS MC

ROUND

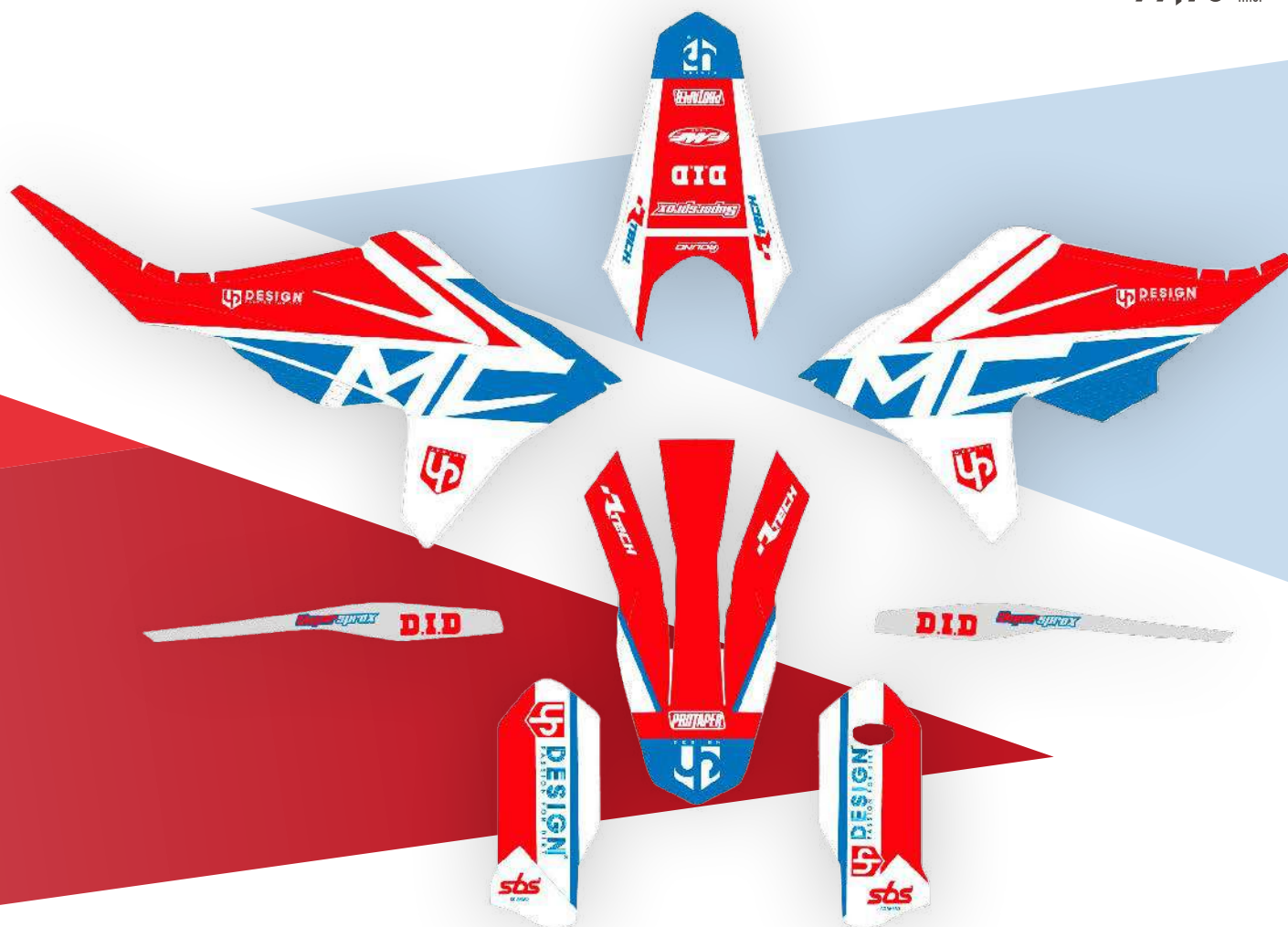
 99,90 €
I.T.C.

Huit éléments à coller.

Le kit ne comprend pas les fonds de plaque avant et latéraux

**Complétez votre personnalisation
ou remise à neuf avec une housse
de selle page 180**



design by Kutvey

Applications ROUND et SPIKE p. 178-179



Applications ROUND et SPIKE p. 178-179

Complétez votre
personnalisation ou
remise à neuf avec
une housse de selle
p. 180



KIT DÉCO GASGAS MC



SPiKe

S E R I E

99,90 €
T.T.C.

design by Kutvey

Huit éléments à coller.

Le kit ne comprend pas les fonds de plaque
avant et latéraux



KIT DÉCO

KAWASAKI KXF 450

ROUND

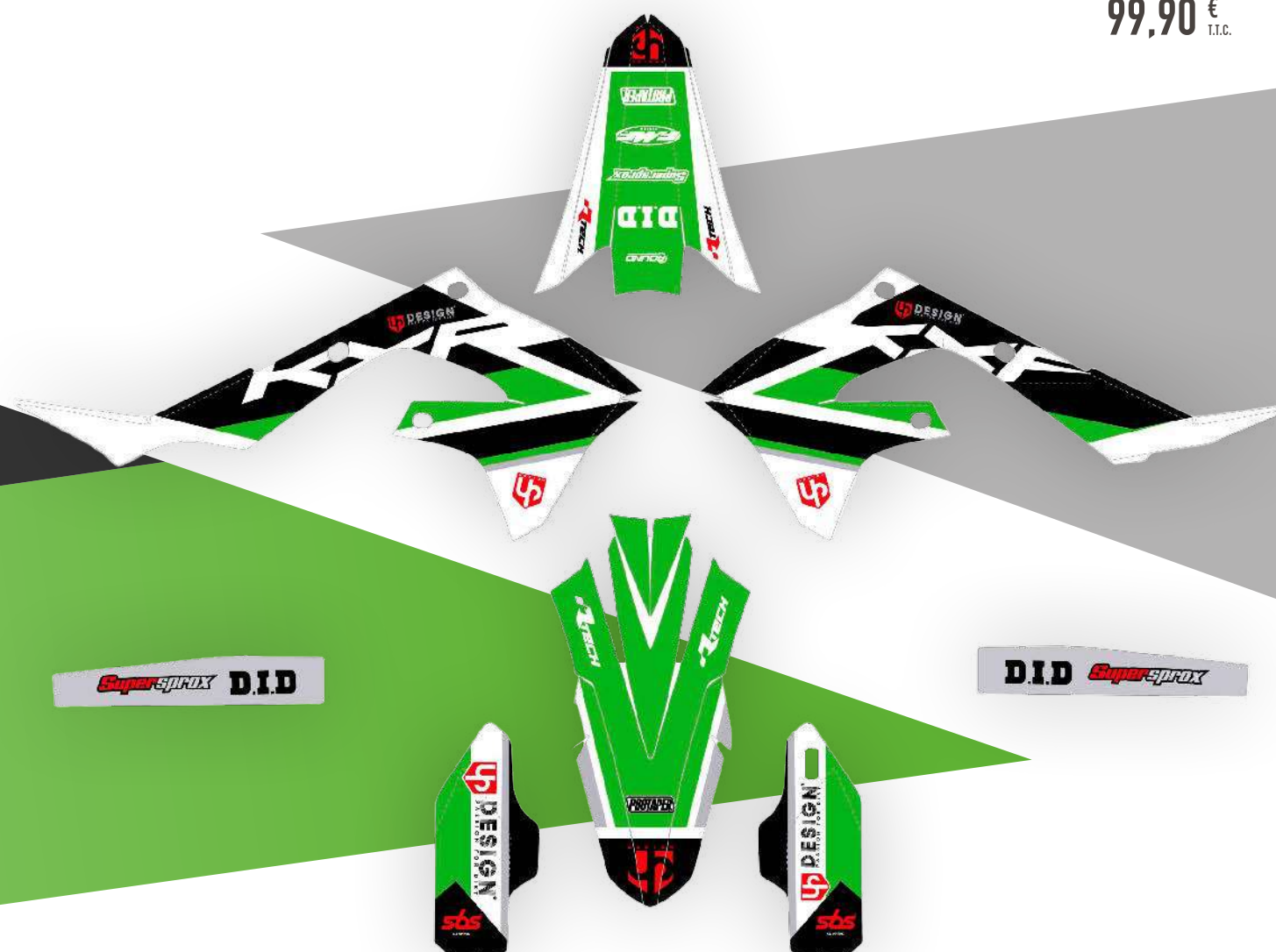
 99,90 €
T.T.C.

Huit éléments à coller.

Le kit ne comprend pas les fonds de plaque avant et latéraux

**Complétez votre personnalisation
ou remise à neuf avec une housse
de selle page 180**



design by Kutvey

Applications ROUND et SPIKE p. 178-179



Applications ROUND et SPIKE p. 178-179

Complétez votre
personnalisation ou
remise à neuf avec
une housse de selle
p. 180



KIT DÉCO KAWASAKI KXF 450



SPiKe

S E R I E

99,90 €
T.T.C.

design by Kutvey

Huit éléments à coller.

Le kit ne comprend pas les fonds de plaque
avant et latéraux



KIT DÉCO

HONDA CRF 450

ROUND

 99,90 €
I.T.C.

Huit éléments à coller.

Le kit ne comprend pas les fonds de plaque avant et latéraux

Complétez votre personnalisation ou remise à neuf avec une housse de selle page 180



design by *Kutvey*

Applications ROUND et SPIKE p. 178-179



Applications ROUND et SPIKE p. 178-179

Complétez votre
personnalisation ou
remise à neuf avec
une housse de selle
p. 180



KIT DÉCO HONDA CRF 450



SPiKe

S E R I E

99,90 €
T.T.C.

design by *Kutvey*

Huit éléments à coller.

Le kit ne comprend pas les fonds de plaque
avant et latéraux



KIT DÉCO

SHERCO SEF / SE

ROUND

 99,90 €
T.T.C.

Huit éléments à coller.

Le kit ne comprend pas les fonds de plaque avant et latéraux

Complétez votre personnalisation ou remise à neuf avec une housse de selle page 180



design by Kutvey

Applications ROUND et SPIKE p. 178-179



Applications ROUND et SPIKE p. 178-179

Complétez votre
personnalisation ou
remise à neuf avec
une housse de selle
p. 180



KIT DÉCO SHERCO SEF / SE



SPiKe

S E R I E

99,90 €
T.T.C.

design by Kutvey

Huit éléments à coller.

Le kit ne comprend pas les fonds de plaque
avant et latéraux



KIT DÉCO

SUZUKI RMZ 450

ROUND

99,90 €
I.T.C.

Huit éléments à coller.

Le kit ne comprend pas les fonds de plaque avant et latéraux

Complétez votre personnalisation ou remise à neuf avec une housse de selle page 180



design by Kutvey

Applications ROUND et SPIKE p. 178-179



Applications ROUND et SPIKE p. 178-179

Complétez votre
personnalisation ou
remise à neuf avec
une housse de selle
p. 180



KIT DÉCO SUZUKI RMZ 450



SPiKe

S E R I E

99,90 €
T.T.C.

design by Kutvey

Huit éléments à coller.

Le kit ne comprend pas les fonds de plaque
avant et latéraux



KIT DÉCO BETA RR

ROUND

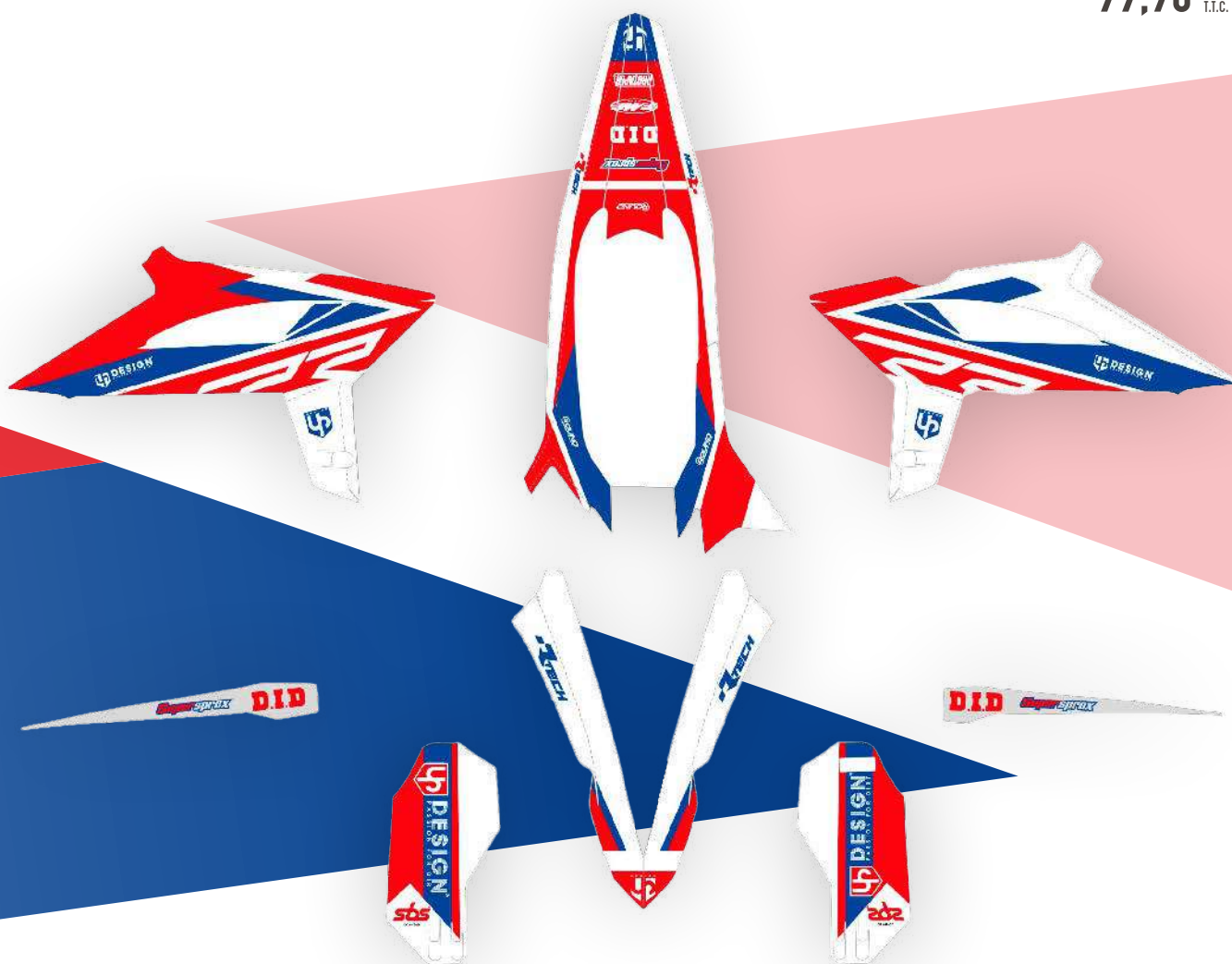
 99,90 €
I.T.C.

Huit éléments à coller.

Le kit ne comprend pas les fonds de plaque avant et latéraux

**Complétez votre personnalisation
ou remise à neuf avec une housse
de selle page 180**



design by Kutvey

Applications ROUND et SPIKE p. 178-179



Applications ROUND et SPIKE p. 178-179

Complétez votre
personnalisation ou
remise à neuf avec
une housse de selle
p. 180



KIT BETA RR



SPiKe

S E R I E

99,90 €
T.T.C.

design by Kutvey

Huit éléments à coller.

Le kit ne comprend pas les fonds de plaque
avant et latéraux



Marque / Modèle	Référence	€ T.T.C.
BETA		
RR (2020-2022)	1564436002L	99,90 €
RR (2019)	1563436002L	99,90 €
RR (2018)	1562436002L	99,90 €
GASGAS		
EC (2021-2022)	1589436002L	99,90 €
EC (2018-2020)	2327436002L	99,90 €
EC (2014-2017)	2314436002L	99,90 €
EC (2012)	2346436002L	99,90 €
MC (2022-2022)	1600436002L	99,90 €
MC 50 (2021-2022)	1592436002L	99,90 €
MC 65 (2021-2022)	1593436002L	99,90 €
MC 85 (2021-2022)	1594436002L	99,90 €
HONDA		
CRF 250 R (2022-2022)	1638436002L	99,90 €
CRF 250 R (2019-2021)	1637436002L	99,90 €
CRF 250 R (2018)	1636436002L	99,90 €
CRF 250 R (2014-2017)	1635436002L	99,90 €
CRF 250 R (2010-2013)	1634436002L	99,90 €
CRF 450 R (2021-2022)	1652436002L	99,90 €
CRF 450 R (2019-2020)	1651436002L	99,90 €
CRF 450 R (2017-2018)	1650436002L	99,90 €
CRF 450 R (2013-2016)	1649436002L	99,90 €
CRF 450 R (2009-2012)	1648436002L	99,90 €
CRF 50 (2013-2022)	1604436002	99,90 €
HUSQVARNA		
FC (2019-2022)	1733436004L	99,90 €
FC (2016-2018)	1732436004L	99,90 €
FE-TE (2020-2022)	1763436004L	99,90 €
FE-TE (2017-2019)	1762436004L	99,90 €
FE-TE(2016)	1761436004L	99,90 €
TC (2019-2022)	1728436004L	99,90 €
TC (2017-2018)	1727436004L	99,90 €
TC 65 (2019-2022)	1710436004L	99,90 €
TC 85 (2018-2022)	1713436004L	99,90 €
TC 85 (2015-2017)	1712436004L	99,90 €
TC 50 (2020-2022)	1708436007S	99,90 €
TC 50 (2019)	1707436007S	99,90 €
KAWASAKI		
KX 250 F (2021-2022)	1819436003L	99,90 €
KX 250 F (2017-2020)	1818436003L	99,90 €
KX 450 F (2020-2022)	1826436003L	99,90 €
KX 450 F (2019)	1825436003L	99,90 €
KX 450 F (2016-2018)	1824436003L	99,90 €
KX 65 (2000-2022)	1797436003L	99,90 €
KX 85 (2022-2022)	1801436003L	99,90 €
KX 85 (2014-2021)	1800436003L	99,90 €

Marque / Modèle	Référence	€ T.T.C.
KTM		
EXC-EXC-F (2020-2022)	1885436007L	99,90 €
EXC-EXC-F (2017-2019)	1884436007L	99,90 €
EXC-EXC-F (2016)	1883436007L	99,90 €
SX-SXF (2019-2022)	1958436007L	99,90 €
SX-SXF (2017-2018)	1957436007L	99,90 €
SX 50 (2020-2022)	1832436007L	99,90 €
SX 50 (2019)	1831436007L	99,90 €
SX 65 (2019-2022)	1838436007L	99,90 €
SX 85 (2018-2022)	1843436007L	99,90 €
SX 85 (2015-2017)	1842436007L	99,90 €
SHERCO		
SE-SEF (2019-2022)	2020436001L	99,90 €
SE-SEF (2017-2018)	2019436001L	99,90 €
SUZUKI		
RM 85 (2002-2022)	2111436008L	99,90 €
RMZ 250 (2019-2022)	2127436008L	99,90 €
RMZ 450 (2018-2022)	2131436008L	99,90 €
YAMAHA		
PW 50 (1981-2022)	2190436001	33,90 €
PW 80 (1983-2012)	2191436001	66,90 €
WR 250 F (2020-2022)	2256436001L	99,90 €
WR 250 F (2015-2019)	2255436001L	99,90 €
WR 450 F (2019-2022)	2263436001L	99,90 €
WR 450 F (2016-2018)	2262436001L	99,90 €
YZ (2022-2022)	2216436001L	99,90 €
YZ (2021)	2215436001L	99,90 €
YZ (2015-2020)	2214436001L	99,90 €
YZ 250 F (2019-2022)	2237436001L	99,90 €
YZ 250 F (2014-2018)	2236436001L	99,90 €
YZ 450 F (2018-2022)	2245436001L	99,90 €
YZ 450 F (2014-2017)	2244436001L	99,90 €
YZ 65 (2018-2022)	2199436001L	99,90 €
YZ 85 (2022)	2204436001L	99,90 €
YZ 85 (2019-2021)	2203436001L	99,90 €

design by Kutvey



Marque / Modèle	Référence	€ T.T.C.
BETA		
RR (2020-2022)	1564435029L	99,90 €
RR (2019)	1563435029L	99,90 €
RR (2018)	1562435029L	99,90 €
GASGAS		
EC (2021-2022)	1589435029L	99,90 €
EC (2018-2020)	2327435029L	99,90 €
EC (2014-2017)	2314435029L	99,90 €
EC (2012)	2346435029L	99,90 €
MC (2022-2022)	1600435029L	99,90 €
MC 50 (2021-2022)	1592435029L	99,90 €
MC 65 (2021-2022)	1593435029L	99,90 €
MC 85 (2021-2022)	1594435029L	99,90 €
HONDA		
CRF 250 R (2022-2022)	1638435029L	99,90 €
CRF 250 R (2019-2021)	1637435029L	99,90 €
CRF 250 R (2018)	1636435029L	99,90 €
CRF 250 R (2014-2017)	1635435029L	99,90 €
CRF 250 R (2010-2013)	1634435029L	99,90 €
CRF 450 R (2021-2022)	1652435029L	99,90 €
CRF 450 R (2019-2020)	1651435029L	99,90 €
CRF 450 R (2017-2018)	1650435029L	99,90 €
CRF 450 R (2013-2016)	1649435029L	99,90 €
CRF 450 R (2009-2012)	1648435029L	99,90 €
CRF 50 (2013-2022)	1604435029	99,90 €
HUSQVARNA		
FC (2019-2022)	1733435052L	99,90 €
FC (2016-2018)	1732435052L	99,90 €
FE-TE (2020-2022)	1763435052L	99,90 €
FE-TE (2017-2019)	1762435052L	99,90 €
FE-TE (2016)	1761435052L	99,90 €
TC (2019-2022)	1728435052L	99,90 €
TC (2017-2018)	1727435052L	99,90 €
TC 65 (2019-2022)	1710435052L	99,90 €
TC 85 (2018-2022)	1713435052L	99,90 €
TC 85 (2015-2017)	1712435052L	99,90 €
TC 50 (2020-2022)	1708435043S	99,90 €
TC 50 (2019)	1707435043S	99,90 €
KAWASAKI		
KX 250 F (2021-2022)	1819435037L	99,90 €
KX 250 F (2017-2020)	1818435037L	99,90 €
KX 450 F (2020-2022)	1826435037L	99,90 €
KX 450 F (2019)	1825435037L	99,90 €
KX 450 F (2016-2018)	1824435037L	99,90 €
KX 65 (2000-2022)	1797435037L	99,90 €
KX 85 (2022-2022)	1801435037L	99,90 €
KX 85 (2014-2021)	1800435037L	99,90 €

Marque / Modèle	Référence	€ T.T.C.
KTM		
EXC-EXC-F (2020-2022)	1885435043L	99,90 €
EXC-EXC-F (2017-2019)	1884435043L	99,90 €
EXC-EXC-F (2016)	1883435043L	99,90 €
SX-SXF (2019-2022)	1958435043L	99,90 €
SX-SXF (2017-2018)	1957435043L	99,90 €
SX 50 (2020-2022)	1832435043L	99,90 €
SX 50 (2019)	1831435043L	99,90 €
SX 65 (2019-2022)	1838435043L	99,90 €
SX 85 (2018-2022)	1843435043L	99,90 €
SX 85 (2015-2017)	1842435043L	99,90 €
SHERCO		
SE-SEF (2019-2022)	2020435038L	99,90 €
SE-SEF (2017-2018)	2019435038L	99,90 €
SUZUKI		
RM 85 (2002-2022)	2111435017L	99,90 €
RMZ 250 (2019-2022)	2127435017L	99,90 €
RMZ 450 (2018-2022)	2131435017L	99,90 €
YAMAHA		
PW 50 (1981-2022)	2190435038	33,90 €
PW 80 (1983-2012)	2191435038	66,90 €
WR 250 F (2020-2022)	2256435038L	99,90 €
WR 250 F (2015-2019)	2255435038L	99,90 €
WR 450 F (2019-2022)	2263435038L	99,90 €
WR 450 F (2016-2018)	2262435038L	99,90 €
YZ (2022-2022)	2216435038L	99,90 €
YZ (2021)	2215435038L	99,90 €
YZ (2015-2020)	2214435038L	99,90 €
YZ 250 F (2019-2022)	2237435038L	99,90 €
YZ 250 F (2014-2018)	2236435038L	99,90 €
YZ 450 F (2018-2022)	2245435038L	99,90 €
YZ 450 F (2014-2017)	2244435038L	99,90 €
YZ 65 (2018-2022)	2199435038L	99,90 €
YZ 85 (2022)	2204435038L	99,90 €
YZ 85 (2019-2021)	2203435038L	99,90 €



HOUSSE DE SELLE



Honda



Modèle	Années	Référence	€ T.T.C.
CRF 250R	10-13	HDSCRF3NR HDSCRF3N	76,90 65,90
CRF 450R	09-12	HDSCRF3NR HDSCRF3N	76,90 65,90
CRF 250R	14-17	HDSCRF4NR HDSCRF4N	76,90 65,90
CRF 450R	13-16	HDSCRF4NR HDSCRF4N	76,90 65,90
CRF 250R	2020	HDSCRF6NR HDSCRF6N	76,90 65,90
CRF 450R	17-20	HDSCRF6NR HDSCRF6N	76,90 65,90

Husqvarna



Modèle	Années	Référence	€ T.T.C.
TC 65	18>	HDSTC2NBL HDSTC2N	76,90 65,90
TC 85	18>	HDSTC3NBL HDSTC3N	76,90 65,90
FC/FE/ TC/TE	14-15	HDSHUSALL1NBL HDSHUSALL1N	76,90 65,90
FC/FE/ TC/TE	16-20	HDSHUSALL2NBL HDSHUSALL2N	76,90 65,90

Kawasaki



Modèle	Années	Référence	€ T.T.C.
KX 80, 85 et 100	14-20	HDSKX3NV HDSKX3N	76,90 65,90
KXF 250	09-12	HDSKXF2NV HDSKXF2N	76,90 65,90
KXF 450	09-11	HDSKXF2NV HDSKXF2N	76,90 65,90
KXF 250	13-20	HDSKXF3NV HDSKXF3N	76,90 65,90
KXF 450	12-20	HDSKXF3NV HDSKXF3N	76,90 65,90

KTM



Modèle	Années	Référence	€ T.T.C.
SX 85	13-16	HDSSX5NO HDSSX5N	76,90 65,90
SX 85	17-20	HDSSX6NO HDSSX6N	76,90 65,90
SX/SX-F 125-450	11-16	HDSKTMALL3NO HDSKTMALL3N	76,90 65,90
EXC/ EXC-F 125-530	12-16	HDSKTMALL3NO HDSKTMALL3N	76,90 65,90
XC/XCW	11-15	HDSKTMALL3NO HDSKTMALL3N	76,90 65,90
SX/SX-F 125-450	17-20	HDSKTMALL4NO HDSKTMALL4N	76,90 65,90
EXC/ EXC-F 125-530	17-20	HDSKTMALL4NO HDSKTMALL4N	76,90 65,90
XC/XCW	16-20	HDSKTMALL4NO HDSKTMALL4N	76,90 65,90

Suzuki



Modèle	Années	Référence	€ T.T.C.
RMZ 250	10-20	HDSRMZ3NJ HDSRMZ3N	76,90 65,90
RMZ 450	08-16	HDSRMZ5NJ HDSRMZ5N	76,90 65,90
RMZ 450	18-20	HDSRMZ6NJ HDSRMZ6N	76,90 65,90

Yamaha



Modèle	Années	Référence	€ T.T.C.
YZ 85	16-20	HDSYZ2NB HDSYZ2N	76,90 65,90
YZ 125/250	02-20	HDSYZ3NB HDSYZ3N	76,90 65,90
YZF 250/450	06-09	HDSYZF2NB HDSYZF2N	76,90 65,90
YZF 250	10-13	HDSYZF3NB HDSYZF3N	76,90 65,90
YZF 450	10-13	HDSYZF4NB HDSYZF4N	76,90 65,90
YZF 250/450	14-17	HDSYZF5NB HDSYZF5N	76,90 65,90
YZF 450	18-20	HDSYZF6NB HDSYZF6N	76,90 65,90
WRF 250/450	07-16	HDSWRF1NB HDSWRF1N	76,90 65,90

Les références housse de selle
noire se termine par la lettre "N" ;
dans les tableaux ci-dessus



design by Kutvey



NUMÉROS



160 x 75 mm



130 x 70 mm

Lot de 3x "un numéro"**2,30 €** I.T.C.**Pack de 30****22,90 €** I.T.C.Soit 3x "chaque numéro",
de "0" à "9"

Lot / Pack 160x75 mm	Blanc	Noir
Lot de 3 "0"	NUM160B	NUM160N
Lot de 3 "1"	NUM161B	NUM161N
Lot de 3 "2"	NUM162B	NUM162N
Lot de 3 "3"	NUM163B	NUM163N
Lot de 3 "4"	NUM164B	NUM164N
Lot de 3 "5"	NUM165B	NUM165N
Lot de 3 "6"	NUM166B	NUM166N
Lot de 3 "7"	NUM167B	NUM167N
Lot de 3 "8"	NUM168B	NUM168N
Lot de 3 "9"	NUM169B	NUM169N
Pack 30 3 exemplaires de chaque numéro de 0 à 9	SERI16B	SERI16N

Lot / Pack 130x70 mm	Blanc	Noir
Lot de 3 "0"	NUM130B	NUM130N
Lot de 3 "1"	NUM131B	NUM131N
Lot de 3 "2"	NUM132B	NUM132N
Lot de 3 "3"	NUM133B	NUM133N
Lot de 3 "4"	NUM134B	NUM134N
Lot de 3 "5"	NUM135B	NUM135N
Lot de 3 "6"	NUM136B	NUM136N
Lot de 3 "7"	NUM137B	NUM137N
Lot de 3 "8"	NUM138B	NUM138N
Lot de 3 "9"	NUM139B	NUM139N
Pack 30 3 exemplaires de chaque numéro de 0 à 9	SERI13B	SERI13N



© MxJuly

PLASTIQUES RTECH

HONDA



Grille de radiateur

Protection totale de la partie inférieure du radiateur standard. Elle recouvre entièrement le plateau qui, dans la version standard, reste exposé aux chocs de la terre et de la pierre.

MOD	CC	ANNEE	NOTES	COULEUR	RÉFÉRENCE	PRIX
CRF	250	2018-2019	Oversize pour radiateur d'orig.	Noir	■ RGRCRFNR0018	€ 36,95
CRF	250	2020-2021	Oversize pour radiateur d'orig.	Noir	■ RGRCRFNR0020	€ 36,95
CRF-RX	250	2019	Oversize pour radiateur d'orig.	Noir	■ RGRCRFNR0018	€ 36,95
CRF-RX	250	2020-2021	Oversize pour radiateur d'orig.	Noir	■ RGRCRFNR0020	€ 36,95
CRF/CRF-RX	250	2022	Pour radiateur d'orig.	Noir	■ RGRCRFNR0021	€ 36,95
CRF / CRF-RX	450	2017 > 2020	Oversize pour radiateur d'orig.	Noir	■ RGRCRFNR0017	€ 36,95
CRF/CRF-RWE	450	2021-2022	Pour radiateur d'orig.	Noir	■ RGRCRFNR0021	€ 36,95
CRF-RX						
CRF-RWE	450	2019-2020	Oversize pour radiateur d'orig.	Noir	■ RGRCRFNR0017	€ 36,95

Protection de fourche



RPSCRFRS0019

RPSCRFBN0019

RPSCRFN0019



OEM Couleur d'orig. - * Fluo

MOD	CC	ANNEE	NOTES	COULEUR	RÉFÉRENCE	PRIX
CR	125-250-500	1990 > 2007	OEM	Neutre	RPSCRONT0003	€ 34,95
				Blanc	RPSCR0BN0003	
				Noir	RPSCR0NR0003	
				CR Rouge	RPSCR0RS0003	
				Jaune fluo	RPSCR0GF0003	
CRF	250	2004 > 2018	OEM 2017-2018 OEM 2004 > 2016	CR Rouge	RPSCR0RS0003	€ 34,95
				Neutre	RPSCRONT0003	
				Blanc	RPSCR0BN0003	
				Noir	RPSCR0NR0003	
				Jaune fluo	RPSCR0GF0003	
CRF	450	2002 > 2018	OEM 2017-2018 OEM 2002 > 2016	CR Rouge	RPSCR0RS0003	€ 34,95
				Neutre	RPSCRONT0003	
				Blanc	RPSCR0BN0003	
				Noir	RPSCR0NR0003	
				Jaune fluo	RPSCR0GF0003	
CRF-RX	450	2017-2018	Sans guide câble compteur OEM	CR Rouge	RPSCR0RS0003	€ 34,95
				Neutre	RPSCRONT0003	
				Blanc	RPSCR0BN0003	
				Noir	RPSCR0NR0003	
				Jaune fluo	RPSCR0GF0003	
CRFX	250	2004 > 2019	Sans guide câble compteur OEM	CR Rouge	RPSCR0RS0003	€ 34,95
				Neutre	RPSCRONT0003	
				Blanc	RPSCR0BN0003	
				Noir	RPSCR0NR0003	
				Jaune fluo	RPSCR0GF0003	
CRFX	450	2005 > 2017	Sans guide câble compteur OEM	CR Rouge	RPSCR0RS0003	€ 34,95
				Neutre	RPSCRONT0003	
				Blanc	RPSCR0BN0003	
				Noir	RPSCR0NR0003	
				Jaune fluo	RPSCR0GF0003	
CRF/CRF-RWE	250-450	2019 > 2022	OEM	CR Rouge	RPSCRFRS0019	€ 34,95
				Blanc	RPSCRFBN0019	
				Noir	RPSCRFN0019	

Bavette d'amortisseur

18,95 €
T.T.C.

RPSPCRFNR017

OEM Couleur d'orig.

MOD	CC	ANNEE	NOTES	COULEUR	RÉFÉRENCE
CR	125-500	1993 > 2007		Noir	RPSPCR0NR000
CR	250	1992 > 2007		Noir	RPSPCR0NR000
CRF	250	2010 > 2013		Noir	RPSPCR0NR000
CRF	250	2014 > 2017		Noir	RPSPCRFNR013
CRF	250	2018 > 2021		Noir	RPSPCRFNR017
CRF/CRF-RX	250	2022		Noir	RPSPCRFNR021
CRF	450	2002 > 2012		Noir	RPSPCR0NR000
CRF	450	2013 > 2016		Noir	RPSPCRFNR013
CRF / CRF-RX	450	2017 > 2020		Noir	RPSPCRFNR017
CRFX	450	2005 > 2017		Noir	RPSPCR0NR000
CRF-RX	250	2019 > 2021		Noir	RPSPCRFNR017
CRFX	450	2019 > 2022		Noir	RPSPCRFNR017
CRF-L	450	2019 > 2021		Noir	RPSPCRFNR017
CRF-RWE	450	2019-2020		Noir	RPSPCRFNR017
CRF / CRF-RX CRF-RWE	450	2021-2022		Noir	RPSPCRFNR021

Guide chaîne

23,95 €
T.T.C.

RCRUCRNR007

OEM Couleur d'orig.

MOD	CC	ANNEE	NOTES	COULEUR	RÉFÉRENCE
CR	125-250	2005 > 2007	OEM	Noir	RCRUCRNR0005
CR	125-250-500	1999 > 2004	OEM	Noir	RCRUCRNR0003
CRF / CRFX	250	2004	OEM	Noir	RCRUCRNR0003
CRF / CRFX	250-450	2005-2006	OEM	Noir	RCRUCRNR0005
CRF / CRFX	250-450	2007 > 2022	OEM	Noir	RCRUCRNR0007
CRF-RX / CRF-L CRF	450	2002 > 2004	OEM	Noir	RCRUCRNR0003

GUIDE CHAÎNE MONOBLOCK R2.0 WORX
P. 2XX

Patin de bras oscillant

25,95 €
T.T.C.

RSLICRFNR019

OEM Couleur d'orig.

MOD	CC	ANNEE	NOTES	COULEUR	RÉFÉRENCE
CR	125-250-500	2000 > 2007	OEM	Noir	RSLICRNR0003
CRF	250	2004 > 2009	OEM	Noir	RSLICRNR0003
CRF	250	2010 > 2013	OEM	Noir	RSLICRFNR009
CRF	250	2014 > 2017	OEM	Noir	RSLICRFNR013
CRF	250	2018-2019	OEM	Noir	RSLICRFNR017
CRF / CRF-RX	250	2020 > 2022	OEM	Noir	RSLICRFNR019
CRF	450	2002 > 2008	OEM	Noir	RSLICRNR0003
CRF	450	2009 > 2012	OEM	Noir	RSLICRFNR009
CRF	450	2013 > 2016	OEM	Noir	RSLICRFNR013
CRF / CRF-RX	450	2017-2018	OEM	Noir	RSLICRFNR017
CRFX	250	2004 > 2017	OEM	Noir	RSLICRNR0003
CRFX	450	2005 > 2017	OEM	Noir	RSLICRNR0003
CRF-RX	250	2019	OEM	Noir	RSLICRFNR017
CRF/CRF-RX CRF-RWE	450	2019 > 2022	OEM	Noir	RSLICRFNR019

Kits plastiques

CRF  **EVOLUTION**

CRF 250 2022

CRF 450 2021-2022

CRF-RWE 450 2021-2022

NOUVEAUTÉ

179,95 €
I.T.C.

RKITCRFRS0522

**Nouveau design CRF 21/22,
kit plastique composé de :**

- nouvelle plaque avant factory
- nouvelles ouïes de radiateurs plus fines et modernes
- nouvelles plaques latérales aérodynamiques
- garde-boue avant ventilé
- garde-boue arrière renforcé
- protections de fourche

AVANT



APRÈS



Kits plastiques



RKITCRFRS0521

OEM Couleur d'orig. - ☀ Fluo

MOD	CC	ANNEE	NOTES	COULEUR	RÉFÉRENCE	PRIX
CR	125-250	2004 > 2007		OEM	RKITCR00EM503	€ 129,95
				CR Rouge	RKITCR0RS0503	
CRF	250	2010		OEM	RKITCRFOEM513	€ 129,95
Garde-boue avant ventilé				CR Rouge	RKITCRFRS0513	
CRF	250	2010 > 2013		OEM	RKITCRFOEM513	€ 129,95
Garde-boue avant ventilé				CR Rouge	RKITCRFRS0513	
CRF	250	2011 > 2013		OEM	RKITCRFOEM516	€ 129,95
Garde-boue avant ventilé				CR Rouge	RKITCRFRS0516	
CRF	250	2014 > 2017	OEM avec couv. boîte à air	OEM	RKITCRFOEM517	€ 149,95
Garde-boue avant ventilé				Blanc	RKITCRFBN0517	
				CR Rouge	RKITCRFRS0517	
				Noir	RKITCRFNR0517	
CRF	250	2014 > 2017	OEM avec couv. boîte à air	OEM	RKITCRFOEM518	€ 149,95
Garde-boue avant ventilé				CR Rouge	RKITCRFRS0518	
CRF	250	2018		OEM	RKITCRFOEM599	€ 149,95
Garde-boue avant ventilé				CR Rouge	RKITCRFRS0599	
				Noir	RKITCRFNR0599	
				☀ Jaune fluo	RKITCRFGF0599	
CRF	250	2019 > 2021		OEM	RKITCRFOEM519	€ 149,95
Garde-boue avant ventilé				CR Rouge	RKITCRFRS0519	
				Noir	RKITCRFNR0519	
			Édition limitée	☀ Jaune fluo	RKITCRFGF0519	
				Gris	RKITCRFGR0519	
				CR Rouge/Noir	RKITCRFRWE519	
Avec protection de fourche et gas tank cover (Bleu)			Édition limitée	CR Rouge-YZ Bleu	RKITCRFRSB519	€ 164,95



MOD	CC	ANNEE	NOTES	COULEUR	RÉFÉRENCE	PRIX
CRF	250	2022	ac. couv. boîte air + protc. F	OEM CR Rouge	RKITCRFRS0721	€ 172,95
				CR Rouge	RKITCRFRS0521	€ 149,95
				Blanc	RKITCRFBN0521	
				Noir	RKITCRFNR0521	
				Gris	RKITCRFGR0521	
CRF	450	2009-2010		OEM	RKITCRFOEM513	€ 129,95
				CR Rouge	RKITCRFRS0513	
CRF	450	2011-2012		OEM	RKITCRFOEM516	€ 129,95
				CR Rouge	RKITCRFRS0516	
CRF	450	2009 > 2012		OEM	RKITCRFOEM513	€ 129,95
				CR Rouge	RKITCRFRS0513	
CRF	450	2013 > 2016	OEM avec couv. boîte à air	OEM	RKITCRFOEM517	€ 149,95
				CR Rouge	RKITCRFRS0517	
				Noir	RKITCRFNR0517	
CRF	450	2013 > 2016	OEM avec couv. boîte à air	OEM	RKITCRFOEM518	€ 149,95
				Blanc	RKITCRFBN0518	
				CR Rouge	RKITCRFRS0518	
CRF	450	2017-2018		OEM	RKITCRFOEM599	€ 149,95
				CR Rouge	RKITCRFRS0599	
				Noir	RKITCRFNR0599	
				Jaune fluo	RKITCRFGF0599	
CRF/CRF-RWE	450	2019-2020		OEM	RKITCRFOEM519	€ 149,95
				CR Rouge	RKITCRFRS0519	
				Noir	RKITCRFNR0519	
				Jaune fluo	RKITCRFGF0519	
				Gris	RKITCRFGR0519	
Avec protection de fourche et gas tank cover (Bleu)			Édition limitée	CR Rouge/YZ	RKITCRFRSB519	€ 164,95
				Bleu		
CRF/CRF-RWE	450	2021-2022	ac. couv. boîte air + protc. F	OEM CR Rouge	RKITCRFRS0721	€ 172,95
				CR Rouge	RKITCRFRS0521	€ 149,95
CRFX	250	2004 > 2019	OEM 2009 > 2019	OEM	RKITCRXOEM412	€ 124,95
				CR Rouge	RKITCRXRS0412	
CRFX	450	2005 > 2007		OEM	RKITCRXOEM414	€ 124,95
				CR Rouge	RKITCRXRS0414	
CRFX	450	2008 > 2017	OEM 2009 > 2017	OEM	RKITCRXOEM415	€ 124,95
				CR Rouge	RKITCRFRS0601	€ 159,95
CRF-RX	250	2019 > 2021		OEM	RKITCRFOEM601	€ 159,95
				CR Rouge	RKITCRFRS0601	
				Noir	RKITCRFNR0601	
CRF-RX	450	2017-2018		OEM	RKITCRFOEM600	€ 159,95
				CR Rouge	RKITCRFRS0600	
CRF-RX	450	2019-2020		OEM	RKITCRFOEM601	€ 159,95
				CR Rouge	RKITCRFRS0601	
CRF-RX	450			OEM	RKITCRFNR0601	
				Noir		

PLASTIQUES RTECH

YAMAHA

Grille de radiateur

36,95 €
T.T.C.



RGRYZFBL0018



RGRYZFBN0018

Protection totale de la partie inférieure du radiateur standard. Elle recouvre entièrement le plateau qui, dans la version standard, reste exposé aux chocs de la terre et de la pierre.

OEM Couleur d'orig. - Fluo

MODEL	CC	ANNEE	NOTES	COULEUR	RÉFÉRENCE
YZ	125-250	2022	OEM	Noir	<input checked="" type="checkbox"/> RGRYZONR0022
YZF	250	2019 > 2022	OEM 2020-2021	Blanc	<input type="checkbox"/> RGRYZFBN0018
				Neutre	<input type="checkbox"/> RGRYZFNT0018
				YZ Bleu	<input checked="" type="checkbox"/> RGRYZFBL0018
YZ-FX / WRF	250	2020 > 2022	OEM 2020-2021	Blanc	<input type="checkbox"/> RGRYZFBN0018
				Neutre	<input type="checkbox"/> RGRYZFNT0018
				YZ Bleu	<input checked="" type="checkbox"/> RGRYZFBL0018
YZF	450	2018 > 2022	OEM 2020-2021	Blanc	<input type="checkbox"/> RGRYZFBN0018
				Neutre	<input type="checkbox"/> RGRYZFNT0018
				YZ Bleu	<input checked="" type="checkbox"/> RGRYZFBL0018
WRF / YZ-FX	450	2019 > 2022	OEM 2020-2021	Blanc	<input type="checkbox"/> RGRYZFBN0018
				Neutre	<input type="checkbox"/> RGRYZFNT0018
				YZ Bleu	<input checked="" type="checkbox"/> RGRYZFBL0018

Protection de fourche



OEM Couleur d'orig. - ☀️ Fluo

MODEL	CC	ANNEE	NOTES	COULEUR	RÉFÉRENCE	PRIX
YZ	65	2018 > 2022	OEM 2018 > 2020	Blanc	RPSYZ0BN0065	€ 26,95
YZ	85	2002 > 2018	OEM	Blanc	RPSYZ0BN0085	€ 26,95
YZ	85	2019 > 2022	OEM 2019-2020	Blanc	RPSYZ0BN0185	€ 26,95
YZ	125-250	2005 > 2007	OEM	Blanc	RPSYZ0BN0005	€ 34,95
				YZ Bleu	RPSYZ0BL0005	
				Noir	RPSYZ0NR0005	
YZ	125-250	2008 > 2014	OEM	Blanc	RPSYZ0BN0008	€ 34,95
				YZ Bleu	RPSYZ0BL0008	
				Noir	RPSYZ0NR0008	
YZ	125-250	2015 > 2022	OEM 2015 > 2020 OEM 2022 OEM 2021	Blanc	RPSYZ0BN0010	€ 34,95
				YZ Bleu	RPSYZ0BL0010	
				Noir	RPSYZ0NR0010	
				Jaune fluo	RPSYZ0GF0010	
YZ-X	125	2020 > 2022	OEM 2020 OEM 2021	Blanc	RPSYZ0BN0010	€ 34,95
				Noir	RPSYZ0NR0010	
				YZ Bleu	RPSYZ0BL0010	
				Jaune fluo	RPSYZ0GF0010	
YZF	250-450	2005 > 2007	OEM	Blanc	RPSYZ0BN0005	€ 34,95
				YZ Bleu	RPSYZ0BL0005	
				Noir	RPSYZ0NR0005	
YZF	250-450	2008-2009	OEM	Blanc	RPSYZ0BN0008	€ 34,95
				YZ Bleu	RPSYZ0BL0008	
				Noir	RPSYZ0NR0008	
YZF	250-450	2010 > 2022	OEM 2010 > 2020 OEM 2021	Blanc	RPSYZ0BN0010	€ 34,95
				Noir	RPSYZ0NR0010	
				YZ Bleu	RPSYZ0BL0010	
				Jaune fluo	RPSYZ0GF0010	
YZ-FX	250-450	2015 > 2022	OEM 2015 > 2020 OEM 2021	Blanc	RPSYZ0BN0010	€ 34,95
				Noir	RPSYZ0NR0010	
				YZ Bleu	RPSYZ0BL0010	
				Jaune fluo	RPSYZ0GF0010	
YZ-X	250	2016 > 2022	OEM 2016 > 2020 OEM 2021	Blanc	RPSYZ0BN0010	€ 34,95
				Noir	RPSYZ0NR0010	
				YZ Bleu	RPSYZ0BL0010	
				Jaune fluo	RPSYZ0GF0010	
WRF	450	2005 > 2018	OEM - Sans guide câble compteur Sans guide câble compteur Sans guide câble compteur	Blanc	RPSYZ0BN0005	€ 34,95
				YZ Bleu	RPSYZ0BL0005	
				Noir	RPSYZ0NR0005	
WRF	250	2005 > 2019	OEM - Sans guide câble compteur Sans guide câble compteur Sans guide câble compteur	Blanc	RPSYZ0BN0005	€ 34,95
				YZ Bleu	RPSYZ0BL0005	
				Noir	RPSYZ0NR0005	
WRF	250	2020 > 2022	OEM 2020 - Avec guide câble compteur Avec guide câble compteur	Blanc	RPSWRFBN0019	€ 34,95
				YZ Bleu	RPSWRFBL0019	
				Noir	RPSWRFNR0019	
WRF	450	2019 > 2022	OEM 2020 - Avec guide câble compteur Avec guide câble compteur OEM 2021 - Avec guide câble compteur	Blanc	RPSWRFBN0019	€ 34,95
				YZ Bleu	RPSWRFBL0019	
				Noir	RPSWRFNR0019	

Bavette d'amortisseur

18,95 €
T.T.C.

OEM Couleur d'orig.

RSPYZ0NR010

MODEL	CC	ANNEE	NOTES	COULEUR	RÉFÉRENCE
YZ/YZ-X/WR	125-250	1996 > 2022	OEM	Noir	RSPYZ0NR000
YZF	250-400-426-450	1998 > 2009	OEM	Noir	RSPYZ0NR000
YZF	250	2010 > 2018	OEM	Noir	RSPYZ0NR010
YZF	250	2019 > 2022	OEM	Noir	RSPYZ0NR000
YZ-FX	250	2015 > 2019	OEM	Noir	RSPYZ0NR010
YZ-FX	250	2020 > 2022	OEM	Noir	RSPYZ0NR000
YZF	450	2010 > 2013	OEM	Noir	RSPYZ0NR011
YZF	450	2014 > 2017	OEM	Noir	RSPYZ0NR010
YZF	450	2018 > 2022	OEM	Noir	RSPYZ0NR000
YZ-FX	450	2016 > 2018	OEM	Noir	RSPYZ0NR010
YZ-FX	450	2019 > 2022	OEM	Noir	RSPYZ0NR000
WRF	250-400-426-450	1998 > 2022	OEM	Noir	RSPYZ0NR000

Guide chaîne

23,95 €
T.T.C.

OEM Couleur d'orig.

RCRUYZNR0007

MODEL	CC	ANNEE	NOTES	COULEUR	RÉFÉRENCE
YZ / WR	125-250	1997 > 2004	OEM	Noir	RCRUYZNR0003
YZ / YZF / WRF	125-250-450	2005-2006	OEM	Noir	RCRUYZNR0005
YZ	125-250-450	2007 > 2022	OEM	Noir	RCRUYZNR0007
YZ-X	125	2007 > 2022	OEM	Noir	RCRUYZNR0007
YZF / WRF	250-400-426-450	1997 > 2004	OEM	Noir	RCRUYZNR0003
YZF	250-450	2007 > 2022	OEM	Noir	RCRUYZNR0007
YZ-X	250	2007 > 2022	OEM	Noir	RCRUYZNR0007
YZ-FX / WRF	250-450	2007 > 2022	OEM	Noir	RCRUYZNR0007

GUIDE CHAÎNE MONOBLOCK R2.0 WORX
P. 2XX

Patin de bras oscillant

25,95 €
T.T.C.

RSLIYZNR0009

OEM Couleur d'orig.

MODEL	CC	ANNEE	NOTES	COULEUR	RÉFÉRENCE
YZ / WR	125-250	1997 > 2004	OEM	Noir	RSLIYZNR0003
YZ/YZ-X	125-250	2005 > 2022	OEM	Noir	RSLIYZNR0005
YZF / WRF	250-400-426-450	1998 > 2004	OEM	Noir	RSLIYZNR0003
YZF	250-450	2005 > 2008	OEM	Noir	RSLIYZNR0005
YZF	250-450	2009 > 2022	OEM	Noir	RSLIYZNR0009
YZ-FX	250	2015 > 2022	OEM	Noir	RSLIYZNR0009
YZ-FX	450	2016 > 2022	OEM	Noir	RSLIYZNR0009
WRF	250	2005 > 2019	OEM	Noir	RSLIYZNR0005
WRF	250	2020 > 2022	OEM	Noir	RSLIYZNR0009
WRF	450	2005 > 2018	OEM	Noir	RSLIYZNR0005
WRF	450	2019 > 2022	OEM	Noir	RSLIYZNR0009

Kits plastiques

YZ/YZ-X **EVOLUTION**

159,95 €
T.T.C.

YZ/YZ-X 125-250

YZ 125-250 2002 > 2021

YZ 250 2016 > 2021



RKITYZ0BL0REV - Origine



RKITYZ0GR0REV - Gris



RKITYZ0BL1REV - Bleu YZ



Kit restylage YZ

149,95 €
I.T.C.

Mettre à jour une YZ 125-250 de 2002 à 2014 en version 2021



*Pour adapter la plaque numéro de 2015 sur les modèles de 2002 à 2005 il est nécessaire de commander aussi l'article **RSUPTABYZ015** (non inclus)



RKITYZ00EM000 - Couleur d'origine



Adaptateur de montage pour plaque numéro
RTBYZF_0010 sur les modèles YZ-YZF
125-250-400-426-450 2002 > 2005

18,95 €
I.T.C.



RKITYZ0BN0000 - Blanc



RKITYZ0NR0000 - Noir

Kits plastiques



RKITYZFOEM518

MODEL	CC	ANNEE	NOTES	COULEUR		RÉFÉRENCE	PRIX
YZ	65	2018 > 2022	OEM 2018 > 2020	OEM		RKITYZ00EM565	€ 109,95
YZ	85	2015 > 2021	OEM 2015 > 2020	OEM		RKITYZ00EM585	€ 159,95
			OEM 2021	OEM		RKITYZ0BL0585	
YZ	85	2022	OEM	OEM		RKITYZ0BL0085	€ 164,95
YZ	125-250	2002 > 2005		OEM		RKITYZ00EM502	€ 129,95
				Noir		RKITYZ0NR0502	
YZ / YZ-X	125-250	2002 > 2021	OEM 2002>2020	OEM		RKITYZ00EM000	€ 149,95
			For models 02-05 the RÉFÉRENCE RSUPTABYZ015 is requi	Noir		RKITYZ0NR0000	
			CR Rouge	Blanc-Noir		RKITYZ0BN0000	
			OEM 2021	OEM		RKITYZ0BL0000	
YZ	125-250	2006 > 2014	OEM 2013-2014	OEM		RKITYZ00EM504	€ 129,95
				Noir		RKITYZ0NR0504	
YZ	125-250	2015 > 2021	OEM 2015 > 2020	OEM		RKITYZ00EM515	€ 109,95
Garde-boue avant ventilé				Noir		RKITYZ0NR0515	€ 129,95
YZ	125-250	2022	OEM	OEM		RKITYZ0BL0022	€ 134,95
YZ-X	125	2020 > 2022	OEM 2015 > 2020	OEM		RKITYZ00EM515	€ 109,95
Garde-boue avant ventilé				Noir		RKITYZ0NR0515	€ 129,95
YZ-X	250	2016 > 2022	OEM 2015 > 2020	OEM		RKITYZ00EM515	€ 109,95
Garde-boue avant ventilé				Noir		RKITYZ0NR0515	€ 129,95
			OEM 2021	OEM		RKITYZ0BL0515	
YZF	250	2014 > 2018	OEM 2014 > 2017	OEM		RKITYZFBL0514	€ 149,95
Garde-boue avant ventilé				Blanc		RKITYZFBN0514	€ 149,95
				Noir		RKITYZFN0514	€ 149,95
				Y Yellow		RKITYZFGY0514	€ 149,95
				Y Yellow		RKITYZFGY0614	€ 259,95
			6 pieces	Jaune fluo		RKITYZFGF0614	€ 259,95
			6 pieces	OEM		RKITYZFBL0510	€ 109,95
YZF	250	2010 > 2013	OEM 2013	OEM		RKITYZFBN1611	€ 159,95
Garde-boue avant ventilé			OEM 2011 > 2013	Blanc		RKITYZFBN2611	
YZF	450	2010 > 2013	OEM 2011 > 2013	Blanc		RKITYZFOEM518	€ 149,95
Garde-boue avant ventilé				YZ Bleu-Blanc		RKITYZFBL0518	
YZF	250	2019 > 2022	OEM 2019-2020	YZ Bleu		RKITYZFN0518	
Garde-boue avant ventilé			OEM 2021-2022	Noir		RKITYZFN0518	
				Jaune fluo		RKITYZFGF0518	
			Édition limitée	Gris		RKITYZFGR0518	
	Kit 7 pcs	ac protec. F + couv. réservoir - OEM 2021-2022	OEM 2021-2022	YZ Bleu		RKITYZFBL0718	€ 172,95
YZ-FX	450	2019 > 2022	OEM 2019-2020	YZ Bleu-Blanc		RKITYZFOEM518	€ 149,95
Garde-boue avant ventilé			OEM 2021-2022	YZ Bleu		RKITYZFBL0518	
				Noir		RKITYZFN0518	
				Jaune fluo		RKITYZFGF0518	
			Édition limitée	Gris		RKITYZFGR0518	
	Kit 7 pcs	ac protec. F + couv. réservoir - OEM 2021-2022	OEM 2021-2022	YZ Bleu		RKITYZFBL0718	€ 172,95
YZF	450	2014 > 2017	OEM	YZ Bleu-Blanc		RKITYZFBL0514	€ 149,95
Garde-boue avant ventilé				Blanc-Noir		RKITYZFBN0514	
				Noir		RKITYZFN0514	
				Y Yellow		RKITYZFGY0514	
			6 pieces	Jaune fluo		RKITYZFGF0614	€ 259,95

MODEL	CC	ANNEE	NOTES	COULEUR	RÉFÉRENCE	PRIX	
YZF	450	2018 > 2022	OEM 2018 > 2020	YZ Bleu-Blanc		RKITYZFOEM518	€ 149,95
Garde-boue avant ventilé			OEM 2021-2022	YZ Bleu		RKITYZFBL0518	
				Noir		RKITYZFNRO518	
			Édition limitée	☀ Jaune fluo		RKITYZFGF0518	
				Gris		RKITYZFGRO518	
	Kit 7 pcs	ac protec. F + couv. réservoir - OEM 2021-2022		YZ Bleu		RKITYZFBL0718	€ 172,95
YZ-FX	250	2015 > 2019	OEM 2015 > 2017	YZ Bleu-Blanc		RKITWRF0EM515	€ 149,95
Garde-boue avant ventilé				Blanc-Noir		RKITWRFBN0515	
				Noir		RKITWRFNR0515	
YZ-FX	250	2020 > 2022	OEM 2020	YZ Bleu-Blanc		RKITYZF0EM518	€ 149,95
Garde-boue avant ventilé			OEM 2021-2022	YZ Bleu		RKITYZFBL0518	
				Noir		RKITYZFNRO518	
			Édition limitée	☀ Jaune fluo		RKITYZFGF0518	
				Gris		RKITYZFGRO518	
	Kit 7 pcs	ac protec. F + couv. réservoir - OEM 2021-2022		YZ Bleu		RKITYZFBL0718	€ 172,95
WRF	250	2007 > 2013	OEM 2007 > 2012	OEM		RKITWRF0EM403	€ 124,95
Garde-boue avant ventilé				Noir		RKITWRFNR0403	
WRF	250	2015 > 2019	OEM 2015 > 2017	OEM		RKITWRF0EM415	€ 129,95
Garde-boue avant ventilé				Blanc		RKITWRFBN0415	
				Noir		RKITWRFNR0415	
WRF	250	2015 > 2019	OEM 2015 > 2017	YZ Bleu-Blanc		RKITWRF0EM515	€ 149,95
Garde-boue avant ventilé				Noir		RKITWRFNR0515	
WRF	250	2020 > 2022	OEM 2020	YZ Bleu-Blanc		RKITWRF0EM419	€ 129,95
Garde-boue avant ventilé			OEM 2021-2022	YZ Bleu		RKITWRFBL0419	
				Blanc-Noir		RKITWRFBN0419	
				Y Yellow		RKITWRFY0419	
			Édition limitée	☀ Jaune fluo		RKITWRFY0419	
				Noir		RKITWRFNR0419	
WRF	450	2019 > 2022	OEM 2020	YZ Bleu-Blanc		RKITWRF0EM419	€ 129,95
Garde-boue avant ventilé			OEM 2021-2022	YZ Bleu		RKITWRFBL0419	
				Blanc-Noir		RKITWRFBN0419	
				Y Yellow		RKITWRFY0419	
			Édition limitée	☀ Jaune fluo		RKITWRFY0419	
				Noir		RKITWRFNR0419	
WRF	450	2007 > 2011	OEM	OEM		RKITWRF0EM403	€ 124,95
Garde-boue avant ventilé				Noir		RKITWRFNR0403	
WRF	450	2012 > 2015	OEM	OEM		RKITWRF0EM404	€ 124,95
Garde-boue avant ventilé				Noir		RKITWRFNR0404	
YZ-FX	450	2016 > 2018	OEM	OEM		RKITWRF0EM515	€ 149,95
Protec. Radiateur modèle(s) YZF 450 2014>2017 adaptable sur WRF 450 2016>2018							
Garde-boue avant ventilé							
WRF	450	2016 > 2018	OEM	YZ Bleu-Blanc		RKITWRF0EM415	€ 129,95
Protec. Radiateur modèle(s) YZF 450 2014>2017 adaptable sur WRF 250 2015>2019				Blanc-Noir		RKITWRFBN0415	
Garde-boue avant ventilé				Noir		RKITWRFNR0415	
WRF	450	2016 > 2018	OEM	YZ Bleu-Blanc		RKITWRF0EM515	€ 149,95
Garde-boue avant ventilé				Noir		RKITWRFNR0515	



PLASTIQUES RTECH

KAWASAKI

Protection de fourche

34,95 €
I.T.C.

 FLUO



RPSKXFVE0016



RPSKXFBN0016



















RPSKXFNR0016



RPSKXFVF0016

OEM Couleur d'orig. -  Fluo

MODEL	CC	ANNEE	NOTES	COULEUR	RÉFÉRENCE
KXF	250	2009 > 2016	OEM	Noir	 RPSKXFNR0009
KXF	250	2017 > 2022	OEM	Noir	 RPSKXFNR0016
				Blanc	 RPSKXFBN0016
				KX Green	 RPSKXFVE0016
				Neon Green	  RPSKXFVF0016
KXF	450	2009 > 2015	OEM	Noir	 RPSKXFNR0009
KXF	450	2016 > 2022	OEM	Noir	 RPSKXFNR0016
				Blanc	 RPSKXFBN0016
				KX Green	 RPSKXFVE0016
				Neon Green	  RPSKXFVF0016
KX-XC	250-450	2021-2022	OEM	Noir	 RPSKXFNR0016
				Blanc	 RPSKXFBN0016
				KX Green	 RPSKXFVE0016
				Neon Green	  RPSKXFVF0016

Bavette d'amortisseur

18,95 €
T.T.C.

OEM Couleur d'orig.

RPSPKXFNR016

MODEL	CC	ANNEE	NOTES	COULEUR	RÉFÉRENCE
KX	85-100	2014 > 2022	OEM	Noir	RPSPKX0NR014
KX	125-250	2003 > 2008	OEM	Noir	RPSPKX0NR000
KXF	250	2004 > 2016	OEM	Noir	RPSPKXFNR006
KXF	250	2017 > 2020	OEM	Noir	RPSPKXFNR016
KXF	250	2021-2022	OEM	Noir	RPSPKXFNR019
KXF	450	2004 > 2015	OEM	Noir	RPSPKXFNR006
KXF	450	2016 > 2018	OEM	Noir	RPSPKXFNR016
KXF	450	2019 > 2022	OEM	Noir	RPSPKXFNR019
KX-XC	250-450	2021-2022	OEM	Noir	RPSPKXFNR019
KLX R	450	2007 > 2016	OEM	Noir	RPSPKXFNR006

Guide chaîne

23,95 €
T.T.C.

OEM Couleur d'orig.

RCRUKXFNR006

MODEL	CC	ANNEE	NOTES	COULEUR	RÉFÉRENCE
KX	85-100	2000 > 2022	OEM	Noir	RCRUKX0NR014
KX	125-250	2003 > 2008	OEM	Noir	RCRUKXFNR004
KXF	250	2004 > 2005	OEM	Noir	RCRUKXFNR004
KXF	250-450	2006 > 2008	OEM	Noir	RCRUKXFNR006
KXF	250-450	2009 > 2022	OEM	Noir	RCRUKXFNR009
KX-XC	250-450	2021-2022	OEM	Noir	RCRUKXFNR009
KLXR	450	2007 > 2011	OEM	Noir	RCRUKXFNR006
KLXR	450	2012 > 2016	OEM	Noir	RCRUKXFNR009

GUIDE CHAÎNE MONOBLOCK R2.0 WORX
P. 2XX

Patin de bras oscillant

25,95 €
T.T.C.

RSLIKXFNR016

OEM Couleur d'orig.

MODEL	CC	ANNEE	NOTES	COULEUR	RÉFÉRENCE
KX	85-100	2000 > 2022	OEM	Noir	RSLIKX0NR014
KX	125-250	1994 > 2008	OEM	Noir	RSLIKX0NR003
KXF	250	2004-2005	OEM	Noir	RSLIKXFNR004
KXF	250-450	2006 > 2008	OEM	Noir	RSLIKXFNR006
KXF	250	2009 > 2016	OEM	Noir	RSLIKXFNR009
KXF	250	2017 > 2020	OEM	Noir	RSLIKXFNR016
KXF	250	2021-2022	OEM	Noir	RSLIKXFNR019
KXF	450	2009 > 2015	OEM	Noir	RSLIKXFNR009
KXF	450	2016 > 2018	OEM	Noir	RSLIKXFNR016
KXF	450	2019 > 2022	OEM	Noir	RSLIKXFNR019
KX-XC	250-450	2021-2022	OEM	Noir	RSLIKXFNR019
KLX R	450	2007 > 2016	OEM	Noir	RSLIKXFNR006

Grille de radiateur

36,95 €
T.T.C.

Protection totale de la partie inférieure du radiateur standard. Elle recouvre entièrement le plateau qui, dans la version standard, reste exposé aux chocs de la terre et de la pierre.



RGRKXFNR0019

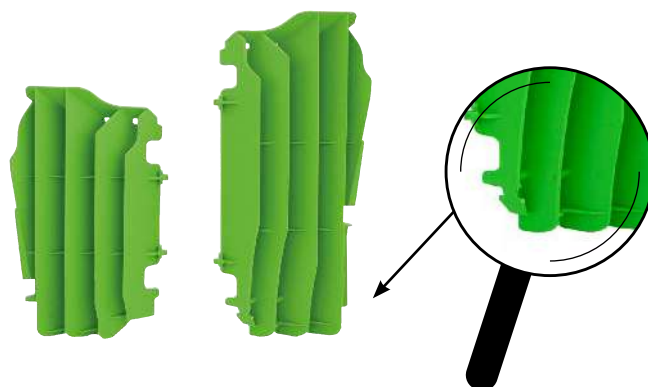

RGRKXFVE0019

OEM Couleur d'orig.

MODEL	CC	ANNEE	NOTES	COULEUR	RÉFÉRENCE
KXF	250	2021-2022	OEM	Noir	RGRKXFNR0019
KXF	250	2021-2022	OEM	KX Green	RGRKXFVE0019
KXF	450	2016 > 2022	OEM	Noir	RGRKXFNR0019
KXF	450	2016 > 2022	OEM	KX Green	RGRKXFVE0019
KX-XC	250-450	2021-2022	OEM	Noir	RGRKXFNR0019
KX-XC	250-450	2021-2022	OEM	KX Green	RGRKXFVE0019



Kits plastiques



ÉQUIPEMENT DE LA MOTO

OEM Couleur d'orig. - ☀️ Fluo

MODEL	CC	ANNEE	NOTES	COULEUR		RÉFÉRENCE	PRIX
KX	65	2001 > 2021	OEM 2020 > 2022 OEM 01 > 13 - 16 > 19	OEM	☀️	RKITKX0VE0508	€ 129,95
				OEM	☀️	RKITKX00EM508	
KX	85-100	2014 > 2021	OEM 2021 OEM 2020 OEM 2016 > 2019	OEM	☀️	RKITKX0VE0599	€ 129,95
				OEM	☀️	RKITKX0VE0598	
				OEM	☀️	RKITKX0VE0585	
				OEM	☀️	RKITKX00EM503	
KX	85-112	2022		OEM	☀️	RKITKX0VE0585	€ 129,95
KX	125-250	2003 > 2008		OEM	☀️	RKITKX00EM503	€ 129,95
KXF	250	2013 > 2016	OEM 2016	OEM	☀️	RKITKXFOEM596	€ 129,95
Garde-boue avant ventilé	250	2017 > 2020	OEM 2020 OEM 2019 OEM 2017-2018	Noir	☀️	RKITKXFNR0516	€ 129,95
				☀️ Neon Green	☀️	RKITKXFFV0516	€ 139,95
KXF	250	2017 > 2020	OEM 2020 OEM 2019 OEM 2017-2018	KX Green/Noir	☀️	RKITKXFE0519	€ 129,95
				OEM	☀️	RKITKXFOEM529	
Garde-boue avant ventilé	250	2021-2022	6 pcs OEM	OEM	☀️	RKITKXFOEM519	€ 129,95
				Blanc	☀️	RKITKXFBN0519	
KXF	250	2021-2022	with fork protector	Noir	☀️	RKITKXFNR0519	€ 129,95
				☀️ Neon Green	☀️	RKITKXFFV0519	€ 139,95
Garde-boue avant ventilé	250	2021-2022	OEM	OEM	☀️	RKITKXFFVE0599	€ 129,95
				KX Green/Blanc	☀️	RKITKXFOEM599	
KXF	450	2013 > 2015	with fork protector	Noir	☀️	RKITKXFNR0599	€ 129,95
				☀️ Neon Green	☀️	RKITKXFFV0599	€ 139,95
Garde-boue avant ventilé	450	2016 > 2018	OEM	OEM	☀️	RKITKXFFVE0699	€ 154,95
				Noir	☀️	RKITKXFOEM515	€ 129,95
KXF	450	2019 > 2022	OEM 2020-2021 OEM 2019	OEM	☀️	RKITKXFOEM517	€ 129,95
				Noir	☀️	RKITKXFNR0517	
Garde-boue avant ventilé	450	2016 > 2018	OEM	KX Green	☀️	RKITKXFE0517	€ 139,95
				☀️ Neon Green	☀️	RKITKXFFV0517	€ 139,95
KXF	450	2019 > 2022	OEM 2020-2021 OEM 2019	OEM	☀️	RKITKXFFVE0599	€ 129,95
				KX Green/Blanc	☀️	RKITKXFOEM599	
Garde-boue avant ventilé	450	2016 > 2018	OEM	Noir	☀️	RKITKXFNR0599	€ 129,95
				☀️ Neon Green	☀️	RKITKXFFV0599	€ 139,95
KX-XC	250-450	2021-2022	with fork protector OEM	OEM	☀️	RKITKXFFVE0699	€ 154,95
				KX Green/Blanc	☀️	RKITKXFOEM599	€ 129,95
Garde-boue avant ventilé	250-450	2021-2022	OEM	Noir	☀️	RKITKXFNR0599	€ 129,95
				☀️ Neon Green	☀️	RKITKXFFV0599	€ 139,95
Garde-boue avant ventilé	250-450	2021-2022	with fork protector	OEM	☀️	RKITKXFFVE0699	€ 154,95
				☀️ Neon Green	☀️	RKITKXFFV0599	€ 139,95

PLASTIQUES RTECH

SUZUKI

Couvercle de réservoir

38,95 €
T.T.C.



RCOVSRMZBL1



RCOVSRMZNR1



FLUO

RCOVSRMZGF1

OEM Couleur d'orig. - ☀ Fluo

MODEL	CC	ANNEE	NOTES	COULEUR	RÉFÉRENCE
RMZ	250	2019 > 2022	OEM	Bleu	RCOVSRMZBL1
				Jaune fluo ☀	RCOVSRMZGF1
				Noir	RCOVSRMZNR1
RMZ	450	2018 > 2022	OEM	Bleu	RCOVSRMZBL1
				Jaune fluo ☀	RCOVSRMZGF1
				Noir	RCOVSRMZNR1

Grille de radiateur

36,95 €
T.T.C.

Protection totale de la partie inférieure du radiateur standard. Elle recouvre entièrement le plateau qui, dans la version standard, reste exposé aux chocs de la terre et de la pierre.



RGRRMZGI0019

RGRRMZNR0019

OEM Couleur d'orig. - Fluo

MODEL	CC	ANNEE	NOTES	COULEUR	RÉFÉRENCE
RMZ	250	2019 > 2022	OEM	Noir	RGRRMZNR0019
				RM Yellow	RGRRMZGI0019
RMZ	450	2018 > 2022	OEM	Noir	RGRRMZNR0018
				RM Yellow	RGRRMZGI0018

Protection de fourche

36,95 €
T.T.C.

RPSRM0BN0007

RPSRM0GI0007

RPSRM0NR0007

OEM Couleur d'orig.

MODEL	CC	ANNEE	NOTES	COULEUR	RÉFÉRENCE	PRIX
RM	85	2000 > 2022	OEM 2016-2017 et 2020 > 2021	Noir	RPSRM0NR0085	€ 31,95
RM	125-250	2007 > 2011	OEM 2007 > 2011	Blanc	RPSRM0BN0007	€ 34,95
				Noir	RPSRM0NR0007	
				RM Yellow	RPSRM0GI0007	
RMZ	250	2004 > 2006	OEM	Blanc	RPSKX0BN0004	€ 34,95
				Noir	RPSKX0NR0004	
RMZ	450	2005-2006	OEM	Blanc	RPSRM0BN0004	€ 34,95
RMZ	250-450	2007 > 2022	OEM 2007 > 2011	Noir	RPSRM0NR0007	€ 34,95
			OEM 2012 > 2021	Blanc	RPSRM0BN0007	
				RM Yellow	RPSRM0GI0007	
RMXZ	450	2010 > 2019	OEM 2013 > 2019	Noir	RPSRM0NR0007	€ 34,95
			Sans guide câble compteur			
			OEM 2010 > 2012	Blanc	RPSRM0BN0007	
			Sans guide câble compteur			
			Sans guide câble compteur	RM Yellow	RPSRM0GI0007	

Bavette d'amortisseur

18,95 €
T.T.C.



RPSPRM0NR000

OEM Couleur d'orig.

MODEL	CC	ANNEE	NOTES	COULEUR	RÉFÉRENCE
RM	125-250	1996 > 2011	OEM	Noir	RPSPRM0NR000
RMZ	250	2004 > 2006	OEM	Noir	RPSPKXFNR006
RMZ	250	2007 > 2022	OEM	Noir	RPSPRM0NR000
RMZ	450	2005 > 2022	OEM	Noir	RPSPRM0NR000
RMXZ	450	2010 > 2019	OEM	Noir	RPSPRM0NR000

Guide chaîne

23,95 €
T.T.C.



RCRURMZN018

OEM Couleur d'orig.

MODEL	CC	ANNEE	NOTES	COULEUR	RÉFÉRENCE
RM	125-250	2005 > 2011	OEM	Noir	RCRURM0NR007
RMZ	250	2004 > 2006	OEM	Noir	RCRUKXFNR004
RMZ	250	2007 > 2018	OEM	Noir	RCRURM0NR007
RMZ	250	2019 > 2022	OEM	Noir	RCRURMZN018
RMZ	450	2005 > 2017	OEM	Noir	RCRURM0NR007
RMZ	450	2018 > 2022	OEM	Noir	RCRURMZN018
RMXZ	450	2010 > 2019	OEM	Noir	RCRURM0NR007

Patin de bras oscillant

25,95 €
T.T.C.



RSLIRMZNR018

OEM Couleur d'orig.

MODEL	CC	ANNEE	NOTES	COULEUR	RÉFÉRENCE
RM	125-250	2001 > 2011	OEM	Noir	RSLIRM0NR001
RMZ	250	2004 > 2006	OEM	Noir	RSLIKXFNR004
RMZ	250	2007 > 2009	OEM	Noir	RSLIRM0NR001
RMZ	250	2010 > 2018	OEM	Noir	RSLIRMZNR007
RMZ	250	2019 > 2022	OEM	Noir	RSLIRMZNR018
RMZ	450	2005-2006	OEM	Noir	RSLIRM0NR001
RMZ	450	2007	OEM	Noir	RSLIRMZNR007
RMZ	450	2008-2009	OEM	Noir	RSLIRM0NR001
RMZ	450	2010 > 2017	OEM	Noir	RSLIRMZNR007
RMZ	450	2018 > 2022	OEM	Noir	RSLIRMZNR018
RMXZ	450	2010 > 2019	OEM	Noir	RSLIRM0NR001

Kits plastiques



OEM Couleur d'orig. - ☀️ Fluo

MODEL	CC	ANNEE	NOTES	COULEUR	RÉFÉRENCE	PRIX
RM	85	2000 > 2022	OEM 2000 > 2015 et 2018 > 2022 OEM 2017 OEM 2016	OEM	RKITRM00EM510	€ 129,95
				OEM	RKITRM00EM599	
				OEM	RKITRM00EM590	
				OEM	RKITRM00EM501	€ 129,95
RM	125-250	1998 > 2000	OEM 2010-2011	OEM	RKITRM00EM502	€ 129,95
RMZ	250	2007 > 2009	OEM 2018 OEM 2017 OEM 2014-2016	OEM	RKITRMZOEM507	
RMZ	250	2010 > 2018	OEM 2018 OEM 2017 OEM 2014-2016	OEM	RKITRMZOEM592	€ 129,95
				OEM	RKITRMZOEM591	
				OEM	RKITRMZOEM511	
				Jaune fluo ☀️	RKITRMZGF0511	
				Noir	RKITRMZNR0511	
RMZ	250	2019 > 2022	OEM	Blanc	RKITRMZBN0511	
				OEM	RKITRMZOEM518	€ 129,95
Garde-boue avant ventilé				Jaune fluo ☀️	RKITRMZGF0518	
				RM Yellow	RKITRMZGI0518	
RMZ	450	2008 > 2017	OEM 2017 OEM 2014 > 16 - Yellow/Noir shrouds	OEM	RKITRMZOEM598	€ 129,95
				OEM	RKITRMZOEM508	
				Jaune fluo ☀️	RKITRMZGF0508	
				Noir	RKITRMZNR0508	
RMZ	450	2018 > 2022	OEM	OEM	RKITRMZOEM518	€ 129,95
				Jaune fluo ☀️	RKITRMZGF0518	
				RM Yellow	RKITRMZGI0518	
RMXZ	450	2010 > 2019	OEM 2017 OEM 2013 > 2016 OEM 2010 > 2012 et 2018-2019	OEM	RKITRMXOEM492	€ 124,95
				OEM	RKITRMXOEM491	
				OEM	RKITRMXOEM411	
				OEM		

PLASTIQUES RTECH

KTM

Plaque phare



RMASKKTMAR20



RMASKKTMBN20



RMASKKTMR20



RMASKKTMAN20



RMASKKTML17



FLUO
RMASKKTMGF17



RMASKKTMR17



RELASTNR0020

OEM Couleur d'orig. - Fluor

MODEL	CC	ANNEE	NOTES	COULEUR	RÉFÉRENCE	PRIX
EXC/EXCF XC-W/XCF-W	125 > 500	2017 > 2019	OEM 2017-2018 et Six Days 2019 OEM Six Days 2017 Édition limitée	K Orange	RMASKKTMAR17	€ 29,95
				Blanc	RMASKKTMBN17	
				Neon Orange	RMASKKTMAN17	
				Light Bleu	RMASKKTML17	
				Jaune fluo	RMASKKTMGF17	
Fluor	RMASKKTMR17					
EXC/EXCF XC-W/XCF-W	125 > 500	2020 > 2022	OEM OEM Six Days - Erzberg Rodeo 2020 Édition limitée	K Orange	RMASKKTMAR20	€ 29,95
				Blanc	RMASKKTMBN20	
				Neon Orange	RMASKKTMAN20	
				Light Bleu	RMASKKTML20	
				Noir	RMASKKTMR20	
EXC/EXCF XC-W/XCF-W	125 > 530	2000 > 2022	Élastiques de montage	Noir	RELASTNR0020	€ 10,95

Grille de radiateur

Protection totale de la partie supérieure et inférieure du radiateur de série. Elle couvre entièrement la partie qui reste sans protection avec le déflecteur standard. Elle évite également le contact avec le capot sur le dessus.

Nervures de renfort et structure en nid d'abeille pour une résistance accrue



RGRKTMNR0017

Cadre en technopolymer

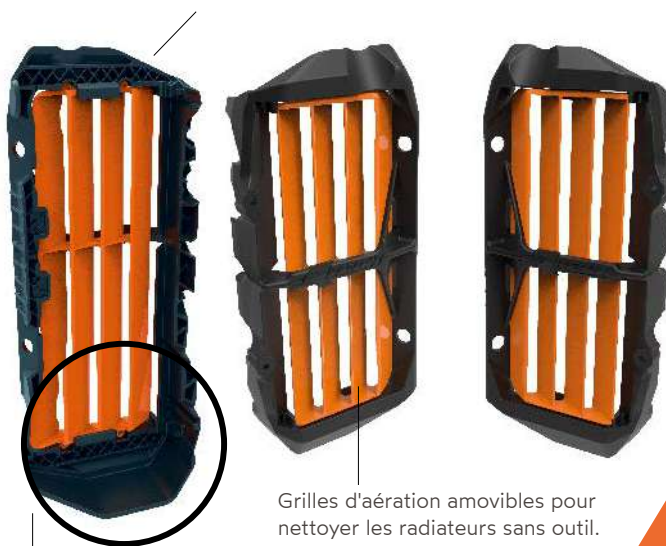

Grilles d'aération amovibles pour nettoyer les radiateurs sans outil.

Protection de radiateur inférieure horizontale. Empêche la collision entre le tuyau et le radiateur sur 250/300 2st.

RGRKTMAR0019

OEM Couleur d'orig. - ☀️ Fluo

MODEL	CC	ANNEE	NOTES	COULEUR	RÉFÉRENCE	PRIX
SX	125-150	2016 > 2018	OEM - Original radiator	Noir	RGRKTMNR0017	€ 41,95
			Original radiator	K Orange	RGRKTMAR0017	
			Original radiator	Blanc	RGRKTMBN0017	
			Original radiator	Jaune fluo	RGRKTMGF0017	
SX	250	2017-2018	OEM - Original radiator	Noir	RGRKTMNR0017	€ 41,95
			Original radiator	K Orange	RGRKTMAR0017	
			Original radiator	Blanc	RGRKTMBN0017	
			Original radiator	Jaune fluo	RGRKTMGF0017	
SXF	250-350-450	2016 > 2018	OEM - Original radiator	Noir	RGRKTMNR0017	€ 41,95
			Original radiator	K Orange	RGRKTMAR0017	
			Original radiator	Blanc	RGRKTMBN0017	
			Original radiator	Jaune fluo	RGRKTMGF0017	
EXC/EXCF XC-W/XCF-W	125 > 500	2017 > 2019	OEM - Original radiator	Noir	RGRKTMNR0017	€ 41,95
			Original radiator	K Orange	RGRKTMAR0017	
			Original radiator	Blanc	RGRKTMBN0017	
			Original radiator	Jaune fluo	RGRKTMGF0017	
XC / XC-F	250-300-350-450	2017-2018	OEM - Original radiator	Noir	RGRKTMNR0017	€ 41,95
			Original radiator	K Orange	RGRKTMAR0017	
			Original radiator	Blanc	RGRKTMBN0017	
			Original radiator	Jaune fluo	RGRKTMGF0017	
XC/ XC-F	250-300-350-450	2019 > 2022	OEM - Original radiator	Noir	RGRKTMNR0019	€ 43,95
			Original radiator	K Orange	RGRKTMAR0019	
			Original radiator	Jaune fluo	RGRKTMGF0019	
			Original radiator	Jaune fluo	RGRKTMGF0019	
SXF	450 Factory Edition	2018 > 2022	OEM - Original radiator	Noir	RGRKTMNR0019	€ 43,95
			Original radiator	K Orange	RGRKTMAR0019	
			Original radiator	Jaune fluo	RGRKTMGF0019	
			Original radiator	Jaune fluo	RGRKTMGF0019	
SX/SXF	125 > 450	2019 > 2022	OEM - Original radiator	Noir	RGRKTMNR0019	€ 43,95
			Original radiator	K Orange	RGRKTMAR0019	
			Original radiator	Jaune fluo	RGRKTMGF0019	
			Original radiator	Jaune fluo	RGRKTMGF0019	
EXC/EXCF XC-W/XCF-W	150 > 500	2020 > 2022	OEM - Original radiator	Noir	RGRKTMNR0019	€ 43,95
			Original radiator	K Orange	RGRKTMAR0019	
			Original radiator	Jaune fluo	RGRKTMGF0019	
			Original radiator	Jaune fluo	RGRKTMGF0019	

Protection de fourche



RPSKTMAR0016



RPSKTMCL0016



RPSKTMAN0016



FLUO



RPSKTMGF0016

OEM Couleur d'orig. - ☀ Fluo

MODEL	CC	ANNEE	NOTES	COULEUR	RÉFÉRENCE	PRIX	
SX	65	2019 > 2022	OEM	Blanc	RPSKTMBN1965	€ 29,95	
				Noir			RPSKTMNR1965
				K Orange			RPSKTMAR1965
SX	85	2009 > 2017	OEM 2011 > 17 - adaptable 2003 > 17 OEM 2003 > 06 - adaptable 2003 > 17 OEM 2007 > 10 - adaptable 2003 > 17	Blanc	RPSKTMBN0985	€ 31,95	
				Noir			RPSKTMNR0985
				K Orange			RPSKTMAR0985
SX	85	2018 > 2022	OEM	Blanc	RPSKTMBN0185	€ 31,95	
				Noir			RPSKTMNR0185
				K Orange			RPSKTMAR0185
SX	125-144-150-250	2008 > 2014	OEM 2010 > 2014 - 2011 > 15 OEM - 2008-2009 - 2010 OEM 2008-2009	Blanc	RPSKTMBN0008	€ 34,95	
				Noir			RPSKTMNR0008
				K Orange			RPSKTMAR0008
SXF	250-350-450-505	2008 > 2014	OEM 2010 > 2014 - 2011 > 15 OEM - 2008-2009 - 2010 OEM 2008-2009	Blanc	RPSKTMBN0008	€ 34,95	
				Noir			RPSKTMNR0008
				K Orange			RPSKTMAR0008
SX	125-150-250	2015 > 2022	OEM 2015-2016 et 2018 > 2020 et 2022 OEM 2017	Blanc	RPSKTMBN0020	€ 34,95	
				K Orange			RPSKTMAR0016
				Jaune fluo			RPSKTMGF0015
				Neon Orange			RPSKTMAN0016
				Light Bleu			RPSKTMCL0016
				Noir			RPSKTMNR0015
SXF	250-350-450	2015 > 2022	OEM 2021 OEM 2017 OEM 2015-2016 et 2018 > 2020 et 2022	K Orange	RPSKTMAR0016	€ 34,95	
				Blanc			RPSKTMBN0020
				Jaune fluo			RPSKTMGF0015
				Neon Orange			RPSKTMAN0016
				Light Bleu			RPSKTMCL0016
				Noir			RPSKTMNR0015
SXF	450 Factory Edition	2018 > 2022	OEM	K Orange	RPSKTMAR0016	€ 34,95	
				Blanc			RPSKTMBN0020
				Jaune fluo			RPSKTMGF0015
				Neon Orange			RPSKTMAN0016
				Light Bleu			RPSKTMCL0016
				Noir			RPSKTMNR0015
EXC / EXCF	125-200-250-250F-300-350F-400-450-500-530	2008 > 2015	OEM 2021 OEM 2010 > 14 - 2011 > 15 OEM - 2008-2009, 2010 OEM - 2008-2009	Blanc	RPSKTMBN0008	€ 34,95	
				Noir			RPSKTMNR0008
				K Orange			RPSKTMAR0008
				Noir			RPSKTMNR0015
EXC / EXCF	250 > 500	2016 > 2022	OEM 18 > 21 - Six Days 19-20 - Erzberg Rodeo 20-21 OEM 2016 OEM 2017 - Six Days 2017-18 et 2021	Blanc 2020	RPSKTMBN0020	€ 34,95	
				K Orange			RPSKTMAR0016
				Jaune fluo			RPSKTMGF0015
				Neon Orange			RPSKTMAN0016
				Light Bleu			RPSKTMCL0016
				Noir			RPSKTMNR0015
XC-F / XC XC-W / XCF-W	125-150-250-300 350-450	2017 > 2022	OEM 2018 > 2020 OEM 2017	Blanc 2020	RPSKTMBN0020	€ 34,95	
				Jaune fluo			RPSKTMGF0015
				Neon Orange			RPSKTMAN0016
				K Orange			RPSKTMAR0016
				Light Bleu			RPSKTMCL0016
				Noir			RPSKTMNR0015

Bavette d'amortisseur



RPSPKTMAR016



RPSPKTMNR016

OEM Couleur d'orig.

MODEL	CC	ANNEE	NOTES	COULEUR	RÉFÉRENCE	PRIX
SX	65	2016 > 2022	OEM	Noir	RPSPKTMNR165	€ 18,95
SX	85	2003 > 2012	OEM	Noir	RPSPKTMNR085	€ 14,95
SX	85	2013 > 2017	OEM	Noir	RPSPKTMNR985	€ 14,95
SX	85	2018 > 2022	OEM	Noir	RPSPKTMNR185	€ 14,95
SX	125-200-250-400-450-520-525	1998 > 2006	OEM	Noir	RPSPKTMNR000	€ 14,95
SX	125-144-150	2007 > 2015	OEM	Noir	RPSPKTMNR007	€ 14,95
SX	250	2007 > 2016	OEM	K Orange	RPSPKTMAR007	
SX	250	2017 > 2022	OEM	Noir	RPSPKTMNR007	€ 14,95
SXF	250-350-450	2007 > 2015	OEM	K Orange	RPSPKTMAR007	
SX / SXF	125-150-250F-350F-450F	2016 > 2022	OEM	Noir	RPSPKTMNR016	€ 14,95
EXC / EXCF	125-200-250-250F-300-400-520-525	1998 > 2007	OEM	Noir	RPSPKTMNR000	€ 14,95
EXC / EXCF	125-200-250-250F-300-350F-400-500-530	2008 > 2016	OEM	Noir	RPSPKTMNR007	€ 14,95
EXC / EXCF	250 > 500	2017 > 2022	OEM	K Orange	RPSPKTMAR007	
EXC / EXCF	250 > 500	2017 > 2022	OEM	Noir	RPSPKTMNR016	€ 14,95
XC-W/-XCF-W	125 > 300	2017 > 2022	OEM	K Orange	RPSPKTMAR016	
XC/XC-F	125-150-250-300-350-450	2017 > 2022	OEM	Noir	RPSPKTMNR016	€ 14,95
XC/XC-F	125-150-250-300-350-450	2017 > 2022	OEM	K Orange	RPSPKTMAR016	
XC/XC-F	125-150-250-300-350-450	2017 > 2022	OEM	Noir	RPSPKTMNR016	€ 14,95
XC/XC-F	125-150-250-300-350-450	2017 > 2022	OEM	K Orange	RPSPKTMAR016	

Guide chaîne



RCRUKTMNRAR7



RCRUKTMNRN7

MODEL	CC	ANNEE	NOTES	COULEUR	RÉFÉRENCE	PRIX
SX	65	2016 > 2022	OEM	Noir	RCRUKTMNR165	€ 23,95
SX	85	2004 > 2014	OEM	Noir	RCRUKTMNR000	€ 23,95
SX	85	2015 > 2022	OEM - Bi-Material	NoirNeutral	RCRUKTMNRNT14	€ 38,95
SX / SXF	125-200-250-400-450-520	1994 > 2006	OEM	NoirRK Orange	RCRUKTMNRAR14	
SX	125-144-150-250	2007	OEM - Bi-Material	Noir	RCRUKTMNR000	€ 23,95
SXF	250-450-505	2007	OEM - Bi-Material	NoirNeutral	RCRUKTMNRNT7	€ 38,95
SXF	250-450-505	2007	OEM - Bi-Material	NoirRK Orange	RCRUKTMNRAR7	
SX / SXF	125-150-250-350-450	2008 > 2022	OEM - Alloy reinforced	NoirNeutral	RCRUKTMNRNT7	€ 38,95
SX / SXF	125-150-250-350-450	2008 > 2022	OEM - Alloy reinforced	NoirRK Orange	RCRUKTMNRAR7	
EXC	125-200-250-300-400-	1994 > 2007	OEM	Noir	RCRUKTMNR000	€ 23,95
EXC / EXCF	125-150-250-350-450-	2008 > 2013	OEM - Bi-Material	NoirNeutral	RCRUKTMNRNT7	€ 38,95
EXC / EXCF	125-150-250-350-450-500	2014 > 2022	OEM - Bi-Material	NoirRK Orange	RCRUKTMNRAR7	
EXC / EXCF	125-150-250-350-450-500	2014 > 2022	OEM - Bi-Material	NoirNeutral	RCRUKTMNRNT14	€ 38,95
EXC / EXCF	125-150-250-350-450-500	2014 > 2022	OEM - Bi-Material	NoirRK Orange	RCRUKTMNRAR14	
XC-W	125-150-250-300	2014 > 2022	OEM - Bi-Material	NoirNeutral	RCRUKTMNRNT14	€ 38,95
XC-W	125-150-250-300	2014 > 2022	OEM - Bi-Material	NoirRK Orange	RCRUKTMNRAR14	
XC/XC-F	125-150-250-300-350-450	2008 > 2022	OEM - Alloy reinforced	Noir	RCRUKTMNR016	€ 38,95
XC/XC-F	125-150-250-300-350-450	2008 > 2022	OEM - Alloy reinforced	Noir	RCRUKTMNR016	€ 38,95



GUIDE CHAÎNE MONOBLOCK R2.0 WORX
P. 2XX

Patin de bras oscillant

25,95 €
T.T.C.



RSLIKTMNR012

MODEL	CC	ANNEE	NOTES	COULEUR	RÉFÉRENCE
SX	65	2016 > 2022	OEM	Noir	RSLIKTMNR165
SX	85	2003 > 2014	OEM	Noir	RSLIKTMNR085
SX	85	2015 > 2022	OEM	Noir	RSLIKTMNR185
SX / SXF	125-200-250-400-450-	1997 > 2006	OEM	Noir	RSLIKTMNR000
SX	125-144-150-250	2007 > 2010	OEM	Noir	RSLIKTMNR007
SXF	250-450-505-525	2007 > 2010	OEM	Noir	RSLIKTMNR007
SX / SXF	125-150-250-250F-350F-	2011 > 2022	OEM	Noir	RSLIKTMNR011
EXC	125-200-250-250F-300-	1997 > 2007	OEM	Noir	RSLIKTMNR000
EXC / EXCF	125-150-250-350-450-	2008 > 2011	OEM	Noir	RSLIKTMNR007
EXC / EXCF	125-200-250-250F-300-	2011 > 2022	OEM	Noir	RSLIKTMNR012
XC-W/XCF-W	125 > 300	2011 > 2022	OEM	Noir	RSLIKTMNR012
XC / XC-F	125-150-250-300-350-450	2017 > 2022	OEM	Noir	RSLIKTMNR011

Patin chaîne

9,95 €
T.T.C.



RPATTKTMNR16

MODEL	CC	ANNEE	NOTES	COULEUR	RÉFÉRENCE
SX / SXF	125-144-150-200-250-250F-400-450-	2000 > 2010	OEM	Noir	RPATTKTMNR01
SX	125	2012 > 2015	OEM	Noir	RPATTKTMNR11
SX	125-150	2016 > 2022	OEM	Noir	RPATTKTMNR16
SX	250	2012 > 2016	OEM	Noir	RPATTKTMNR11
SX	250	2017 > 2022	OEM	Noir	RPATTKTMNR16
SXF	250-350-450	2012 > 2015	OEM	Noir	RPATTKTMNR11
SXF	250-350-450	2016 > 2022	OEM	Noir	RPATTKTMNR16
EXC / EXCF	125-200-250-250F-300-	2000 > 2011	OEM	Noir	RPATTKTMNR01
EXC / EXCF	125-200-250-250F-300-	2012 > 2022	OEM	Noir	RPATTKTMNR11
XC-W/XCF-W	125 > 300	2012 > 2022	OEM	Noir	RPATTKTMNR11
XC / XC-F	250-300-350-450	2017 > 2022	OEM	Noir	RPATTKTMNR16

Kits plastiques



RKITKTMOEM599

MODEL	CC	ANNEE	NOTES	COULEUR	RÉFÉRENCE	PRIX	
SX	65	2012 > 2015	OEM 2013 > 15	OEM Blanc Noir		RKITKTMOEM511 RKITKTMNB0511 RKITKTMNR0511	€ 129,95
SX	65	2016 > 2022	OEM 2019 > 2021 Orange/Blanc OEM 2017 OEM 2016 et 2018	OEM OEM Blanc Noir Orange		RKITKTM019500 RKITKTM017500 RKITKTM016500 RKITKTMNB0500 RKITKTMNR0500 RKITKTMAR0500	€ 129,95
SX	85	2006 > 2012	adaptable from 2003 adaptable from 2003	Blanc Noir		RKITKTMNB0507 RKITKTMNR0507	€ 129,95
SX	85	2013 > 2017	OEM 2017 - Left air box cover included OEM 2016 - Left air box cover included OEM 2015 - Left air box cover included Left air box cover included Left air box cover included	OEM OEM OEM Blanc Noir		RKITKTMOEM533 RKITKTMOEM523 RKITKTMOEM593 RKITKTMNB0513 RKITKTMNR0513	€ 129,95
SX	85	2018 > 2022	OEM 2018 OEM 2019 > 2022	OEM OEM K Orange Blanc Noir		RKITKTMOEM185 RKITKTMOEM285 RKITKTMAR0185 RKITKTMNB0185 RKITKTMNR0185	€ 139,95
SX	125-150	2013 > 2015	With Light Bleu Fork protectors OEM 2016 - Air box covers includes OEM 2015 - Air box covers includes OEM 2013-14 Air box covers includes Air box covers includes Air box covers includes	Light Bleu-K Orange OEM OEM OEM Blanc-Noir Noir		RKITKTMAN0185 RKITKTMCL0185	€ 149,95
SX	125-150-250	2019 > 2022	OEM 2019-2020-2022 OEM 2021	OEM OEM Blanc Noir K Orange		RKITKTMOEM594 RKITKTMOEM592 RKITKTMOEM512 RKITKTMNB0512 RKITKTMNR0512	€ 129,95
SX	250	2013 > 2016	Édition limitée OEM 2016 - Air box covers includes OEM 2015 - Air box covers includes OEM 2013-14 Air box covers includes Air box covers includes	Light Bleu-K Orange Gris OEM OEM OEM Noir		RKITKTMAN0185 RKITKTMCL0599 RKITKTMGR0599 RKITKTMOEM594 RKITKTMOEM592 RKITKTMNB0512 RKITKTMNR0512	€ 149,95 € 159,95 € 149,95

MODEL	CC	ANNEE	NOTES	COULEUR	RÉFÉRENCE	PRIX					
SX Garde-boue avant ventilé	250	2017-2018	OEM 2018 OEM 2017	OEM	RKITKTMOEM536	€ 149,95					
				OEM	RKITKTMOEM526						
				Orange-Blanc	RKITKTMOEM516						
				Blanc-Noir	RKITKTMBN0516						
				Noir	RKITKTMNR0516						
				☀ Jaune fluo	RKITKTMGF0516						
				☀ Neon Orange	RKITKTMAN0516						
				FULL ORANGE Factory Edition	RKITKTMUS1516						
				K Orange	RKITKTMGR0516						
				Gris	RKITKTMGR0516						
				☀ Light Bleu-K Orange	RKITKTMCL0518		€ 164,95				
				With Light Bleu Fork protectors							
SX Garde-boue avant ventilé	125-150	2016 > 2018	OEM 2018 OEM 2017 OEM 2016	OEM	RKITKTMOEM536	€ 149,95					
				OEM	RKITKTMOEM526						
				OEM	RKITKTMOEM516						
				Blanc-Noir	RKITKTMBN0516						
				Noir	RKITKTMNR0516						
				☀ Jaune fluo	RKITKTMGF0516						
				Orange	RKITKTMUS1516						
				Gris	RKITKTMGR0516						
				☀ Neon Orange	RKITKTMAN0516						
				☀ Light Bleu-K Orange	RKITKTMCL0518		€ 164,95				
				With Light Bleu Fork protectors							
				SXF Garde-boue avant ventilé	250-350-450		2013 > 2015	With Light Bleu Fork protectors	OEM 2016 - Air box covers includes	RKITKTMOEM594	€ 129,95
OEM 2015 - Air box covers includes	OEM	RKITKTMOEM592									
OEM 2013-2014 - Air box covers includes	OEM	RKITKTMOEM512									
Air box covers includes	Noir	RKITKTMNR0512									
SXF Garde-boue avant ventilé	250-350-450	2016 > 2018	OEM 2018 OEM 2017 OEM 2016	OEM	RKITKTMOEM536	€ 149,95					
				OEM	RKITKTMOEM526						
				OEM	RKITKTMOEM516						
				Blanc-Noir	RKITKTMBN0516						
				Noir	RKITKTMNR0516						
				☀ Jaune fluo	RKITKTMGF0516						
				Orange	RKITKTMUS1516						
				Gris	RKITKTMGR0516						
				☀ Neon Orange	RKITKTMAN0516						
				☀ Light Bleu-K Orange	RKITKTMCL0518		€ 164,95				
				With Light Bleu Fork protectors							
				SXF	250-350-450		2019 > 2022	OEM 2019-2020 OEM 2021	OEM	RKITKTMOEM599	€ 149,95
OEM	RKITKTMOEM600										
Blanc	RKITKTMBN0599										
Noir	RKITKTMNR0599										
K Orange	RKITKTMAR0599										
☀ Neon Orange	RKITKTMAN0599										
Orange Light Bleu	RKITKTMCL0599										
Gris	RKITKTMGR0599										
SXF	450 Factory Edition	2018 > 2022	2018 Factory Edition OEM 2021			OEM			RKITKTMOEM599	€ 149,95	
						OEM			RKITKTMOEM600		
						Blanc			RKITKTMBN0599		
						Noir			RKITKTMNR0599		
				K Orange	RKITKTMAR0599						
				☀ Neon Orange	RKITKTMAN0599						
				☀ Light Bleu-K Orange	RKITKTMCL0599						
				Gris	RKITKTMGR0599						
				XC / XC-F Garde-boue avant ventilé	250-300-350-450	2017-2018	OEM 2018 OEM 2017	OEM	RKITKTMOEM536		€ 149,95
								OEM	RKITKTMOEM526		
								Orange-Blanc	RKITKTMOEM516		
								Blanc-Noir	RKITKTMBN0516		
Noir	RKITKTMNR0516										
☀ Jaune fluo	RKITKTMGF0516										
☀ Neon Orange	RKITKTMAN0516										
Full Orange Factory Edition	RKITKTMUS1516										
K Orange	RKITKTMGR0516										
Gris	RKITKTMGR0516										
☀ Light Bleu-K Orange	RKITKTMCL0518	€ 164,95									
With Light Blue Fork protectors											
XC / XC-F	250-300-350-450	2019 > 2022	OEM 2019-2020 OEM 2021	OEM	RKITKTMOEM599	€ 149,95					
				OEM	RKITKTMOEM600						
				Blanc	RKITKTMBN0599						
				Noir	RKITKTMNR0599						
				K Orange	RKITKTMAR0599						
				☀ Neon Orange	RKITKTMAN0599						
				☀ Light Bleu-K Orange	RKITKTMCL0599						
				Gris	RKITKTMGR0599						
				EXC / EXCF	125-200-250-300-350-450-500		2014 > 2016	OEM 2015-16 Air box covers includes	OEM	RKITKTMOEM495	€ 124,95
								OEM 2014 Air box covers includes	OEM	RKITKTMOEM415	
								OEM Six Days 2014-2015	OEM Six Days	RKITKTMBN0415	
								Air box covers includes	Noir	RKITKTMNR0415	
Air box covers includes	☀ Neon Orange	RKITKTMAN0415									

MODEL	CC	ANNEE	NOTES	COULEUR	RÉFÉRENCE	PRIX		
EXC/EXCF/XC-W	125-150-250-300-350-450-500	2017 > 2019	OEM 2017 et 2019 - with left airbox side panel	OEM		RKITKTMOEM417	€ 139,95	
			OEM Six Days 2018 - with left airbox side panel with left airbox side panel	OEM Six Days		RKITKTMBN0417		
			OEM 2018 - with left airbox side panel	OEM		RKITKTMNR0417		
			OEM Six Days 2019 - with left airbox side panel with left airbox side panel	OEM Six Days		RKITKTMOEM418		
			OEM Six Days 2019 - with left airbox side panel with left airbox side panel	OEM Six Days		RKITKTMOEM488		€ 149,95
			OEM Six Days 2017 - with left airbox side panel with left airbox side panel	☀: Neon Orange		RKITKTMAR0517		
			OEM Six Days 2017 - with left airbox side panel with left airbox side panel	OEM Six Days		RKITKTMAN0517		
			OEM 2018 - with left airbox side panel with left airbox side panel	Noir		RKITKTMBN0517		
			OEM 2018 - with left airbox side panel with left airbox side panel	OEM		RKITKTMNR0517		
			OEM 2018 - with left airbox side panel with left airbox side panel	☀: Jaune fluo		RKITKTMOEM517		
			OEM 2018 - with left airbox side panel with left airbox side panel	Gris		RKITKTMGF0517		
			OEM Six Days 2019 - with left airbox side panel	OEM Six Days		RKITKTMG0517		
			OEM 2018 - with left airbox side panel With Light Blue Fork protectors	OEM Six Days		RKITKTMOEM588		
	Light Bleu-K Orange	RKITKTMOEM518	€ 164,95					
		RKITKTMCLO528						
EXC / EXCF XC-W/XCF-W	125-150-250-300-350-450-500	2020 > 2022	OEM 2020 - with left airbox side panel with left airbox side panel	K Orange-Noir		RKITKTMOEM420	€ 139,95	
			OEM - with left airbox side panel with left airbox side panel	K Orange		RKITKTMAR0420		
			OEM 2021 - with left airbox side panel with left airbox side panel	Blanc		RKITKTMBN0420		
			OEM 2022 - with left airbox side panel with left airbox side panel	Noir		RKITKTMNR0420		
			OEM 2020 - with left airbox side panel with left airbox side panel	K Orange-Grey		RKITKTMOEM421		€ 147,95
			OEM 2020 - with left airbox side panel with left airbox side panel	K Orange-Bleu		RKITKTMOEM423		€ 147,95
			OEM Six Days 2021 - with left airbox side panel with left airbox side panel	K Orange-Noir		RKITKTMOEM520		€ 149,95
			OEM Six Days 2021 - with left airbox side panel with left airbox side panel	Blanc		RKITKTMBN0520		
			OEM Six Days 2021 - with left airbox side panel with left airbox side panel	Noir		RKITKTMNR0520		
			OEM Six Days 2021 - with left airbox side panel with left airbox side panel	K Orange		RKITKTMAR0520		
			OEM Six Days 2021 - with left airbox side panel with left airbox side panel	☀: Neon Orange		RKITKTMAN0520		
			OEM Six Days 2021 - with left airbox side panel with left airbox side panel	☀: Jaune fluo		RKITKTMGF0520		
			OEM 2021 - with left airbox side panel with left airbox side panel	K Orange/Light Bleu		RKITKTMCLO520		
OEM 2021 - with left airbox side panel with left airbox side panel	Gris	RKITKTMG0520						
OEM 2021 - with left airbox side panel with left airbox side panel	K Orange-Grey	RKITKTMOEM521	€ 159,95					
OEM 2022 - with left airbox side panel	K Orange-Bleu	RKITKTMOEM623	€ 159,95					



PLASTIQUES RTECH

HUSABERG

Kits plastiques

122,95 €
T.T.C.



MOD	CC	ANNEE	NOTES	COULEUR	RÉFÉRENCE	
TE / FE	125-250-300-350- 450-501	2013-2014	OEM 2014	OEM Blanc Noir		RKITHBGOEM400 RKITHBGBN0400 RKITHBGNR0400

Protection de fourche

34,95 €
T.T.C.

RPSKTMAR008

MODEL	CC	ANNEE	NOTES	COULEUR	RÉFÉRENCE
TE	125	2012 > 2014	OEM	HBG Bleu	RPSKTMAR008
TE	250-300	2011 > 2014	OEM	HBG Bleu	RPSKTMAR008
FE/FS/FC/FX	250-350-400-450-501-650	2009 > 2014	OEM 2011 > 2014	HBG Bleu	RPSKTMAR008

Bavette d'amortisseur

14,95 €
T.T.C.

RPSPKTMNR007

MODEL	CC	ANNEE	NOTES	COULEUR	RÉFÉRENCE
TE	125-250-300	2011 > 2014		Noir	RPSPKTMNR007
FE	250-350-450-501	2013-2014		Noir	RPSPKTMNR007

Guide chaîne

38,95 €
T.T.C.

RCRUKTMNRNT7

MODEL	CC	ANNEE	NOTES	COULEUR	RÉFÉRENCE
FE / FS / FX	350-400-450-500-650	2009 > 2014	OEM - Bi-Material	NoirNeutral	RCRUKTMNRNT7
TE	125	2012 > 2014	OEM - Bi-Material	NoirNeutral	RCRUKTMNRNT7
TE	250-300	2011 > 2014	OEM - Bi-Material	NoirNeutral	RCRUKTMNRNT7

Patin de bras oscillant

25,95 €
T.T.C.

RSLIKTMNR007

MODEL	CC	ANNEE	NOTES	COULEUR	RÉFÉRENCE
FE / FS / FX	All models	2009 > 2012	OEM	Noir	RSLIKTMNR007
TE	250-300	2011-2012	OEM	Noir	RSLIKTMNR007
TE / FE	125-250-300-350-450-501	2013-2014	OEM	Noir	RSLIKTMNR012

Patin chaîne

9,95 €
T.T.C.

MODEL	CC	ANNEE	NOTES	COULEUR	RÉFÉRENCE
FE / FS / FX	All models	2009 > 2012	OEM	Noir	RPATTKTMR01
TE	250-300	2011-2012	OEM	Noir	RPATTKTMR01
TE / FE	125-250-350-450-501	2013-2014	OEM	Noir	RPATTKTMR11

PLASTIQUES RTECH

HUSQVARNA

Protection de fourche



OEM Couleur d'orig. - ☀ Fluo

MODEL	CC	ANNEE	NOTES	COULEUR	RÉFÉRENCE	PRIX
TC	65	2017 > 2022	OEM - Fits on model 2017-18	HSQ Yellow Noir	RPSKTMGQ1965 RPSKTMNR1965	€ 29,95
				Jaune fluo ☀	RPSKTMGF1965	
TC	85	2014>2017	OEM 2014 > 2016	HSQ Yellow Blanc Noir	RPSKTMGQ0985 RPSKTMBN0985 RPSKTMNR0985	€ 31,95
TC	85	2018 > 2022	OEM	HSQ Yellow Blanc Noir	RPSKTMGQ0185 RPSKTMBN0185 RPSKTMNR0185	€ 31,95
CR / WR	125-250-300	2008 > 2013	OEM Marzocchi 50	Noir Blanc	RPSHSQNR0011 RPSHSQB0011	€ 38,95
TC/TE/SMRR	250-310-450-510-530	2008 > 2013	OEM Marzocchi 50	Noir	RPSHSQNR0011	€ 38,95
TC	250	2007 > 2013	OEM Marzocchi 50	Noir	RPSHSQNR0011	€ 38,95
TC / FC	125-250-350-450	2014	OEM	HSQ Yellow Blanc Noir	RPSKTMGQ0008 RPSKTMBN0008 RPSKTMNR0008	€ 34,95
TE / FE	125-250-300-350-450-501	2014-2015	OEM	HSQ Yellow Blanc Noir	RPSKTMGQ0008 RPSKTMBN0008 RPSKTMNR0008	€ 34,95
TC / FC	125-250-350-450	2015	OEM	HSQ Yellow Noir	RPSKTMGQ0015 RPSKTMNR0015	€ 34,95
TC/FC/TE/FE TX / FX	125-150-250-300-350-450-501	2016 > 2022	OEM 2017 et 2022	HSQ Bleu Blanc 2020 Noir	RPSHSQBLH016 RPSHSQB00020 RPSHSQNR0016	€ 34,95

Plaque phare



FLUO

RMASKHSQNR17

RMASKHSQBN17

RMASKHSQGF17

OEM Couleur d'orig. - ☀ Fluo

MODEL	CC	ANNEE	NOTES	COULEUR	RÉFÉRENCE	PRIX
TX	125	2017 > 2019	OEM	Blanc	RMASKHSQBN17	€ 29,95
				Noir	RMASKHSQNR17	
				Jaune fluo	RMASKHSQGF17	
TE / FE	150-250-300-350-450-501	2017 > 2019	OEM	Gris	RMASKHSQGR17	€ 29,95
				Blanc	RMASKHSQBN17	
				Noir	RMASKHSQNR17	
TE / FE	150-250-300-350-450-501	2020 > 2022	OEM	Jaune fluo	RMASKHSQGF17	€ 29,95
				Gris	RMASKHSQGR17	
				Blanc	RMASKHSQBN20	
TE / FE	150-250-300-350-450-501	2020 > 2022	OEM	Noir	RMASKHSQNR20	€ 29,95
				Jaune fluo	RMASKHSQGF20	
				Gris	RMASKHSQGR20	
TE / FE	150-250-300-350-450-501	2020 > 2022	Édition limitée Headlight Bracket Headlight Bracket Headlight Bracket	HSQ Yellow	RMASKHSQQ2B	€ 29,95
				Blanc	RMASKHSQBN2B	
				Noir	RMASKHSQNR2B	



RMASKHSQNR20



RMASKHSQGR20



RMASKHSQGF20



RMASKHSQBN20



RMASKHSQNR2B



RMASKHSQQ2B



RMASKHSQBN2B



RELASTNR0020

10,95 €
T.T.C.

EXC/EXCF 125 > 530 2000 > 2022 Élastiques de montage

Grille de radiateur

Protection totale de la partie supérieure et inférieure du radiateur de série. Elle couvre entièrement la partie qui reste sans protection avec le déflecteur standard. Elle évite également le contact avec le capot sur le dessus.

Nervures de renfort et structure en nid d'abeille pour une résistance accrue



RGRKTMNR0017



Cadre en technopolymère

RGRKTMGF0019

Grilles d'aération amovibles pour nettoyer les radiateurs sans outil.

Protection de radiateur inférieure horizontale. Empêche la collision entre le tuyau et le radiateur sur 250/300 2st.

OEM Couleur d'orig. - ☀ Fluo

MODEL	CC	ANNEE	NOTES	COULEUR	RÉFÉRENCE	PRIX	
TC	125	2016 > 2018	OEM	Blanc	☐	RGRKTMBN0017	€ 41,95
				Noir	☐	RGRKTMNR0017	
				Jaune fluo	☀	RGRKTMGF0017	
TX	125-150	2017 > 2019	OEM	Blanc	☐	RGRKTMBN0017	€ 41,95
				Noir	☐	RGRKTMNR0017	
				Jaune fluo	☀	RGRKTMGF0017	
TE / FE	150-250-300-350-450-501	2017 > 2019	OEM	Blanc	☐	RGRKTMBN0017	€ 41,95
				Noir	☐	RGRKTMNR0017	
				Jaune fluo	☀	RGRKTMGF0017	
FC	250-350-450	2016 > 2018	OEM	Blanc	☐	RGRKTMBN0017	€ 41,95
				Noir	☐	RGRKTMNR0017	
				Jaune fluo	☀	RGRKTMGF0017	
FS	450	2017-2018	OEM	Blanc	☐	RGRKTMBN0017	€ 41,95
				Noir	☐	RGRKTMNR0017	
				Jaune fluo	☀	RGRKTMGF0017	
TC / TX	250-350	2017-2018	OEM	Blanc	☐	RGRKTMBN0017	€ 41,95
				Noir	☐	RGRKTMNR0017	
				Jaune fluo	☀	RGRKTMGF0017	
FX	350-450	2017-2018	OEM	Blanc	☐	RGRKTMBN0017	€ 41,95
				Noir	☐	RGRKTMNR0017	
				Jaune fluo	☀	RGRKTMGF0017	
TC / FC	125-250-350-450	2019 > 2022	OEM	HSQ Yellow	☐	RGRKTMGQ0017	€ 43,95
				Noir	☐	RGRKTMNR0019	
				HSQ Yellow	☀	RGRKTMGF0019	
FC	450 Rockstar Edition	2018 > 2022	OEM	Jaune fluo	☀	RGRKTMGF0019	€ 43,95
				Noir	☐	RGRKTMNR0019	
				Blanc	☐	RGRKTMBN0019	
TX / FX	300-350-450	2019 > 2022	OEM	HSQ Yellow	☐	RGRKTMGQ0019	€ 43,95
				Jaune fluo	☀	RGRKTMGF0019	
				Noir	☐	RGRKTMNR0019	
FS	450	2019 > 2022	OEM	HSQ Yellow	☐	RGRKTMGQ0019	€ 43,95
				Jaune fluo	☀	RGRKTMGF0019	
				Noir	☐	RGRKTMNR0019	
TE / FE	150-250-300-350-450-501	2020 > 2022	OEM	HSQ Yellow	☐	RGRKTMGQ0019	€ 43,95
				Jaune fluo	☀	RGRKTMGF0019	
				Noir	☐	RGRKTMNR0019	
				HSQ Yellow	☐	RGRKTMGQ0019	
				Jaune fluo	☀	RGRKTMGF0019	
				Noir	☐	RGRKTMNR0019	

Bavette d'amortisseur



RPSPKTMNR016



RPSPKTMNR007

OEM Couleur d'orig.

MODEL	CC	ANNEE	NOTES	COULEUR	RÉFÉRENCE	PRIX
TC	65	2017 > 2022		Noir	RPSPKTMNR165	€ 18,95
TC	85	2014 > 2016		Noir	RPSPKTMNR985	€ 14,95
TC	85	2018 > 2022		Noir	RPSPKTMNR185	€ 14,95
TC / TE	449-511	2011 > 2013		Noir	RSPHSQNR011	€ 23,95
TC	125	2014-2015		Noir	RPSPKTMNR007	€ 14,95
TC	125	2016 > 2022		Noir	RPSPKTMNR016	€ 14,95
TC	250	2014 > 2016		Noir	RPSPKTMNR007	€ 14,95
TE / FE	125-250-300-350-450-501	2014 > 2016		Noir	RPSPKTMNR007	€ 14,95
FC	250-350-450	2014-2015		Noir	RPSPKTMNR007	€ 14,95
FC	250-350-450	2016 > 2021		Noir	RPSPKTMNR016	€ 14,95
TC / TX	250-300	2017 > 2021		Noir	RPSPKTMNR016	€ 14,95
FE/FS/FX/TE	125-150-250-300-350-450	2016 > 2021		Noir	RPSPKTMNR016	€ 14,95

Guide chaîne



RCRUKTMNRNT14

OEM Couleur d'orig.

MODEL	CC	ANNEE	NOTES	COULEUR	RÉFÉRENCE	PRIX
TC	65	2017 > 2022	OEM	Noir	RCRUKTMNR165	€ 23,95
TC	85	2014	OEM	Noir	RCRUKTMNR000	€ 23,95
TC	85	2015 > 2022	OEM - Bi-Material	NoirNeutral	RCRUKTMNRNT14	€ 38,95
TC / FC	125-250-350-450	2015 > 2022	OEM - Aluminum reinforced	Noir	RCRUKTMNR016	€ 38,95
TE / FE	125-150-250-300-350-450-501	2014 > 2022	OEM - Bi-Material	NoirNeutral	RCRUKTMNRNT14	€ 38,95
TX	125-150	2017 > 2022	OEM - Bi-Material	NoirNeutral	RCRUKTMNRNT14	€ 38,95
TX / FX / FS	300-350-450	2017 > 2022	Aluminum reinforced	Noir	RCRUKTMNR016	€ 38,95



GUIDE CHAÎNE MONOBLOCK R2.0 WORX
P. 2XX

Patin de chaîne

9,95 €
T.T.C.

PATTKTMR16

MODEL	CC	ANNEE	NOTES	COULEUR	RÉFÉRENCE
TC	125	2014-2015	OEM	Noir	RPATTKTMR11
				HSQ Bleu	RPATTKTMBLH11
TC	125	2016 > 2022	OEM	Noir	RPATTKTMR16
TC	250	2014 > 2016	OEM	Noir	RPATTKTMR11
				HSQ Bleu	RPATTKTMBLH11
TX	125-150-250-300	2017 > 2022	OEM	Noir	RPATTKTMR16
TC	250-300	2017 > 2022	OEM	Noir	RPATTKTMR16
FC	250-350-450	2014-2015	OEM	Noir	RPATTKTMR11
				HSQ Bleu	RPATTKTMBLH11
FC	250-350-450	2016 > 2022	OEM	Noir	RPATTKTMR16
TE / FE	125-250-300-350-450-501	2014 > 2016	OEM	Noir	RPATTKTMR11
				HSQ Bleu	RPATTKTMBLH11
TE/FE/FS/FX	125-150-250-300-350-450	2017 > 2022	OEM	Noir	RPATTKTMR16

Patin de bras oscillant



RSLIKTMNR085



RSLIKTMNR011

OEM Couleur d'orig.

MODEL	CC	ANNEE	NOTES	COULEUR	RÉFÉRENCE	PRIX
TC	65	2017 > 2022	OEM	Noir	RSLIKTMNR165	€ 25,95
TC	85	2014	OEM	Noir	RSLIKTMNR085	€ 25,95
TC	85	2015 > 2022	OEM	Noir	RSLIKTMNR185	€ 25,95
TC-TE-FE-FC-	125-150-250-300-350-	2014 > 2022	OEM	Noir	RSLIKTMNR011	€ 25,95

Kits plastiques



RKITHSQ-OEM-520

OEM Couleur d'orig. - ☀ Fluo

MODEL	CC	ANNEE	NOTES	COULEUR	RÉFÉRENCE	PRIX
TC	65	2017 > 2022	OEM	Blanc Noir	RKITHSQBN0565 RKITHSQNR0565	€ 129,95
TC	85	2014 > 2017	OEM 2016 OEM 2014-2015 et 2017	OEM Noir	RKITHSQOEM519 RKITHSQNR0509	€ 129,95
TC	85	2018 > 2022	OEM	Blanc Noir	RKITHSQOEM585 RKITHSQNR0585	€ 129,95
TC / FC Garde-boue avant ventilé	125-250-350-450	2014-2015	OEM 2014	☀ Jaune fluo Blanc-Noir Noir	RKITHSQGF0585 RKITHSQOEM508 RKITHSQNR0508	€ 129,95
TC Garde-boue avant ventilé	125	2016 > 2018	OEM 2016 OEM 2017-2018	Blanc-HSQ Bleu Blanc Noir	RKITHSQOEM516 RKITHSQBN0516 RKITHSQNR0516	€ 149,95
				☀ Jaune fluo Gris	RKITHSQGF0516 RKITHSQGR0516	
TC / FC Garde-boue avant ventilé	125-250-350-450	2019 > 2022	OEM 2020-2021 OEM 2019 et 2022	Blanc-Yellow-Grey Blanc-Yellow Blanc Noir	RKITHSQOEM529 RKITHSQOEM599 RKITHSQBN0599 RKITHSQNR0599	€ 149,95
				☀ Jaune fluo Gris Blanc-Yellow	RKITHSQGF0599 RKITHSQGR0599 RKITHSQOEM609	€ 172,95

Avec protection de fourche

MODEL	CC	ANNEE	NOTES	COULEUR		RÉFÉRENCE	PRIX
TC Garde-boue avant ventilé	250	2014 > 2016	OEM 2014	Blanc-Noir		RKITHSQOEM508	€ 129,95
TC / TX Garde-boue avant ventilé	250-300	2017-2018	OEM 2017-2018 OEM 2016	Noir		RKITHSQNR0508	
				Blanc		RKITHSQBN0516	€ 149,95
				Blanc-Bleu		RKITHSQOEM516	
				Noir		RKITHSQNR0516	
				☀ Jaune fluo		RKITHSQGF0516	
				Gris		RKITHSQGR0516	
TE / FE Garde-boue avant ventilé	125-250-300-350-450-501	2015-2016	OEM 2016 OEM 2015	Blanc-HSQ Bleu		RKITHSQOEM416	€ 124,95
				Blanc-Yellow		RKITHSQOEM411	
				Noir		RKITHSQNR0411	
TE / FE Garde-boue avant ventilé	150-250-300-350-450-501	2017-2019	OEM 2019 OEM 2017-2019	Blanc		RKITHSQBN0417	€ 139,95
				Blanc-HSQ Bleu		RKITHSQOEM417	
				Noir		RKITHSQNR0417	
				☀ Jaune fluo		RKITHSQGF0417	
TE / FE Garde-boue avant ventilé	150-250-300-350-450-501	2017-2019	OEM 2019-Blanc HEADLIGHT PLASTIC OEM 2017-2018	Blanc		RKITHSQBN0517	€ 149,95
				Blanc-HSQ Bleu		RKITHSQOEM517	
				Noir		RKITHSQNR0517	
				Gris		RKITHSQGR0517	
TX Garde-boue avant ventilé	125-150	2017-2019	OEM 2017-2019	Blanc		RKITHSQOEM417	€ 139,95
				Blanc-HSQ Bleu		RKITHSQBN0417	
				Noir		RKITHSQNR0417	
				☀ Jaune fluo		RKITHSQGF0417	
TX Garde-boue avant ventilé	125-150	2017-2019	OEM 2019-Blanc HEADLIGHT PLASTIC OEM 2017-2018	Blanc		RKITHSQBN0517	€ 149,95
				Blanc-HSQ Bleu		RKITHSQOEM517	
				Noir		RKITHSQNR0517	
				Gris		RKITHSQGR0517	
TX / FX Garde-boue avant ventilé	300-350-450	2019 > 2022	OEM 2020-2021 OEM 2019	Blanc-Yellow-Grey		RKITHSQOEM529	€ 149,95
				Blanc-Yellow		RKITHSQOEM599	
				Blanc		RKITHSQBN0599	
				Noir		RKITHSQNR0599	
				☀ Jaune fluo		RKITHSQGF0599	
				Gris		RKITHSQGR0599	
FC Garde-boue avant ventilé	250-350-450	2016 > 2018	Avec protection de fourche OEM 2017-2018 OEM 2016	Blanc-Yellow		RKITHSQOEM609	€ 172,95
				Blanc		RKITHSQBN0516	€ 149,95
				Blanc-HSQ Bleu		RKITHSQOEM516	
				Noir		RKITHSQNR0516	
				☀ Jaune fluo		RKITHSQGF0516	
				Gris		RKITHSQGR0516	
FC Garde-boue avant ventilé	450 Rockstar Edition	2018 > 2022		Blanc-Yellow-Grey		RKITHSQOEM529	€ 149,95
				Blanc-HSQ Yellow		RKITHSQOEM599	
				Blanc		RKITHSQBN0599	
				Noir		RKITHSQNR0599	
				☀ Jaune fluo		RKITHSQGF0599	
				Gris		RKITHSQGR0599	
FS / FX Garde-boue avant ventilé	350-450	2017-2018	Avec protection de fourche OEM 2017-2018 OEM 2016	Blanc-Yellow		RKITHSQOEM609	€ 172,95
				Blanc		RKITHSQBN0516	€ 149,95
				Blanc-HSQ Bleu		RKITHSQOEM516	
				Noir		RKITHSQNR0516	
				☀ Jaune fluo		RKITHSQGF0516	
				Gris		RKITHSQGR0516	
TE / FE Garde-boue avant ventilé	150-250-300-350-450-501	2020 > 2022	OEM	Blanc/Anthracite Grey		RKITHSQOEM420	€ 139,95
				Blanc		RKITHSQBN0420	
				Noir		RKITHSQNR0420	
			OEM	Blanc/Anthracite Grey		RKITHSQOEM520	€ 149,95
				Blanc		RKITHSQBN0520	
				Noir		RKITHSQNR0520	
				Gris		RKITHSQGR0520	
						RKITHSQBN0620	€ 172,95

PLASTIQUES RTECH

GAS GAS

Protection de fourche



RPSKTMBN0015



RPSKTMNR0015



RPSKTMRG0021

OEM Couleur d'orig.

MODEL	CC	ANNEE	NOTES	COULEUR	RÉFÉRENCE	PRIX	
MC	65	2021-2022	OEM	GG Rouge	RPSKTMRG1965	€ 29,95	
				Noir			RPSKTMNR1965
				Blanc			RPSKTMBN1965
MC	85	2021-2022	OEM	GG Rouge	RPSKTMRG0185	€ 31,95	
				Noir			RPSKTMNR0185
				Blanc			RPSKTMBN0185
EC/MC/FSR	125-200-250-300-450	2009 > 2013	OEM	GG Rouge	RPSKTMRG0008	€ 34,95	
				Blanc			RPSKTMBN0008
				Noir			RPSKTMNR0008
MC-MCF-EC- ECF-EX-EXF	125-250-300-350-450	2021-2022	OEM	GG Rouge	RPSKTMRG0021	€ 34,95	
				Blanc			RPSKTMBN0020
				Noir			RPSKTMNR0015

Grille de radiateur

OEM Couleur d'orig.

MODEL	CC	ANNEE	NOTES	COULEUR	RÉFÉRENCE	PRIX	
MC-MCF-EC- ECF-EX-EXF	125-250-300-350-450	2021-2022	OEM	GG Rouge	RGRKTMRG0019	€ 43,95	
				Blanc			RGRKTMBN0019
				Noir			RGRKTMNR0019

Bavette d'amortisseur

MODEL	CC	ANNEE	NOTES	COULEUR	RÉFÉRENCE	PRIX
MC	65	2021-2022	OEM	Noir	RPSPKTMNR165	€ 18,95
MC	85	2021-2022	OEM	Noir	RPSPKTMNR185	€ 14,95
MC/MCF/EX/EXF	125-250-300-350-450	2021-2022	OEM	Noir	RPSPKTMNR016	€ 14,95
EC/EC-F	125-250-300-350-450	2021-2022	OEM	Noir	RPSPKTMNR016	€ 14,95

Kits plastiques



RKITGASOEM404

OEM Couleur d'orig.

MOD	CC	ANNEE	NOTES	COULEUR	RÉFÉRENCE	PRIX
MC	65	2021-2022	OEM	GG Rouge		RKITKTMRG0500 € 129,95
				Noir		RKITKTMR0500
				Blanc		RKITKTMBN0500
MC	85	2021-2022	OEM	GG Rouge		RKITKTMRG0185 € 139,95
				Noir		RKITKTMBN0185
				Blanc		RKITKTMR0185
EC/MC/FSR	125-200-250-300-450	2007 > 2009	OEM	OEM		RKITGASOEM402 € 124,95
				Bleu		RKITGASBL0402
EC/MC/FSR	125-250-300-450	2010	OEM	OEM		RKITGASOEM403 € 124,95
EC/MC	125-200-250-300-450	2011	OEM	OEM		RKITGASOEM404 € 124,95
FSR	250	2011 > 2013	OEM	OEM		RKITGASOEM404 € 124,95
MC/MC-F/EX/EX-F Garde-boue avant ventilé	125-250-300-350-450	2021-2022	OEM	GG Rouge		RKITGASRG0599 € 149,95
				Gris		RKITGASGR0599
				GG Rouge		RKITGASRG0609 € 172,95
EC/EC-F Garde-boue avant ventilé	250-300-350	2021-2022	OEM	Rouge Blanc		RKITGASOEM421 € 139,95
				Rouge Blanc		RKITGASOEM521 € 149,95
				Gris		RKITGASGR0521 € 149,95
				Rouge Blanc		RKITGASOEM621 € 172,95

Guide chaîne

MODEL	CC	ANNEE	NOTES	COULEUR	RÉFÉRENCE	PRIX
MC	65	2021-2022	OEM	Noir	RCRUKTMNR165	€ 23,95
MC	85	2021-2022	OEM	Noir/Neutral	RCRUKTMNRNT14	€ 38,95
EC/EC-F	250-300-350	2021-2022	OEM	Noir/Neutral	RCRUKTMNRNT14	€ 38,95
MC/MCF/EX/EXF	125-250-300-350-450	2021-2022	OEM	Noir	RCRUKTMNR016	€ 38,95



Patin de chaîne

MODEL	CC	ANNEE	NOTES	COULEUR	RÉFÉRENCE	PRIX
EC/EC-F	125-250-300-350-450	2021-2022	OEM	Noir	RPATTKTMRN16	€ 9,95
MC/MCF/EX/EXF	125-250-300-350-450	2021-2022	OEM	Noir	RPATTKTMRN16	€ 9,95

Patin de bras oscillant

MODEL	CC	ANNEE	NOTES	COULEUR	RÉFÉRENCE	PRIX
MC	65	2021-2022	OEM	Noir	RSLIKTMNR165	€ 25,95
MC	85	2021-2022	OEM	Noir	RSLIKTMNR185	€ 25,95
EC/EC-F	250-300-350	2021-2022	OEM	Noir	RSLIKTMNR011	€ 25,95
MC/MCF/EX/EXF	125-250-300-350-450	2021-2022	OEM	Noir	RSLIKTMNR011	€ 25,95

PLASTIQUES RTECH

BETA

Protection de fourche

MOD	CC	ANNEE	NOTES	COULEUR	RÉFÉRENCE	PRIX
RR	125 > 480	2020 > 2022	OEM	Beta Rouge	 RPSBETRS0020	€ 34,95

Bavette d'amortisseur

MOD	CC	ANNEE	NOTES	COULEUR	RÉFÉRENCE	PRIX
RR	125 > 480	2020 > 2022	OEM	Noir	 RPSPBETNR020	€ 18,95

Guide chaîne

MOD	CC	ANNEE	NOTES	COULEUR	RÉFÉRENCE	PRIX
RR	125 > 480	2013 > 2022	OEM	Noir	 RSLIBETNR020	€ 25,95































































GUIDE CHÂÎNE MONOBLOCK R2.0 WORX
P. 2XX

Plaque phare

MOD	CC	ANNEE	NOTES	COULEUR	RÉFÉRENCE	PRIX
RR	125 > 480	2020 > 2022	OEM	Beta Rouge	 RMASKBETRS20	€ 29,95

Kits plastiques

MOD	CC	ANNEE	NOTES	COULEUR	RÉFÉRENCE	PRIX
RR	125 > 480	2020>2022	OEM 2022	Beta Rouge	      RKITBETRS0520	€ 147,95
RR	125 > 480	2020>2022	OEM 2022	Beta Rouge	      RKITBETBN0520	€ 172,95
				Blanc	      RKITBETNR0520	
				Noir	      RKITBETGR0520	
				Gris	      RKITBETGF0720	
RX	125 > 480	2020>2022	OEM 2022	Beta Rouge	      RKITBETRS0720	€ 172,95
				Blanc	      RKITBETBN0720	
				Noir	      RKITBETNR0720	
				Gris	      RKITBETGR0720	
				Jaune fluo	      RKITBETGF0720	



PLASTIQUES UNIVERSELS

Garde boue avant

29,95 €
T.T.C.

RPAYZFB911



RPAUNIBN000

Désignation	Couleur	Référence
Style RM 90	Blanc	RPAUNIBN0000
Style RM 90	Bleu	RPAUNIBL0000
Style RM 90	Noir	RPAUNINR0000
Style RM 90	Rouge	RPAUNIRS0000
Style YZF 10-16	Blanc	RPAYZFB911
Style YZF 10-16	Bleu	RPAYZFB911
Style YZF 10-16	Noir	RPAYZFN911
Style YZF 10-16	Rouge	RPAYZFR911

Garde boue avant supermoto

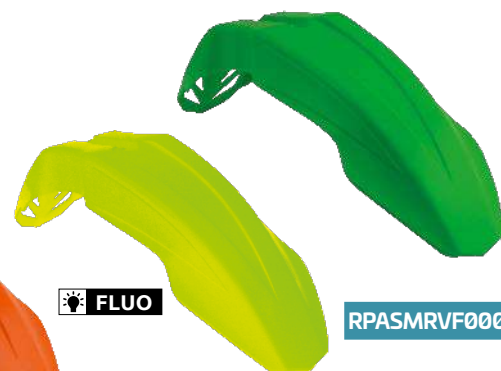
34,95 €
T.T.C.

RPASMRVF0006

FLUO

RPASMRGF0006



RPASMRAR0006

RPASMRRS0006

Désignation	Référence
Orange	RPASMRAR0006
Blanc	RPASMRBN0006
Bleu TM	RPASMRBLTM06
Bleu YZ	RPASMRBL0006
Jaune RMZ	RPASMRGI0006
Noir	RPASMRNR0006
Rouge CRF	RPASMRRS0006
Vert KXF	RPASMRVE0006
Jaune fluo	RPASMRGF0006

Plaque phare V-Face

79,95 €
T.T.C.

Conception innovante

Phare universel, pour l'utilisation sur route, composé de deux éléments aux couleurs interchangeables. Il se fixe avec quatre vis.

Fourni avec 4 élastiques à fixer à la fourche.

Grand trou pour le tube de frein avant.



VENTILATION



LIGHT
WEIGHT



ENDURO



UNIVERSAL
MOUNTING



RMASKARNR008



RMASKBNNR008



RMASKNR0008



RMASKBLNR008



Plaque phare Genesis

64,95 €
T.T.C.

Design fin et compact

Phare en polypropylène avec lumière homologué 12 V - 35 W.

Quatre élastiques à fixer sur la fourche et un large trou pour le tube de frein avant.



VENTILATION



LIGHT
WEIGHT



ENDURO



UNIVERSAL
MOUNTING



RMASKGI00006



RMASKAR00006



RMASKRS00006



RMASKBN00006



RMASKNR00006



RMASKBL00006



RMASKVE00006

Plaque phare Matrix

64,95 €
T.T.C.

La plaque phare universelle Matrix est réalisée en polypropylène, résistante aux chocs et dotée d'un éclairage homologué 12V / 35W.

Livré avec quatre bandes à fixer à la fourche et avec un trou pour le tube de frein avant.



RMASKBN00007



RMASKNR00007



Accessoires



Adaptateurs

RDSMASK6NR00

10,95 €
T.T.C.



Élastique de montage

RELASTNR0006 - V-Face, Genesis, Matrix

18,95 €
T.T.C.

Support de plaque Extreme

39,95 €
T.T.C.



RPTLED4NR006



RPTLED3NR006



RLEDRS000006

19,95 €
T.T.C.



RLENTNT00006

15,95 €
T.T.C.



RLENTS00006

15,95 €
T.T.C.

Kit LED R3000

Plus de visibilité

Conduire la nuit avec pratiquement la même visibilité que la journée. Tous les composants électriques et électroniques sont intégrés dans une seule fonte d'aluminium pour minimiser le poids, le volume et éviter les ruptures désagréables.

Grâce à une conception unique, la luminosité est puissante, la lampe est légère, fiable et simple à installer.

Le kit comprend des adaptateurs conçus pour des lampes de types H1, H2, H3, H4, H7, KTM d'origine et Sherco.

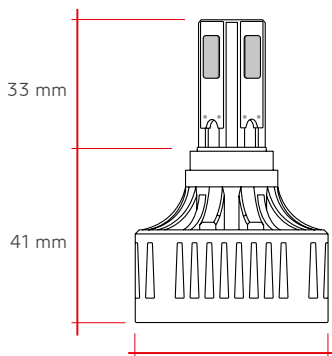

32W - 12 V - 3A - 120/160 kHz
3000/2200 lumen - IP68
Blanc pur 6 000 K



RLEDRTECH016

64,95 €
T.T.C.

Luminosité
+ 300%
Homologation :
CE - ROHS - DOT

Lampe halogène



Kit Led R3000



Grâce aux adaptateurs **INCLUS**, le remplacement de la lampe halogène d'origine est simple et rapide.

PLUG et PLAY SANS OUTILS



1 Retirer la lampe halogène



2 Insérer l'adaptateur



3 Insérer le ressort et la lampe led



4 Tourner la lampe jusqu'au blocage.

Cales pour plaque phare 11,95 €
T.T.C.

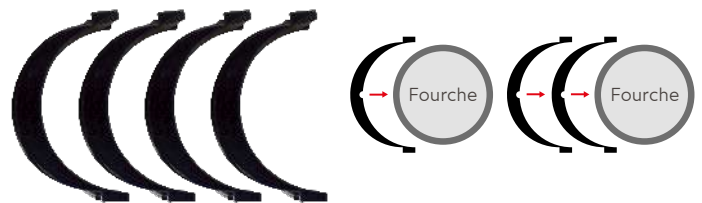

RDSMASK16NR

Cales en demie lune pour V-Face, Matrix et Genesis

Support de plaque arrière Integra Led

59,95 €
I.T.C.



KTM
RPTLEDONR016

HUSQVARNA
RPTLEDONR017

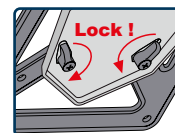

Application

KTM XC/W / EXC / EXCF - 125 => 500 - 2017-2018

HUSQVARNA TE / FE / TX - 125-250-300-350-450-501 - 2017-2018

Référence

RPTLEDONR016

RPTLEDONR017

Support de plaque arrière Devil

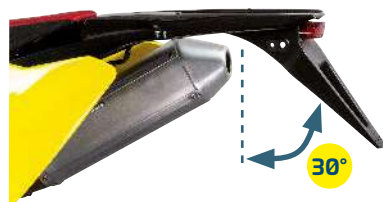

Homologué route angle de 30°
RPTLEDONR008

54,95 €
I.T.C.

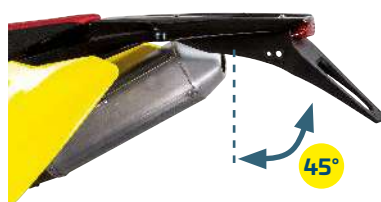

Angle de 45°
RPTLEDONR007

54,95 €
I.T.C.



Led de remplacement
RLEDRS000007

35,95 €
I.T.C.



PROTÈGE MAINS

HP1

43,95 €
T.T.C.

- Fabriqué en bi-matière, résistant et flexible
- Excellente durabilité, légèreté et ventilation
- Réglable dans différentes positions latérales
- Inclut le kit de fixations pour guidon et levier



Deux montages possibles !



Kit de montage pour guidon inclus



Kit de montage pour leviers inclus



RKITPMHP1BN0 - Blanc



RKITPMHP1NR0 - Noir



RKITPMHP1VE0 - Vert KXF



RKITPMHP1AR0 - Orange K



RKITPMHP1RS0 - Rouge CRF



RKITPMHP1BL0 - Bleu YZF



RKITPMHP1AN0 - Orange fluo



RKITPMHP1GI0 - Jaune RMZ



RKITPMHP1GF0 - Jaune fluo



NOUVEAUTÉ

HP1 BRAKTEC

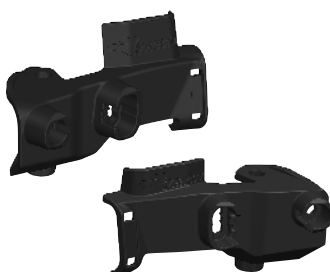
38,95 €
T.T.C.

**KIT DE MONTAGE SPÉCIFIQUE EN NYLON SUR LEVIERS.
POUR MOTOS ÉQUIPÉES DE COMMANDE D'EMBRAYAGE HYDRAULIQUE**

GASGAS EC/ECF 2021-2022 | HUSQVARNA TE/FE 2020>2022



RKITPMHP1BN3 - Blanc



RKITPMHP1RG3 - CR Rouge

 FLUO
 RKITPMHP1GF3 - Jaune fluo

HONDA CRF 450 2021-2022 | KAWASAKI KX 250 2019>2022 KX 450 2021>2022



RKITPMHP1VE4 - KX Green



RKITPMHP1RS4 - CR Rouge





NOUVEAUTÉ

HP1 scrambler

RKITPMHP1NR2

94,95 €
T.T.C.

Sa ligne épurée correspond parfaitement aux scrambler et naked les plus populaires

Bi-matière, robuste et souple pour une excellente résistance, légèreté et ventilation

Facile à monter grâce au kit de montage avec "double cône" qui évite la rotation après verrouillage

Kit de montage inclus

Extenseurs en acier galvanisé pour guidon avec trou intérieur



ø 14-18 mm



ø 16-17 mm



ø 18-20,5 mm

UNIVERSAL
MOUNTINGSCRAMBLER
DUAL ROADAFV
VENTILATIONADVENTURE
NAKEDATV
ALL TERRAINLIGHT
WEIGHT2
BI-MATERIAL

HP2

38,95 €
I.T.C.

Utilisable à l'envers !

- Fabriqué avec un matériau spécial en technopolymère
- Résistance maximale dans la partie centrale, caoutchouc et surface flexible avec effet carbone tout autour
- Excellente durabilité, légèreté et ventilation
- Réglable dans différentes positions latérales
- Kit de fixation du guidon inclus
- Plastiques de protection en tant que pièce de rechange pour KTM, Husqvarna et Sherco utilisant des supports de série

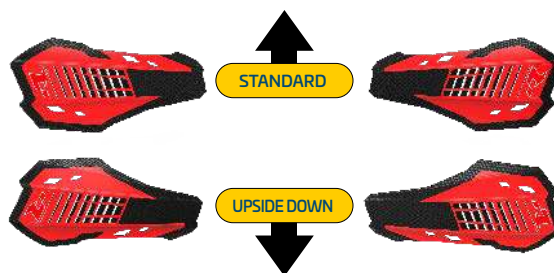

Kit de montage pour guidon inclus



RKITPMHP2AN0 - Orange fluo



RKITPMHP2NR0



RKITPMHP2BN0



RKITPMHP2AR0 - Orange K



RKITPMHP2BL0 - Bleu YZ



RKITPMHP2GF0 - Jaune fluo



RKITPMHP2GI0 - Jaune



RKITPMHP2RS0 - Rouge CRF



RKITPMHP2VE0 - Vert KXF



NOUVEAUTÉ

HP2 BRAKTEC

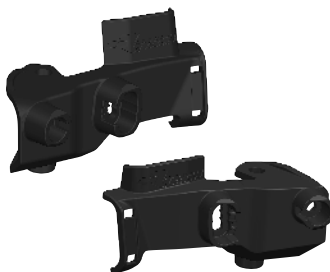

38,95 €
T.T.C.

**KIT DE MONTAGE SPÉCIFIQUE EN NYLON SUR LEVIERS.
POUR MOTOS ÉQUIPÉES DE COMMANDE D'EMBRAYAGE HYDRAULIQUE**

GASGAS EC/ECF 2021-2022 | HUSQVARNA TE/FE 2020>2022



RKITPMHP2RG3 - Gas Gas rouge



RKITPMHP2BN1 - Blanc



RKITPMHP2GF1 - Jaune fluo

HONDA CRF 450 2021-2022 | KAWASAKI KX 250 2019>2022 KX 450 2021>2022



RKITPMHP2VE2 - KX Green



RKITPMHP2RS2 - CR Rouge

HP3

43,95 €
T.T.C.

Cross & Enduro

- Fabriqué en technopolymère, solide et flexible
- Excellente durabilité, légèreté et ventilation
- Réglable dans différentes positions latérales
- Fourni avec 2 kits de montage

Deux montages possibles !



Kit de montage pour guidon inclus



Kit de montage pour leviers inclus



RHP3ENDNR000



RHP3ENDBNNR0



RHP3ENDNRAN0 - Noir orange fluo



RHP3ENDARNR0 - Orange K



RHP3ENDVENR0 - Vert KXF



RHP3ENDGINR0 - Jaune RMZ



RHP3ENDNRGF0 - Noir jaune fluo



RHP3ENDGRNR0 - Gris quantum



RHP3ENDRSBN0 - Blanc rouge CRF



RHP3ENDBLBN0 - Blanc bleu YZ



NOUVEAUTÉ

HP3 BRAKTEC

Kit de montage spécifique sur leviers



38,95 €
T.T.C.

**KIT DE MONTAGE SPÉCIFIQUE EN NYLON SUR LEVIERS.
POUR MOTOS ÉQUIPÉES DE COMMANDE D'EMBRAYAGE HYDRAULIQUE**

GASGAS EC/ECF 2021-2022 | HUSQVARNA TE/FE 2020>2022



RKITPMHP3BN3



RKITPMHP3GF3

HONDA CRF 450 2021-2022 | KAWASAKI KX 250 2019>2022 KX 450 2021>2022



RKITPMHP3RS4



RKITPMHP3VE4



Fabriqué en technopolymère spécial, solide et flexible offrant une excellente protection, durabilité, légèreté et stabilité à haute vitesse
Réglage micrométrique de la hauteur. Boudier supplémentaire transparent
Kit de montage spécifique vendu séparément

CONFIGURATION DE MONTAGE 1

BMW GS 1200/1250 - BMW GS 700/800 - HONDA AFRICA TWIN 1000/1100 - YAMAHA SUPERTENERE' 700/1200 - KTM ADV/DUCATI MULTISTRADA

KIT DE MONTAGE NON INCLUS



CONFIGURATION DE MONTAGE 2

ATV mounting kit / Kit di montaggio ATV / ADVENTURE

KIT DE MONTAGE NON INCLUS

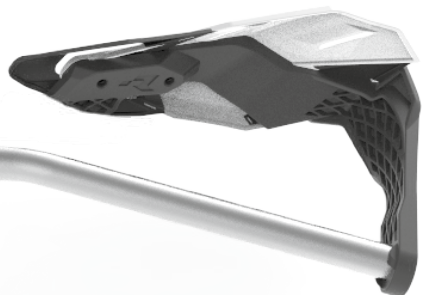

HP3 ADVENTURE 74,95 € T.T.C.

- UNIVERSAL MOUNTING
- VENTILATION
- SCRAMBLER DUAL ROAD
- ALL TERRAIN
- ADVENTURE NAKED
- LIGHT WEIGHT
- BI-MATERIAL



RHP3ADVNR000



FLUO

RHP3ADVNRAN0



RHP3ADVGINR0



RHP3ADVARNR0



RHP3ADVGRNR0



RHP3ADVBLBN0



FLUO

RHP3ADVNRGF0



RHP3ADVRSBN0

KITS DE MONTAGE 43,95 € T.T.C.



RKITMOUNTGS1

KIT DE MONTAGE POUR :
BMW GS 1200/1250
GUIDON >22 > 28



RKITMOUNTGS8

KIT DE MONTAGE POUR :
BMW GS 700/800
GUIDON >22 > 28



RKITMOUNTAFR

KIT DE MONTAGE POUR :
HONDA AFRICA TWIN
1000/1100
GUIDON >22 > 28



RKITMOUNTXTZ

KIT DE MONTAGE POUR :
YAMAHA SUPERTENERE
700/1200
GUIDON >22 > 28



RKITMOUNTADV

KIT DE MONTAGE POUR :
KTM ADV / DUCATI
MULTISTRADA
GUIDON >22 > 28

FLX

43,95 €
T.T.C.



RKITPMFLRS00



RKITPMFLGF00
Jaune fluo



RKITPMFLAR00



RKITPMFLNR00



RKITPMFLGI00



RKITPMFLVE00



RKITPMFLBL00



RKITPMFLAN00
Orange fluo



RKITPMFLFU00



RKITPMFLBN00

Deux montages possibles !



Kit de montage pour guidon inclus



Kit de montage pour leviers inclus

4 configurations possibles - Accessoires inclus



FLX Alu

74,95 €
T.T.C.



RKITPMFMGF00 - Jaune fluo



RKITPMFMR00



RKITPMFMR00



RKITPMFMNR00



RKITPMFMGI00



RKITPMFMVE00



RKITPMFMBM00



RKITPMFMAN00
Orange fluo



RKITPMFMFU00



RKITPMFMBN00

Kit de montage NON inclus





Vertigo



RKITPMVTGF00 - Jaune fluo



VENTILATION



UNIVERSAL MOUNTING



LIGHT WEIGHT



MOTOCROSS



ENDURO



INMOULD PLASTIC LABEL



Montage standard



Montage inversé



Kit de montage pour guidon inclus



32,95 € T.T.C.



RKITPMVTRS00



RKITPMVTNR00



RKITPMVTAR00



RKITPMVTBN00



RKITPMVTVE00



RKITPMVTGI00



RKITPMVTAN00
Orange fluo



RKITPMVTBL00

Protège mains Vertigo ATV



RKITPMATVAR0 - Orange



UNIVERSAL MOUNTING



ALL TERRAIN



INMOULD PLASTIC LABEL

79,95 € T.T.C.



RKITPMATVGI0



RKITPMATVBL0



RKITPMATVRS0



RKITPMATVVE0



RKITPMATVBN0



RKITPMATVNR0



RKITPMATVGF0
Jaune fluo

Kit de montage inclus

Vertigo Alu

69,95 €
T.T.C.



RKITPMVMS00 - Rouge



RKITPMVMGI00



RKITPMVMAR00



RKITPMVMBN00



RKITPMVMVE00



RKITPMVMNR00



RKITPMVMBL00



RKITPMVMGF00 - Jaune fluo



RKITPMVMAN00 - Orange fluo

Kit de montage NON inclus



DUAL EVO

32,95 €
T.T.C.

Champion du monde enduro
2021 avec Steve HOLCOMBE,
BETA Factory

Nouveaux protège-mains doubles avec support pour guidon identiques aux modèles Vertigo et FLX.

Montage et ajustement indépendamment des leviers.
Fournis avec des connexions universelles en nylon.



RKITPMDUBN14 - Blanc



Kit de montage pour guidon inclus



RKITPMDURS14 - Rouge CRF



RKITPMDUAR14 - Orange K



RKITPMDUNR14



RKITPMDUVE14 - Vert KXF



RKITPMDUGI14 - Jaune RMZ



RKITPMDUBL14 - Bleu YZF



Kits de montage pour protège mains



Kit de montage ajustable
RKITMOUNT003

52,95 €
I.T.C.



Kit de montage renforcé
RKITMOUNT005

49,95 €
I.T.C.



Kit de montage nylon
RKITMOUNT014

27,95 €
I.T.C.

Entretoises pour guidon percés 19,95 €
I.T.C.



FLX ALU



VERTIGO ALU

ø 14-15,5 mm



RKITEXP014AC

ø 16-17,5 mm



RKITEXP016AC

ø 18-20,5 mm



RKITEXP018AC

PROTECTIONS

Protection moteur

- Fabriqué en technopolymère
- Montage parfait sur le cadre et le carter moteur
- Absence totale de vibrations



Adaptateurs de montage en acier pour modèles :
KTM/Husqvarna 2016 > 2018



PROTECTION DE BIELLETES

BRAND	MODEL	CC	ANNEE	NOTE	COULEUR	RÉFÉRENCE	PRIX	
HONDA	CRF	250	2018 > 2021	PROTECTION DE BIELLETES NON INCLUSE	Noir	RPMCRFNR0017	€ 74,95	
	CRF / CRF-RX	250	2022	PROTECTION DE BIELLETES NON INCLUSE	Noir	RPMCRFNR0021	€ 74,95	
	CRF-RX	250	2019 > 2021	PROTECTION DE BIELLETES NON INCLUSE	Noir	RPMCRFNR0017	€ 74,95	
	CRF / CRF-RX	450	2017 > 2020	PROTECTION DE BIELLETES NON INCLUSE	Noir	RPMCRFNR0017	€ 74,95	
	CRF/CRF-RWE/	450	2021-2022	PROTECTION DE BIELLETES NON INCLUSE	Noir	RPMCRFNR0021	€ 74,95	
	CRFX/ CRF-L	450	2019 > 2022	PROTECTION DE BIELLETES NON INCLUSE	Noir	RPMCRFNR0017	€ 74,95	
Link protection	CRF	250	2018 > 2021	Pour HONDA*	Noir	RPRTLINK01NR	€ 18,95	
	CRF-RX	250	2019 > 2021	Pour HONDA*	Noir	RPRTLINK01NR	€ 18,95	
	CRF / CRF-RX	250	2022	Pour HONDA*	Noir	RPRTLINK01NR	€ 18,95	
	CRF / CRF-RX	450	2017 > 2020	Pour HONDA*	Noir	RPRTLINK01NR	€ 18,95	
	CRF/ CRF-RX/ CRF-RWE	450	2021-2022	Pour HONDA*	Noir	RPRTLINK01NR	€ 18,95	
	CRFX/ CRF-L	450	2019 > 2022	Pour HONDA*	Noir	RPRTLINK01NR	€ 18,95	
YAMAHA	YZ / YZ-X	125	2005 > 2022	PROTECTION DE BIELLETES NON INCLUSE	Noir	RPMYZ0NR0125	€ 74,95	
	YZ / YZ-X	250	2005 > 2022	PROTECTION DE BIELLETES NON INCLUSE	Noir	RPMYZ0NR0250	€ 74,95	
	YZF	250	2019 > 2022	PROTECTION DE BIELLETES NON INCLUSE	Noir	RPMYZFNR0018	€ 74,95	
	YZ-FX	250	2020 > 2022	PROTECTION DE BIELLETES NON INCLUSE	Noir	RPMYZFNR0018	€ 74,95	
	YZF	450	2018 > 2022	PROTECTION DE BIELLETES NON INCLUSE	Noir	RPMYZFNR0018	€ 74,95	
	YZ-FX	450	2019 > 2022	PROTECTION DE BIELLETES NON INCLUSE	Noir	RPMYZFNR0018	€ 74,95	
	WRF	250	2020 > 2022	PROTECTION DE BIELLETES NON INCLUSE	Noir	RPMYZFNR0018	€ 74,95	
	WRF	450	2019 > 2022	PROTECTION DE BIELLETES NON INCLUSE	Noir	RPMYZFNR0018	€ 74,95	
	Link protection	YZ	125-250	2005 > 2022	Pour YAMAHA*	Noir	RPRTLINK01NR	€ 18,95
		YZ	250	2019 > 2022	Pour YAMAHA*	Noir	RPRTLINK01NR	€ 18,95
YZ-FX		250	2020 > 2022	Pour YAMAHA*	Noir	RPRTLINK01NR	€ 18,95	
YZ		450	2018 > 2022	Pour YAMAHA*	Noir	RPRTLINK01NR	€ 18,95	
YZ-FX		450	2019 > 2022	Pour YAMAHA*	Noir	RPRTLINK01NR	€ 18,95	
WRF		250	2020 > 2022	Pour YAMAHA*	Noir	RPRTLINK01NR	€ 18,95	
KAWASAKI	WRF	450	2019 > 2022	Pour YAMAHA*	Noir	RPRTLINK01NR	€ 18,95	
	KX	250	2021 > 2022	PROTECTION DE BIELLETES NON INCLUSE	Noir	RPMKX0NR0021	€ 74,95	
	KX-XC	250-450	2021 > 2022	PROTECTION DE BIELLETES NON INCLUSE	Noir	RPMKX0NR0021	€ 74,95	
Link protection	KX	450	2020 > 2022	PROTECTION DE BIELLETES NON INCLUSE	Noir	RPMKX0NR0021	€ 74,95	
	KX	250	2021 > 2022	Pour Kawasaki*	Noir	RPRTLINK02NR	€ 18,95	
	KX-XC	250-450	2021 > 2022	Pour Kawasaki*	Noir	RPRTLINK02NR	€ 18,95	
	KX	450	2020 > 2022	Pour Kawasaki*	Noir	RPRTLINK02NR	€ 18,95	

BRAND	MODEL	CC	ANNEE	NOTE	COULEUR	RÉFÉRENCE	PRIX
KTM	SX	125	2016 > 2020	PROTECTION DE BIELLETES NON INCLUSE	Noir	RPMKTMNR4519	€ 74,95
	XC-W	125-150	2017 > 2019	PROTECTION DE BIELLETES NON INCLUSE	Noir	RPMKTMNR4519	€ 74,95
	XC-W-TPI	150	2020	PROTECTION DE BIELLETES NON INCLUSE	Noir	RPMKTMNR4519	€ 74,95
	SXF	250-350	2016 > 2018	PROTECTION DE BIELLETES NON INCLUSE	Noir	RPMKTMNR4519	€ 74,95
	EXCF	250-350	2017 > 2022	PROTECTION DE BIELLETES NON INCLUSE	Noir	RPMKTMNR4519	€ 74,95
	EXCF	450-500	2017 > 2022	PROTECTION DE BIELLETES NON INCLUSE	Noir	RPMKTMNR4519	€ 74,95
	SX/EXC/XC-W	250-300	2017 > 2022	PROTECTION DE BIELLETES NON INCLUSE	Noir	RPMKTMNR4519	€ 74,95
	SXF/XC-F	250-350	2019 > 2022	PROTECTION DE BIELLETES NON INCLUSE	Noir	RPMKTMNR4519	€ 74,95
	SXF	450	2016 > 2018	PROTECTION DE BIELLETES NON INCLUSE	Noir	RPMKTMNR4519	€ 74,95
	SXF/XC-F	450	2019 > 2022	PROTECTION DE BIELLETES NON INCLUSE	Noir	RPMKTMNR4519	€ 74,95
	Link protection	SX-SXF-XC	125-250-350-450	2016 > 2022	Pour KTM*	Noir	RPRTLINK02NR
HUSQVARNA	TC	125	2016 > 2022	PROTECTION DE BIELLETES NON INCLUSE	Noir	RPMKTMNR0125	€ 74,95
	TE / TX	125-150	2017 > 2019	PROTECTION DE BIELLETES NON INCLUSE	Noir	RPMKTMNR0125	€ 74,95
	TE-I	150	2020 > 2022	PROTECTION DE BIELLETES NON INCLUSE	Noir	RPMKTMNR0150	€ 74,95
	FC	250-350	2016 > 2018	PROTECTION DE BIELLETES NON INCLUSE	Noir	RPMKTMNR2518	€ 74,95
	FC/FX	250-350	2019 > 2022	PROTECTION DE BIELLETES NON INCLUSE	Noir	RPMKTMNR2519	€ 74,95
	FC	450	2016 > 2018	PROTECTION DE BIELLETES NON INCLUSE	Noir	RPMKTMNR4518	€ 74,95
	FC/FX	450	2019 > 2022	PROTECTION DE BIELLETES NON INCLUSE	Noir	RPMKTMNR4519	€ 74,95
	FE	250-350	2017 > 2022	PROTECTION DE BIELLETES NON INCLUSE	Noir	RPMKTMNR2518	€ 74,95
	TC	250	2017 > 2022	PROTECTION DE BIELLETES NON INCLUSE	Noir	RPMKTMNR3018	€ 74,95
	TE-TX	250-300	2017 > 2022	PROTECTION DE BIELLETES NON INCLUSE	Noir	RPMKTMNR3018	€ 74,95
	FE-FS-FX	450-500	2017 > 2022	PROTECTION DE BIELLETES NON INCLUSE	Noir	RPMKTMNR4518	€ 74,95
Link protection	FC	450	2016 > 2022	Pour HUSQVARNA*	Noir	RPRTLINK02NR	€ 18,95
	FE-FS-FX	450-500	2017 > 2022	Pour HUSQVARNA*	Noir	RPRTLINK02NR	€ 18,95
GAS GAS	MC	125	2021-2022	PROTECTION DE BIELLETES NON INCLUSE	Noir	RPMKTMNR0125	€ 74,95
	EC	250-300	2021-2022	PROTECTION DE BIELLETES NON INCLUSE	Noir	RPMKTMNR3018	€ 74,95
	MC-F	250	2021-2022	PROTECTION DE BIELLETES NON INCLUSE	Noir	RPMKTMNR2519	€ 74,95
	EC-F	250-350	2021-2022	PROTECTION DE BIELLETES NON INCLUSE	Noir	RPMKTMNR2519	€ 74,95
	MC-F	450	2021-2022	PROTECTION DE BIELLETES NON INCLUSE	Noir	RPMKTMNR4519	€ 74,95
	Link protection	MC/MC-F/EC/EC-F	125-250-300-350-450	2021-2022	Pour GAS GAS*	Noir	RPRTLINK02NR
BETA	RR	250-300	2013 > 2019	PROTECTION DE BIELLETES NON INCLUSE	Noir	RPMBETNR3019	€ 74,95
	RR	250-300	2020 > 2022	PROTECTION DE BIELLETES NON INCLUSE	Noir	RPMBETNR3020	€ 74,95
	RR	350 > 530	2020 > 2022	PROTECTION DE BIELLETES NON INCLUSE	Noir	RPMBETNR4520	€ 74,95
	X-TRAINER	250-300	2015 > 2022	PROTECTION DE BIELLETES NON INCLUSE	Noir	RPMBETNR3019	€ 74,95
	RR	125	2020 > 2022	PROTECTION DE BIELLETES NON INCLUSE	Noir	RPMBETNR1220	€ 74,95
	Link protection	RR	250-300	2013 > 2022	Pour BETA*	Noir	RPRTLINK02NR
	RR	350 > 530	2011 > 2022	Pour BETA*	Noir	RPRTLINK02NR	€ 18,95
	X-TRAINER	250-300	2015 > 2022	Pour BETA*	Noir	RPRTLINK02NR	€ 18,95
FANTIC	XX / XE	125	2021-2022	PROTECTION DE BIELLETES NON INCLUSE	Noir	RPMYZ0NR0125	€ 74,95
	XX / XE	250	2021-2022	PROTECTION DE BIELLETES NON INCLUSE	Noir	RPMYZ0NR0250	€ 74,95
	XXF / XEF	250-450	2021-2022	PROTECTION DE BIELLETES NON INCLUSE	Noir	RPMYZFNR0018	€ 74,95
Link protection	XX/XE/XXF/XEF	125-250-450	2021-2022	Pour FANTIC*	Noir	RPRTLINK01NR	€ 18,95





Protection disque avant

26,95 €
T.T.C.



RDISCPBN000



RDISCPNR000



RDISCPAR000



RDISCPTR000



RDISCPGF000



RDISCPBL000



RDISCPGI000



RDISCPVE000

En matériaux à hautes performances thermiques et mécaniques.

Ligne épurée, orifices de ventilation.

Aérodynamique.

Nécessite un kit de montage



Kit de montage 43,95 € I.T.C.

Aluminium, usinage CNC.

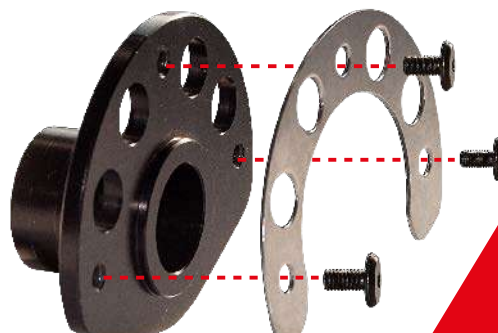

BRAND	MODEL	CC	ANNEE	RÉFÉRENCE
HONDA	CR/CRF-R/CRF-RX/ /CRFX/CRF-L	125 > 450	2004 > 2022	RKITMOUNT100
YAMAHA	YZ	125-250	2004 > 2022	RKITMOUNT103
	YZ-X	125	2020 > 2022	RKITMOUNT103
	YZF	250-450	2004 > 2013	RKITMOUNT103
	YZF	250-450	2014 > 2022	RKITMOUNT104
	YZ-X	250	2016 > 2022	RKITMOUNT103
	YZ-FX	250	2015 > 2022	RKITMOUNT104
	YZ-FX	450	2016 > 2022	RKITMOUNT104
	WR	250	2016 > 2022	RKITMOUNT103
	WRF	250	2004 > 2013	RKITMOUNT103
	WRF	250	2015 > 2022	RKITMOUNT104
	WRF	450	2004 > 2015	RKITMOUNT103
	WRF	450	2016 > 2022	RKITMOUNT104
KAWASAKI	KXF	250	2006 > 2020	RKITMOUNT105
	KXF	250	2021-2022	RKITMOUNT109
	KXF	450	2006 > 2018	RKITMOUNT105
	KXF	450	2019 > 2022	RKITMOUNT109
	KLX	450	2007 > 2016	RKITMOUNT105
SUZUKI	KX-XC	250-450	2021-2022	RKITMOUNT109
	RMZ	250	2007 > 2022	RKITMOUNT106
	RMZ	450	2005 > 2022	RKITMOUNT106
	RMX	450	2010 > 2022	RKITMOUNT106
KTM	SX / SXF	125 > 525	2004 > 2014	RKITMOUNT101
	SX / SXF	125 > 450	2015 > 2022	RKITMOUNT102
	EXC / EXCF	125 > 530	2004 > 2015	RKITMOUNT101
	EXC / EXCF	125 > 500	2016 > 2022	RKITMOUNT102
HUSQVARNA	TC / FC	125 > 450	2014	RKITMOUNT101
	TC / FC	125 > 450	2015 > 2022	RKITMOUNT102
	TE / FE	125 > 510	2014-2015	RKITMOUNT101
	TE / FE	125 > 510	2016 > 2022	RKITMOUNT102
GAS GAS	MC/MC-F/EC/ECF	125-250-300-350-450	2021-2022	RKITMOUNT102
BETA	RR	125 > 530	2013 > 2022	RKITMOUNT107
SHERCO	SE / SEF	125 > 500	2013 > 2022	RKITMOUNT108
FANTIC	XX / XE	125-250	2021-2022	RKITMOUNT103
	XXF / XEF	250-450	2021-2022	RKITMOUNT104



Protection de bras oscillant

49,95 €
I.T.C.

Résistant aux rayures sur les rochers et les obstacles

Système de fixation par les vis d'origine sous le patin de chaîne et le guide câble de frein afin d'éviter le problème habituel de glisser vers l'arrière lorsque vous utilisez uniquement les attaches zippées traditionnelles

BRAND	MODEL	CC	ANNEE	COULEUR	RÉFÉRENCE	PRIX
HONDA	CRF / CRF-RX	250	2022	Noir	RPFCCRFRNR001	€ 49,95
	CRF/CRF-RWE/ CRF-RX	450	2021-2022	Noir	RPFCCRFRNR001	€ 49,95
YAMAHA	YZF	250	2009 > 2022	Noir	RPFCYZFNR001	€ 49,95
	YZ-FX	250	2015 > 2022	Noir	RPFCYZFNR001	€ 49,95
	YZF	450	2009 > 2022	Noir	RPFCYZFNR001	€ 49,95
	YZ-FX	450	2016 > 2022	Noir	RPFCYZFNR001	€ 49,95
	WRF	250	2015 > 2022	Noir	RPFCYZFNR001	€ 49,95
KTM	WRF	450	2016 > 2022	Noir	RPFCYZFNR001	€ 49,95
	SX	125-150-250	2011	Noir	RPFCKTMNR001	€ 49,95
	SX	125-150-250	2012 > 2022	Noir	RPFCKTMNR002	€ 49,95
	SXF	250 > 450	2011 > 2022	Noir	RPFCKTMNR002	€ 49,95
HUSQVARNA	EXC/XC-W	125 > 500	2012 > 2022	Noir	RPFCKTMNR001	€ 49,95
	TC/FC/TE/FE	125 > 501	2014 > 2022	Noir	RPFCKTMNR002	€ 49,95
GAS GAS	MC/MC-F/EC/EC-F	125-250-300-350-450	2021-2022	Noir	RPFCKTMNR002	€ 49,95
BETA	RR	125 > 530	2013 > 2019	Noir	RPFCBETNR001	€ 49,95
	RR	125 > 480	2020 > 2022	Noir	RPFCBETNR002	€ 49,95
	XTRAINER	250-300	2015 > 2020	Noir	RPFCBETNR001	€ 49,95
	XTRAINER	250-300	2021-2022	Noir	RPFCBETNR002	€ 49,95
FANTIC	XXF / XEF	250-450	2021-2022	Noir	RPFCYZFNR001	€ 49,95



Protection de cadre

36,95 €
T.T.C.

Bi-matière : plastique et caoutchouc

épaisseur minimale sur le cadre

Logo RTech imprimé directement sur la surface en caoutchouc

Adapté aux modèles ktm, husqvarna et beta

BRAND	MODEL	CC	ANNEE	COULEUR	RÉFÉRENCE
HONDA	CRF/CRF-RX	250	2022	CR Rouge/Noir	RPRTCRCFRNR1
	CRF/CR-F-RWE/ /CRF-RX	450	2021-2022	CR Rouge/Noir	RPRTCRCFRNR1
YAMAHA	YZF	250	2019 > 2022	Noir/YZ Bleu	RPRTYZFNRBL1
	YZ-FX	250	2021 > 2022	Noir/YZ Bleu	RPRTYZFNRBL1
	YZF	450	2018 > 2022	Noir/YZ Bleu	RPRTYZFNRBL1
	YZ-FX	450	2021 > 2022	Noir/YZ Bleu	RPRTYZFNRBL1
	WRF	250	2020 > 2022	Noir/YZ Bleu	RPRTYZFNRBL1
	WRF	450	2019 > 2022	Noir/YZ Bleu	RPRTYZFNRBL1
KTM	SX	125-150	2016 > 2018	Noir/K Orange Noir	RPRTKTMNRAR1 RPRTKTMNR001
	SX	125-150-250	2019 > 2022	Noir/K Orange	RPRTKTMNRAR2
	SXF	250-350-450	2016 > 2018	Noir/K Orange Noir	RPRTKTMNRAR1 RPRTKTMNR001
KTM	SXF	450 FACTORY	2018 > 2022	Noir/K Orange	RPRTKTMNRAR2
	SXF	250-350-450	2019 > 2022	Noir/K Orange	RPRTKTMNRAR2
	SX	250	2017-2018	Noir/K Orange Noir	RPRTKTMNRAR1 RPRTKTMNR001
	XC-W	125-150	2017 > 2019	Noir/K Orange Noir	RPRTKTMNRAR1 RPRTKTMNR001
	EXC/EXCF/ XC-W	250 > 500	2017 > 2019	Noir/K Orange Noir	RPRTKTMNRAR1 RPRTKTMNR001
	EXC/EXCF-F/ XC-W/ XCF-W	150 > 500	2020 > 2022	Noir/K Orange	RPRTKTMNRAR2

BRAND	MODEL	CC	ANNEE	COULEUR	RÉFÉRENCE
	XC/XC-F	250-300- 350-450	2017-2018	Noir/K Orange	RPRTKTMNRAR1
				Noir	RPRTKTMNR001
	XC/XC-F	250-300- 350-450	2019 > 2022	Noir/K Orange	RPRTKTMNRAR2
HVA	TC	125	2016 > 2022	Blanc/Bleu Noir	RPRTKTMNBBL1 RPRTKTMNR001
	TC	250	2017 > 2022	Blanc/Bleu Noir	RPRTKTMNBBL1 RPRTKTMNR001
	TE-FE-TX-FX	125 > 501	2017 > 2022	Blanc/Bleu Noir	RPRTKTMNBBL1 RPRTKTMNR001
	FC	250-350-450	2016 > 2022	Blanc/Bleu Noir	RPRTKTMNBBL1 RPRTKTMNR001
	FC	450 ROCKSTAR	2018 > 2022	Blanc/Noir Blanc/Bleu Noir Blanc	RPRTKTMNBBL1 RPRTKTMNBBL1 RPRTKTMNR001 RPRTKTMNBBL1
	FS	450	2017 > 2022	Anthracite grey/Noir Blanc/Bleu Noir	RPRTKTMGANR1 RPRTKTMNBBL1 RPRTKTMNR001
GAS GAS	MC/MC-F/ EC/EC-F	125-250-300- 350-450	2021-2022	G Rouge/Noir	RPRTKTMRGNR1
				Noir	RPRTKTMNR001
BETA	RR	125 > 480	2020 > 2022	Noir Rouge	RPRTBETR001 RPRTBETR001

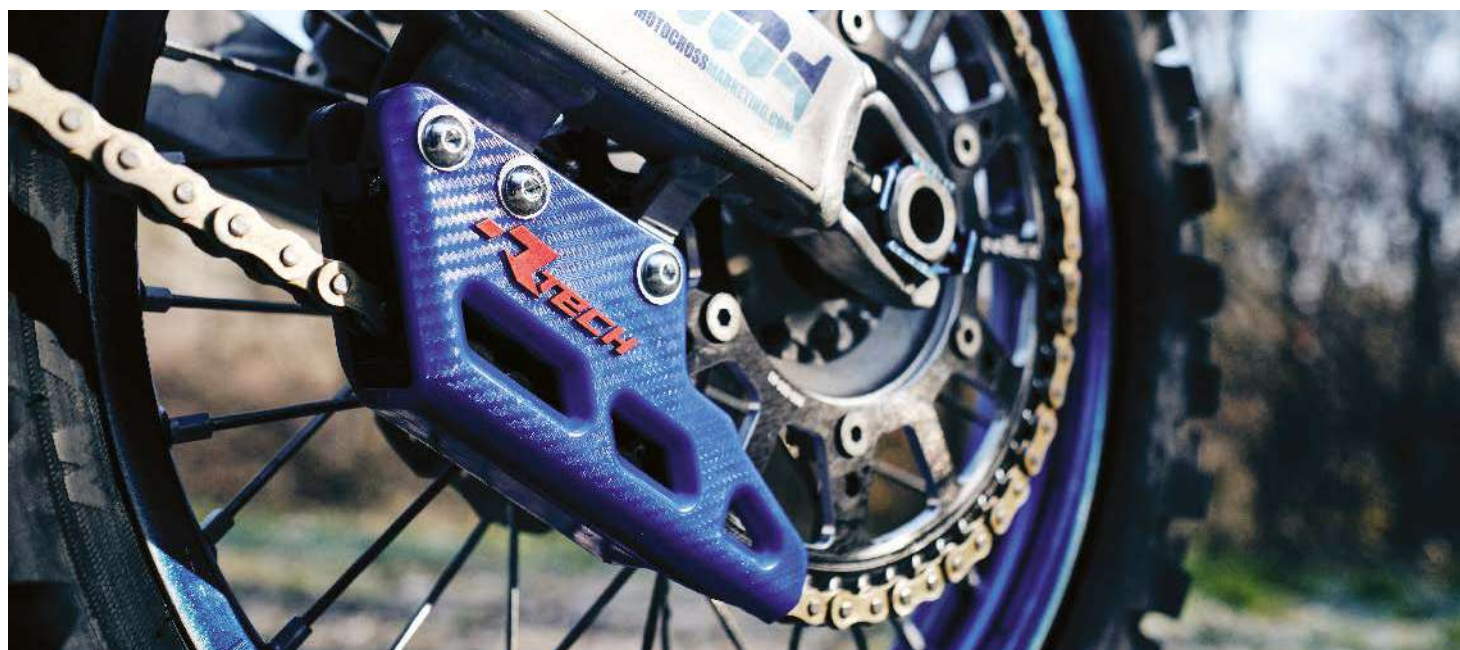

Guide chaîne R2.0 WORX

NOUVEAUTÉ
52,95 € T.T.C.

Nouveau concept guide-chaîne monobloc

Résistance et endurance exceptionnelles grâce au bloc d'usure interne amovible en TPU avec des capacités auto-lubrifiantes

Bagues CNC incluses / Plug et play, ne nécessite pas de modification du support d'origine



BRAND	MODEL	CC	ANNEE	COULEUR	RÉFÉRENCE	PRIX
HONDA	CRF/CRF-RX/CRFX	250 > 450	2007 > 2022	CR Rouge/Noir	RCRUCRFRSNR20	€ 52,95
YAMAHA	YZ/YZF/WRF/YZ-X/	125 > 450	2007 > 2022	YZ Bleu/Noir	RCRUYZFBLNR20	€ 52,95
KAWASAKI	KXF	250-450	2009 > 2022	KX Green/Noir	RCRUKXFVENR20	€ 52,95
	KLX-R	450	2012 > 2016	KX Green/Noir	RCRUKXFVENR20	€ 52,95
KTM	SX/SXF/XC-F	125 > 450	2007 > 2022	Noir/K Orange	RCRUKTMNRR20	€ 52,95
				Blanc/Noir	RCRUKTMBNNR20	
	EXC/EXC-F/XC-W	125 > 500	2008 > 2022	Noir/K Orange	RCRUKTMNRR20	€ 52,95
				Blanc/Noir	RCRUKTMBNNR20	
HUSQVARNA	TC/FC/TE/TX/ FX/FE/FS	125 > 501	2014 > 2022	Blanc/Noir	RCRUKTMBNNR20	€ 52,95
				HSQ Bleu/Noir	RCRUKTMBLNR20	
GAS GAS	EC/EC-F	250-300-350	2018 > 2022	G Rouge/Noir	RCRUKTMRSNR20	€ 52,95
				Blanc/Noir	RCRUKTMBNNR20	
	MC/MC-F	125-250-450	2021-2022	G Rouge/Noir	RCRUKTMRSNR20	€ 52,95
				Blanc/Noir	RCRUKTMBNNR20	
BETA	RR	125 > 530	2013 > 2022	Noir	RCRUBETNR0020	€ 52,95
	XTRAINER	250-300	2015 > 2022	Noir	RCRUBETNR0020	€ 52,95
SHERCO	SE-SEF	125 > 500	2013 > 2022	Blanc/Noir	RCRUKTMBNNR20	€ 52,95
				Noir	RCRUKTMBLNR20	
FANTIC TM	XX / XE / /XXF / XEF	125-250-450	2021-2022	Noir	RCRUYZFNRO020	€ 52,95
	MX / EM / SM	85 > 530	2007 > 2022	Noir	RCRUTMOBLNR21	€ 52,95

Pièce détachée R2.0 WORX

13,95 €
T.T.C.



RPATTNR00020 - Bloc d'usure interne noir

RPATTAR00020 - Bloc d'usure interne orange



D.I.D.[®]

Les chaînes D.I.D

La référence.

D.I.D possède la plus longue expérience qui soit dans l'équipement d'origine.

La chaîne D.I.D X-Ring : leader en matière de chaîne haute performance, pour une friction minimum et une longévité supérieure. Moitié moins de perte de puissance qu'avec une chaîne O-Ring normale.



Supersprox

La pignonnerie a sa couronne

Fondée en 1959, SUPERSPROX est une entreprise qui connaît le marché et vos attentes. Concepteur et fabricant de la désormais célèbre couronne bi-métal « SUPERSPROX STEALTH »

Producteur de première monte

KTM Autriche, Yamaha USA, Husqvarna, Honda-Montesa Japon (pour ne citer qu'eux) ainsi que de nombreux constructeurs européens font confiance à SUPERSPROX



TRANSMISSION

KITS CHÂÎNES /
CHAÎNES /
COURONNES /
PIGNONS /

D.I.D.[®]

Supersprox

AFAM[®]



APPLICATIONS KIT CHÂÎNE	256
SUPERSPROX	278
D.I.D	284
AFAM	290

TRANSMISSION

Cyl	Modèle	Année	CHAÎNE		KIT			PIGNON		COURONNE	
			Pas	Maillons	Matériau	RÉFÉRENCE Racine Qualité Attache	Référence	Nb dents dispos	Référence	Nb dents dispos	
AEON											
50	Cobra / 100 Cobra	00-04	428	78	acier	1010010 1 1	PT112-19	19..21	CX100-28	28,35	
50	Minikolt	00-04	420	58	acier	1010020 0 1	PT113-17	17	CX101-35	35	
50	Revo / 100 Revo	00-04	428	84	acier	1010030 1 1	PT112-19	19..21	CX102-28	24,26,28	
125	- 180 Cobra RS Sp./180 RSII/180 Ut.	00-04	520	70	acier	1010100 5 1	PT114-17	17..21	CC214-32	28,32	
125	Cobra RSII / 180 Overland	00-04	520	72	acier	1010110 5 1	PT114-17	17..21	CC214-32	28,32	
ADLY											
300	Thunderbike	04->	520	86	acier	1014200 5 1	PA313-13	12..14	CX324-32	32	
APRILIA											
125	Tuareg Rally	90-92	520	114	acier	1020130 1 1	PP201-14	12..17	CI204-49	41,42,45,49	
125	Tuareg	86-87	520	104	alu	2020131 1 1	PP301-15	14..16	AX320-42	#ERROR	
350	ETX Tuareg Wind	87-90	520	108	acier	1020101 5 1	PP302-16	16,17	CI304-45	39..47,49	
450	RXV / 550 RXV	06->	520	114	acier	1020300 5 1	PP210-15	14..16	CI400-48	37,40,45,48	
450	SXV / 550 SXV	06->	520	112	alu	2020310 5 1	PP210-15	14..16	AJ400-46	46	
BAROSSA											
150	Magna	-	520	72	acier	1091100 5 2	PA317-14	11..15	CC500-40	40..42,4447..50,52	
170	Baja / Magna	03->	520	92	acier	1091110 5 2	PA317-14	11..15	CC500-40	40..42,4447..50,52	
250	Quarterback	03->	520	94	acier	1091120 5 2	PA317-14	11..15	CC500-40	40..42,4447..50,52	
BETA											
50	RR Enduro Factory	12->	420	132	acier	1013007 0 1	PT119-12	11..15	CJ101-51	51	
125	ALP	98-00	428	136	alu	2021103 1 1	PT202-11	12..14	AU111-55	55,56	
125	ALP	01->	428	136	alu	2021104 1 1	PC201-16	14..16	AU112-60	53,60	
125	Jonathan	03-04	520	122	acier	1013100 5 1	PC303-15	12..15	CI304-44	39..47,49	
125	RR LC 4TPS ENDURO	11-17	428	140	acier	1013102 5 1	PB211-14	13..15	CJ200-63	50,54,56,63	
125	RR	18->	520	114	acier	1013231 5 1	PR301-13	11..16	CA212-50	40,42..53	
125	RR	18->	520	114	alu	2013231 5 1	PR301-13	11..16	AB212-50	40,42..53	
125	RR	18->	520	114	stealth ■	4R13231 5 1	PR301-13	11..16	CA212SR-50	40,42..53	
200	ALP	<-99	520	110	alu	2021106 1 1	PQ201-13	13			
200	ALP 4T	00-03	520	110	alu	2021107 1 1	PC303-12	12..15			
200	RR	19->	520	116	acier	1013232 5 1	PR301-14	11..16	CA212-49	40,42..53	
200	RR	19->	520	116	alu	2013232 5 1	PR301-14	11..16	AB212-49	40,42..53	
200	RR	19->	520	116	stealth ■	4R13232 5 1	PR301-14	11..16	CA212SR-49	40,42..53	
250	RR 2T	13-22	520	114	acier	1013233 5 1	PR301-14	11..16	CA212-49	40,42..53	
250	RR 2T	13-22	520	114	alu	2013233 5 1	PR301-14	11..16	AB212-49	40,42..53	
250	RR 2T	13-22	520	114	stealth ■	4R13233 5 1	PR301-14	11..16	CA212SR-49	40,42..53	
250	/ 300 XTRAINER	19-22	520	114	acier	1013233 5 1	PR301-14	11..16	CA212-49	40,42..53	
250	/ 300 XTRAINER	19-22	520	114	alu	2013233 5 1	PR301-14	11..16	AB212-49	40,42..53	
250	/ 300 XTRAINER	19-22	520	114	stealth ■	4R13233 5 1	PR301-14	11..16	CA212SR-49	40,42..53	
300	RR 2T	13-19	520	114	acier	1013233 5 1	PR301-14	11..16	CA212-49	40,42..53	
300	RR 2T	13-19	520	114	alu	2013233 5 1	PR301-14	11..16	AB212-49	40,42..53	
300	RR 2T	13-19	520	114	stealth ■	4R13233 5 1	PR301-14	11..16	CA212SR-49	40,42..53	
300	RR 2T	20-22	520	114	acier	1013234 5 1	PR301-14	11..16	CA212-48	40,42..53	
300	RR 2T	20-22	520	114	alu	2013234 5 1	PR301-14	11..16	AB212-48	40,42..53	
300	RR 2T	20-22	520	114	stealth ■	4R13234 5 1	PR301-14	11..16	CA212SR-48	40,42..53	
350	Jonathan	01-02	520	120	acier	1021102 5 1	PC303-15	12..15	CI304-42	39..47,49	
350	Jonathan	03-06	520	122	acier	1013200 5 1	PC303-15	12..15	CI304-44	39..47,49	
350	RR	12-12	520	114	acier	1013220 5 1	PR301-13	11..16	CE206-50	40..53	
350	RR	12-12	520	114	alu	2013220 5 1	PR301-13	11..16	AF206-50	39,41..53	
350	RR	13-19	520	114	acier	1013231 5 1	PR301-13	11..16	CA212-50	40,42..53	
350	RR	13-19	520	114	alu	2013231 5 1	PR301-13	11..16	AB212-50	40,42..53	
350	RR	13-19	520	114	stealth ■	4R13231 5 1	PR301-13	11..16	CA212SR-50	40,42..53	
350	RR	20-22	520	116	acier	1013235 5 1	PR301-13	11..16	CA212-50	40,42..53	
350	RR	20-22	520	116	alu	2013235 5 1	PR301-13	11..16	AB212-50	40,42..53	
350	RR	20-22	520	116	stealth ■	4R13235 5 1	PR301-13	11..16	CA212SR-50	40,42..53	
390	RR	13-19	520	114	acier	1013230 5 1	PR301-13	11..16	CA212-49	40,42..53	
390	RR	13-19	520	114	alu	2013230 5 1	PR301-13	11..16	AB212-49	40,42..53	
390	RR	13-19	520	114	stealth ■	4R13230 5 1	PR301-13	11..16	CA212SR-49	40,42..53	
390	RR	20-22	520	116	acier	1013236 5 1	PR301-13	11..16	CA212-49	40,42..53	
390	RR	20-22	520	116	alu	2013236 5 1	PR301-13	11..16	AB212-49	40,42..53	
390	RR	20-22	520	116	stealth ■	4R13236 5 1	PR301-13	11..16	CA212SR-49	40,42..53	



Cyl	Modèle	Année	CHAÎNE		KIT			PIGNON		COURONNE	
			Pas	Maillons	Matériau	RÉFÉRENCE Racine Qualité Attache	Référence	Nb dents dispos	Référence	Nb dents dispos	
400	450 / 525 RR	05-09	520	114	alu	2013300 5 1	PR301-14	11..16	AF206-50	39,41..53	
430	450 / 480 / 498 / 520 RR	13-19	520	112	acier	1013330 5 1	PR301-13	11..16	CA212-48	40,42..53	
430	450 / 480 / 498 / 520 RR	13-19	520	112	alu	2013330 5 1	PR301-13	11..16	AB212-48	40,42..53	
430	450 / 480 / 498 / 520 RR	13-19	520	112	stealth ■	4R13330 5 1	PR301-13	11..16	CA212SR-48	40,42..53	
430	RR	20-22	520	116	acier	1013236 5 1	PR301-13	11..16	CA212-49	40,42..53	
430	RR	20-22	520	116	alu	2013236 5 1	PR301-13	11..16	AB212-49	40,42..53	
430	RR	20-22	520	116	stealth ■	4R13236 5 1	PR301-13	11..16	CA212SR-49	40,42..53	
480	RR	20-22	520	116	acier	1013236 5 1	PR301-13	11..16	CA212-49	40,42..53	
480	RR	20-22	520	116	alu	2013236 5 1	PR301-13	11..16	AB212-49	40,42..53	
480	RR	20-22	520	116	stealth ■	4R13236 5 1	PR301-13	11..16	CA212SR-49	40,42..53	
BMW											
450	G X	08->	520	114	acier	1020220 5 1	PP303-15	15	CI309-48	48	
450	G X	08->	520	114	alu	2020220 5 1	PP303-15	15	AJ308-48	48	
650	Xchallenge/Xcountry	07->	520	112	acier	1020360 6 2	PP301-15	14..16	CX503-47	47	
650	Xchallenge/Xcountry	07->	520	112	alu	2020360 6 2	PP301-15	14..16	AJ307-47	47,52	
650	Xmoto	07->	520	112	acier	10203616 2	PP301-16	14..16	CI801-47	44,47	
BOMBARDIER											
650	Desert Storm	99->	530	112	acier	1055100 6 1	PT710-16	16	CX710-36	36,40	
650	Desert Storm	04->	530	112	acier	10551016 1	PT710-16	16	CX711-40	36,40	
DINLI											
50	Dino	00-04	428	58	acier	1012000 1 1	PM300-13	13..16	CK300-36	36	
50	- 100 Helix / T Rex	00-04	428	90	acier	1012010 1 1	PM300-13	13..16	CJ301-32	32	
ETON											
40	IXL Pascal / JXL Viper Junior	-	420	78	acier	1090530 0 1	PM102-14	14,19	CK105-36	36	
50	AXL-NXL Lightning/RXL Viper/TXL	-	420	78	acier	10905310 1	PM102-19	14,19	CK106-28	22,24,28,34	
50	BXL-DXL / 90 AXL-DXL-NXL-RXL-TXL	-	520	48	acier	1090532 1 1	PA201-15	12,13,15	CK400-28	22,28	
150	CXL Challenger / YXL Yukon	-	520	78	acier	1090540 5 1	PM400-12	12,15..17	CK401-34	34	
150	EXL Yukon	-	520	80	acier	10905415 1	PM400-15	12,15..17	CK401-34	34	
FANTIC											
125	XE	21->	520	114	acier	10511415 1	PB309-13	12..15	CA304-50	38..53	
125	XE	21->	520	114	alu	20811415 1	PB309-13	12..15	AD323-50	45..54	
125	XE	21->	520	114	stealth ■	4R511415 1	PB309-13	12..15	CA304SR-50	38..53	
125	XX	21->	520	112	acier	1051109 2 1	PB309-13	12..15	CA304-48	38..53	
125	XX	21->	520	112	alu	2081109 2 1	PB309-13	12..15	AD323-48	45..54	
125	XX	21->	520	112	stealth ■	4R51109 2 1	PB309-13	12..15	CA304SR-48	38..53	
250	XEF	21->	520	114	acier	1051162 5 1	PB309-13	12..15	CA304-51	38..53	
250	XEF	21->	520	114	alu	2081162 5 1	PB309-13	12..15	AD323-51	45..54	
250	XEF	21->	520	114	stealth ■	4R51162 5 1	PB309-13	12..15	CA304SR-51	38..53	
250	XEF	21->	520	114	stealth ■	4G51162 5 1	PB309-13	12..15	CA304SG-51	38..53	
250	XX	22->	520	114	acier	1051139 2 1	PH500-14	13..17	CA304-50	38..53	
250	XX	22->	520	114	alu	2081139 2 1	PH500-14	13..17	AD323-50	45..54	
250	XX	22->	520	114	stealth ■	4R51139 2 1	PH500-14	13..17	CA304SR-50	38..53	
250	XX	22->	520	114	stealth ■	4G51139 2 1	PH500-14	13..17	CA304SG-50	38..53	
250	XXF	22->	520	114	acier	1051164 2 1	PB309-13	12..15	CA304-50	38..53	
250	XXF	22->	520	114	alu	2081164 2 1	PB309-13	12..15	AD323-50	45..54	
250	XXF	22->	520	114	stealth ■	4R51164 2 1	PB309-13	12..15	CA304SR-50	38..53	
250	XXF	22->	520	114	stealth ■	4G51164 2 1	PB309-13	12..15	CA304SG-50	38..53	
450	XEF	22->	520	114	acier	1051178 5 1	PH500-13	13..17	CA304-50	38..53	
450	XEF	22->	520	114	alu	2081178 5 1	PH500-13	13..17	AD323-50	45..54	
450	XEF	22->	520	114	stealth ■	4R51178 5 1	PH500-13	13..17	CA304SR-50	38..53	
450	XEF	22->	520	114	stealth ■	4G51178 5 1	PH500-13	13..17	CA304SG-50	38..53	
450	XXF	22->	520	114	acier	1051192 2 1	PH500-13	13..17	CA304-49	38..53	
450	XXF	22->	520	114	alu	2081192 2 1	PH500-13	13..17	AD323-49	45..54	
450	XXF	22->	520	114	stealth ■	4R51192 2 1	PH500-13	13..17	CA304SR-49	38..53	
450	XXF	22->	520	114	stealth ■	4G51192 2 1	PH500-13	13..17	CA304SG-49	38..53	
GAS GAS											
50	MC	21->	415	104	alu	2072004 2 1	PT122-11	9..11	AP103-40	40.. 42	
50	Rookie SM / EC	01-05	420	130	acier	1093000 0 1	PO102-12	10..14	CK103-53	44..48,50,52,53,58,62,65	
65	MC	21->	420	112	acier	1071005 2 1	PT120-14	12..14	CO10148	46,48,50	
65	MC	21->	420	112	alu	2072005 2 1	PT120-14	12..14	AP101-48	46,48,50	

TRANSMISSION

Cyl	Modèle	Année	CHAÎNE		KIT			PIGNON		COURONNE	
			Pas	Maillons	Matériau	RÉFÉRENCE Racine Qualité Attache	Référence	Nb dents dispos	Référence	Nb dents dispos	
GAS GAS											
65	MC	21->	420	112	stealth■	4G710052 1	PT120-14	12..14	CO101SG-48	46,48,50	
85	MC P.R. 17/14	22->	428	122	acier	10710542 1	PT202-13	12..14	CO20046	46,49	
85	MC P.R. 17/14	22->	428	122	alu	20720542 1	PT202-13	12..14	AP102-46	46.. 50	
85	MC P.R. 17/14	22->	428	122	stealth■	4G710542 1	PT202-13	12..14	CO200SG-46	46,49	
85	MC G.R. 19/16	18->	428	124	acier	10710552 1	PT202-13	12..14	CO20049	46,49	
85	MC G.R. 19/16	18->	428	124	alu	20720552 1	PT202-13	12..14	AP102-49	46.. 50	
85	MC G.R. 19/16	18->	428	124	stealth■	4G710552 1	PT202-13	12..14	CO200SG-49	46,49	
85	MC G.R. 19/16	18->	428	124	stealth■	4N710552 1	PT202-13	12..14	CO200SN-49	46,49	
125	JT12 / TX	92-99	520	102	alu	2093211 1	PT305-11	10..12	AU303-44	40..4244	
125	EC Enduro	97-00	520	118	alu	20931045 1	PT313-13	12,13	AF206-52	39,41..53	
125	EC Enduro	01-13	520	114	acier	10931055 1	PB203-13	12..14	CE206-48	40..53	
125	EC Enduro	01-13	520	114	alu	20931055 1	PB203-13	12..14	AF206-48	39,41..53	
125	EC Racing	13-15	520	114	acier	10931065 1	PB203-12	12..14	CE206-50	40..53	
125	EC Racing	13-15	520	114	alu	20931065 1	PB203-12	12..14	AF206-50	39,41..53	
125	MC	02-02	520	116	alu	20931102 1	PB203-13	12..14	AF206-51	39,41..53	
125	MC	03-04	520	114	alu	20931112 1	PB203-13	12..14	AF206-48	39,41..53	
125	MC	20->	520	118	acier	10713022 1	PR301-13	11..16	CO304-51	38,40..53	
125	MC	20->	520	118	alu	20723022 1	PR301-13	11..16	AP304-51	36..40,42..54	
125	MC	20->	520	118	stealth■	4R713022 1	PR301-13	11..16	CO304SR-51	38,40..53	
125	MC	20->	520	118	stealth■	4G713022 1	PR301-13	11..16	CO304SG-51	38,40..53	
125	Pampera	92-01	520	100	alu	20931072 1	PT305-10	10..12	AU303-44	40..4244	
125	TXT	<-00	520	102	alu	20931062 1	PT305-10	10..12	AU303-44	40..4244	
125	TXT	00-01	520	114	alu	20931072 1	PT305-10	10..12	AU303-44	40..4244	
125	TXT	02-03	520	104	alu	20931082 1	PW200-09	9..11	AU320-44	42..44,46	
125	TXT Pro	04-04	520	102	alu	20932202 1	PW200-09	9..11	AU320-44	42..44,46	
125	TXT Pro	05->	520	102	alu	20932212 1	PW200-11	9..11	AU320-42	42..44,46	
160	JT16 Trial	-	520	102	alu	20932110 1	PT305-11	10..12	AU303-44	40..4244	
200	EC Enduro	00-02	520	116	alu	20932105 1	PT313-13	12,13	AF206-51	39,41..53	
200	EC Enduro	03-13	520	114	acier	10932525 1	PT313-13	12,13	CE206-48	40..53	
200	EC Enduro / Ranger	03-13	520	114	alu	20932525 1	PT313-13	12,13	AF206-48	39,41..53	
200	EC Enduro / Ranger	17-20	520	114	acier	10932575 1	PT313-12	12,13	CE206-50	40..53	
200	EC Enduro / Ranger	17-20	520	114	alu	20932575 1	PT313-12	12,13	AF206-50	39,41..53	
200	EC Enduro	17-20	520	114	stealth■	4R932575 1	PT313-12	12,13	CE206SR-50	40..53	
200	TXT	02-03	520	104	alu	20932302 1	PW200-10	9..11	AU320-44	42..44,46	
240	TX270 / TXT 249	95-98	520	104	alu	2093253 1	PT305-11	10..12	AU303-41	40..4244	
270	TX270	99->	520	104	alu	2093253 1	PT305-11	10..12	AU303-41	40..4244	
250	Enduro	96-96	520	116	acier	10932505 1	PT312-13	13	CE206-49	40..53	
250	Enduro	96-96	520	116	alu	20932505 1	PT312-13	13	AF206-49	39,41..53	
250	Enduro	97-00	520	116	alu	20932515 1	PT313-13	12,13	AF206-47	39,41..53	
250	EC Enduro	01-16	520	114	acier	10932525 1	PT313-13	12,13	CE206-48	40..53	
250	EC Enduro	01-16	520	114	alu	20932525 1	PT313-13	12,13	AF206-48	39,41..53	
250	EC Enduro	01-16	520	114	stealth■	4R932525 1	PT313-13	12,13	CE206SR-48	40..53	
250	EC Enduro	18-20	520	114	acier	10932585 1	PT313-13	12,13	CE206-49	40..53	
250	EC Enduro	18-20	520	114	alu	20932585 1	PT313-13	12,13	AF206-49	39,41..53	
250	EC Enduro	18-20	520	114	stealth■	4R932585 1	PT313-13	12,13	CE206SR-49	40..53	
250	EC	21->	520	118	acier	10717075 1	PR301-13	11..16	CO304-52	38,40..53	
250	EC	21->	520	118	alu	20727075 1	PR301-13	11..16	AP304-52	36..40,42..54	
250	EC	21->	520	118	stealth■	4R717075 1	PR301-13	11..16	CO304SR-52	38,40..53	
250	EC	21->	520	118	stealth■	4G717075 1	PR301-13	11..16	CO304SG-52	38,40..53	
250	EC-F 4T Enduro	10-13	520	116	acier	10932565 1	PB309-13	12..15	CE206-50	40..53	
250	EC-F 4T Enduro	10-13	520	116	alu	20932565 1	PB309-13	12..15	AF206-50	39,41..53	
250	EC-F	21->	520	118	acier	10717075 1	PR301-13	11..16	CO304-52	38,40..53	
250	EC-F	21->	520	118	alu	20727075 1	PR301-13	11..16	AP304-52	36..40,42..54	
250	EC-F	21->	520	118	stealth■	4R717075 1	PR301-13	11..16	CO304SR-52	38,40..53	
250	EC-F	21->	520	118	stealth■	4G717075 1	PR301-13	11..16	CO304SG-52	38,40..53	
250	MC	02-	520	116	alu	20932602 1	PT313-13	12,13	AF206-51	39,41..53	
250	MC	03-04	520	114	acier	10932632 1	PT313-12	12,13	CE206-48	40..53	
250	MC	03-04	520	114	alu	20932632 1	PT313-12	12,13	AF206-48	39,41..53	
250	MC	22->	520	116	acier	10717122 1	PR301-14	11..16	CO304-49	38,40..53	



Cyl	Modèle	Année	CHAÎNE		KIT			PIGNON		COURONNE	
			Pas	Maillons	Matériau	RÉFÉRENCE Racine Qualité Attache	Référence	Nb dents dispos	Référence	Nb dents dispos	
250	MC	22->	520	116	alu	2072712 2 1	PR301-14	11..16	AP304-49	36..40,42..54	
250	MC	22->	520	116	stealth ■	4R71712 2 1	PR301-14	11..16	CO304SR-49	38,40..53	
250	MC	22->	520	116	stealth ■	4G71712 2 1	PR301-14	11..16	CO304SG-49	38,40..53	
250	MC-F	21->	520	118	acier	1071301 2 1	PR301-14	11..16	CO304-51	38,40..53	
250	MC-F	21->	520	118	alu	2072301 2 1	PR301-14	11..16	AP304-51	36..40,42..54	
250	MC-F	21->	520	118	stealth ■	4R71301 2 1	PR301-14	11..16	CO304SR-51	38,40..53	
250	MC-F	21->	520	118	stealth ■	4G71301 2 1	PR301-14	11..16	CO304SG-51	38,40..53	
250	Pampera	99-01	520	102	alu	2093262 2 1	PT305-12	10..12	AU303-40	40..4244	
250	TX320 / TXT 321	99->	520	104	alu	2093253 2 1	PT305-11	10..12	AU303-41	40..4244	
250	TXT / 280 TXT Pro / 300TXT	02-04	520	102	alu	2093264 2 1	PW200-11	9..11	AU320-44	42..44,46	
250	- 300 Wild Quad 2T / 400	03->	520	96	acier	1093281 5 1	PT313-13	12,13	CG500-41	38...47	
280	TXT	00-01	520	100	alu	2093261 2 1	PT305-11	10..12	AU303-41	40..4244	
300	Enduro	99-99	520	114	alu	2093254 5 1	PT313-13	12,13	AF206-47	39,41..53	
300	EC Enduro / Ranger	00-20	520	114	acier	1093252 5 1	PT313-13	12,13	CE206-48	40..53	
300	EC Enduro / Ranger	00-20	520	114	alu	2093252 5 1	PT313-13	12,13	AF206-48	39,41..53	
300	EC Enduro / Ranger	00-20	520	114	stealth ■	4R93252 5 1	PT313-13	12,13	CE206SR-48	40..53	
300	EC	21->	520	116	acier	1071702 5 1	PR301-13	11..16	CO304-50	38,40..53	
300	EC	21->	520	116	alu	2072702 5 1	PR301-13	11..16	AP304-50	36..40,42..54	
300	EC	21->	520	116	stealth ■	4R71702 5 1	PR301-13	11..16	CO304SR-50	38,40..53	
300	EC	21->	520	116	stealth ■	4G71702 5 1	PR301-13	11..16	CO304SG-50	38,40..53	
300	EC-F 4T Enduro	10-15	520	116	acier	1093256 5 1	PB309-13	12..15	CE206-50	40..53	
300	EC-F 4T Enduro	10-15	520	116	alu	2093256 5 1	PB309-13	12..15	AF206-50	39,41..53	
350	EC-F	21->	520	116	acier	1071707 5 1	PR301-13	11..16	CO304-52	38,40..53	
350	EC-F	21->	520	116	alu	2072707 5 1	PR301-13	11..16	AP304-52	36..40,42..54	
350	EC-F	21->	520	116	stealth ■	4R71707 5 1	PR301-13	11..16	CO304SO-52	38,40..53	
350	EC-F	21->	520	116	stealth ■	4G71707 5 1	PR301-13	11..16	CO304SG-52	38,40..53	
350	MC-F	22->	520	118	acier	1071301 2 1	PR301-14	11..16	CO304-51	38,40..53	
350	MC-F	22->	520	118	alu	2072301 2 1	PR301-14	11..16	AP304-51	36..40,42..54	
350	MC-F	22->	520	118	stealth ■	4R71301 2 1	PR301-14	11..16	CO304SR-51	38,40..53	
350	MC-F	22->	520	118	stealth ■	4G71301 2 1	PR301-14	11..16	CO304SG-51	38,40..53	
400	EC FSE / EC450 FSE / EC450-F	02-13	520	116	acier	1093300 5 1	PT313-13	12,13	CE206-48	40..53	
400	EC FSE / EC450 FSE / EC450-F	02-13	520	116	alu	2093300 5 1	PT313-13	12,13	AF206-48	39,41..53	
450	MC-F	21->	520	118	alu	1071303 2 1	PR301-13	11..16	CO304-49	38,40..53	
450	MC-F	21->	520	118	alu	2072303 2 1	PR301-13	11..16	AP304-49	36..40,42..54	
450	MC-F	21->	520	118	stealth ■	4R71303 2 1	PR301-13	11..16	CO304SR-49	38,40..53	
450	MC-F	21->	520	118	stealth ■	4G71303 2 1	PR301-13	11..16	CO304SG-49	38,40..53	
450	Wild 4T	04-05	520	96	acier	1093281 5 1	PT313-13	12,13	CG500-41	38...47	
HM											
50	Enduro	02-02	420	138	acier	1041051 2 1	PT119-12	11..15	CO104-56	50,56	
50	CRE RR	07-17	420	138	acier	1041060 0 1	PT119-11	11..15	CK103-58	44..48,50,52,53,58,62,65	
50	Dérapiage	03->	420	138	acier	1041060 0 1	PT119-11	11..15	CK103-58	44..48,50,52,53,58,62,65	
50	Dérapiage Compétition	09->	420	140	acier	1041061 0 1	PT119-14	11..15	CK103-58	44..48,50,52,53,58,62,65	
125	CRE R 3	03-03	520	116	acier	1041100 5 1	PA206-13	12..14	CA212-49	40,42..53	
125	CRE R 3	03-03	520	116	alu	2041100 5 1	PA206-13	12..14	AB212-49	40,42..53	
125	CRE R 4	04-04	520	116	acier	1041101 5 1	PA208-13	12..14	CA212-49	40,42..53	
125	CRE R 4	04-04	520	116	alu	2041101 5 1	PA208-13	12..14	AB212-49	40,42..53	
125	CRE RR 2T	11->	520	114	acier	1041103 5 1	PP201-16	12..17	CE206-50	40..53	
230	CRF Easy 4	04-04	520	110	acier	1041200 5 1	PA305-13	12..15	CA212-50	40,42..53	
250	CRE R 3	03-03	520	112	acier	1041300 5 1	PA311-13	13..16	CA212-47	40,42..53	
250	CRE R 3	03-03	520	112	alu	2041300 5 1	PA311-13	13..16	AB212-47	40,42..53	
250	CRE R 4	04-04	520	116	acier	1041301 5 1	PA311-13	13..16	CA212-47	40,42..53	
250	CRE R 4	04-04	520	116	alu	2041301 5 1	PA311-13	13..16	AB212-47	40,42..53	
250	CRE F 4T	04-04	520	116	acier	1041101 5 1	PA208-13	12..14	CA212-49	40,42..53	
250	CRE F 4T	04-04	520	116	alu	2041101 5 1	PA208-13	12..14	AB212-47	40,42..53	
450	CRE F 3	03-03	520	114	acier	1040131 5 1	PA311-13	13..16	CA212-48	40,42..53	
450	CRE F 3	03-03	520	114	alu	2080131 5 1	PA311-13	13..16	AB212-48	40,42..53	
450	CRE F 4	04-04	520	114	acier	1040130 5 1	PA311-13	13..16	CA212-50	40,42..53	
450	CRE F 4	04-04	520	114	alu	2080130 5 1	PA311-13	13..16	AB212-50	40,42..53	

TRANSMISSION

Cyl	Modèle	Année	CHAÎNE		KIT			PIGNON		COURONNE	
			Pas	Maillons	Matériau	RÉFÉRENCE Racine Qualité Attache	Référence	Nb dents dispos	Référence	Nb dents dispos	
HONDA											
50	CRF	04-20	420	78	acier	10400152 1	PA105-14	13..16	CA113-37	37	
50	XR	00-03	420	118	acier	10400250 1	PA105-14	13..16	CA113-37	37	
70	CRF	04->	420	86	acier	10400172 1	PA105-15	13..16	CA101-36	36,38,45..47,49,51	
70	TRX	86-87	420	72	acier	10400180 1	PA110-13	12..15	CA106-36	33,35..36,38,40..43	
70	XR R	<-99	420	86	acier	10400272 1	PA101-15	13..17	CA101-36	36,38,45..47,49,51	
70	XR R	00->	420	86	acier	10400282 1	PA105-15	13..16	CA101-36	36,38,45..47,49,51	
80	CR (petites roues)	87-95	420	114	alu	20800502 1	PA105-15	13..16	AB104-49	48..52,55..56	
80	CR (petites roues)	96->	420	118	alu	20800512 1	PA105-15	13..16	AB104-49	48..52,55..56	
80	CR (petites roues) #428	96->	428	118	alu	20800582 1	PA108-15	15	AB111-49	49..50,52,54..56	
80	CR (grandes roues) #420	96-02	420	126	alu	20800592 1	PA105-15	13..16	AB104-55	48..52,55..56	
80	CR (grandes roues)	96-02	428	126	alu	20800522 1	PA108-15	15	AB111-55	49..50,52,54..56	
80	CR (grandes roues)	03->	428	126	alu	20800602 1	PA105-15	13..16	AB104-55	48..52,55..56	
80	CRF	04->	420	110	acier	10400402 1	PA101-14	13..17	CA101-46	36,38,45..47,49,51	
80	XR R	91->	420	110	acier	10400402 1	PA101-14	13..17	CA101-46	36,38,45..47,49,51	
85	CR R G.R.	03-04	420	124	alu	20800412 1	PA105-15	13..16	AB104-56	48..52,55..56	
85	CR R G.R. >428<	03-04	428	124	alu	20800422 1	PA108-15	15	AB111-56	49..50,52,54..56	
85	CR R G.R.	05-07	420	124	acier	10400942 1	PA105-15	13..16	CA104-55	46,47,49,50,51,55,56	
85	CR R G.R.	05-07	420	124	alu	20800942 1	PA105-15	13..16	AB104-55	48..52,55..56	
90	TRX Fourtrax	93-04	428	98	acier	1040030 1 1	PA104-13	12..15	CA112-50	48,50	
100	CRF	04-12	428	118	acier	10400312 1	PA107-14	13..15	CA110-50	46,49,50	
100	XR R	85-07	428	118	acier	10400312 1	PA107-14	13..15	CA110-50	46,49,50	
110	CRF	13-18	420	86	acier	10400042 1	PA104-14	12..15	CA101-38	36,38,45..47,49,51	
125	CR	87-96	520	114	acier	10400972 1	PA206-13	12..14	CA212-51	40,42..53	
125	CR	87-96	520	114	alu	20801002 1	PA206-13	12..14	AB212-51	40,42..53	
125	CR	97-97	520	112	acier	10401012 1	PA206-12	12..14	CA212-49	40,42..53	
125	CR	97-97	520	112	alu	20801012 1	PA206-12	12..14	AB212-49	40,42..53	
125	CR	98-99	520	114	acier	10400972 1	PA206-13	12..14	CA212-51	40,42..53	
125	CR	98-99	520	114	alu	20801002 1	PA206-13	12..14	AB212-51	40,42..53	
125	CR	00-01	520	116	acier	10400982 1	PA206-13	12..14	CA212-52	40,42..53	
125	CR	00-01	520	116	alu	20801022 1	PA206-13	12..14	AB212-52	40,42..53	
125	CR	02-02	520	114	acier	10400972 1	PA206-13	12..14	CA212-51	40,42..53	
125	CR	02-02	520	114	alu	20801002 1	PA206-13	12..14	AB212-51	40,42..53	
125	CR	03-03	520	116	acier	10400982 1	PA206-13	12..14	CA212-52	40,42..53	
125	CR	03-03	520	116	alu	20801022 1	PA206-13	12..14	AB212-52	40,42..53	
125	CR	04-07	520	116	acier	10401042 1	PA208-13	12..14	CA212-52	40,42..53	
125	CR	04-07	520	116	alu	20801042 1	PA208-13	12..14	AB212-52	40,42..53	
125	CRF-F	14-16	428	112	acier	1040129 5 1	PP202-13	13,14	CA110-46	46,49,50	
125	CRF-F	17-18	428	118	acier	1040158 5 1	PP202-13	13,14	CA110-49	46,49,50	
150	CRF R P.R.	07-15	420	120	alu	20801072 1	PA211-15	14,15	AB104-50	48..52,55..56	
150	CRF RB G.R.	07-15	420	126	alu	20801082 1	PA211-15	14,15	AB104-55	48..52,55..56	
230	CRF	04->	520	114	alu	20801242 1	PA305-13	12..15	AB212-50	40,42..53	
250	CR	88-89	520	116	alu	20801102 1	PA311-14	13..16	AB212-51	40,42..53	
250	CR	90-91	520	116	alu	20801112 1	PA311-14	13..16	AB212-53	40,42..53	
250	CR	92-93	520	112	alu	20801122 1	PA311-13	13..16	AB212-49	40,42..53	
250	CR	94-95	520	114	alu	20801132 1	PA311-13	13..16	AB212-49	40,42..53	
250	CR	96-01	520	114	acier	10401302 1	PA311-13	13..16	CA212-50	40,42..53	
250	CR	96-01	520	114	alu	20801302 1	PA311-13	13..16	AB212-50	40,42..53	
250	CR	02-03	520	114	acier	10401192 1	PA311-14	13..16	CA212-48	40,42..53	
250	CR	02-03	520	114	alu	20801192 1	PA311-14	13..16	AB212-48	40,42..53	
250	CR	04-05	520	114	acier	10401302 1	PA311-13	13..16	CA212-50	40,42..53	
250	CR	04-05	520	114	alu	20801302 1	PA311-13	13..16	AB212-50	40,42..53	
250	CR	06-07	520	116	acier	10401222 1	PA311-13	13..16	CA212-49	40,42..53	
250	CR	06-07	520	116	alu	20801222 1	PA311-13	13..16	AB212-49	40,42..53	
250	CRF R	04-09	520	114	acier	10401172 1	PA208-13	12..14	CA212-51	40,42..53	
250	CRF R	04-09	520	114	alu	20801172 1	PA208-13	12..14	AB212-51	40,42..53	
250	CRF R	10-10	520	116	acier	10401262 1	PA208-13	12..14	CA212-48	40,42..53	
250	CRF R	10-10	520	116	alu	20801262 1	PA208-13	12..14	AB212-48	40,42..53	
250	CRF R	10-10	520	116	stealth ■	4R401262 1	PA208-13	12..14	CA212SR-48	40,42..53	
250	CRF R	10-10	520	116	stealth ■	4N401262 1	PA208-13	12..14	CA212SN-48	40,42..53	



Cyl	Modèle	Année	CHAÎNE		KIT			PIGNON		COURONNE	
			Pas	Maillons	Matériau	RÉFÉRENCE Racine Qualité Attache	Référence	Nb dents dispos	Référence	Nb dents dispos	
250	CRF R	11-17	520	116	acier	1040127 2 1	PA208-13	12..14	CA212-49	40,42..53	
250	CRF R	11-17	520	116	alu	2080127 2 1	PA208-13	12..14	AB212-49	40,42..53	
250	CRF R	11-17	520	116	stealth ■	4R40127 2 1	PA208-13	12..14	CA212SR-49	40,42..53	
250	CRF R	11-17	520	116	stealth ■	4N40127 2 1	PA208-13	12..14	CA212SN-49	40,42..53	
250	CRF R	18->	520	114	acier	1040163 2 1	PA209-13	13,14	CA212-49	40,42..53	
250	CRF R	18->	520	114	alu	2080163 2 1	PA209-13	13,14	AB212-49	40,42..53	
250	CRF R	18->	520	114	stealth ■	4R40163 2 1	PA209-13	13,14	CA212SR-49	40,42..53	
250	CRF R	18->	520	114	stealth ■	4N40163 2 1	PA209-13	13,14	CA212SN-49	40,42..53	
250	CRF RX	20->	520	114	acier	1040163 2 1	PA209-13	13,14	CA212-49	40,42..53	
250	CRF RX	20->	520	114	alu	2080163 2 1	PA209-13	13,14	AB212-49	40,42..53	
250	CRF RX	20->	520	114	stealth ■	4R40163 2 1	PA209-13	13,14	CA212SR-49	40,42..53	
250	CRF RX	20->	520	114	stealth ■	4N40163 2 1	PA209-13	13,14	CA212SN-49	40,42..53	
250	CRF X	04-15	520	118	acier	1040116 5 1	PA208-14	12..14	CA212-53	40,42..53	
250	CRF X	04-15	520	118	alu	2080116 5 1	PA208-14	12..14	AB212-53	40,42..53	
250	TRX R	86-89	520	96	acier	1040140 5 1	PA308-13	13..15	CA318-39	36,38..40	
250	TRX R - TRX X / 300 TRX Sportrax EX	87-92	520	86	acier	1040142 5 1	PA308-13	13..15	CA318-38	36,38..40	
250	XR R	90-95	520	108	acier	1040180 5 1	PA305-13	12..15	CA212-48	40,42..53	
250	XR R	90-95	520	108	alu	2080180 5 1	PA305-13	12..15	AB212-48	40,42..53	
250	XR R	96->	520	106	acier	1040181 5 1	PA320-13	12,13	CA212-48	40,42..53	
250	XR R	96->	520	106	alu	2080181 5 1	PA320-13	12,13	AB212-48	40,42..53	
300	CRF RX	21->	520	114	acier	1040163 2 1	PA209-13	13,14	CA212-49	40,42..53	
300	CRF RX	21->	520	114	alu	2080163 2 1	PA209-13	13,14	AB212-49	40,42..53	
300	CRF RX	21->	520	114	stealth ■	4R40163 2 1	PA209-13	13,14	CA212SR-49	40,42..53	
300	CRF RX	21->	520	114	stealth ■	4N40163 2 1	PA209-13	13,14	CA212SN-49	40,42..53	
400	CRF-RX	21->	520	114	acier	1040130 5 1	PA311-13	13..16	CA212-50	40,42..53	
400	CRF-RX	21->	520	114	alu	2080130 5 1	PA311-13	13..16	AB212-50	40,42..53	
400	CRF-RX	21->	520	114	stealth ■	4R40130 5 1	PA311-13	13..16	CA212SR-50	40,42..53	
400	CRF-RX	21->	520	114	stealth ■	4N40130 5 1	PA311-13	13..16	CA212SN-50	40,42..53	
400	TRX EX / EX Sportrax	99-04	520	94	acier	1040313 5 2	PA314-15	13..15	CA318-38	36,38..40	
400	TRX EX / EX Sportrax / X	05-14	520	94	acier	1040314 5 2	PA510-14	13..16	CA318-39	36,38..40	
400	XR R	96-05	520	108	acier	1040359 5 1	PA314-15	13..15	CA212-45	40,42..53	
400	XR R	96-05	520	108	alu	2080359 5 1	PA314-15	13..15	AB212-45	40,42..53	
450	CRF-L	19->	520	116	acier	1040171 5 1	PA312-13	13	CA212-51	40,42..53	
450	CRF-L	19->	520	116	alu	2080171 5 1	PA312-13	13	AB212-51	40,42..53	
450	CRF-R	02-03	520	114	acier	1040130 2 1	PA311-13	13..16	CA212-50	40,42..53	
450	CRF-R	02-03	520	114	alu	2080130 2 1	PA311-13	13..16	AB212-50	40,42..53	
450	CRF-R	04-08	520	114	acier	1040131 2 1	PA311-13	13..16	CA212-48	40,42..53	
450	CRF-R	04-08	520	114	alu	2080131 2 1	PA311-13	13..16	AB212-48	40,42..53	
450	CRF-R	09-16	520	116	acier	1040132 2 1	PA311-13	13..16	CA212-48	40,42..53	
450	CRF-R	09-16	520	116	alu	2080132 2 1	PA311-13	13..16	AB212-48	40,42..53	
450	CRF-R	09-16	520	116	stealth ■	4R40132 2 1	PA311-13	13..16	CA212SR-48	40,42..53	
450	CRF-R	09-16	520	116	stealth ■	4N40132 2 1	PA311-13	13..16	CA212SN-48	40,42..53	
450	CRF-R	17->	520	114	acier	1040162 2 1	PA311-13	13..16	CA212-49	40,42..53	
450	CRF-R	17->	520	114	alu	2080162 2 1	PA311-13	13..16	AB212-49	40,42..53	
450	CRF-R	17->	520	114	stealth ■	4R40162 2 1	PA311-13	13..16	CA212SR-49	40,42..53	
450	CRF-R	17->	520	114	stealth ■	4N40162 2 1	PA311-13	13..16	CA212SN-49	40,42..53	
450	CRF-X	04-18	520	120	acier	1040170 5 1	PA311-13	13..16	CA212-51	40,42..53	
450	CRF-X	04-18	520	120	alu	2080170 5 1	PA311-13	13..16	AB212-51	40,42..53	
450	CRF-RX	18->	520	114	acier	1040130 5 1	PA311-13	13..16	CA212-50	40,42..53	
450	CRF-RX	18->	520	114	alu	2080130 5 1	PA311-13	13..16	AB212-50	40,42..53	
450	CRF-RX	18->	520	114	stealth ■	4R40130 5 1	PA311-13	13..16	CA212SR-50	40,42..53	
450	CRF-RX	18->	520	114	stealth ■	4N40130 5 1	PA311-13	13..16	CA212SN-50	40,42..53	
450	TRX R	04-05	520	94	acier	1040160 5 1	PA311-14	13..16	CA318-38	36,38..40	
450	TRX R	06-14	520	96	acier	1040161 5 1	PA311-13	13..16	CA318-38	36,38..40	
500	CR	88-91	520	116	alu	2080120 2 1	PA311-14	13..16	AB212-49	40,42..53	
500	CR	92->	520	114	alu	2080121 2 1	PA311-14	13..16	AB212-49	40,42..53	
600	XR R	<-87	520	110	acier	1040430 5 1	PA500-14	13..16	CA304-48	38..53	
600	XR R	88-90	520	112	acier	1040361 5 1	PA500-14	13..16	CA501-50	42..43,45..48,50	
600	XR R	91-00	520	110	acier	1040364 5 1	PA510-14	13..16	CA320-48	39,40,45,48	
650	XRR	00-07	520	110	acier	1040365 5 1	PA517-14	13..15	CA212-48	40,42..53	
650	XRR	00-07	520	110	alu	2080365 5 1	PA517-14	13..15	AB212-48	40,42..53	

TRANSMISSION

Cyl	Modèle	Année	CHAÎNE		KIT			PIGNON		COURONNE	
			Pas	Maillons	Matériau	RÉFÉRENCE Racine Qualité Attache	Référence	Nb dents dispos	Référence	Nb dents dispos	
HRD											
50	Enduro / SM	03-11	420	134	acier	1014100 2 1	PT119-12	11..15	CO104-56	50,56	
HUSABERG											
125	TE 2T	14->	520	116	acier	1071702 5 1	PR301-13	11..16	CO304-50	38,40..53	
125	TE 2T	14->	520	116	alu	2072702 5 1	PR301-13	11..16	AP304-50	36..40,42..54	
125	TE 2T	14->	520	116	stealth ■	4G71702 5 1	PR301-13	11..16	CO304SG-50	38,40..53	
250	FE	14->	520	116	acier	1071702 5 1	PR301-13	11..16	CO304-50	38,40..53	
250	FE	14->	520	116	alu	2072702 5 1	PR301-13	11..16	AP304-50	36..40,42..54	
250	FE	14->	520	116	stealth ■	4G71702 5 1	PR301-13	11..16	CO304SG-50	38,40..53	
250	TE 2T	11-12	520	116	acier	1071702 5 1	PR301-13	11..16	CO304-50	38,40..53	
250	TE 2T	11-12	520	116	alu	2072702 5 1	PR301-13	11..16	AP304-50	36..40,42..54	
250	TE 2T	14->	520	118	acier	1071701 5 1	PR301-14	11..16	CO304-50	38,40..53	
250	TE 2T	14->	520	118	alu	2072701 5 1	PR301-14	11..16	AP304-50	36..40,42..54	
300	TE 2T	14->	520	118	acier	1071701 5 1	PR301-14	11..16	CO304-50	38,40..53	
300	TE 2T	14->	520	118	alu	2072701 5 1	PR301-14	11..16	AP304-50	36..40,42..54	
350	FE / TE	96-99	520	120	alu	2064200 5 1	PQ302-15	12..17	AU501-48	47,48,50	
350	FE	13->	520	118	acier	1071719 5 1	PR301-14	11..16	CO304-52	38,40..53	
350	FE	13->	520	118	alu	2072719 5 1	PR301-14	11..16	AP304-52	36..40,42..54	
350	FE	13->	520	118	stealth ■	4G71719 5 1	PR301-14	11..16	CO304SG-52	38,40..53	
390	FE	10->	520	116	acier	1071707 5 1	PR301-13	11..16	CO304-52	38,40..53	
390	FE	10->	520	116	alu	2072707 5 1	PR301-13	11..16	AP304-52	36..40,42..54	
400	FE	99-99	520	120	alu	2064200 5 1	PQ302-15	12..17	AU501-48	47,48,50	
400	FE	00-02	520	114	acier	1064201 5 1	PQ302-13	12..17	CO304-48	38,40..53	
400	FE	00-02	520	114	alu	2064201 5 1	PQ302-13	12..17	AP304-48	36..40,42..54	
450	FC	04-07	520	116	acier	1064250 5 1	PQ302-13	12..17	CO304-48	38,40..53	
450	FC	04-07	520	116	alu	2064250 5 1	PQ302-13	12..17	AP304-48	36..40,42..54	
450	FE / E	03-08	520	116	acier	1064260 5 1	PQ302-15	12..17	CO304-48	38,40..53	
450	FE / E	03-08	520	116	alu	2064260 5 1	PQ302-15	12..17	AP304-48	36..40,42..54	
450	FE	08-13	520	116	acier	1071707 5 1	PR301-13	11..16	CO304-52	38,40..53	
450	FE	08-13	520	116	alu	2072707 5 1	PR301-13	11..16	AP304-52	36..40,42..54	
501	FE / E	03-04	520	116	acier	1064312 5 1	PQ302-15	12..17	CO304-48	38,40..53	
501	FE / E	03-04	520	116	alu	2064312 5 1	PQ302-15	12..17	AP304-48	36..40,42..54	
501	FE	13->	520	118	acier	1071701 5 1	PR301-14	11..16	CO304-50	38,40..53	
501	FE	13->	520	118	alu	2072701 5 1	PR301-14	11..16	AP304-50	36..40,42..54	
501	TE	<-99	520	120	alu	2064300 5 1	PQ302-14	12..17	AU501-48	47,48,50	
501	TE	00->	520	120	alu	2064301 5 1	PQ302-14	12..17	AP304-47	36..40,42..54	
550	FE	04-07	520	116	acier	1064260 5 1	PQ302-15	12..17	CO304-48	38,40..53	
550	FE	04-07	520	116	alu	2064260 5 1	PQ302-15	12..17	AP304-48	36..40,42..54	
570	FE	10->	520	116	acier	1071707 5 1	PR301-13	11..16	CO304-52	38,40..53	
570	FE	10->	520	116	alu	2072707 5 1	PR301-13	11..16	AP304-52	36..40,42..54	
570	FS	10->	520	110	acier	1064261 5 1	PR301-14	11..16	CO304-38	38,40..53	
600	FC Moto Cross	98-99	520	120	alu	2064401 5 1	PQ302-14	12..17	AU501-48	47,48,50	
600	FC Moto Cross	00->	520	120	acier	1064404 5 1	PQ302-14	12..17	CO304-48	38,40..53	
600	FC Moto Cross	00->	520	120	alu	2064404 5 1	PQ302-14	12..17	AP304-48	36..40,42..54	
600	FE	00-03	520	114	acier	1064405 5 1	PQ302-15	12..17	CO304-48	38,40..53	
600	FE	00-03	520	114	alu	2064405 5 1	PQ302-15	12..17	AP304-48	36..40,42..54	
HUSQVARNA											
50	TC	17-22	415	104	alu	2072004 2 1	PT122-11	9..11	AP103-40	40..42	
50	TC Mini	17-22	415	96	alu	2072006 2 1	PT122-10	9..11	AP103-42	40..42	
65	TC	17->	420	112	acier	1071005 2 1	PT120-14	12..14	CO101-48	46,48,50	
65	TC	17->	420	112	alu	2072005 2 1	PT120-14	12..14	AP101-48	46,48,50	
65	TC	17->	420	112	stealth ■	4G71005 2 1	PT120-14	12..14	CO101SG-48	46,48,50	
85	TC 19/16 G.R.	14-17	428	124	acier	1071050 2 1	PT202-14	12..14	CO200-49	46,49,51	
85	TC 19/16 G.R.	14-17	428	124	alu	2072050 2 1	PT202-14	12..14	AP102-49	46..51	
85	TC 19/16 G.R.	14-17	428	124	stealth ■	4G71050 2 1	PT202-14	12..14	CO200SG-49	46,49,51	
85	TC 17/14 P.R.	18->	428	122	acier	1071054 2 1	PT202-13	12..14	CO200-46	46,49,51	
85	TC 17/14 P.R.	18->	428	122	alu	2072054 2 1	PT202-13	12..14	AP102-46	46..51	
85	TC 17/14 P.R.	18->	428	122	stealth ■	4G71054 2 1	PT202-13	12..14	CO200SG-46	46,49,51	
85	TC 19/16 G.R.	18->	428	124	acier	1071055 2 1	PT202-13	12..14	CO200-49	46,49,51	
85	TC 19/16 G.R.	18->	428	124	alu	2072055 2 1	PT202-13	12..14	AP102-49	46..51	



Cyl	Modèle	Année	CHAÎNE		KIT			PIGNON		COURONNE	
			Pas	Maillons	Matériau	RÉFÉRENCE Racine Qualité Attache	Référence	Nb dents dispos	Référence	Nb dents dispos	
85	TC 19/16 G.R.	18->	428	124	stealth ■	4G71055 2 1	PT202-13	12..14	CO2005G-49	46,49,51	
125	CR	95-97	520	114	alu	2063010 2 1	PQ200-12	12..14	AF206-50	39,41..53	
125	CR	98-08	520	114	acier	1063011 2 1	PQ201-13	13	CE206-50	40..53	
125	CR	98-08	520	114	alu	2063011 2 1	PQ201-13	13	AF206-50	39,41..53	
125	CR	09-12	520	112	acier	1063014 2 1	PQ201-13	13	CE206-50	40..53	
125	CR	09-12	520	112	alu	2063014 2 1	PQ201-13	13	AF206-50	39,41..53	
125	TC 2T	14-19	520	116	acier	1071702 2 1	PR301-13	11..16	CO304-50	38,40..53	
125	TC 2T	14-19	520	116	alu	2072702 2 1	PR301-13	11..16	AP304-50	36..40,42..54	
125	TC 2T	14-19	520	116	stealth ■	4B71702 2 1	PR301-13	11..16	CO304SB-50	38,40..53	
125	TC 2T	14-19	520	116	stealth ■	4G71702 2 1	PR301-13	11..16	CO304SG-50	38,40..53	
125	TC 2T	20->	520	118	acier	1071302 2 1	PR301-13	11..16	CO304-51	38,40..53	
125	TC 2T	20->	520	118	alu	2072302 2 1	PR301-13	11..16	AP304-51	36..40,42..54	
125	TC 2T	20->	520	118	stealth ■	4B71302 2 1	PR301-13	11..16	CO304SB-51	38,40..53	
125	TC 2T	20->	520	118	stealth ■	4G71302 2 1	PR301-13	11..16	CO304SG-51	38,40..53	
125	TE 2T	14->	520	116	acier	1071702 5 1	PR301-13	11..16	CO304-50	38,40..53	
125	TE 2T	14->	520	116	alu	2072702 5 1	PR301-13	11..16	AP304-50	36..40,42..54	
125	TE 2T	14->	520	116	stealth ■	4B71702 5 1	PR301-13	11..16	CO304SB-50	38,40..53	
125	TE 2T	14->	520	116	stealth ■	4G71702 5 1	PR301-13	11..16	CO304SG-50	38,40..53	
125	TX 2T	17-19	520	116	acier	1071702 5 1	PR301-13	11..16	CO304-50	38,40..53	
125	TX 2T	17-19	520	116	alu	2072702 5 1	PR301-13	11..16	AP304-50	36..40,42..54	
125	TX 2T	17-19	520	116	stealth ■	4B71702 5 1	PR301-13	11..16	CO304SB-50	38,40..53	
125	TX 2T	17-19	520	116	stealth ■	4G71702 5 1	PR301-13	11..16	CO304SG-50	38,40..53	
125	WR	95-97	520	114	alu	2063013 5 1	PQ200-13	12..14	AF206-52	39,41..53	
125	WR	98-14	520	114	acier	1063011 5 1	PQ201-13	13	CE206-50	40..53	
125	WR	98-14	520	114	alu	2063011 5 1	PQ201-13	13	AF206-50	39,41..53	
125	WRE	94-94	520	114	alu	2063015 5 1	PQ200-13	12..14	AF206-52	39,41..53	
125	WRE	95-98	520	114	alu	2063016 5 1	PQ200-13	12..14	AF206-50	39,41..53	
125	WRE	99-08	520	116	alu	2063018 5 1	PQ200-13	12..14	AF206-52	39,41..53	
150	TE inj	20->	520	116	acier	1071702 5 1	PR301-13	11..16	CO304-50	38,40..53	
150	TE inj	20->	520	116	alu	2072702 5 1	PR301-13	11..16	AP304-50	36..40,42..54	
150	TE inj	20->	520	116	stealth ■	4B71702 5 1	PR301-13	11..16	CO304SB-50	38,40..53	
150	TE inj	20->	520	116	stealth ■	4G71702 5 1	PR301-13	11..16	CO304SG-50	38,40..53	
250	TC / TE	02-03	520	116	acier	1063042 5 1	PQ500-14	12..17	CE206-50	40..53	
250	TC / TE	02-03	520	116	alu	2063042 5 1	PQ500-14	12..17	AF206-50	39,41..53	
250	FC	14-17	520	116	acier	1071702 2 1	PR301-13	11..16	CO304-50	38,40..53	
250	FC	14-17	520	116	alu	2072702 2 1	PR301-13	11..16	AP304-50	36..40,42..54	
250	FC	14-17	520	116	stealth ■	4B71702 2 1	PR301-13	11..16	CO304SB-50	38,40..53	
250	FC	14-17	520	116	stealth ■	4G71702 2 1	PR301-13	11..16	CO304SG-50	38,40..53	
250	FC	18-22	520	118	acier	1071301 2 1	PR301-14	11..16	CO304-51	38,40..53	
250	FC	18-22	520	118	alu	2072301 2 1	PR301-14	11..16	AP304-51	36..40,42..54	
250	FC	18-22	520	118	stealth ■	4B71301 2 1	PR301-14	11..16	CO304SB-51	38,40..53	
250	FC	18-22	520	118	stealth ■	4G71301 2 1	PR301-14	11..16	CO304SG-51	38,40..53	
250	FE	14->	520	118	acier	1071707 5 1	PR301-13	11..16	CO304-52	38,40..53	
250	FE	14->	520	118	alu	2072707 5 1	PR301-13	11..16	AP304-52	36..40,42..54	
250	FE	14->	520	118	stealth ■	4B71707 5 1	PR301-13	11..16	CO304SB-52	38,40..53	
250	FE	14->	520	118	stealth ■	4G71707 5 1	PR301-13	11..16	CO304SG-52	38,40..53	
250	TC	04-05	520	116	acier	1063044 2 1	PQ500-13	12..17	CE206-50	40..53	
250	TC	04-05	520	116	alu	2063044 2 1	PQ500-13	12..17	AF206-50	39,41..53	
250	TC	06-09	520	116	acier	1063045 2 1	PQ500-12	12..17	CE206-50	40..53	
250	TC	06-09	520	116	alu	2063045 2 1	PQ500-12	12..17	AF206-50	39,41..53	
250	TC	09-13	520	116	acier	1063049 2 1	PQ502-13	13	CE206-50	40..53	
250	TC	09-13	520	116	alu	2063049 2 1	PQ502-13	13	AF206-50	39,41..53	
250	TC	14-15	520	116	acier	1071702 2 1	PR301-13	11..16	CO304-50	38,40..53	
250	TC	14-15	520	116	alu	2072702 2 1	PR301-13	11..16	AP304-50	36..40,42..54	
250	TC	14-15	520	116	stealth ■	4B71702 2 1	PR301-13	11..16	CO304SB-50	38,40..53	
250	TC	14-15	520	116	stealth ■	4G71702 2 1	PR301-13	11..16	CO304SG-50	38,40..53	
250	TC	16-17	520	114	alu	1071300 2 1	PR301-13	11..16	CO304-48	38,40..53	
250	TC	16-17	520	114	alu	2072300 2 1	PR301-13	11..16	AP304-48	36..40,42..54	
250	TC	16-17	520	114	stealth ■	4B71300 2 1	PR301-13	11..16	CO304SB-48	38,40..53	
250	TC	16-17	520	114	stealth ■	4G71300 2 1	PR301-13	11..16	CO304SG-48	38,40..53	

TRANSMISSION

Cyl	Modèle	Année	CHAÎNE		KIT			PIGNON		COURONNE	
			Pas	Maillons	Matériau	RÉFÉRENCE Racine Qualité Attache	Référence	Nb dents dispos	Référence	Nb dents dispos	
HUSQVARNA											
250	TC	18-20	520	118	acier	10717012 1	PR301-14	11..16	CO304-50	38,40..53	
250	TC	18-20	520	118	alu	20727012 1	PR301-14	11..16	AP304-50	36..40,42..54	
250	TC	18-20	520	118	stealth■	4B717012 1	PR301-14	11..16	CO304SB-50	38,40..53	
250	TC	18-20	520	118	stealth■	4G717012 1	PR301-14	11..16	CO304SG-50	38,40..53	
250	TC	21->	520	116	acier	10717122 1	PR301-14	11..16	CO304-49	38,40..53	
250	TC	21->	520	116	alu	20727122 1	PR301-14	11..16	AP304-49	36..40,42..54	
250	TC	21->	520	116	stealth■	4B717122 1	PR301-14	11..16	CO304SB-49	38,40..53	
250	TC	21->	520	116	stealth■	4G717122 1	PR301-14	11..16	CO304SG-49	38,40..53	
250	TE	04-09	520	116	acier	10630445 1	PQ500-13	12..17	CE206-50	40..53	
250	TE	04-09	520	116	alu	20630445 1	PQ500-13	12..17	AF206-50	39,41..53	
250	TE	10-13	520	116	acier	10630495 1	PQ502-13	13	CE206-50	40..53	
250	TE	10-13	520	116	alu	20630495 1	PQ502-13	13	AF206-50	39,41..53	
250	TE 2T / TE i	14-21	520	118	acier	10717025 1	PR301-13	11..16	CO304-50	38,40..53	
250	TE 2T / TE i	14-21	520	118	alu	20727025 1	PR301-13	11..16	AP304-50	36..40,42..54	
250	TE 2T / TE i	14-21	520	118	stealth■	4B717025 1	PR301-13	11..16	CO304SB-50	38,40..53	
250	TE 2T / TE i	14-21	520	118	stealth■	4G717025 1	PR301-13	11..16	CO304SG-50	38,40..53	
250	TE i	22->	520	118	acier	10717075 1	PR301-13	11..16	CO304-52	38,40..53	
250	TE i	22->	520	118	alu	20727075 1	PR301-13	11..16	AP304-52	36..40,42..54	
250	TE i	22->	520	118	stealth■	4B717075 1	PR301-13	11..16	CO304SB-52	38,40..53	
250	TE i	22->	520	118	stealth■	4G717075 1	PR301-13	11..16	CO304SG-52	38,40..53	
250	WR/CR	92-98	520	114	acier	10630305 1	PE302-14	13..15	CE206-48	40..53	
250	WR/CR	92-98	520	114	alu	20630305 1	PE302-14	13..15	AF206-48	39,41..53	
250	WR/CR	99-11	520	114	acier	10630315 1	PQ500-13	12..17	CE206-48	40..53	
250	WR/CR	99-11	520	114	alu	20630315 1	PQ500-13	12..17	AF206-48	39,41..53	
300	TE 2T / TE i	14->	520	118	acier	10717025 1	PR301-13	11..16	CO304-50	38,40..53	
300	TE 2T / TE i	14->	520	118	alu	20727025 1	PR301-13	11..16	AP304-50	36..40,42..54	
300	TE 2T / TE i	14->	520	118	stealth■	4B717025 1	PR301-13	11..16	CO304SB-50	38,40..53	
300	TE 2T / TE i	14->	520	118	stealth■	4G717025 1	PR301-13	11..16	CO304SG-50	38,40..53	
300	WR	09-10	520	114	acier	10630315 1	PQ500-13	12..17	CE206-48	40..53	
300	WR	09-10	520	114	alu	20630315 1	PQ500-13	12..17	AF206-48	39,41..53	
310	TE	09-10	520	116	acier	10630445 1	PQ500-13	12..17	CE206-50	40..53	
310	TE	09-10	520	116	alu	20630445 1	PQ500-13	12..17	AF206-50	39,41..53	
350	FC	14-19	520	118	acier	10717012 1	PR301-14	11..16	CO304-50	38,40..53	
350	FC	14-19	520	118	alu	20727012 1	PR301-14	11..16	AP304-50	36..40,42..54	
350	FC	14-19	520	118	stealth■	4B717012 1	PR301-14	11..16	CO304SB-50	38,40..53	
350	FC	14-19	520	118	stealth■	4G717012 1	PR301-14	11..16	CO304SG-50	38,40..53	
350	FC	20->	520	118	acier	10713012 1	PR301-14	11..16	CO304-51	38,40..53	
350	FC	20->	520	118	alu	20723012 1	PR301-14	11..16	AP304-51	36..40,42..54	
350	FC	20->	520	118	stealth■	4B713012 1	PR301-14	11..16	CO304SB-51	38,40..53	
350	FC	20->	520	118	stealth■	4G713012 1	PR301-14	11..16	CO304SG-51	38,40..53	
350	FE	13->	520	116	acier	10717075 1	PR301-13	11..16	CO304-52	38,40..53	
350	FE	13->	520	116	alu	20727075 1	PR301-13	11..16	AP304-52	36..40,42..54	
350	FE	13->	520	116	stealth■	4B717075 1	PR301-13	11..16	CO304SB-52	38,40..53	
350	FE	13->	520	116	stealth■	4G717075 1	PR301-13	11..16	CO304SG-52	38,40..53	
350	TE	91-92	520	116	acier	10630425 1	PQ500-14	12..17	CE206-50	40..53	
350	TE	91-92	520	116	alu	20630425 1	PQ500-14	12..17	AF206-50	39,41..53	
360	WR	92-99	520	114	acier	10631305 1	PE302-15	13..15	CE206-48	40..53	
360	WR	92-99	520	114	alu	20631305 1	PE302-15	13..15	AF206-48	39,41..53	
360	WR	00-00	520	114	acier	10631105 1	PQ500-15	12..17	CE206-48	40..53	
360	WR	00-00	520	114	alu	20631105 1	PQ500-15	12..17	AF206-48	39,41..53	
400	WR	85-85	520	120	alu	20630005 1	PQ302-14	12..17	AN300-52	48,52	
410	TE	98-01	520	116	acier	10630435 1	PQ500-13	12..17	CE206-48	40..53	
410	TE	98-01	520	116	alu	20630435 1	PQ500-13	12..17	AF206-48	39,41..53	
410	TE	02-	520	116	acier	10630425 1	PQ500-14	12..17	CE206-50	40..53	
410	TE	02-	520	116	alu	20630425 1	PQ500-14	12..17	AF206-50	39,41..53	
449	TC	11-13	520	110	acier	10630475 1	PP303-15	15	CE206-53	40..53	
449	TC	11-13	520	110	alu	20630475 1	PP303-15	15	AF206-53	39,41..53	
449	TE	11-13	520	108	acier	10630485 1	PP303-15	15	CE206-51	40..53	
449	TE	11-13	520	108	alu	20630485 1	PP303-15	15	AF206-51	39,41..53	



Cyl	Modèle	Année	CHAÎNE		KIT			PIGNON		COURONNE	
			Pas	Maillons	Matériau	RÉFÉRENCE Racine Qualité Attache	Référence	Nb dents dispos	Référence	Nb dents dispos	
450	FC	14-15	520	118	acier	10717012 1	PR301-14	11..16	CO304-50	38,40..53	
450	FC	14-15	520	118	alu	20727012 1	PR301-14	11..16	AP304-50	36..40,42..54	
450	FC	16-19	520	114	alu	10713002 1	PR301-13	11..16	CO304-48	38,40..53	
450	FC	16-19	520	114	alu	20723002 1	PR301-13	11..16	AP304-48	36..40,42..54	
450	FC	16-19	520	114	stealth ■	4B713002 1	PR301-13	11..16	CO304SB-48	38,40..53	
450	FC	16-19	520	114	stealth ■	4G713002 1	PR301-13	11..16	CO304SG-48	38,40..53	
450	FC	20->	520	116	alu	10713032 1	PR301-13	11..16	CO304-49	38,40..53	
450	FC	20->	520	116	alu	20723032 1	PR301-13	11..16	AP304-49	36..40,42..54	
450	FC	20->	520	116	stealth ■	4B713032 1	PR301-13	11..16	CO304SB-49	38,40..53	
450	FC	20->	520	116	stealth ■	4G713032 1	PR301-13	11..16	CO304SG-49	38,40..53	
450	FE	13->	520	118	acier	10717075 1	PR301-13	11..16	CO304-52	38,40..53	
450	FE	13->	520	118	alu	20727075 1	PR301-13	11..16	AP304-52	36..40,42..54	
450	FE	13->	520	118	stealth ■	4B717075 1	PR301-13	11..16	CO304SB-52	38,40..53	
450	FE	13->	520	118	stealth ■	4G717075 1	PR301-13	11..16	CO304SG-52	38,40..53	
450	TE	02-10	520	116	acier	10630605 1	PQ500-15	12..17	CE206-50	40..53	
450	TE	02-10	520	116	alu	20630605 1	PQ500-15	12..17	AF206-50	39,41..53	
450	TC	02-10	520	116	acier	10630422 1	PQ500-14	12..17	CE206-50	40..53	
450	TC	02-10	520	116	alu	20630422 1	PQ500-14	12..17	AF206-50	39,41..53	
500	CR	85-85	520	120	alu	20630402 1	PQ302-14	12..17	AN300-52	48,52	
501	FE	13->	520	118	acier	10717015 1	PR301-14	11..16	CO304-50	38,40..53	
501	FE	13->	520	118	alu	20727015 1	PR301-14	11..16	AP304-50	36..40,42..54	
501	FE	13->	520	118	stealth ■	4B717012 1	PR301-14	11..16	CO304SB-50	38,40..53	
501	FE	13->	520	118	stealth ■	4G717012 1	PR301-14	11..16	CO304SG-50	38,40..53	
510	TC	09->	520	116	acier	10630615 1	PQ500-14	12..17	CE206-47	40..53	
510	TC	09->	520	116	alu	20630615 1	PQ500-14	12..17	AF206-47	39,41..53	
510	TE	87-89	520	116	alu	20630995 1	PQ500-14	12..17	AN300-48	48,52	
510	TE	90-91	520	116	acier	10631005 1	PQ500-14	12..17	CE206-48	40..53	
510	TE	90-91	520	116	alu	20631005 1	PQ500-14	12..17	AF206-48	39,41..53	
510	TE	07->	520	116	acier	10630465 1	PQ500-13	12..17	CE206-47	40..53	
510	TE	07->	520	116	alu	20630465 1	PQ500-13	12..17	AF206-47	39,41..53	
570	TE	02-	520	114	acier	10631105 1	PQ500-15	12..17	CE206-48	40..53	
570	TE	02-	520	114	alu	20631105 1	PQ500-15	12..17	AF206-48	39,41..53	
610	SM	98-00	520	120	alu	20631205 1	PQ500-15	12..17	AF206-45	39,41..53	
610	TE	91-01	520	116	acier	10631015 1	PQ500-14	12..17	CE206-48	40..53	
610	TE	91-01	520	116	alu	20631015 1	PQ500-14	12..17	AF206-48	39,41..53	
610	TE E	99-02	520	114	acier	10630505 1	PQ500-15	12..17	CE206-45	40..53	
610	TE E	99-02	520	114	alu	20630505 1	PQ500-15	12..17	AF206-45	39,41..53	
690	Enduro 701	17-19	520	118		10717095 1	PR303-15	13..17	CO304-45	38,40..53	
KAWASAKI											
50	KFX	03-04	420	78	acier	10700322 1	PH100-10	10..15	CE112-37	37	
60	KX	83-01	420	104	acier	10600102 1	PK100-13	12..16	CG100-44	44,48..50	
60	KX	83-01	420	104	alu	20820102 1	PK100-13	12..16	AH100-44	44	
65	KX	00-01	420	112	alu	20820112 1	PK100-13	12..16	AH107-46	46,47	
65	KX	02-20	420	112	acier	10600122 1	PK100-13	12..16	CG107-47	47	
65	KX	02-20	420	112	alu	20820122 1	PK100-13	12..16	AH107-47	46,47	
80	KSF80 A1-A3 (KFX80)	03-05	520	36	acier	10600351 1	PC104-10	10	CE110-22	22	
80	KX P.R. (#428)	90-97	428	118	alu	20820512 1	PE100-13	13,14	AH105-49	49,51..54	
80	KX P.R. (#420)	98->	420	120	alu	20820542 1	PK100-14	12..16	AH104-51	49..54	
80	KX P.R. (#428)	98->	428	120	alu	20820552 1	PE100-14	13,14	AH105-51	49,51..54	
80	KX G.R. (#420)	92-97	420	124	alu	20820522 1	PK100-13	12..16	AH104-54	49..54	
80	KX G.R. (#428)	92-97	428	124	alu	20820532 1	PE100-13	13,14	AH105-54	49,51..54	
80	KX G.R. (#420)	98->	420	124	alu	20820562 1	PK100-13	12..16	AH104-51	49..54	
80	KX G.R. (#428)	98->	428	130	alu	20820572 1	PE100-13	13,14	AH105-51	49,51..54	
85	KX P.R. (#420)	01-20	420	120	acier	10600582 1	PK100-14	12..16	CG104-50	47..54	
85	KX P.R. (#420)	01-20	420	120	alu	20820582 1	PK100-14	12..16	AH104-50	49..54	
85	KX P.R. (#428)	01-20	428	120	acier	10600592 1	PE100-14	13,14	CG105-51	49...52,54	
85	KX P.R. (#428)	01-20	428	120	alu	20820592 1	PE100-14	13,14	AH105-51	49,51..54	
85	KX G.R. (#420)	01-20	420	130	acier	10600612 1	PK100-13	12..16	CG104-51	47..54	
85	KX G.R. (#420)	01-20	420	130	alu	20820612 1	PK100-13	12..16	AH104-51	49..54	
85	KX G.R. (#428)	01-20	428	130	acier	10600572 1	PE100-13	13,14	CG105-51	49...52,54	

TRANSMISSION

Cyl	Modèle	Année	CHAÎNE		KIT			PIGNON		COURONNE	
			Pas	Maillons	Matériau	RÉFÉRENCE Racine Qualité Attache	Référence	Nb dents dispos	Référence	Nb dents dispos	
KAWASAKI											
85	KX G.R. (#428)	01-20	428	130	alu	2082057 2 1	PE100-13	13,14	AH105-51	49,51..54	
125	KX	86-89	520	112	alu	2082100 2 1	PK200-12	12,13	AH206-47	45..52	
125	KX	90-91	520	112	alu	2082101 2 1	PK200-12	12,13	AH206-48	45..52	
125	KX	92-93	520	112	alu	2082103 2 1	PK200-12	12,13	AH206-49	45..52	
125	KX	94-95	520	110	alu	2082104 2 1	PE201-12	11..13	AH206-49	45..52	
125	KX	96-97	520	112	alu	2082105 2 1	PE201-13	11..13	AH206-50	45..52	
125	KX	98-99	520	112	alu	2082106 2 1	PE201-12	11..13	AH206-48	45..52	
125	KX	00-02	520	110	alu	2082107 2 1	PE201-12	11..13	AH206-49	45..52	
125	KX	03-03	520	112	alu	2082108 2 1	PE201-13	11..13	AH206-51	45..52	
125	KX	04-09	520	114	acier	1060109 2 1	PE201-13	11..13	CG204-51	42,44,47..53	
125	KX	04-09	520	114	alu	2082109 2 1	PE201-13	11..13	AH206-51	45..52	
250	KSF A1-A18 Mojave	87-04	520	90	acier	1060202 5 1	PE303-12	12	CG310-43	41,43	
250	KX	87-89	520	114	alu	2082102 2 1	PK300-14	10..17	AH206-47	45..52	
250	KX	90-91	520	114	alu	2082131 2 1	PK300-14	10..17	AH206-48	45..52	
250	KX	92-93	520	114	alu	2082132 2 1	PK300-14	10..17	AH206-49	45..52	
250	KX	94-98	520	114	alu	2082133 2 1	PK300-14	10..17	AH206-49	45..52	
250	KX	99-02	520	114	acier	1060134 2 1	PH500-14	13..17	CG204-49	42,44,47..53	
250	KX	99-02	520	114	alu	2082134 2 1	PH500-14	13..17	AH206-49	45..52	
250	KX	03-04	520	114	acier	1060135 2 1	PH500-13	13..17	CG204-49	42,44,47..53	
250	KX	03-04	520	114	alu	2082135 2 1	PH500-13	13..17	AH206-49	45..52	
250	KX	05-06	520	116	alu	2082136 2 1	PH500-14	13..17	AH206-51	45..52	
250	KX	07-08	520	116	acier	1060137 2 1	PH500-13	13..17	CG204-51	42,44,47..53	
250	KX	07-08	520	116	alu	2082137 2 1	PH500-13	13..17	AH206-51	45..52	
250	KX-F N1-N2	04-05	520	114	acier	1060160 2 1	PC301-13	13..15	CG204-48	42,44,47..53	
250	KX-F N1-N2	04-05	520	114	alu	2082160 2 1	PC301-13	13..15	AH206-48	45..52	
250	KX-F T6F	06-10	520	112	acier	1060162 2 1	PE311-13	13,14	CG204-48	42,44,47..53	
250	KX-F T6F	06-10	520	112	alu	2082162 2 1	PE311-13	13,14	AH206-48	45..52	
250	KX-F T6F	06-10	520	112	stealth■	4G60162 2 1	PE311-13	13,14	CG204SG-48	42,44,47..53	
250	KX-F / KX	11->	520	114	acier	1060166 2 1	PE311-13	13,14	CG204-50	42,44,47..53	
250	KX-F / KX	11->	520	114	alu	2082166 2 1	PE311-13	13,14	AH206-50	45..52	
250	KX-F / KX	11->	520	114	stealth■	4G60166 2 1	PE311-13	13,14	CG204SG-50	42,44,47..53	
250	KX-F / KX	11->	520	114	stealth■	4N60166 2 1	PE311-13	13,14	CG204SN-50	42,44,47..53	
250	KX-X Enduro (KL)	22->	520	114	acier	1060167 2 1	PE311-13	13,14	CG204-51	42,44,47..53	
250	KX-X Enduro (KL)	22->	520	114	alu	2082167 2 1	PE311-13	13,14	AH206-51	45..52	
250	KX-X Enduro (KL)	22->	520	114	stealth■	4G60167 2 1	PE311-13	13,14	CG204SG-51	42,44,47..53	
250	KX-X Enduro (KL)	22->	520	114	stealth■	4N60167 2 1	PE311-13	13,14	CG204SN-51	42,44,47..53	
300	KEF A1-A6, B1-B3 Lakota / KFX 04	95-04	520	100	acier	1060210 5 1	PE303-12	12	CG310-43	41,43	
300	KLXR	98-01	520	110	acier	1060180 5 1	PK300-14	10..17	CG204-50	42,44,47..53	
300	KLXR	02-07	520	110	acier	1060181 5 1	PH500-14	13..17	CG204-50	42,44,47..53	
400	KSF A1-A3 (KFX)	02-08	520	112	acier	1070245 5 1	PE310-14	13..16	CE310-40	39..44	
450	KFX-R Quad	08->	520	94	acier	1060282 5 1	PE313-14	14..16	CG406-38	37...39	
450	KLX-R	07-17	520	116	acier	1060281 5 1	PE312-13	12..14	CG204-50	42,44,47..53	
450	KLX-R	07-17	520	116	alu	2082281 5 1	PE312-13	12..14	AH206-50	45..52	
450	KX-F / KX	06->	520	114	acier	1060280 2 1	PE312-13	12..14	CG204-50	42,44,47..53	
450	KX-F / KX	06->	520	114	alu	2082280 2 1	PE312-13	12..14	AH206-50	45..52	
450	KX-F / KX	06->	520	114	stealth■	4G60280 2 1	PE312-13	12..14	CG204SG-50	42,44,47..53	
450	KX-F / KX	06->	520	114	stealth■	4N60280 2 1	PE312-13	12..14	CG204SN-50	42,44,47..53	
450	KX-X Enduro (KL)	21->	520	114	acier	1060283 2 1	PE312-13	12..14	CG204-51	42,44,47..53	
450	KX-X Enduro (KL)	21->	520	114	alu	2082283 2 1	PE312-13	12..14	AH206-51	45..52	
450	KX-X Enduro (KL)	21->	520	114	stealth■	4G60283 2 1	PE312-13	12..14	CG204SG-51	42,44,47..53	
450	KX-X Enduro (KL)	21->	520	114	stealth■	4N60283 2 1	PE312-13	12..14	CG204SN-51	42,44,47..53	
500	KX	84-84	520	120	alu	2082146 2 1	PE302-14	13..15	AH206-46	45..52	
500	KX	85-85	520	112	alu	2082147 2 1	PE302-14	13..15	AH206-46	45..52	
500	KX	86-86	520	114	alu	2082148 2 1	PE302-14	13..15	AH206-48	45..52	
500	KX	87->	520	114	alu	2082149 2 1	PK300-14	10..17	AH206-47	45..52	



Cyl	Modèle	Année	CHAÎNE		KIT			PIGNON		COURONNE	
			Pas	Maillons	Matériau	RÉFÉRENCE Racine Qualité Attache	Référence	Nb dents dispos	Référence	Nb dents dispos	
KTM											
50	EXC	96->	428	96	alu	2072004 2 1	PT202-12	12..14			
50	SX /Adventure /Pro Junior	97-99	415	94	acier	1071000 2 1	PT122-11	9..11	CX107-44	44	
50	SX Pro Senior	97->	415	94	acier	1071000 2 1	PT122-11	9..11	CX107-44	44	
50	SX Pro Senior LC	02->	415	102	alu	2072001 2 1	PT122-11	9..11	AU108-44	44	
50	SX	14-20	415	104	alu	2072004 2 1	PT122-11	9..11	AP103-40	40..42	
50	SX Mini	14->	415	96	alu	2072006 2 1	PT122-10	9..11	AP103-42	40..42	
60	SX / 65 SX	99-01	420	108	alu	2072002 2 1	PT120-12	12..14	AP101-46	46,48,50	
60	SX / 65 SX	99-01	420	108	stealth ■	4G72002 2 1	PT120-12	12..14	CO101SG-46	46,48,50	
65	SX	02-10	420	112	acier	1071003 2 1	PT120-14	12..14	CO101-50	46,48,50	
65	SX	02-10	420	112	alu	2072003 2 1	PT120-14	12..14	AP101-50	46,48,50	
65	SX	11-20	420	112	acier	1071005 2 1	PT120-14	12..14	CO101-48	46,48,50	
65	SX	11-20	420	112	alu	2072005 2 1	PT120-14	12..14	AP101-48	46,48,50	
65	SX	11-20	420	112	stealth ■	4G71005 2 1	PT120-14	12..14	CO101SG-48	46,48,50	
85	SX P.R. 17/14	03-17	428	120	acier	1071051 2 1	PT202-14	12..14	CO200-46	46,49,51	
85	SX P.R. 17/14	03-17	428	120	alu	2072051 2 1	PT202-14	12..14	AP102-46	46..51	
85	SX P.R. 17/14	03-17	428	120	stealth ■	4G71051 2 1	PT202-14	12..14	CO200SG-46	46,49,51	
85	SX P.R. 17/14	18->	428	122	acier	1071054 2 1	PT202-13	12..14	CO200-46	46,49,51	
85	SX P.R. 17/14	18->	428	122	alu	2072054 2 1	PT202-13	12..14	AP102-46	46..51	
85	SX P.R. 17/14	18->	428	122	stealth ■	4G71054 2 1	PT202-13	12..14	CO200SG-46	46,49,51	
85	SX G.R. 19/16	03-17	428	124	acier	1071050 2 1	PT202-14	12..14	CO200-49	46,49,51	
85	SX G.R. 19/16	03-17	428	124	alu	2072050 2 1	PT202-14	12..14	AP102-49	46..51	
85	SX G.R. 19/16	03-17	428	124	stealth ■	4G71050 2 1	PT202-14	12..14	CO200SG-49	46,49,51	
85	SX G.R. 19/16	03-17	428	124	stealth ■	4N71050 2 1	PT202-14	12..14	CO200SN-49	46,49,51	
85	SX G.R. 19/16	18->	428	124	acier	1071055 2 1	PT202-13	12..14	CO200-49	46,49,51	
85	SX G.R. 19/16	18->	428	124	alu	2072055 2 1	PT202-13	12..14	AP102-49	46..51	
85	SX G.R. 19/16	18->	428	124	stealth ■	4G71055 2 1	PT202-13	12..14	CO200SG-49	46,49,51	
85	SX G.R. 19/16	18->	428	124	stealth ■	4N71055 2 1	PT202-13	12..14	CO200SN-49	46,49,51	
125	EGS	99->	520	118	alu	2072102 5 1	PR301-14	11..16	AP304-48	36..40,42..54	
125	EXC Enduro	95-97	520	118	acier	1071101 5 1	PR301-13	11..16	CO304-48	38,40..53	
125	EXC Enduro	95-97	520	118	alu	2072101 5 1	PR301-13	11..16	AP304-48	36..40,42..54	
125	EXC Enduro	98-06	520	116	acier	1071702 5 1	PR301-13	11..16	CO304-50	38,40..53	
125	EXC Enduro	98-06	520	116	alu	2072702 5 1	PR301-13	11..16	AP304-50	36..40,42..54	
125	EXC Enduro	07-09	520	116	acier	1071707 5 1	PR301-13	11..16	CO304-52	38,40..53	
125	EXC Enduro	07-09	520	116	alu	2072707 5 1	PR301-13	11..16	AP304-52	36..40,42..54	
125	EXC Enduro	10-18	520	116	acier	1071702 5 1	PR301-13	11..16	CO304-50	38,40..53	
125	EXC Enduro	10-18	520	116	alu	2072702 5 1	PR301-13	11..16	AP304-50	36..40,42..54	
125	EXC Enduro	10-18	520	116	stealth ■	4O71702 5 1	PR301-13	11..16	CO304SO-50	38,40..53	
125	EXC Enduro	10-18	520	116	stealth ■	4G71702 5 1	PR301-13	11..16	CO304SG-50	38,40..53	
125	EXE	00->	520	118	acier	1071718 5 1	PR301-14	11..16	CO304-40	38,40..53	
125	EXE	00->	520	118	alu	2072718 5 1	PR301-14	11..16	AP304-40	36..40,42..54	
125	GS	85-90	520	118	alu	2072716 1 1	PR301-13	11..16	AP303-48	45,48,50,52,54	
125	GS	91-93	520	116	alu	2072702 1 1	PR301-13	11..16	AP304-50	36..40,42..54	
125	GS	94-97	520	112	acier	1071103 2 1	PR301-13	11..16	CO304-50	38,40..53	
125	GS	94-97	520	112	alu	2072103 2 1	PR301-13	11..16	AP304-50	36..40,42..54	
125	MX	85-89	520	118	alu	2072705 1 1	PR301-13	11..16	AP303-52	45,48,50,52,54	
125	MX	90-94	520	118	alu	2072702 1 1	PR301-13	11..16	AP304-50	36..40,42..54	
125	SX	94-98	520	112	acier	1071103 2 1	PR301-13	11..16	CO304-50	38,40..53	
125	SX	94-98	520	112	alu	2072103 2 1	PR301-13	11..16	AP304-50	36..40,42..54	
125	SX	99-19	520	116	acier	1071702 2 1	PR301-13	11..16	CO304-50	38,40..53	
125	SX	99-19	520	116	alu	2072702 2 1	PR301-13	11..16	AP304-50	36..40,42..54	
125	SX	99-19	520	116	stealth ■	4O71702 2 1	PR301-13	11..16	CO304SO-50	38,40..53	
125	SX	99-19	520	116	stealth ■	4G71702 2 1	PR301-13	11..16	CO304SG-50	38,40..53	
125	SX	20->	520	118	acier	1071302 2 1	PR301-13	11..16	CO304-51	38,40..53	
125	SX	20->	520	118	alu	2072302 2 1	PR301-13	11..16	AP304-51	36..40,42..54	
125	SX	20->	520	118	stealth	4O71302 2 1	PR301-13	11..16	CO304SO-51	38,40..53	
125	SX	20->	520	118	stealth	4G71302 2 1	PR301-13	11..16	CO304SG-51	38,40..53	
144	SX	08-08	520	118	acier	1071701 2 1	PR301-14	11..16	CO304-50	38,40..53	
144	SX	08-08	520	118	alu	2072701 2 1	PR301-14	11..16	AP304-50	36..40,42..54	
150	EXC TPI	20->	520	116	acier	1071702 5 1	PR301-13	11..16	CO304-50	38,40..53	

TRANSMISSION

Cyl	Modèle	Année	CHAÎNE		KIT			PIGNON		COURONNE	
			Pas	Maillons	Matériau	RÉFÉRENCE Racine Qualité Attache	Référence	Nb dents dispos	Référence	Nb dents dispos	
KTM											
150	EXC TPI	20->	520	116	alu	20727025	1	PR301-13	11..16	AP304-50	36..40,42..54
150	EXC TPI	20->	520	116	stealth	40717025	1	PR301-13	11..16	CO304SO-50	38,40..53
150	EXC TPI	20->	520	116	stealth	4G717025	1	PR301-13	11..16	CO304SG-50	38,40..53
150	SX	09-13	520	118	acier	10717012	1	PR301-14	11..16	CO304-50	38,40..53
150	SX	09-13	520	118	alu	20727012	1	PR301-14	11..16	AP304-50	36..40,42..54
150	SX	14-20	520	114	alu	10713002	1	PR301-13	11..16	CO304-48	38,40..53
150	SX	14-20	520	114	alu	20723002	1	PR301-13	11..16	AP304-48	36..40,42..54
200	EXC / EGS	98-99	520	118	acier	10717015	1	PR301-14	11..16	CO304-50	38,40..53
200	EXC / EGS	98-99	520	118	alu	20727015	1	PR301-14	11..16	AP304-50	36..40,42..54
200	EXC	00-13	520	118	acier	10717205	1	PR301-14	11..16	CO304-48	38,40..53
200	EXC	00-13	520	118	alu	20727205	1	PR301-14	11..16	AP304-48	36..40,42..54
200	EXC	14->	520	112	acier	10727245	1	PR301-14	11..16	CO304-45	38,40..53
200	EXC	14->	520	112	alu	20727245	1	PR301-14	11..16	AP304-45	36..40,42..54
200	SX	02-02	520	116	alu	20727072	1	PR301-13	11..16	AP304-52	36..40,42..54
200	SX	03-06	520	112	acier	10727242	1	PR301-14	11..16	CO304-45	38,40..53
200	SX	03-06	520	112	alu	20727242	1	PR301-14	11..16	AP304-45	36..40,42..54
250	EXC Enduro	95-95	520	116	acier	10717025	1	PR301-13	11..16	CO304-50	38,40..53
250	EXC Enduro	95-95	520	116	alu	20727025	1	PR301-13	11..16	AP304-50	36..40,42..54
250	EXC Enduro	96-97	520	118	acier	10717015	1	PR301-14	11..16	CO304-50	38,40..53
250	EXC Enduro	96-97	520	118	alu	20727015	1	PR301-14	11..16	AP304-50	36..40,42..54
250	EXC Enduro	98-06	520	118	acier	10717065	1	PR301-14	11..16	CO304-52	38,40..53
250	EXC Enduro	98-06	520	118	alu	20727065	1	PR301-14	11..16	AP304-52	36..40,42..54
250	EXC Enduro / EXC TPI	07-17	520	118	acier	10717015	1	PR301-14	11..16	CO304-50	38,40..53
250	EXC Enduro / EXC TPI	07-17	520	118	alu	20727015	1	PR301-14	11..16	AP304-50	36..40,42..54
250	EXC Enduro / EXC TPI	07-17	520	118	stealth	40717015	1	PR301-14	11..16	CO304SO-50	38,40..53
250	EXC Enduro / EXC TPI	07-17	520	118	stealth	4G717015	1	PR301-14	11..16	CO304SG-50	38,40..53
250	EXC TPI	18-21	520	116	acier	10717025	1	PR301-13	11..16	CO304-50	38,40..53
250	EXC TPI	18-21	520	116	alu	20727025	1	PR301-13	11..16	AP304-50	36..40,42..54
250	EXC TPI	18-21	520	116	stealth	40717025	1	PR301-13	11..16	CO304SO-50	38,40..53
250	EXC TPI	18-21	520	116	stealth	4G717025	1	PR301-13	11..16	CO304SG-50	38,40..53
250	EXC TPI	22->	520	118	acier	10717075	1	PR301-13	11..16	CO304-52	38,40..53
250	EXC TPI	22->	520	118	alu	20727075	1	PR301-13	11..16	AP304-52	36..40,42..54
250	EXC TPI	22->	520	118	stealth	40717075	1	PR301-13	11..16	CO304SO-52	38,40..53
250	EXC TPI	22->	520	118	stealth	4G717075	1	PR301-13	11..16	CO304SG-52	38,40..53
250	EXC-F 4T	02-09	520	118	acier	10717075	1	PR301-13	11..16	CO304-52	38,40..53
250	EXC-F 4T	02-09	520	118	alu	20727075	1	PR301-13	11..16	AP304-52	36..40,42..54
250	EXC-F 4T	10-16	520	116	acier	10717025	1	PR301-13	11..16	CO304-50	38,40..53
250	EXC-F 4T	10-16	520	116	alu	20727025	1	PR301-13	11..16	AP304-50	36..40,42..54
250	EXC-F 4T	10-16	520	116	stealth	40717025	1	PR301-13	11..16	CO304SO-50	38,40..53
250	EXC-F 4T	10-16	520	116	stealth	4G717025	1	PR301-13	11..16	CO304SG-50	38,40..53
250	EXC-F 4T	17->	520	116	acier	10717075	1	PR301-13	11..16	CO304-52	38,40..53
250	EXC-F 4T	17->	520	116	alu	20727075	1	PR301-13	11..16	AP304-52	36..40,42..54
250	EXC-F 4T	17->	520	116	stealth	40717075	1	PR301-13	11..16	CO304SO-52	38,40..53
250	EXC-F 4T	17->	520	116	stealth	4G717075	1	PR301-13	11..16	CO304SG-52	38,40..53
250	FREERIDE R	13-17	520	110	acier	10712005	1	PR301-14	11..16	CO307-46	46,48
250	FREERIDE R	13-17	520	110	alu	20722005	1	PR301-14	11..16	AP307-46	46,48
250	FREERIDE F	18->	520	110	acier	10714005	1	PR301-12	11..16	CO307-48	46,48
250	FREERIDE F	18->	520	110	alu	20724005	1	PR301-12	11..16	AP307-48	46,48
250	GS	85-89	520	118	alu	20727051	1	PR301-13	11..16	AP303-52	45,48,50,52,54
250	GS	90-91	520	118	alu	20727071	1	PR301-13	11..16	AP304-52	36..40,42..54
250	GS	92-94	520	118	alu	20727011	1	PR301-14	11..16	AP304-50	36..40,42..54
250	MX	85-89	520	118	alu	20727051	1	PR301-13	11..16	AP303-52	45,48,50,52,54
250	MX	90-91	520	118	alu	20727061	1	PR301-14	11..16	AP304-52	36..40,42..54
250	MX	92-94	520	118	alu	20727011	1	PR301-14	11..16	AP304-50	36..40,42..54
250	SX	95-96	520	116	alu	20727022	1	PR301-13	11..16	AP304-50	36..40,42..54
250	SX	97-03	520	118	alu	20727012	1	PR301-14	11..16	AP304-50	36..40,42..54
250	SX	04-04	520	116	alu	20727022	1	PR301-13	11..16	AP304-50	36..40,42..54
250	SX	0-16	520	114	alu	10713002	1	PR301-13	11..16	CO304-48	38,40..53
250	SX	0-16	520	114	alu	20723002	1	PR301-13	11..16	AP304-48	36..40,42..54



Cyl	Modèle	Année	CHAÎNE		KIT			PIGNON		COURONNE	
			Pas	Maillons	Matériau	RÉFÉRENCE Racine Qualité Attache	Référence	Nb dents dispos	Référence	Nb dents dispos	
250	SX	0-16	520	114	stealth ■	4071300 2 1	PR301-13	11..16	CO304SO-48	38,40..53	
250	SX	0-16	520	114	stealth ■	4671300 2 1	PR301-13	11..16	CO304SG-48	38,40..53	
250	SX	17-20	520	118	acier	1071701 2 1	PR301-14	11..16	CO304-50	38,40..53	
250	SX	17-20	520	118	alu	2072701 2 1	PR301-14	11..16	AP304-50	36..40,42..54	
250	SX	21->	520	116	acier	1071712 2 1	PR301-14	11..16	CO304-49	38,40..53	
250	SX	21->	520	116	alu	2072712 2 1	PR301-14	11..16	AP304-49	36..40,42..54	
250	SX	21->	520	116	stealth ■	4071712 2 1	PR301-14	11..16	CO304SO-49	38,40..53	
250	SX	21->	520	116	stealth ■	4671712 2 1	PR301-14	11..16	CO304SG-49	38,40..53	
250	SX-F	05-12	520	114	alu	1071300 2 1	PR301-13	11..16	CO304-48	38,40..53	
250	SX-F	05-12	520	114	alu	2072300 2 1	PR301-13	11..16	AP304-48	36..40,42..54	
250	SX-F	13-16	520	116	acier	1071702 2 1	PR301-13	11..16	CO304-50	38,40..53	
250	SX-F	13-16	520	116	alu	2072702 2 1	PR301-13	11..16	AP304-50	36..40,42..54	
250	SX-F	17->	520	118	acier	1071301 2 1	PR301-14	11..16	CO304-51	38,40..53	
250	SX-F	17->	520	118	alu	2072301 2 1	PR301-14	11..16	AP304-51	36..40,42..54	
250	SX-F	17->	520	118	stealth ■	4071301 2 1	PR301-14	11..16	CO304SO-51	38,40..53	
250	SX-F	17->	520	118	stealth ■	4671301 2 1	PR301-14	11..16	CO304SG-51	38,40..53	
300	EXC Enduro	95-97	520	118	acier	1071701 5 1	PR301-14	11..16	CO304-50	38,40..53	
300	EXC Enduro	95-97	520	118	alu	2072701 5 1	PR301-14	11..16	AP304-50	36..40,42..54	
300	EXC Enduro	98-06	520	118	acier	1071706 5 1	PR301-14	11..16	CO304-52	38,40..53	
300	EXC Enduro	98-06	520	118	alu	2072706 5 1	PR301-14	11..16	AP304-52	36..40,42..54	
300	EXC Enduro / EXC TPI	07-22	520	116	acier	1071702 5 1	PR301-13	11..16	CO304-50	38,40..53	
300	EXC Enduro / EXC TPI	07-22	520	116	alu	2072702 5 1	PR301-13	11..16	AP304-50	36..40,42..54	
300	EXC Enduro / EXC TPI	07-22	520	116	stealth ■	4071702 5 1	PR301-13	11..16	CO304SO-50	38,40..53	
300	EXC Enduro / EXC TPI	07-22	520	116	stealth ■	4671702 5 1	PR301-13	11..16	CO304SG-50	38,40..53	
300	GS	90-91	520	118	alu	2072707 5 1	PR301-13	11..16	AP304-52	36..40,42..54	
300	GS	92-94	520	118	acier	1071701 5 1	PR301-14	11..16	CO304-50	38,40..53	
300	GS	92-94	520	118	alu	2072701 5 1	PR301-14	11..16	AP304-50	36..40,42..54	
300	MX	92-94	520	118	alu	2072701 2 1	PR301-14	11..16	AP304-50	36..40,42..54	
300	SX	93-95	520	118	alu	2072701 2 1	PR301-14	11..16	AP304-50	36..40,42..54	
350	FREERIDE	13->	520	110	acier	1071400 5 1	PR301-12	11..16	CO307-48	46,48	
350	FREERIDE	13->	520	110	alu	2072400 5 1	PR301-12	11..16	AP307-48	46,48	
350	GS	85-90	520	118	acier	1071701 5 1	PR301-14	11..16	CO304-50	38,40..53	
350	GS	85-90	520	118	alu	2072701 5 1	PR301-14	11..16	AP304-50	36..40,42..54	
350	EXC-F	12-22	520	116	acier	1071707 5 1	PR301-13	11..16	CO304-52	38,40..53	
350	EXC-F	12-22	520	116	alu	2072707 5 1	PR301-13	11..16	AP304-52	36..40,42..54	
350	EXC-F	12-22	520	116	stealth ■	4071707 5 1	PR301-13	11..16	CO304SO-52	38,40..53	
350	EXC-F	12-22	520	116	stealth ■	4671707 5 1	PR301-13	11..16	CO304SG-52	38,40..53	
350	SX-F	11-19	520	118	acier	1071701 2 1	PR301-14	11..16	CO304-50	38,40..53	
350	SX-F	11-19	520	118	alu	2072701 2 1	PR301-14	11..16	AP304-50	36..40,42..54	
350	SX-F	11-19	520	118	stealth ■	4071701 2 1	PR301-14	11..16	CO304SO-50	38,40..53	
350	SX-F	11-19	520	118	stealth ■	4671701 2 1	PR301-14	11..16	CO304SG-50	38,40..53	
350	SX-F	20->	520	118	acier	1071301 2 1	PR301-14	11..16	CO304-51	38,40..53	
350	SX-F	20->	520	118	alu	2072301 2 1	PR301-14	11..16	AP304-51	36..40,42..54	
350	SX-F	20->	520	118	stealth ■	4071301 2 1	PR301-14	11..16	CO304SO-51	38,40..53	
350	SX-F	20->	520	118	stealth ■	4671301 2 1	PR301-14	11..16	CO304SG-51	38,40..53	
360	EXC	95-97	520	118	acier	1071708 5 1	PR301-14	11..16	CO304-50	38,40..53	
360	EXC	95-97	520	118	alu	2072708 5 1	PR301-14	11..16	AP304-50	36..40,42..54	
360	SX	96-97	520	118	alu	2072708 2 1	PR301-14	11..16	AP304-50	36..40,42..54	
380	EXC Enduro	98-99	520	118	alu	2072701 5 1	PR301-14	11..16	AP304-50	36..40,42..54	
380	SX Motocross	98->	520	118	alu	2072701 2 1	PR301-14	11..16	AP304-50	36..40,42..54	
400	EGS-E LC4	96-97	520	118	alu	2072709 5 1	PR303-15	13..17	AP304-45	36..40,42..54	
400	EXC Racing	00->	520	118	acier	1071701 5 1	PR301-14	11..16	CO304-50	38,40..53	
400	EXC Racing	00->	520	118	alu	2072701 5 1	PR301-14	11..16	AP304-50	36..40,42..54	
400	SX Racing	00-02	520	118	acier	1071701 2 1	PR301-14	11..16	CO304-50	38,40..53	
400	SX Racing	00-02	520	118	alu	2072701 2 1	PR301-14	11..16	AP304-50	36..40,42..54	
400	LSE LC4	97->	520	118	alu	2072709 5 1	PR303-15	13..17	AP304-45	36..40,42..54	
400	SC	95-99	520	118	acier	1071708 2 1	PR303-14	13..17	CO304-50	38,40..53	
400	SC	95-99	520	118	alu	2072708 2 1	PR303-14	13..17	AP304-50	36..40,42..54	
400	SXC	98->	520	118	acier	1071710 2 1	PR303-14	13..17	CO304-45	38,40..53	
400	SXC	98->	520	118	alu	2072710 2 1	PR303-14	13..17	AP304-45	36..40,42..54	

TRANSMISSION

Cyl	Modèle	Année	CHAÎNE		KIT			PIGNON		COURONNE	
			Pas	Maillons	Matériau	RÉFÉRENCE Racine Qualité Attache	Référence	Nb dents dispos	Référence	Nb dents dispos	
KTM											
450	EXC-F	03-07	520	118	acier	10717015	1	PR301-14	11..16	CO304-50	38,40..53
450	EXC-F	03-07	520	118	alu	20727015	1	PR301-14	11..16	AP304-50	36..40,42..54
450	EXC-F	08-20	520	118	acier	10717195	1	PR301-14	11..16	CO304-52	38,40..53
450	EXC-F	08-20	520	118	alu	20727195	1	PR301-14	11..16	AP304-52	36..40,42..54
450	EXC-F	08-20	520	118	stealth	40717195	1	PR301-14	11..16	CO304SO-52	38,40..53
450	EXC-F	08-20	520	118	stealth	4G717195	1	PR301-14	11..16	CO304SG-52	38,40..53
450	SMR	21->	520	114	acier	10717102	1	PR303-14	13..17	CO304-45	38,40..53
450	SMR	21->	520	114	alu	20727102	1	PR303-14	13..17	AP304-45	36..40,42..54
450	SX-F	03-12	520	118	acier	10717192	1	PR301-14	11..16	CO304-52	38,40..53
450	SX-F	03-12	520	118	alu	20727192	1	PR301-14	11..16	AP304-52	36..40,42..54
450	SX-F	13-15	520	118	acier	10717012	1	PR301-14	11..16	CO304-50	38,40..53
450	SX-F	13-15	520	118	alu	20727012	1	PR301-14	11..16	AP304-50	36..40,42..54
450	SX-F	13-15	520	118	stealth	40717012	1	PR301-14	11..16	CO304SO-50	38,40..53
450	SX-F	13-15	520	118	stealth	4G717012	1	PR301-14	11..16	CO304SG-50	38,40..53
450	SX-F	16-19	520	114	alu	10713002	1	PR301-13	11..16	CO304-48	38,40..53
450	SX-F	16-19	520	114	alu	20723002	1	PR301-13	11..16	AP304-48	36..40,42..54
450	SX-F	16-19	520	114	stealth	40713002	1	PR301-13	11..16	CO304SO-48	38,40..53
450	SX-F	16-19	520	114	stealth	4G713002	1	PR301-13	11..16	CO304SG-48	38,40..53
450	SX-F	20->	520	118	alu	10713032	1	PR301-13	11..16	CO304-49	38,40..53
450	SX-F	20->	520	118	alu	20723032	1	PR301-13	11..16	AP304-49	36..40,42..54
450	SX-F	20->	520	118	stealth	40713032	1	PR301-13	11..16	CO304SO-49	38,40..53
450	SX-F	20->	520	118	stealth	4G713032	1	PR301-13	11..16	CO304SG-49	38,40..53
500	EXC-F	12-20	520	118	acier	10717015	1	PR301-14	11..16	CO304-50	38,40..53
500	EXC-F	12-20	520	118	alu	20727015	1	PR301-14	11..16	AP304-50	36..40,42..54
500	EXC-F	12-20	520	118	stealth	40717015	1	PR301-14	11..16	CO304SO-50	38,40..53
500	EXC-F	12-20	520	118	stealth	4G717015	1	PR301-14	11..16	CO304SG-50	38,40..53
500	MX	88-93	520	118	alu	20727122	1	PR301-14	11..16	AP303-50	45,48,50,52,54
500	MX LC4	90-	520	118	alu	20727042	1	PR301-14	11..16	AP303-52	45,48,50,52,54
500	SX	93-95	520	118	alu	20727122	1	PR301-14	11..16	AP303-50	45,48,50,52,54
505	SX-F	08->	520	118	acier	10717192	1	PR301-14	11..16	CO304-52	38,40..53
505	SX-F	08->	520	118	alu	20727192	1	PR301-14	11..16	AP304-52	36..40,42..54
520	EXC	99->	520	118	acier	10717015	1	PR301-14	11..16	CO304-50	38,40..53
520	EXC	99->	520	118	alu	20727015	1	PR301-14	11..16	AP304-50	36..40,42..54
520	SX Racing	00-00	520	118	acier	10717015	1	PR301-14	11..16	CO304-50	38,40..53
520	SX Racing	00-00	520	118	alu	20727015	1	PR301-14	11..16	AP304-50	36..40,42..54
520	SX Racing	01-02	520	118	acier	10717205	1	PR301-14	11..16	CO304-48	38,40..53
520	SX Racing	01-02	520	118	alu	20727205	1	PR301-14	11..16	AP304-48	36..40,42..54
525	EXC	03-07	520	118	acier	10717205	1	PR301-14	11..16	CO304-48	38,40..53
525	EXC	03-07	520	118	alu	20727205	1	PR301-14	11..16	AP304-48	36..40,42..54
525	SX Racing	03-07	520	118	acier	10717205	1	PR301-14	11..16	CO304-48	38,40..53
525	SX Racing	03-07	520	118	alu	20727205	1	PR301-14	11..16	AP304-48	36..40,42..54
530	EXC-F	08->	520	118	acier	10717015	1	PR301-14	11..16	CO304-50	38,40..53
530	EXC-F	08->	520	118	alu	20727015	1	PR301-14	11..16	AP304-50	36..40,42..54
540	GS	98-99	520	118	alu	20727005	1	PR303-15	13..17	AP304-50	36..40,42..54
540	SXC	98->	520	118	acier	10717105	1	PR303-14	13..17	CO304-45	38,40..53
540	SXC	98->	520	118	alu	20727105	1	PR303-14	13..17	AP304-45	36..40,42..54
600	GS LC4	88-90	520	118	alu	20727135	1	PR301-15	11..16	AP303-50	45,48,50,52,54
600	GS LC4	91-92	520	118	alu	20727145	1	PR303-15	13..17	AP303-50	45,48,50,52,54
600	MX LC4	88-90	520	118	alu	20727042	1	PR301-14	11..16	AP303-52	45,48,50,52,54
620	EGS Enduro LC4	96-97	520	118	alu	20727035	1	PR303-16	13..17	AP304-40	36..40,42..54
620	LSE LC4	97->	520	118	alu	20727035	1	PR303-16	13..17	AP304-40	36..40,42..54
620	SX	94-97	520	118	alu	20727005	1	PR303-15	13..17	AP304-50	36..40,42..54
625	SXC	03->	520	110	alu	20726605	1	PR303-16	13..17	AP304-40	36..40,42..54
640	LC4 Adventure /R	94->	520	110	acier	10717006	1	PR303-15	13..17	CO304-42	38,40..53
640	LC4 Adventure /R	94->	520	110	alu	20727006	1	PR303-15	13..17	AP304-42	36..40,42..54
640	LC4 Enduro /E	96->	520	118	alu	20727036	1	PR303-16	13..17	AP304-40	36..40,42..54
640	LC4 Enduro /E (18 lit.)	97->	520	118	alu	20727036	1	PR303-16	13..17	AP304-40	36..40,42..54
660	SMC	03->	520	108	acier	10717176	1	PR303-16	13..17	CO304-38	38,40..53
660	SMC	03->	520	108	alu	20727176	1	PR303-16	13..17	AP304-38	36..40,42..54



Cyl	Modèle	Année	CHAÎNE		KIT			PIGNON		COURONNE	
			Pas	Maillons	Matériau	RÉFÉRENCE Racine Qualité Attache	Référence	Nb dents dispos	Référence	Nb dents dispos	
690	Enduro R	08->	520	118	acier	1071709 6 1	PR303-15	13..17	CO304-45	38,40..53	
690	SMC R	12-16	520	118	acier	1071716 6 1	PR303-16	13..17	CO304-42	38,40..53	
950	Superenduro R	05-08	525	118	acier	1071801 6 2	PR400-16	15..17	CK501-45	42,45	
990	Adventure / R / S / ABS	07-13	525	118	acier	1071802 6 2	PR400-16	15..17	CK501-42	42,45	
KYMCO											
50	KXR	04->	428	74	acier	1090407 1 1	PA200-16	13..17	CP101-28	28	
50	Maxxer	05->16	428	74	acier	1090407 1 1	PA200-16	13..17	CP101-28	28	
50	MXER	02-06	520	78	acier	1090403 1 1	PT315-14	14..16	CX402-30	30	
50	MXU Reverse	07-16	520	86	acier	1090408 1 1	PT315-14	14..16	CX402-30	30	
150	MXER	02->	520	78	acier	1090404 5 1	PT316-14	14..16	CX402-30	30	
250	KXR / MXU - 300 KXR	03->	520	94	acier	1090405 5 1	PT317-14	14..17	CX403-38	36,38	
300	Maxxer	06-13	520	94	acier	1090405 5 1	PT317-14	14..17	CX403-38	36,38	
MONTESA											
	310/311 Cota	-	520	98	alu	2078100 1 1	PU302-10	10	AS303-40	40	
	314 R / 315 R	-	520	100	alu	2078110 1 1			AS303-40	40	
	349 Cota	-	520	100	acier	1078120 1 1	PU302-10	10	CR301-38	38,43	
POLARIS											
250	Trail Blazer /ES / Trail Boss	95-99	520	88	acier	1090805 5 1	PT318-12	11..13	CX404-42	30,34,36,38,40,42,43	
250	Trail Blazer (<= 15/7/00)	00-00	520	86	acier	1090803 5 1	PT318-11	11..13	CX404-38	30,34,36,38,40,42,43	
250	Trail Blazer (15/7/00 =>)	00-01	520	86	acier	1090806 5 1	PT318-11	11..13	CX404-36	30,34,36,38,40,42,43	
250	Trail Blazer	02-03	520	76	acier	1090807 5 1	PT318-11	11..13	CX404-36	30,34,36,38,40,42,43	
250	Trail Boss	88-93	520	86	acier	1090808 5 1	PT318-13	11..13	CX404-38	30,34,36,38,40,42,43	
250	Xplorer 4x4	01-02	520	80	acier	1090810 5 1	PT318-12	11..13	CX404-42	30,34,36,38,40,42,43	
300	2x4 / Xpress	95-99	520	86	acier	1090811 5 1	PT318-12	11..13	CX404-38	30,34,36,38,40,42,43	
325	Trail Boss 2x4	00-00	520	80	acier	1090812 5 1	PT318-11	11..13	CX404-42	30,34,36,38,40,42,43	
325	- 330 Trail Boss 2x4	01-03	520	78	acier	1090813 5 1	PT318-11	11..13	CX404-40	30,34,36,38,40,42,43	
400	L2x4/LSport/XP2x4/350LT.B.2x4	90-99	520	84	acier	1090801 5 1	PT318-13	11..13	CX404-34	30,34,36,38,40,42,43	
400	L Sport	94-95	520	84	acier	1090814 5 1	PT318-12	11..13	CX404-34	30,34,36,38,40,42,43	
400	Scrambler 2x4 / Trail Blazer 2x4	00-04	520	76	acier	1090815 5 1	PT318-13	11..13	CX404-36	30,34,36,38,40,42,43	
425	Magnum 2x4	95-98	520	86	acier	1090811 5 1	PT318-12	11..13	CX404-38	30,34,36,38,40,42,43	
450	Outlaw	08->	520	98	acier	1090816 5 1	PR301-14	11..16	CX405-38	37,38	
500	Predator E 2x4	03-04	520	94	acier	1090850 5 1	PA510-14	13..16	CX405-37	37,38	
500	Predator	05->	520	94	acier	1090851 5 1	PA510-14	13..16	CX405-38	37,38	
500	Scrambler	00-10	520	76	acier	1090815 5 1	PT318-13	11..13	CX404-36	30,34,36,38,40,42,43	
525	Outlaw	08->	520	98	acier	1090816 5 1	PR301-14	11..16	CX405-38	37,38	
RIEJU											
250	MR	18-20	520	114	acier	1093258 5 1	PT313-13	12,13	CE206-49	40..53	
250	MR	18-20	520	114	alu	2093258 5 1	PT313-13	12,13	AF206-49	39,41..53	
250	MR	18-20	520	114	stealth ■	4R93258 5 1	PT313-13	12,13	CE206SR-49	40..53	
300	MR / et MR Ranger	21->	520	114	acier	1093252 5 1	PT313-13	12,13	CE206-48	40..53	
300	MR / et MR Ranger	21->	520	114	alu	2093252 5 1	PT313-13	12,13	AF206-48	39,41..53	
300	MR / et MR Ranger	21->	520	114	stealth ■	4R93252 5 1	PT313-13	12,13	CE206SR-48	40..53	
SHERCO											
50	Sherco Enduro / SE-R	03-18	420	134	acier	1014100 2 1	PT119-12	11..15	CO104-56	50,56	
125	SE-R	18->	520	114	acier	1015112 5 1	PT216-13	13,14	CE206-51	40..53	
125	SE-R	18->	520	114	alu	2015112 5 1	PT216-13	13,14	AF206-51	39,41..53	
125	SE-R	18->	520	114	stealth ■	4B15112 5 1	PT216-13	13,14	CE206SB-51	40..53	
125	Sherco 1.25	03->	520	104	alu	2015100 2 1	PT309-09	9	AU303-44	40..4244	
200	Sherco 2.0	03->	520	104	alu	2015100 2 1	PT306-09	9,10	AU303-44	40..4244	
250	Sherco	94-01	520	100	alu	2015103 2 1	PT306-10	9,10	AU303-42	40..4244	
250	Sherco 2.5	02-03	520	104	alu	2015104 2 1	PT306-10	9,10	AU320-44	42..44,46	
250	/ 300 SE-R 2T	14-20	520	114	acier	1015111 5 1	PT319-14	13,14	CE206-49	40..53	
250	/ 300 SE-R 2T	14-20	520	114	alu	2015111 5 1	PT319-14	13,14	AF206-49	39,41..53	
250	/ 300 SE-R 2T	14-20	520	114	stealth ■	4B15111 5 1	PT319-14	13,14	CE206SB-49	40..53	
250	SE-R 2T	21->	520	114	acier	1015115 5 1	PT300-13	13,14	CE206-50	40..53	
250	SE-R 2T	21->	520	114	alu	2015115 5 1	PT300-13	13,14	AF206-50	39,41..53	
250	SE-R 2T	21->	520	114	stealth ■	4B15115 5 1	PT300-13	13,14	CE206SB-50	40..53	
250	SEF-R 4T	14-20	520	114	acier	1015110 5 1	PT216-13	13,14	CE206-49	40..53	
250	SEF-R 4T	14-20	520	114	alu	2015110 5 1	PT216-13	13,14	AF206-49	39,41..53	
250	SEF-R 4T	14-20	520	114	stealth ■	4B15110 5 1	PT216-13	13,14	CE206SB-49	40..53	

TRANSMISSION

Cyl	Modèle	Année	CHAÎNE		KIT			PIGNON		COURONNE	
			Pas	Maillons	Matériau	RÉFÉRENCE Racine Qualité Attache	Référence	Nb dents dispos	Référence	Nb dents dispos	
SHERCO											
250	SEF-R 4T	21->	520	114	acier	1015116 5 1	PT300-13	13,14	CE206-49	40.53	
250	SEF-R 4T	21->	520	114	alu	2015116 5 1	PT300-13	13,14	AF206-49	39,41..53	
250	SEF-R 4T	21->	520	114	stealth■	4B15116 5 1	PT300-13	13,14	CE206SB-49	40.53	
290	Sherco 2.9	03->	520	104	alu	2015104 2 1			AU320-44	42..44,46	
300	SE-R 2T	21->	520	114	acier	1015117 5 1	PT300-13	13,14	CE206-48	40.53	
300	SE-R 2T	21->	520	114	alu	2015117 5 1	PT300-13	13,14	AF206-48	39,41..53	
300	SE-R 2T	21->	520	114	stealth■	4B15117 5 1	PT300-13	13,14	CE206SB-50	40.53	
300	SEF-R 4T	14-20	520	114	acier	1015113 5 1	PT216-13	13,14	CE206-48	40.53	
300	SEF-R 4T	14-20	520	114	alu	2015113 5 1	PT216-13	13,14	AF206-48	39,41..53	
300	SEF-R 4T	14-20	520	114	stealth■	4B15113 5 1	PT216-13	13,14	CE206SB-48	40.53	
300	SEF-R 4T	21->	520	114	acier	1015117 5 1	PT300-13	13,14	CE206-48	40.53	
300	SEF-R 4T	21->	520	114	alu	2015117 5 1	PT300-13	13,14	AF206-48	39,41..53	
300	SEF-R 4T	21->	520	114	stealth	4B15117 5 1	PT300-13	13,14	CE206SB-50	40.53	
450	i / 510 i	04->	520	114	alu	2015400 2 1			AF206-48	39,41..53	
450	500 SEF-R	15-22	520	116	acier	1015114 5 1	PT319-14	13,14	CE206-50	40.53	
450	500 SEF-R	15-22	520	116	alu	2015114 5 1	PT319-14	13,14	AF206-50	39,41..53	
450	500 SEF-R	15-22	520	116	stealth■	4B15114 5 1	PT319-14	13,14	CE206SB-50	40.53	
SUZUKI											
50	LT E, F, G, H, J, K, X, Y	84-00	420	78	acier	10700300 1	PH100-11	10..15	CE100-37	26,28..39,41..54	
50	LT A-50 K1	01-01	420	78	acier	10700310 1	PH100-11	10..15	CE100-37	26,28..39,41..54	
50	LT A-50 K2, K3, K4 QuadSport	02-04	420	78	acier	10700320 1	PH100-10	10..15	CE112-37	37	
65	RM	03-07	420	110	alu	2083065 2 1	PK100-13	12..16	AH107-47	46,47	
80	LT K...K4	89-04	520	36	acier	1070035 1 1	PC104-10	10	CE110-22	22	
80	RM G.R.	96->	428	122	alu	2083051 2 1	PI200-13	12..15	AF104-48	47..54	
80	RM P.R.	89-01	428	118	alu	2083021 2 1	PI200-14	12..15	AF104-48	47..54	
85	RM P.R.	02-12	428	118	acier	1070053 2 1	PI200-14	12..15	CE104-47	44,47,54	
85	RM P.R.	02-12	428	118	alu	2083053 2 1	PI200-14	12..15	AF104-47	47..54	
85	RM L G.R.	02-22	428	124	acier	1070052 2 1	PI200-13	12..15	CE104-47	44,47,54	
85	RM L G.R.	02-22	428	124	alu	2083052 2 1	PI200-13	12..15	AF104-47	47..54	
110	DRZ K1-K2	01-02	420	90	acier	1070080 2 1	PM101-14	12..15	CE100-37	26,28..39,41..54	
110	DRZ K3	03-03	420	90	acier	1070081 2 1	PE101-15	13..16	CE100-37	26,28..39,41..54	
125	DRZ-L	03-18	428	134	acier	1070148 1 1	PC201-14	14..16	CE212-57	51,57	
125	RM	88-91	520	114	alu	2083100 2 1	PC203-13	11..14	AF203-51	44,46..52	
125	RM	92-93	520	114	alu	2083101 2 1	PC203-12	11..14	AF203-49	44,46..52	
125	RM	94-96	520	112	alu	2083102 2 1	PC203-12	11..14	AF203-49	44,46..52	
125	RM	97-99	520	114	alu	2083103 2 1	PC203-12	11..14	AF203-50	44,46..52	
125	RM	00-03	520	114	alu	2083104 2 1	PC203-12	11..14	AF203-49	44,46..52	
125	RM	04-05	520	114	alu	2083105 2 1	PC203-12	11..14	AF203-50	44,46..52	
125	RM	06-08	520	114	acier	1070106 2 1	PC203-12	11..14	CE203-51	39,41,43,44,46...53	
125	RM	06-08	520	114	alu	2083106 2 1	PC203-12	11..14	AF203-51	44,46..52	
250	DRZ	01->	520	112	acier	1070159 5 1	PC303-13	12..15	CE206-49	40.53	
250	DRZ	01->	520	112	alu	2083159 5 1	PC303-13	12..15	AF206-49	39,41..53	
250	RM	89-92	520	112	alu	2083130 2 1	PC303-13	12..15	AF203-49	44,46..52	
250	RM	93-93	520	116	acier	1070129 2 1	PC303-13	12..15	CE203-49	39,41,43,44,46...53	
250	RM	93-93	520	116	alu	2083131 2 1	PC303-13	12..15	AF203-49	44,46..52	
250	RM	94-96	520	112	acier	1070136 2 1	PC303-13	12..15	CE203-49	39,41,43,44,46...53	
250	RM	94-96	520	112	alu	2083136 2 1	PC303-13	12..15	AF203-49	44,46..52	
250	RM	97-98	520	114	acier	1070133 2 1	PC303-13	12..15	CE203-50	39,41,43,44,46...53	
250	RM	97-98	520	114	alu	2083133 2 1	PC303-13	12..15	AF203-50	44,46..52	
250	RM	99-00	520	112	acier	1070134 2 1	PC303-13	12..15	CE203-48	39,41,43,44,46...53	
250	RM	99-00	520	112	alu	2083134 2 1	PC303-13	12..15	AF203-48	44,46..52	
250	RM	01-03	520	112	acier	1070137 2 1	PC303-13	12..15	CE203-49	39,41,43,44,46...53	
250	RM	01-03	520	112	alu	2083137 2 1	PC303-13	12..15	AF203-49	44,46..52	
250	RM	04-09	520	114	acier	1070140 2 1	PC303-13	12..15	CE203-50	39,41,43,44,46...53	
250	RM	04-09	520	114	alu	2083140 2 1	PC303-13	12..15	AF203-50	44,46..52	
250	RMX	89-02	520	116	alu	2083131 5 1	PC303-13	12..15	AF203-49	44,46..52	
250	RM-Z (K4-5-6)	04-06	520	114	acier	1070145 2 1	PC301-13	13..15	CG204-48	42,44,47..53	
250	RM-Z (K4-5-6)	04-06	520	114	alu	2083145 2 1	PC301-13	13..15	AH206-48	45..52	
250	RM-Z	07-09	520	114	acier	1070146 2 1	PC203-12	11..14	CE203-48	39,41,43,44,46...53	



Cyl	Modèle	Année	CHAÎNE		KIT			PIGNON		COURONNE	
			Pas	Maillons	Matériau	RÉFÉRENCE Racine Qualité Attache	Référence	Nb dents dispos	Référence	Nb dents dispos	
250	RM-Z	07-09	520	114	alu	2083146 2 1	PC203-12	11..14	AF203-48	44,46..52	
250	RM-Z	10-12	520	114	acier	1070147 2 1	PC203-13	11..14	CE203-49	39,41,43,44,46...53	
250	RM-Z	10-12	520	114	alu	2083147 2 1	PC203-13	11..14	AF203-49	44,46..52	
250	RM-Z	10-12	520	114	stealth ■	4G70147 2 1	PC203-13	11..14	CE203SG-49	39,41,43,44,46...53	
250	RM-Z	10-12	520	114	stealth ■	4N70147 2 1	PC203-13	11..14	CE203SN-49	39,41,43,44,46...53	
250	RM-Z	13-18	520	114	acier	1070166 2 1	PC204-13	13,14	CE203-49	39,41,43,44,46...53	
250	RM-Z	13-18	520	114	alu	2083166 2 1	PC204-13	13,14	AF203-49	44,46..52	
250	RM-Z	13-18	520	114	stealth ■	4G70166 2 1	PC204-13	13,14	CE203SG-49	39,41,43,44,46...53	
250	RM-Z	13-18	520	114	stealth ■	4N70166 2 1	PC204-13	13,14	CE203SN-49	39,41,43,44,46...53	
250	RM-Z	19->	520	114	acier	1070167 2 1	PC204-13	13,14	CE203-50	39,41,43,44,46...53	
250	RM-Z	19->	520	114	alu	2083167 2 1	PC204-13	13,14	AF203-50	44,46..52	
250	RM-Z	19->	520	114	stealth ■	4G70167 2 1	PC204-13	13,14	CE203SG-50	39,41,43,44,46...53	
250	RM-Z	19->	520	114	stealth ■	4N70167 2 1	PC204-13	13,14	CE203SN-50	39,41,43,44,46...53	
350	DR N (USA)	-	520	110	acier	1070161 5 1	PC303-14	12..15	CE203-47	39,41,43,44,46...53	
350	DR N (USA)	-	520	110	alu	2083161 5 1	PC303-14	12..15	AF203-47	44,46..52	
350	DR S (SK42B)	<-93	520	108	acier	1070160 5 1	PC303-14	12..15	CE206-43	40..53	
350	DR SE	94-95	520	110	acier	1070163 5 1	PC303-15	12..15	CE206-41	40..53	
350	DR SE	96-98	520	108	acier	1070162 5 1	PC303-15	12..15	CE203-43	39,41,43,44,46...53	
350	DR SE-X	99->	520	112	acier	1070164 5 1	PC303-15	12..15	CE203-44	39,41,43,44,46...53	
370	SP	-	520	100	acier	1070170 1 1	PC401-15	14..16	CE304-42	42	
400	DR S (T/K)	80-82	520	108	acier	1070201 5 1	PC401-16	14..16	CE206-44	40..53	
400	DR Z E	00->	520	112	acier	1070200 5 1	PC303-14	12..15	CE203-47	39,41,43,44,46...53	
400	DR Z E	00->	520	112	alu	2083200 5 1	PC303-14	12..15	AF203-47	44,46..52	
400	DR Z S	99->	520	112	acier	1070210 5 1	PC303-15	12..15	CE203-44	39,41,43,44,46...53	
400	LT-Z400 K3,K4,K5,K6,K7,K8 QuadSport	02-08	520	96	acier	1070245 5 1	PE310-14	13..16	CE310-40	39..44	
400	LT-Z400 K9,L0,L1,L2 QuadSport	09-12	520	96	acier	1070246 5 1	PE310-14	13..16	CE409-40	36,38,40	
450	LT R	06-13	520	96	acier	1070252 5 1	PE310-14	13..16	CE409-36	36,38,40	
450	RM-X	10->	520	116	acier	1070262 5 1	PC406-13	13..15	CE203-51	39,41,43,44,46...53	
450	RM-X	10->	520	116	alu	2083262 5 1	PC406-13	13..15	AF203-51	44,46..52	
450	RM-Z	05-07	520	116	acier	1070260 2 1	PC406-14	13..15	CE203-49	39,41,43,44,46...53	
450	RM-Z	05-07	520	116	alu	2083260 2 1	PC406-14	13..15	AF203-49	44,46..52	
450	RM-Z	08-12	520	114	acier	1070261 2 1	PC406-13	13..15	CE203-50	39,41,43,44,46...53	
450	RM-Z	08-12	520	114	alu	2083261 2 1	PC406-13	13..15	AF203-50	44,46..52	
450	RM-Z	13-22	520	114	acier	1070263 2 1	PC407-13	13	CE203-50	39,41,43,44,46...53	
450	RM-Z	13-22	520	114	alu	2083263 2 1	PC407-13	13	AF203-50	44,46..52	
450	RM-Z	13-22	520	114	stealth ■	4G70263 2 1	PC407-13	13	CE203SG-50	39,41,43,44,46...53	
450	RM-Z	13-22	520	114	stealth ■	4N70263 2 1	PC407-13	13	CE203SN-50	39,41,43,44,46...53	
500	DR S (X, Z)	81-82	520	106	acier	1070303 5 1	PC401-15	14..16	CE401-45	37,41,43,45,48	
500	RM	83-84	520	112	acier	1073212 2 1	PC500-14	14	CE501-46	42,47,48	
TM											
80	Cross / Enduro P.R. (#428)	01-05	428	130	alu	2065080 2 1	PT117-16	16,17	AU106-52	52,56	
85	Cross / Enduro G.R. (#428)	02-05	428	132	alu	2065000 2 1	PT117-16	16,17	AU106-56	52,56	
85	Cross / Enduro G.R. (#520)	02-05	520	116	alu	2065081 2 1	PT214-12	12,13	AU314-52	49..52	
85	MX Junior (#428)	14->	428	128	alu	2065010 2 1	PT117-16	16,17	AU112-53	53,60	
125	EN Enduro <04/00	98-99	520	116	alu	2065100 5 1	PT214-13	12,13	AU314-51	49..52	
125	EN Enduro 05/00 >	00-11	520	116	alu	2065101 5 1	PT215-13	12,13	AU314-52	49..52	
125	EN Enduro	12-13	520	114	alu	2065103 5 1	PT215-12	12,13	AU314-50	49..52	
125	MX Cross	03-12	520	116	alu	2065102 2 1	PT215-13	12,13	AU314-51	49..52	
125	MX Cross	13->	520	114	alu	2065103 2 1	PT215-12	12,13	AU314-50	49..52	
250	EN Enduro / MX Cross	01-03	520	116	alu	2065200 5 1	PT312-13	13	AU314-52	49..52	
250	EN Enduro / MX Cross 4T	02-02	520	116	alu	2065201 5 1	PT312-13	13	AU314-51	49..52	
250	EN Enduro 4T	03->	520	116	alu	2065202 5 1	PT312-13	13	AU314-50	49..52	
250	EN FI 4T	11->	520	116	alu	2065204 5 1	PT417-13	13	AU314-52	49..52	
250	EN FI 4T	11->	520	116	stealth ■	4B65204 5 1	PT417-13	13	CX314SB-52	49..52	
250	MX FI	12->	520	116	alu	2065203 5 1	PT417-13	13	AU314-51	49..52	
300	EN Enduro / MX Cross	01-02	520	116	alu	2065200 5 1	PT312-13	13	AU314-52	49..52	
300	EN FI 4T	17->	520	116	alu	2065203 5 1	PT417-13	13	AU314-51	49..52	
300	EN FI 4T	17->	520	116	stealth ■	4B65203 5 1	PT417-13	13	CX314SB-51	49..52	
300	MX Cross	03->	520	116	alu	2065201 5 1	PT312-13	13	AU314-51	49..52	
400	/ 450 / 530 EN Enduro / MX Cross 4T	02->	520	116	alu	2065202 6 1	PT312-13	13	AU314-50	49..52	

TRANSMISSION

Cyl	Modèle	Année	CHAÎNE		KIT			PIGNON		COURONNE	
			Pas	Maillons	Matériau	RÉFÉRENCE Racine Qualité Attache	Référence	Nb dents dispos	Référence	Nb dents dispos	
VOR											
400	EN, MX	01-01	520	114	alu	2093804 5 1	PT314-14	13,14	AU209-50	40,48,50	
400	EN, MX	02->	520	114	alu	2093800 5 1	PT314-13	13,14	AU209-50	40,48,50	
530	EN	02-02	520	116	alu	2093801 5 1	PT314-13	13,14	AU209-50	40,48,50	
530	MX	02-02	520	116	alu	2093802 5 1	PT314-14	13,14	AU209-50	40,48,50	
YAMAHA											
50	TT-R 50 E	06-17	420	80	acier	1051024 0 1	PK100-13	12..16	CC101-37	28..32,35..39,41,43,45,48	
65	YZ	18->	420	118	alu	2081035 2 1	PB103-14	13,14	AD114-47	46..48	
80	PW (21W/4BC)	83->	420	84	acier	1051029 0 1	PK100-15	12..16	CC101-37	28..32,35..39,41,43,45,48	
80	YZ P.R.	93->	428	118	alu	2081050 2 1	PI200-14	12..15	AF104-47	47..54	
80	YZ G.R.	94->	428	120	alu	2081051 2 1	PI200-13	12..15	AF104-47	47..54	
85	YZ P.R.	02-15	428	118	acier	1051061 2 1	PB202-14	13..20	CE104-47	44,47,54	
85	YZ P.R.	02-15	428	118	alu	2081061 2 1	PB202-14	13..20	AF104-47	47..54	
85	YZ P.R.	02-15	428	118	stealth ■	4851061 2 1	PB202-14	13..20	CE104SB-47	44,47,54	
85	YZ G.R.	02-18	428	124	acier	1051060 2 1	PB202-14	13..20	CE104-52	44,47,54	
85	YZ G.R.	02-18	428	124	alu	2081060 2 1	PB202-14	13..20	AF104-52	47..54	
85	YZ G.R.	02-18	428	124	stealth ■	4851060 2 1	PB202-14	13..20	CE104SB-52	44,47,54	
85	YZ G.R.	19->	428	124	acier	1051062 2 1	PB202-14	13..20	CE104-51	44,47,54	
85	YZ G.R.	19->	428	124	alu	2081062 2 1	PB202-14	13..20	AF104-51	47..54	
85	YZ G.R.	19->	428	124	stealth ■	4851062 2 1	PB202-14	13..20	CE104SB-51	44,47,54	
90	TT-R	00-04	420	86	acier	1051090 2 1	PK100-14	12..16	CC101-35	28..32,35..39,41,43,45,48	
100	RT	90-00	420	104	acier	1051091 0 1	PK100-14	12..16	CC101-48	28..32,35..39,41,43,45,48	
110	TT-R 110 E	08-20	420	92	acier	1051116 2 1	PK100-14	12..16	CC101-36	28..32,35..39,41,43,45,48	
125	TTR P.R. SW	00-01	428	116	acier	1051194 1 1	PB207-13	13,14	CC102-49	41,43,49,54	
125	TTR G.R. LW	00-01	428	122	acier	1051099 1 1	PB207-13	13,14	CC102-54	41,43,49,54	
125	TTR P.R. 5HP6 / 5HPP SW	02-09	428	116	acier	1051113 1 1	PB207-13	13,14	CC224-49	49,54	
125	TTR G.R. 5HP9 / 5HPH/M LW	02-20	428	122	acier	1051132 1 1	PB207-13	13,14	CC224-54	49,54	
125	TY	76-89	428	120	acier	1051134 1 1	PI200-13	12..15	CC208-52	37,42,44,45,47,49..52,54,55	
125	WR	<-98	520	112	acier	1051106 5 1	PB203-13	12..14	CC500-48	40..42,44,47..50,52	
125	WR	<-98	520	112	alu	2081106 5 1	PB203-13	12..14	AD500-48	40..54	
125	WR	99-01	520	112	acier	1051107 5 1	PB203-13	12..14	CA304-48	38..53	
125	WR	99-01	520	112	alu	2081107 5 1	PB203-13	12..14	AD323-48	45..54	
125	WR	02-03	520	112	acier	1051108 5 1	PB203-13	12..14	CA304-49	38..53	
125	WR	02-03	520	112	alu	2081108 5 1	PB203-13	12..14	AD323-49	45..54	
125	YFA Breeze (3FA)	89->	520	74	acier	1051138 5 1	PK300-12	10..17	CC214-32	28,32	
125	YFM S Grizzly	04->	520	74	acier	1051138 5 1	PK300-12	10..17	CC214-32	28,32	
125	YZ	89-89	520	114	alu	2081100 2 1	PB203-13	12..14	AD500-51	40..54	
125	YZ	90-92	520	116	alu	2081101 2 1	PB203-13	12..14	AD500-51	40..54	
125	YZ	93-93	520	116	alu	2081102 2 1	PB203-13	12..14	AD500-50	40..54	
125	YZ	94-94	520	116	alu	2081103 2 1	PB203-13	12..14	AD500-51	40..54	
125	YZ	95-95	520	114	alu	2081104 2 1	PB203-13	12..14	AD500-50	40..54	
125	YZ	96-96	520	112	alu	2081105 2 1	PB203-13	12..14	AD500-50	40..54	
125	YZ	97-98	520	112	alu	2081106 2 1	PB203-13	12..14	AD500-48	40..54	
125	YZ	99-01	520	112	acier	1051107 2 1	PB203-13	12..14	CA304-48	38..53	
125	YZ	99-01	520	112	alu	2081107 2 1	PB203-13	12..14	AD323-48	45..54	
125	YZ	02-04	520	112	acier	1051108 2 1	PB203-13	12..14	CA304-49	38..53	
125	YZ	02-04	520	112	alu	2081108 2 1	PB203-13	12..14	AD323-49	45..54	
125	YZ	05-21	520	112	acier	1051109 2 1	PB309-13	12..15	CA304-48	38..53	
125	YZ	05-21	520	112	alu	2081109 2 1	PB309-13	12..15	AD323-48	45..54	
125	YZ	05-21	520	112	stealth ■	4851109 2 1	PB309-13	12..15	CA304SB-48	38..53	
125	YZ	05-21	520	112	stealth ■	4651109 2 1	PB309-13	12..15	CA304SG-48	38..53	
125	YZ	22->	520	112	acier	1051125 2 1	PB309-13	12..15	CA304-49	38..53	
125	YZ	22->	520	112	alu	2081125 2 1	PB309-13	12..15	AD323-49	45..54	
125	YZ	22->	520	112	stealth ■	4851125 2 1	PB309-13	12..15	CA304SB-49	38..53	
125	YZ	22->	520	112	stealth ■	4651125 2 1	PB309-13	12..15	CA304SG-49	38..53	
200	IT	84-86	520	106	acier	1051186 5 1	PK200-12	12,13	CC500-44	40..42,44,47..50,52	
200	WR	91-97	520	116	acier	1051158 5 1	PB203-13	12..14	CC500-52	40..42,44,47..50,52	
200	WR	91-97	520	116	alu	2081158 2 1	PB203-13	12..14	AD500-52	40..54	
200	YF S Blaster	88->	520	92	acier	1051170 5 1	PB300-13	13	CC500-40	40..42,44,47..50,52	
250	TTR	93-99	520	106	acier	1051181 5 1	PB307-14	13,14	CC500-44	40..42,44,47..50,52	



Cyl	Modèle	Année	CHAÎNE		KIT			PIGNON		COURONNE	
			Pas	Maillons	Matériau	RÉFÉRENCE Racine Qualité Attache	Référence	Nb dents dispos	Référence	Nb dents dispos	
250	TTR	93-99	520	106	alu	20811815 1	PB307-14	13,14	AD500-44	40..54	
250	TTR	00->	520	106	acier	10511815 1	PB307-14	13,14	CC500-44	40..42,44,47..50,52	
250	TTR	00->	520	106	alu	20811815 1	PB307-14	13,14	AD500-44	40..54	
250	WR	89-90	520	114	alu	20811335 1	PK300-14	10..17	AD500-49	40..54	
250	WR	91-96	520	116	acier	10511455 1	PK300-14	10..17	CC500-52	40..42,44,47..50,52	
250	WR	91-96	520	116	alu	20811455 1	PK300-14	10..17	AD500-52	40..54	
250	WR	97-97	520	114	acier	10511335 1	PK300-14	10..17	CC500-49	40..42,44,47..50,52	
250	WR	97-97	520	114	alu	20811335 1	PK300-14	10..17	AD500-49	40..54	
250	WR	98-99	520	114	acier	10511465 1	PK300-14	10..17	CC500-48	40..42,44,47..50,52	
250	WR	98-99	520	114	alu	20811465 1	PK300-14	10..17	AD500-48	40..54	
250	WR	00-01	520	114	acier	10511395 1	PH500-14	13..17	CA304-50	38..53	
250	WR	00-01	520	114	alu	20811395 1	PH500-14	13..17	AD323-50	45..54	
250	WR	02-03	520	114	acier	10511475 1	PH500-14	13..17	CA304-48	38..53	
250	WR	02-03	520	114	alu	20811475 1	PH500-14	13..17	AD323-48	45..54	
250	WR-F	01-04	520	114	acier	10511415 1	PB309-13	12..15	CA304-50	38..53	
250	WR-F	01-04	520	114	alu	20811415 1	PB309-13	12..15	AD323-50	45..54	
250	WR-F	05-06	520	116	alu	20811825 1	PB309-13	12..15	AD323-52	45..54	
250	WR-F	07-18	520	114	acier	10511415 1	PB309-13	12..15	CA304-50	38..53	
250	WR-F	07-18	520	114	alu	20811415 1	PB309-13	12..15	AD323-50	45..54	
250	WR-F	07-18	520	114	stealth ■	4B511415 1	PB309-13	12..15	CA3045B-50	38..53	
250	WR-F	07-18	520	114	stealth ■	4G511415 1	PB309-13	12..15	CA3045G-50	38..53	
250	WR-F	19->	520	114	acier	10511625 1	PB309-13	12..15	CA304-51	38..53	
250	WR-F	19->	520	114	alu	20811625 1	PB309-13	12..15	AD323-51	45..54	
250	WR-F	19->	520	114	stealth ■	4B511625 1	PB309-13	12..15	CA3045B-51	38..53	
250	WR-F	19->	520	114	stealth ■	4G511625 1	PB309-13	12..15	CA3045G-51	38..53	
250	YFM R	08->	520	102	acier	10512135 1	PB310-14	14	CC509-38	36...40,42,45,47	
250	YZ	87-89	520	114	alu	20811302 1	PK300-14	10..17	AD500-49	40..54	
250	YZ	90-93	520	116	alu	20811312 1	PK300-14	10..17	AD500-51	40..54	
250	YZ	94-94	520	114	alu	20811322 1	PK300-13	10..17	AD500-49	40..54	
250	YZ	95-95	520	114	alu	20811332 1	PK300-14	10..17	AD500-49	40..54	
250	YZ	96-96	520	114	alu	20811342 1	PK300-13	10..17	AD500-49	40..54	
250	YZ	97-97	520	114	alu	20811352 1	PK300-14	10..17	AD500-50	40..54	
250	YZ	98-98	520	116	alu	20811362 1	PK300-14	10..17	AD500-50	40..54	
250	YZ	99-01	520	114	acier	10511392 1	PH500-14	13..17	CA304-50	38..53	
250	YZ	99-01	520	114	alu	20811392 1	PH500-14	13..17	AD323-50	45..54	
250	YZ	02-04	520	114	acier	10511472 1	PH500-14	13..17	CA304-48	38..53	
250	YZ	02-04	520	114	alu	20811472 1	PH500-14	13..17	AD323-48	45..54	
250	YZ	05-22	520	114	acier	10511392 1	PH500-14	13..17	CA304-50	38..53	
250	YZ	05-22	520	114	alu	20811392 1	PH500-14	13..17	AD323-50	45..54	
250	YZ	05-22	520	114	stealth ■	4B511392 1	PH500-14	13..17	CA3045B-50	38..53	
250	YZ	05-22	520	114	stealth ■	4G511392 1	PH500-14	13..17	CA3045G-50	38..53	
250	YZ-F	01-04	520	114	acier	10511482 1	PB309-13	12..15	CA304-48	38..53	
250	YZ-F	01-04	520	114	alu	20811482 1	PB309-13	12..15	AD323-48	45..54	
250	YZ-F	05-09	520	114	acier	10511612 1	PB309-13	12..15	CA304-49	38..53	
250	YZ-F	05-09	520	114	alu	20811612 1	PB309-13	12..15	AD323-49	45..54	
250	YZ-F	10-13	520	114	acier	10511622 1	PB309-13	12..15	CA304-51	38..53	
250	YZ-F	10-13	520	114	alu	20811622 1	PB309-13	12..15	AD323-51	45..54	
250	YZ-F	10-13	520	114	stealth ■	4B511622 1	PB309-13	12..15	CA3045B-51	38..53	
250	YZ-F	10-13	520	114	stealth ■	4G511622 1	PB309-13	12..15	CA3045G-51	38..53	
250	YZ-F	14-22	520	114	acier	10511642 1	PB309-13	12..15	CA304-50	38..53	
250	YZ-F	14-22	520	114	alu	20811642 1	PB309-13	12..15	AD323-50	45..54	
250	YZ-F	14-22	520	114	stealth ■	4B511642 1	PB309-13	12..15	CA3045B-50	38..53	
250	YZ-F	14-22	520	114	stealth ■	4G511642 1	PB309-13	12..15	CA3045G-50	38..53	
350	TT (3GJ)	86-97	520	108	acier	10511492 1	PB502-14	14..16	CC500-50	40..42,44,47..50,52	
350	TT (3GJ)	86-97	520	108	alu	20811492 1	PB502-14	14..16	AD500-50	40..54	
350	YFM S Raptor	04->	520	98	acier	10512115 1	PK300-13	10..17	CC505-38	38..41,43,45..48	
350	YFM Warrior 4 vis	87-88	520	100	acier	10512065 1	PK300-13	10..17	CC505-40	38..41,43,45..48	
350	YFM Warrior 6 vis	89->	520	98	acier	10512075 1	PK300-13	10..17	CC500-40	40..42,44,47..50,52	
350	YFZ Banshee	89-05	520	104	acier	10512085 1	PK300-14	10..17	CC500-41	40..42,44,47..50,52	
400	WR	98-98	520	114	acier	10511605 1	PH500-14	13..17	CC500-50	40..42,44,47..50,52	

TRANSMISSION

Cyl	Modèle	Année	CHAÎNE		Matériau	KIT			PIGNON		COURONNE	
			Pas	Maillons		Racine	RÉFÉRENCE Qualité	Attache	Référence	Nb dents dispos	Référence	Nb dents dispos
YAMAHA												
400	WR	98-98	520	114	alu	2081160	5	1	PH500-14	13..17	AD500-50	40..54
400	WR	99-00	520	114	acier	1051139	5	1	PH500-14	13..17	CA304-50	38..53
400	WR	99-00	520	114	alu	2081139	5	1	PH500-14	13..17	AD323-50	45..54
400	YZ F	98-98	520	114	alu	2081150	2	1	PH500-14	13..17	AD500-49	40..54
400	YZ F	99-99	520	114	alu	2081151	2	1	PH500-14	13..17	AD323-49	45..54
426	WR	00-02	520	114	acier	1051139	5	1	PH500-14	13..17	CA304-50	38..53
426	WR	00-02	520	114	alu	2081139	5	1	PH500-14	13..17	AD323-50	45..54
426	YZ-F	00-02	520	112	acier	1051154	2	1	PH500-14	13..17	CA304-48	38..53
426	YZ-F	00-02	520	112	alu	2081154	2	1	PH500-14	13..17	AD323-48	45..54
450	WR F	03-06	520	114	acier	1051177	5	1	PH500-14	13..17	CA304-50	38..53
450	WR F	03-06	520	114	alu	2081177	5	1	PH500-14	13..17	AD323-50	45..54
450	WR F	07-22	520	114	acier	1051178	5	1	PH500-13	13..17	CA304-50	38..53
450	WR F	07-22	520	114	alu	2081178	5	1	PH500-13	13..17	AD323-50	45..54
450	WR F	07-22	520	114	stealth	4B51178	5	1	PH500-13	13..17	CA304SB-50	38..53
450	WR F	07-22	520	114	stealth	4G51178	5	1	PH500-13	13..17	CA304SG-50	38..53
450	YZ / S Quad	04-08	520	98	acier	1051175	5	2	PH500-14	13..17	CC509-38	36...40,42,45,47
450	YZ R Quad	09->	520	98	acier	1051174	5	2	PB608-14	13..15	CC509-38	36...40,42,45,47
450	YZ-F	03-04	520	112	acier	1051190	2	1	PH500-14	13..17	CA304-47	38..53
450	YZ-F	03-04	520	112	alu	2081190	2	1	PH500-14	13..17	AD323-47	45..54
450	YZ-F	05-06	520	114	acier	1051191	2	1	PH500-14	13..17	CA304-51	38..53
450	YZ-F	05-06	520	114	alu	2081191	2	1	PH500-14	13..17	AD323-51	45..54
450	YZ-F	07-17	520	114	acier	1051192	2	1	PH500-13	13..17	CA304-49	38..53
450	YZ-F	07-17	520	114	alu	2081192	2	1	PH500-13	13..17	AD323-49	45..54
450	YZ-F	07-17	520	114	stealth	4B51192	2	1	PH500-13	13..17	CA304SB-49	38..53
450	YZ-F	07-17	520	114	stealth	4G51192	2	1	PH500-13	13..17	CA304SG-49	38..53
450	YZ-F	18-19	520	114	acier	1051196	2	1	PH500-13	13..17	CA304-48	38..53
450	YZ-F	18-19	520	114	alu	2081196	2	1	PH500-13	13..17	AD323-48	45..54
450	YZ-F	18-19	520	114	stealth	4B51196	2	1	PH500-13	13..17	CA304SB-48	38..53
450	YZ-F	18-19	520	114	stealth	4G51196	2	1	PH500-13	13..17	CA304SG-48	38..53
450	YZ-F	20->	520	114	acier	1051192	2	1	PH500-13	13..17	CA304-49	38..53
450	YZ-F	20->	520	114	alu	2081192	2	1	PH500-13	13..17	AD323-49	45..54
450	YZ-F	20->	520	114	stealth	4B51192	2	1	PH500-13	13..17	CA304SB-49	38..53
450	YZ-F	20->	520	114	stealth	4G51192	2	1	PH500-13	13..17	CA304SG-49	38..53
600	TT	83-92	520	114	acier	1051356	5	1	PB502-14	14..16	CC500-50	40..42,44,47..50,52
600	TT P, R, S	93-95	520	112	acier	1051357	5	1	PB504-15	14..16	CC500-44	40..42,44,47..50,52
600	TT R	97-03	520	112	acier	1051357	5	1	PB504-15	14..16	CC500-44	40..42,44,47..50,52
660	YFM Raptor	01-06	520	92	acier	1051490	5	2	PH500-13	13..17	CC500-40	40..42,44,47..50,52
700	YFM Raptor	06->	520	98	acier	1051491	5	2	PB608-14	13..15	CC509-38	36...40,42,45,47



COURONNES & PIGNONS

Supersprox

Couronne acier

*Le haut de gamme selon
SUPERSPROX.*

Vous pensiez que tout avait été dit sur la couronne acier ? Alors regardez une couronne acier SUPERSPROX et jugez plutôt : la regarder, c'est être convaincu !

Conception par ordinateur pour une découpe laser, traitement thermique, finition anti-corrosion de haute performance.



Pignon

Acier traité haute résistance « SCM45 ». Pignon ajouré pour plus de légèreté et denture auto nettoyante

Emballage blister ouvrable avec étiquette informative sur application dédiée



Couronne bi-métal

STEALTH, l'original, l'unique.

Protégée par brevet, plus légère de 10 à 50% par rapport à une couronne acier classique (selon le modèle) d'une durée de vie trois fois supérieure à une couronne aluminium standard, la couronne SUPERSPROX STEALTH est conçue pour les conditions de roulage extrêmes où les couronnes aluminium classiques ne sont pas à même d'absorber les puissants couples moteurs.



Couronne aluminium

Vous recherchez avant tout la légèreté ? La couronne aluminium SUPERSPROX répondra à vos attentes. Utilisant de l'aluminium 7075 T6 réputé pour sa résistance et sa légèreté. Conçue spécifiquement pour la course.



EDGE

Prolongez votre voyage

SUPERSPROX EDGE est une couronne acier alésée afin de pouvoir insérer un disque aluminium de couleur vive. La couronne est ainsi 30% plus légère qu'une couronne acier OEM, beaucoup plus résistante et le design en plus.

Couronnes Aluminium

Explication de la référence couronne

Couleur standard NOIR

Option de couleur

AB212X | **48**
 Réf. couronne | Nb de dents

AB212X | **R** | **48**
 Réf. couronne | | Nb de dents

B : BLEU

G : OR

O : ORANGE

R : ROUGE

Référence	€ T.T.C.
HONDA CR 85 <420>	
AB104X49	48,90
AB104X50	48,90
AB104X55	48,90
AB104X56	48,90
HONDA CR 85 <428>	
AB111X49	48,90
HONDA CR 125, 250 / CR-F R 250, 450(1983/2022)	
AB212X40	52,90
AB212X42	52,90
AB212X44	52,90
AB212X45	52,90
AB212X46	52,90
AB212X47	52,90
AB212X48	52,90
AB212X49	52,90
AB212X50	52,90
AB212X51	52,90
AB212X52	52,90
AB212X53	52,90
AB212XR48	52,90
AB212XR49	52,90
AB212XR50	52,90
AB212XR51	52,90
AB212XR52	52,90
AB212XR53	52,90
KAWASAKI KX 65	
AH107X47	48,90
KAWASAKI KX 80/85 <420>	
AH104X50	48,90
AH104X51	48,90
AH104X54	48,90
KAWASAKI KX 80/85 <428>	
AH105X49	48,90
AH105X51	48,90
AH105X52	48,90
AH105X53	48,90
AH105X54	48,90
KAWASAKI KX 125-250, KX-F 250-450 (1985/2022)	
AH206X42	52,90
AH206X47	52,90
AH206X48	52,90
AH206X49	52,90
AH206X50	52,90
AH206X51	52,90
AH206X52	52,90

Référence	€ T.T.C.
SUZUKI RM 65	
AH107X47	48,90
SUZUKI RM, RM-X, RM-Z 125, 250, 450 (1983/2022)	
AF203X41	52,90
AF203X44	52,90
AF203X47	52,90
AF203X48	52,90
AF203X49	52,90
AF203X50	52,90
AF203X51	52,90
AF203XG47	52,90
AF203XG48	52,90
AF203XG49	52,90
AF203XG50	52,90
AF203XG51	52,90
YAMAHA YZ 80/85 <428>	
AF104X44	48,90
AF104X47	48,90
AF104X48	48,90
AF104X50	48,90
AF104X51	48,90
AF104X52	48,90
AF104X53	48,90
YAMAHA WR 125, 250, WR-F400, 426 / YZ125, 250, YZ-F 400, 426 (1985/1998)	
AD500X47	52,90
AD500X48	52,90
AD500X49	52,90
AD500X50	52,90
AD500X51	52,90
AD500X52	52,90
YAMAHA WR, WR-F 250, 450 / YZ125, 250 / YZ-F250, 450 (1999/2022)	
AD323X46	52,90
AD323X47	52,90
AD323X48	52,90
AD323X49	52,90
AD323X50	52,90
AD323X51	52,90
AD323X52	52,90
AD323XB47	52,90
AD323XB48	52,90
AD323XB49	52,90
AD323XB50	52,90
AD323XB51	52,90
AD323XB52	52,90
AD323XB54	52,90



Référence	€ T.T.C.
AD323XR47	52,90
AD323XR48	52,90
AD323XR49	52,90
AD323XR50	52,90
AD323XR51	52,90
AD323XR52	52,90
BETA RR 125, 250, 300, 350, 400, 450 (2005/2012)	
GASGAS EC 125, 250, 300 (2000-2018)	
HUSQVARNA 1990/2012 CR, TC, TE, WR 125, 250, 310, 350, 410, 510, 570, 610	
SHERCO SE-R, SEF-R 125, 250, 300, 450, 510	
AF206X47	52,90
AF206X48	52,90
AF206X49	52,90
AF206X50	52,90
AF206X51	52,90
AF206X52	52,90
AF206XB48	52,90
AF206XB49	52,90
AF206XB50	52,90
AF206XB51	52,90
AF206XN48	52,90
AF206XR48	52,90
AF206XR49	52,90
AF206XR50	52,90
AF206XR51	52,90
AF206XR52	52,90
BETA RR 250, 300, 350, 400, 450, 480, 498 (2013-)	
AU340XR47	52,90
AU340XR48	52,90
AU340XR49	52,90
AU340XR50	52,90
KTM SX 50 (2002-)	
AU108X44	48,90
KTM SX 50 (2013-)	
AP103X40	48,90
KTM SX 65, HVA TC 65 (2001-)	
AP101X46	48,90
AP101X48	48,90
AP101X50	48,90
AP101XO46	48,90
AP101XO48	48,90
AP101XO50	48,90
KTM SX 85, HVA TC 85 (2003-)	
AP102X46	48,90
AP102X48	48,90
AP102X49	48,90
AP102XO46	48,90
AP102XO49	48,90
KTM EXC, EXC-F, SX, SX-F 125, 250, 300, 350, 400, 450, 500 (1991/2022)	
GAS GAS EC, MC 125, 250, 350, 450 (2021-2022)	
HUSQVARNA FC, FE, TC, TE 125, 250, 300, 350, 400, 450, 500 (2014/2022)	
HUSABERG FC, FE, TC, TE 125, 250, 300, 350, 400, 450, 501, 550, 570 (2000/2013)	
AP304X40	52,90
AP304X42	52,90
AP304X45	52,90
AP304X48	52,90
AP304X49	52,90
AP304X50	52,90
AP304X51	52,90

Référence	€ T.T.C.
AP304X52	52,90
AP304X53	52,90
AP304X54	52,90
AP304XB48	52,90
AP304XB49	52,90
AP304XB50	52,90
AP304XB51	52,90
AP304XB52	52,90
AP304XO48	52,90
AP304XO50	52,90
AP304XO51	52,90
AP304XO52	52,90
KTM FREERIDE 250, 350	
AP307X46	52,90
AP307X48	52,90
TM 125, 250, 400, 450	
AU314X51	52,90
AU314X52	52,90
AU314XG51	52,90

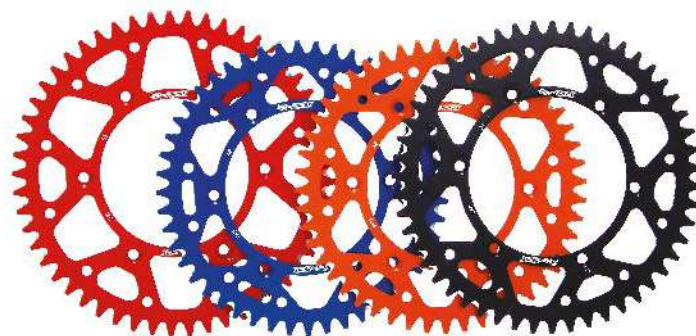

Couronnes STEALTH

Supersprox

Explication de la référence couronne

CO304S

Réf. couronne

O
48

Nb de dents

O : ORANGE
N : NOIR
G : OR
R : ROUGE
S : SILVER
B : BLEU

Références	€ T.T.C.
HONDA CR 85 <420>	
CA104SN49	57,90
CA104SN50	57,90
CA104SN55	57,90
CA104SR49	57,90
CA104SR50	57,90
CA104SR55	57,90
HONDA CR 125, 250 /CR-F R 250, 450 (1983/2022)	
CA212SN48	69,90
CA212SN49	69,90
CA212SN50	69,90
CA212SR45	69,90
CA212SR47	69,90
CA212SR48	69,90
CA212SR49	69,90
CA212SR50	69,90
CA212SR51	69,90
CA212SR52	69,90
CA212SR53	69,90
KAWASAKI KX 60 (83/03), KX80 (83/85)	
CG100SN50	57,90
KAWASAKI KX 65	
CG107SN47	57,90
KAWASAKI KX 80/85 <420>	
CG104SN44	57,90
CG104SN50	57,90
CG104SN51	57,90
KAWASAKI KX 125-250, KX-F 250-450 (1985/2022)	
CG204SG47	69,90
CG204SG48	69,90
CG204SG49	69,90
CG204SG50	69,90
CG204SG51	69,90
CG204SN49	69,90
CG204SN50	69,90
SUZUKI RM 65	
CG107SN47	57,90
SUZUKI RM, RM-X, RM-Z 125, 250, 450 (1983/2022)	
CE203SG41	69,90
CE203SG44	69,90
CE203SG45	69,90
CE203SG46	69,90
CE203SG47	69,90
CE203SG48	69,90
CE203SG49	69,90
CE203SG50	69,90
CE203SG51	69,90

Références	€ T.T.C.
CE203SN41	69,90
CE203SN44	69,90
CE203SN47	69,90
CE203SN49	69,90
CE203SN50	69,90
CE203SN51	69,90
YAMAHA YZ 80/85 <428>	
CE104SB47	57,90
CE104SB51	57,90
CE104SB52	57,90
CE104SN44	57,90
CE104SN47	57,90
CE104SN48	57,90
CE104SN50	57,90
CE104SN52	57,90
YAMAHA WR 125, 250, WR-F400, 426 / YZ125, 250, YZ-F 400, 426 (1985/1998)	
CC500SB48	57,90
CC500SB49	57,90
CC500SN48	57,90
CC500SN49	57,90
YAMAHA WR, WR-F 250, 450 / YZ125, 250 / YZ-F250, 450 (1999/2022)	
CA304SB48	69,90
CA304SB49	69,90
CA304SB50	69,90
CA304SB51	69,90
CA304SB52	69,90
CA304SG46	69,90
CA304SG47	69,90
CA304SG48	69,90
CA304SG49	69,90
CA304SG50	69,90
CA304SG51	69,90
CA304SG52	69,90
CA304SN48	69,90
CA304SN49	69,90
CA304SN51	69,90
CA304SR48	69,90
CA304SR49	69,90
CA304SR50	69,90
CA304SR51	69,90
CA304SR52	69,90





Références € T.T.C.

BETA RR 125, 250, 300, 350 ,400 ,450 (2005/2012)
GASGAS EC 125, 250 ,300 (2000-2018)
HUSQVARNA 1990/2012 CR, TC, TE, WR 125, 250, 310, 350, 410, 510, 570, 610
SHERCO SE-R, SEF-R 125, 250, 300, 450, 510

CE206SB48	■	69,90
CE206SB49	■	69,90
CE206SB50	■	69,90
CE206SB51	■	69,90
CE206SG47	■	69,90
CE206SG48	■	69,90
CE206SG49	■	69,90
CE206SG50	■	69,90
CE206SG51	■	69,90
CE206SN48	■	69,90
CE206SN49	■	69,90
CE206SN50	■	69,90
CE206SR46	■	69,90
CE206SR48	■	69,90
CE206SR49	■	69,90
CE206SR50	■	69,90
CE206SR51	■	69,90
CE206SR52	■	69,90

BETA RR 250, 300, 350, 400 ,450, 480, 498 (2013-)

CX340SR48	■	69,90
CX340SR50	■	69,90
CX340SS47	■	69,90
CX340SS48	■	69,90
CX340SS50	■	69,90
CX340SS51	■	69,90

KTM SX 50 (1997)

CX107SG48	■	57,90
CX107SN48	■	57,90

KTM SX 50 (2002-)

CX108SG48	■	57,90
CX108SN48	■	57,90

KTM SX 65, HVA TC 65 (2001-)

CO101SG46	■	57,90
CO101SG48	■	57,90
CO101SG50	■	57,90
CO101SN46	■	57,90
CO101SN48	■	57,90
CO101SN50	■	57,90

KTM SX 85, HVA TC 85 (2003-)

CO200SG46	■	57,90
CO200SG49	■	57,90
CO200SN46	■	57,90
CO200SN49	■	57,90

KTM EXC, EXC-F, SX, SX-F 125, 250, 300, 350, 400, 450, 500 (1991/2020)

GAS GAS EC, MC 125, 250, 350, 450 (2021-2022)
HUSQVARNA FC, FE, TC, TE 125, 250, 300, 350, 400, 450, 500 (2014/2020)
HUSABERG FC, FE, TC, TE 125, 250, 300, 350, 400, 450, 501, 550, 570 (2000/2013)

CO304SB48	■	69,90
CO304SB49	■	69,90
CO304SB50	■	69,90
CO304SB51	■	69,90
CO304SB52	■	69,90
CO304SG40	■	69,90
CO304SG42	■	69,90
CO304SG45	■	69,90
CO304SG46	■	69,90
CO304SG48	■	69,90

Références € T.T.C.

CO304SG49	■	69,90
CO304SG50	■	69,90
CO304SG51	■	69,90
CO304SG52	■	69,90
CO304SN48	■	69,90
CO304SN50	■	69,90
CO304SN51	■	69,90
CO304SN52	■	69,90
CO304SO48	■	69,90
CO304SO49	■	69,90
CO304SO50	■	69,90
CO304SO51	■	69,90
CO304SO52	■	69,90
CO304SR48	■	69,90
CO304SR49	■	69,90
CO304SR50	■	69,90
CO304SR51	■	69,90
CO304SR52	■	69,90
CO304SS48	■	69,90
CO304SS50	■	69,90

POLARIS QUAD TRAIL BOSS, SCRAMBLER 250, 300 ,330, 400, 450, 500

CX404SN34	■	69,90
CX404SN36	■	69,90
CX404SN37	■	69,90
CX404SN38	■	69,90
CX404SN40	■	69,90
CX404SN42	■	69,90

SUZUKI QUAD LT-Z 400 (2003/2008)

CE310SN39	■	69,90
CE310SN40	■	69,90
CE310SN42	■	69,90

SUZUKI QUAD LT-R 450, LT-Z 400 (2009-)

CE409SN36	■	69,90
CE409SN40	■	69,90

TM EN, MX 125, 250, 300, 400, 450 (2000-)

CX314SB49	■	69,90
CX314SB50	■	69,90
CX314SB51	■	69,90
CX314SB52	■	69,90



CHAÎNES



Les chaînes D.I.D

D.I.D®

D.I.D possède la plus longue expérience qui soit dans l'équipement d'origine.

La chaîne D.I.D X-Ring

Leader en matière de chaîne haute performance, pour une friction minimum et une longévité supérieure. Moitié moins de perte de puissance qu'avec une chaîne O-Ring normale.

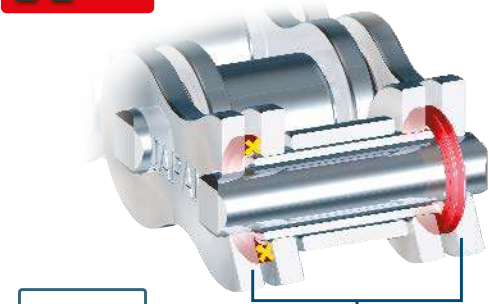
X RING

L'action de torsion du X-Ring disperse la pression et minimise la perte de puissance.

Perte de puissance diminuée de moitié



La construction du joint X-Ring® DiD breveté, réduit les frictions en se tordant entre les plaques latérales au lieu d'être écrasé.

Performance des chaînes X-Ring®

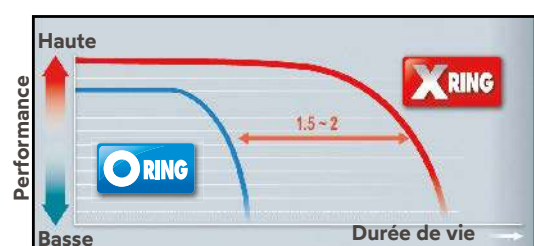

Les quatre points de contact du X-Ring confèrent une étanchéité parfaite. Cela empêche la saleté de pénétrer et la lubrification est assurée.

Série

VX**X RING**

NOUVEAUTÉ



Silver (S&S)

Plus de résistance à l'usure

Exclusives et brevetées, les chaînes X-Ring D.I.D ont une résistance à l'usure de 40% supérieure à une chaîne O-Ring. La série VX est plus rigide pour une torsion faible.

Moins de perte de puissance

Les joints X-Ring D.I.D diminuent la friction entre les plaques et réduisent la perte de puissance de 50% comparé à tous types de chaînes O Ring concurrents.

La série VX se décline en noir (B&B), or et noir (G&B) et désormais avec une nouvelle finition silver (S&S)



Noir (B&B)



Or et noir (G&B)

Série **ER**

Spéciale tout terrain

Chaîne à joints X-ring révolutionnaire pour les courses de motocross et d'enduro ! La nouvelle ERVT met fin au concept : "chaîne cross = chaîne sans joints". Plus légère et plus résistante, durable et résistante : le choix des top teams !

**520ERV7****X RING**

Liste des chaînes DID

Chaîne	Disp. CC	Joint	Utilisation
415ERZ G&G	50 cc	-	Racing
420NZ3 G&B	50-125cc	-	Mini cross
428NZ G&B	50-125cc	-	Mini cross
428VX	50-350cc	X RING	Meilleur rapport qualité/prix
520NZ B&B	max 450 cc	-	Entrée de gamme
520DZ2 G&B	max 450 cc	-	Entrée de gamme
520ERT3 G&G	125-450cc	-	Cross / Supercross / Supermotard
520VX3	125-800cc	X RING	Meilleur rapport qualité/prix
520ERV7	250-500cc	X RING	Chaîne étroite Enduro / Racing
520MX G&B	250-500cc	-	Racing
520ERS3 G&G	125-300cc	-	Sans joint pour Trial
520ATV2 G&B	max 750 cc	X RING	Basse friction / Quad Racing
520ERV7 G&G	250-1000cc	X RING	Racing
520ZVM-X	250-1200cc	X RING	Solidité maximum Durée de vie optimale



Spécifications chaînes

Séries	Joint	Chaîne	Couleurs	SDH	Long. axe (mm)	Ø rouleau (mm)	Épaisseur plaque int.	Épaisseur plaque ext.	Poids 100 maillons (kg)	Résistance à la traction (KN)	Indice de résistance à l'usure Chaîne std = 100	Type d'attache	
												Rivet ZJ	Clip FJ/RJ
ER		415ERZ	G&G	•	13,50	7,77	1,5	1,5	0,66	20,2	410	o	RJ
		520ERS2	G&G	-	16,75	10,16	1,8	1,8	1,15	25,9	360	o	RJ
		520ERT3	G&G	•	17,60	10,16	2,0	2,0	1,36	36,0	430	o	RJ
		520MX	G&B	•	18,60	10,16	2,2	2,2	1,56	39,7	440	•	-
		520ERV7	G&G	-	18,85	10,30	2,0	2,0	1,55	40	3500	•	-
		520ERTV	G&G	-	18,70	10,16	1,8	2,0	1,46	37,5	3500	o	FJ
ZVM-X		520ZVM-X	G&G Glossy Black	-	21,00	10,22	2,2	2,2	1,63	38,9	3500	•	-
VX		428VX	B&B	-	20,65	8,60	2,0	2,0	1,21	33,0	2700	o	FJ
		520VX3	B&B/G&B/S&S	-	18,70	10,22	2,0	2,0	1,52	36,5	3500	•	o / FJ
V		420V	B&B	-	16,90	7,77	1,5	1,5	0,73	15,8	700	-	RJ
SPECIAL		520ATV	G&B	-	21,00	10,22	2,2	2,2	1,66	33,9	3250	o	FJ
		520DZ2	G&B	•	17,65	10,16	2,0	2,0	1,40	36,0	410	o	RJ
NZ		420NZ3	G&B	•	16,75	7,77	1,8	1,8	0,82	21,9	410	-	RJ
		428NZ	G&B	•	18,90	8,50	2,0	2,0	1,00	25,5	410	o	FJ
		520NZ	B&B	•	18,35	10,20	2,2	2,2	1,61	35,8	410	o	FJ

■ sans joint ■ Xring ■ Oring • = oui - = non o = option

Référence chaîne MORACO

Exemple : 520 ERVT G&G x 118 FJ



0	10	415ER
1	00	420D
1	02	420NZ3 G&B
1	05	420V
2	00	428D
2	01	428HD
2	02	428NZ G&B
2	05	428VX
3	00	520
3	01	520NZ
3	02	520ERT3 G&G

3	05	520VX2
3	06	520VX2 G&B
3	07	520VX3 S&S
3	09	520 ZVM-X G&G
3	10	520ERV7 G&G
3	11	520ERS2 G&G
3	13	520MX G&B
3	14	520ATV G&B
3	21	520DZ2 G&B
3	24	520ERTV G&G

Attaches

Désignation	Référence	€ H.T.	€ T.T.C.
Attaches rapides, montage à la pince			
428NZ(GB) FJ	532029991	1,58 €	1,90 €
428VX FJ	532059991	3,46 €	4,16 €
520NZ FJ	533019991	1,88 €	2,26 €
520VX3 FJ	533059991	4,23 €	5,08 €
520VX3(G&B) FJ	533069991	4,61 €	5,53 €
520VX3(S&S) FJ	533079991	3,21 €	3,86 €
520ERTV(G&G) FJ	533249991	3,77 €	4,53 €
520ATV2(G&B) FJ	533149991	4,97 €	5,97 €
Attaches rapides, montage libre			
415S RJ	530009991	0,90 €	1,07 €
415ERZ(GG) RJ	530109991	1,89 €	2,27 €
420D RJ	531009991	0,96 €	1,15 €
420NZ3(GB) RJ	531029991	1,49 €	1,78 €
420V RJ	531059991	2,66 €	3,20 €
428D RJ	532009991	1,12 €	1,34 €
428HD RJ	532019991	1,14 €	1,37 €
520 RJ	533009991	1,65 €	1,98 €
520ERT3(GG) RJ	533029991	2,59 €	3,10 €
520ERS3(GG) RJ	533119991	2,42 €	2,90 €
520DZ2(GB) RJ	533219991	2,06 €	2,47 €

Désignation	Référence	€ H.T.	€ T.T.C.
Attaches à rivet			
415ERZ(GG) ZJ	530109992	1,89 €	2,27 €
420V ZJ	531059992	2,66 €	3,20 €
428NZ(GB) ZJ	532029992	1,58 €	1,90 €
428VX ZJ	532059992	3,46 €	4,16 €
520NZ ZJ	533019992	1,88 €	2,26 €
520ERT3(GG) ZJ	533029992	2,59 €	3,10 €
520VX3 ZJ	533059992	4,23 €	5,08 €
520VX3(G&B) ZJ	533069992	4,61 €	5,53 €
520VX3(S&S) ZJ	533079992	3,21 €	3,86 €
520ERTV(G&G) ZJ	533249992	3,77 €	4,53 €
520ATV2(G&B) ZJ	533149992	4,97 €	5,97 €
520ERS3(GG) ZJ	533119992	2,42 €	2,90 €
520DZ2(GB) ZJ	533219992	2,06 €	2,47 €
520ERV7(GG) ZJ	533109992	7,27 €	8,72 €
520ZVM-X(G&G) ZJ	533099992	5,94 €	7,12 €

Dérive et rive chaîne

Le KM500, un outil compact et facile à utiliser. Conçu pour river les maillons des chaînes D.I.D ZJ.

Désignation	Référence	€ H.T.	€ T.T.C.
KIT KM500 en 420/428	539400	89,12 €	106,94 €
OUTIL D.I.D KM500R (520-525-530)	539500	193,30 €	231,90 €
Poinçon pour outil D.I.D	539600	21,15 €	25,40 €



Tarifs chaînes

415		Longueur chaîne (nombre de maillons) / € T.T.C.																	
Chaîne	Qualité	1*	96	100	104	108	110	112	114	116	118	120	124	128	130	132	134	136	140
415ERZ racing	ERZ	0,71€	81,76	85,16	88,57	91,98	93,68	95,38	97,09	98,79	100,49	102,20	105,60	109,01	110,71	112,42	114,12	115,82	119,23

420		Longueur chaîne (nombre de maillons) / € T.T.C.																	
Chaîne	Qualité	1*	96	100	104	108	110	112	114	116	118	120	124	128	130	132	134	136	140
420D standard	0	0,16€	18,41	19,18	19,94	20,71	21,09	21,48	21,86	22,24	22,63	23,01	23,78	24,55	24,93	25,31	25,70	26,08	26,85
420NZ3	2	0,35€	39,85	41,51	43,17	44,83	45,66	46,49	47,32	48,15	48,98	49,81	51,47	53,13	53,96	54,79	55,62	56,45	58,11
420V	5	0,58€	67,20	70,00	72,80	75,60	77,00	78,40	79,80	81,20	82,60	84,00	86,80	89,59	90,99	92,39	93,79	95,19	97,99

428		Longueur chaîne (nombre de maillons) / € T.T.C.																	
Chaîne	Qualité	1*	96	100	104	108	110	112	114	116	118	120	124	128	130	132	134	136	140
428D standard	0	0,19€	22,16	23,09	24,01	24,94	25,40	25,86	26,32	26,78	27,24	27,71	28,63	29,55	30,01	30,48	30,94	31,40	32,32
428HD renforcée	1	0,26€	30,04	31,30	32,55	33,80	34,43	35,05	35,68	36,30	36,93	37,56	38,81	40,06	40,68	41,31	41,94	42,56	43,81
428NZ	2	0,46€	52,58	54,77	56,96	59,15	60,24	61,34	62,44	63,53	64,63	65,72	67,91	70,10	71,20	72,29	73,39	74,48	76,68
428VX	5	0,71€	81,49	84,89	88,28	91,68	93,38	95,07	96,77	98,47	100,17	101,87	105,26	108,66	110,35	112,05	113,75	115,45	118,84

520		Longueur chaîne (nombre de maillons) / € T.T.C.																	
Chaîne	Qualité	1*	96	100	104	108	110	112	114	116	118	120	124	128	130	132	134	136	140
520 standard	0	0,34€	39,09	40,72	42,34	43,97	44,79	45,60	46,42	47,23	48,04	48,86	50,49	52,12	52,93	53,75	54,56	55,37	57,00
520NZ renforcée	1	0,59€	67,58	70,39	73,21	76,02	77,43	78,84	80,25	81,65	83,06	84,47	87,29	90,10	91,51	92,92	94,33	95,73	98,55
520DZ2 racing	DZ2	0,61€	70,34	73,27	76,20	79,13	80,60	82,06	83,53	85,00	86,46	87,93	90,86	93,79	95,25	96,72	98,18	99,65	102,58
520ERT3	2	0,67€	77,17	80,39	83,60	86,82	88,43	90,03	91,64	93,25	94,86	96,47	99,68	102,90	104,50	106,11	107,72	109,33	112,54
520VX3	5	0,76€	87,33	90,97	94,61	98,25	100,07	101,89	103,71	105,53	107,35	109,17	112,81	116,44	118,26	120,08	121,90	123,72	127,36
520VX3	6	0,79€	90,87	94,66	98,44	102,23	104,12	106,01	107,91	109,80	111,69	113,59	117,37	121,16	123,05	124,95	126,84	128,73	132,52
520VX3	7	0,79€	90,87	94,66	98,44	102,23	104,12	106,01	107,91	109,80	111,69	113,59	117,37	121,16	123,05	124,95	126,84	128,73	132,52
520MX racing	MX	0,99€	114,54	119,32	124,09	128,86	131,25	133,63	136,02	138,41	140,79	143,18	147,95	152,72	155,11	157,50	159,88	162,27	167,04
520ERS3 racing	ERS3	1,10€	126,82	132,11	137,39	142,68	145,32	147,96	150,60	153,25	155,89	158,53	163,81	169,10	171,74	174,38	177,02	179,67	184,95
520ERTV	ERTV	0,98€	112,95	117,66	122,37	127,07	129,43	131,78	134,13	136,49	138,84	141,19	145,90	150,60	152,96	155,31	157,66	160,02	164,72
520ZVM-X	9	1,33€	152,67	159,04	165,40	171,76	174,94	178,12	181,30	184,48	187,66	190,84	197,20	203,57	206,75	209,93	213,11	216,29	222,65
520ERV7	ERV7	1,66€	191,61	199,60	207,58	215,56	219,56	223,55	227,54	231,53	235,52	239,52	247,50	255,48	259,47	263,47	267,46	271,45	279,43
520ATV racing	ATV	0,95€	109,70	114,28	118,85	123,42	125,70	127,99	130,27	132,56	134,85	137,13	141,70	146,27	148,56	150,84	153,13	155,42	159,99

428VX Noir / Noir

520VX3 Silver / Silver

520DZ2 Or / Noir

520ERT3 Or / Or

* Prix au maillon arrondi.



COURONNES & PIGNONS



NOUVEAUTÉ

Couronne HDK

Couronne Acier à haute durabilité

Conçue pour tous types de terrains,
indépendamment des conditions
météorologiques



Durable

C45 acier au carbone normalisé, pour assurer la meilleure dureté possible. Durcissement par induction des dents.

ALU 7075T6	ACIER C45N	ACIER TREMPÉ C45N
11 HRC	19 HRC	48 HRC

Économique

Cette couronne trempée pour l'off-road est proposée à un prix attractif.

Dents avec forme U

endurcie par induction.

Conception légère

Léger mais solide pour résister aux chocs latéraux.

Usinage CNC afin de respecter toutes les dimensions, tolérances géométriques et éviter la déformation mécanique de l'acier. Nous nous appuyons uniquement sur des machines à commandes numériques de haute précision.

Finition électrophorèse noire

Meilleure protection contre la rouille. Marquage des informations imprimé en blanc.



Applications couronne HDK

REF COURONNE ACIER HDK

BETA

125/200/250/300RR 2T ≥ 2013
350/390/430/450/480/498RR
≥ 2013

38300K-48

38300K-49

38300K-50

BETA

250/350/400/450/498/520/525RR
< 2013

GASGAS

EC125/200/250/300/400/450
< 2021

14206K-48

14206K-49

14206K-50

14206K-51

SHERCO

SE 250/300/450/510i

HUSQVARNA

CR 125/250
TC/TE 250/310/449/450/510/570
≤ 2013

HUSQVARNA

TC85 ≥ 2014

KTM

SX85

HONDA

CR 125/250/500R
CRF 250R/250X
CRF 450R/450X
CRF 230F

10212K-46

10212K-47

10212K-48

10212K-49

10212K-50

10212K-51

10212K-52

HUSABERG

FC/FE/MX/ENDURO ≥ 2000

KTM

SX/SX-F/EXC/EXC-F

HUSQVARNA

TC/TE/FC/FE ≥ 2014

GASGAS

EC250/300 ≥ 2021
EC F 250/300 ≥ 2021
MC125 ≥ 2021
MC F 250/450 ≥ 2021

KAWASAKI

KX 125/250/500
KXF 250/450

SUZUKI

RMZ 250 < 2007

SUZUKI

RM 125
RMZ 250 ≥ 2007
RM 250
RMZ 450

YAMAHA

YZ 125
YZ 250
YZ/WR 250F/R
YZ/WR 400/426/450F

REF COURONNE ACIER HDK

71304K-48

71304K-49

71304K-50

71304K-51

71304K-52

16206K-48

16206K-49

16206K-50

16206K-51

16206K-52

14203K-47

14203K-48

14203K-49

14203K-50

14203K-51

12323K-47

12323K-48

12323K-49

12323K-50

12323K-51

12323K-52

12323K-53

Couronne acier SLK superlight

NOUVEAUTÉ

La durabilité, poids plume !

- // COURONNES AU PAS DE 428 OU 520 EN ACIER C45N (ACIER AU CARBONE AVEC NORMALISATION)
- // USINÉ SUR COMMANDE NUMÉRIQUE
- // SUPERLIGHT : GAIN DE POIDS (SL)
- // FINITION : CATAPHORÈSE NOIRE (K)
- // TREMPE PAR INDUCTION SUR LA DENTURE
- // SYSTÈME ANTI-BOUE (+)

AFAM veut offrir à tous les pilotes d'Enduro et de Motocross une couronne acier longue durée avec un poids minimum. Conçue pour tous types de terrain, quelles que soient les conditions météorologiques.

- **LONGUE DURÉE** : Nous utilisons un acier au carbone C45 avec un traitement de normalisation (N) qui assure une trempe optimale. Ensuite, nous procédons à une trempe par induction sur la denture. Ceci garantit une usure minimale de la denture et prolonge également la durée de vie de votre chaîne. La dureté du C45N est d'environ 19HRC et après l'induction de la denture, nous obtenons une dureté qui se situe entre 45 et 50HRC sur une profondeur de 1 à 2mm.



ALU 7075T6	ACIER C45N	ACIER C45N TREMPÉ
11 HRC	19 HRC	48 HRC

- **POUR TOUT TYPE DE TERRAIN** : Comme vous le savez, les différents types de terrains (sableux, boueux ou durs) et les conditions météorologiques ont une influence sur l'usure de votre kit chaîne. Pour cette raison, nous réalisons de part et d'autre de la couronne SLK des dégagements appelés « anti-boue », ceux-ci facilitent l'évacuation de la saleté et garantissent une efficacité optimale de votre transmission quel que soit le type de terrain pratiqué.



Applications couronne SLK

- POIDS MINIMUM** : Le poids non suspendu demeure important. Nous avons donc optimisé le design, afin d'obtenir un poids minimum tout en assurant des performances optimales en toute circonstances.
- TOUS PILOTES** : Cette couronne est dédiée à toutes les machines de 125cc à 450cc. Elle a été testée sur une 450cc MX1 préparée, et dans les pires conditions. Dans le sable et la boue, cette couronne acier SLK a très bien joué son rôle et n'a montré aucune déformation ni usure prématurée.
- USINAGE SUR MACHINE CN** : Afin de respecter les tolérances dimensionnelles/géométriques et d'éviter toute déformation mécanique de l'acier, nous utilisons des machines à commandes numériques de haute précision.

REF COURONNE ACIER SLK+

BETA	250/400/450/520/525 RR > 2012	14206SLK+48 14206SLK+49 14206SLK+50 14206SLK+51
GAS-GAS	EC 125/200/250/300 FSE 400/450	
SHERCO	SE 250/300/450/510i	
HUSQVARNA	CR 125/250 TC/TE > 2013 250/310/449/450/510/570	
BETA	250/300/350/3900/400/430 450/480/498 RR > 2013	38300SLK+48 38300SLK+49 38300SLK+50
HONDA	CR 125/250/500 R CRF 250/450 R	10212SLK+47 10212SLK+48 10212SLK+49 10212SLK+50 10212SLK+51 10212SLK+52
HUSABERG	FC/FE/MX/ENDURO	71304SLK+47 71304SLK+48 71304SLK+49 71304SLK+50 71304SLK+51 71304SLK+52
KTM	SX/SX F/EXC/EXC F	
HUSQVARNA	TC/TE/FC/FE 2014 >	

0,5 X 45i

REF COURONNE ACIER SLK+

KTM	SX 85	# 428	71102SLK+46 71102SLK+49
KAWASAKI	KX 125/250/500 KXF 250/450		16206SLK+48 16206SLK+49 16206SLK+50 16206SLK+51
SUZUKI	RMZ 250	2004-2006	16206SLK+52
SUZUKI	RM 125 RMZ 250 RM250 RMZ 450	2007 >	14203SLK+47 14203SLK+48 14203SLK+49 14203SLK+50 14203SLK+51
YAMAHA	YZ 125 YZ 250 YZ 250F YZ 450F		12323SLK+47 12323SLK+48 12323SLK+49 12323SLK+50 12323SLK+51 12323SLK+52 12323SLK+53

Ra 3.2

Couronnes AFAM

Référence	Désignation
10212K-46	COURONNE ACIER #520 NOIR
10212K-47	COURONNE ACIER #520 NOIR
10212K-48	COURONNE ACIER #520 NOIR
10212K-49	COURONNE ACIER #520 NOIR
10212K-50	COURONNE ACIER #520 NOIR
10212K-51	COURONNE ACIER #520 NOIR
10212K-52	COURONNE ACIER #520 NOIR
10212SLK+46	COURONNE ACIER #520 S/C
10212SLK+47	COURONNE ACIER #520 S/C
10212SLK+48	COURONNE ACIER #520 S/C
10212SLK+49	COURONNE ACIER #520 S/C
10212SLK+50	COURONNE ACIER #520 S/C
10212SLK+51	COURONNE ACIER #520 S/C
10212SLK+52	COURONNE ACIER #520 S/C
12323K-47	COURONNE ACIER #520 NOIR
12323K-48	COURONNE ACIER #520 NOIR
12323K-49	COURONNE ACIER #520 NOIR
12323K-50	COURONNE ACIER #520 NOIR
12323K-51	COURONNE ACIER #520 NOIR
12323K-52	COURONNE ACIER #520 NOIR
12323K-53	COURONNE ACIER #520 NOIR
12323SLK+47	COURONNE ACIER #520 S/C NOIR
12323SLK+48	COURONNE ACIER #520 S/C NOIR
12323SLK+49	COURONNE ACIER #520 S/C NOIR
12323SLK+50	COURONNE ACIER #520 S/C NOIR
12323SLK+51	COURONNE ACIER #520 S/C NOIR
12323SLK+52	COURONNE ACIER #520 S/C NOIR
12323SLK+53	COURONNE ACIER #520 S/C NOIR
14203K-47	COURONNE ACIER #520 NOIR
14203K-48	COURONNE ACIER #520 NOIR
14203K-49	COURONNE ACIER #520 NOIR
14203K-50	COURONNE ACIER #520 NOIR
14203K-51	COURONNE ACIER #520 NOIR
14203SLK+47	COURONNE ACIER #520 S/C
14203SLK+48	COURONNE ACIER #520 S/C
14203SLK+49	COURONNE ACIER #520 S/C
14203SLK+50	COURONNE ACIER #520 S/C
14203SLK+51	COURONNE ACIER #520 S/C

Référence	Désignation
14206K-48	COURONNE ACIER #520 NOIR
14206K-49	COURONNE ACIER #520 NOIR
14206K-50	COURONNE ACIER #520 NOIR
14206K-51	COURONNE ACIER #520 NOIR
14206SLK+48	COURONNE ACIER #520 S/C
14206SLK+49	COURONNE ACIER #520 S/C
14206SLK+50	COURONNE ACIER #520 S/C
14206SLK+51	COURONNE ACIER #520 S/C
16206K-48	COURONNE ACIER #520 NOIR
16206K-49	COURONNE ACIER #520 NOIR
16206K-50	COURONNE ACIER #520 NOIR
16206K-51	COURONNE ACIER #520 NOIR
16206K-52	COURONNE ACIER #520 NOIR
16206SLK+48	COURONNE ACIER #520 S/C
16206SLK+49	COURONNE ACIER #520 S/C
16206SLK+50	COURONNE ACIER #520 S/C
16206SLK+51	COURONNE ACIER #520 S/C
16206SLK+52	COURONNE ACIER #520 S/C
38300SLK+48	COURONNE ACIER #520 S/C
38300SLK+49	COURONNE ACIER #520 S/C
38300SLK+50	COURONNE ACIER #520 S/C
71102K-46	COURONNE ACIER #428 NOIR
71102K-49	COURONNE ACIER #428 NOIR
71102SLK+46	COURONNE ACIER #428 S/C
71102SLK+47	COURONNE ACIER #428 S/C
71102SLK+48	COURONNE ACIER #428 S/C
71102SLK+49	COURONNE ACIER #428 S/C
71304K-48	COURONNE ACIER #520 NOIR
71304K-49	COURONNE ACIER #520 NOIR
71304K-50	COURONNE ACIER #520 NOIR
71304K-51	COURONNE ACIER #520 NOIR
71304K-52	COURONNE ACIER #520 NOIR
71304SLK+48	COURONNE ACIER #520 S/C
71304SLK+49	COURONNE ACIER #520 S/C
71304SLK+50	COURONNE ACIER #520 S/C
71304SLK+51	COURONNE ACIER #520 S/C
71304SLK+52	COURONNE ACIER #520 S/C



Pignons AFAM

Tous les produits AFAM seront disponibles au printemps 2022

Référence	Désignation
20206+13	PIGNON #520 SC
20210+13	PIGNON #520 SC
20210+14	PIGNON #520 SC
20311+13	PIGNON #520 SC
20311+14	PIGNON #520 SC
20311+15	PIGNON #520 SC
20324+13	PIGNON #520 SC
21203+12	PIGNON #520 SC
21203+13	PIGNON #520 SC
21309-13	PIGNON #520
22303+13	PIGNON #520 SC
22303+14	PIGNON #520 SC
22311+13	PIGNON #520 SC
22405+13	PIGNON #520 SC
22405+14	PIGNON #520 SC
22406+13	PIGNON #520 SC
22406+14	PIGNON #520 SC
22408+13	PIGNON #520 SC
22408+14	PIGNON #520 SC
24201+12	PIGNON #520 SC
24201+13	PIGNON #520 SC
24304+13	PIGNON #520 SC
24305+13	PIGNON #520 SC
24305+14	PIGNON #520 SC
27500+13	PIGNON #520 SC
27500+14	PIGNON #520 SC
27502+13	PIGNON #520 SC
27502+14	PIGNON #520 SC
28200+14	PIGNON #428 SC
30300+12	PIGNON #520 SC
30300+13	PIGNON #520 SC
30300+14	PIGNON #520 SC
43304-13	PIGNON #520
43304-14	PIGNON #520
43305-13	PIGNON #520
43303-13	PIGNON #520
64500+13	PIGNON #520 SC
64500+14	PIGNON #520 SC
73301+12	PIGNON #520 SC
73301+13	PIGNON #520 SC
73301+14	PIGNON #520 SC
73301+15	PIGNON #520 SC
94202+13	PIGNON #428 SC
94202+14	PIGNON #428 SC
94313+12	PIGNON #520 SC
94313+13	PIGNON #520 SC

Pignons



Tolérances minimales, combinées à un profil de denture unique, AFAM vous garantit toujours la meilleure qualité pour votre moto haute performance.

Pignons Antiboue

Des rainures antiboue sur chacune des dents dispersent rapidement le sable, la boue et les débris qui peuvent modifier la tension de la chaîne et provoquer une usure prématurée ou la rupture de celle-ci.

Retrouvez toutes les applications des pignons de la p. 302 à la p. 312

CHAÎNES

AFAM Xs RING

NOUVEAUTÉ

La technologie qui fait la différence.

Xs-Ring d'AFAM est conçu pour améliorer l'étanchéité et la lubrification interne de la chaîne et ainsi augmenter considérablement sa durée de vie.

Sa forme spécifique lui confère une grande flexibilité, réduit les frottements et augmente les performances.



Caractéristiques techniques

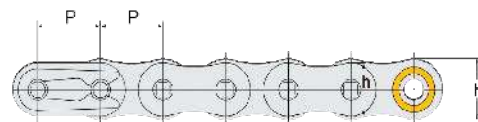
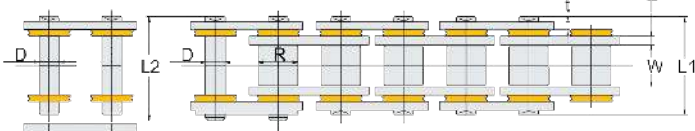

Chaîne	Attache	Joint	Cc	P mm	W mm	R mm	D mm	Épaisseur T/t mm	Hauteur H/h mm	L1 mm	L2 mm	Résistance à la traction daN	Poids / 100 maillons kg
428MX-G	ARS	Sans	125-200	12,7	7,75	8,51	4,50	1,8	12/10,4	19	20	2400	1,02
520MR2-G	ARS	Sans	125-250	15,88	6,35	10,16	5,24	2	15/13	18,9	19,8	3400	1,64
520MX6	ARS	Sans	250-500	15,88	6,35	10,16	5,24	2	15/13	16,8	18,8	3740	1,51
520XLR2	ARS	Xs	125-400	15,88	6,35	10,16	5,24	2	15/13	19,9	20,7	330	1,66
520XRR3-G	ARS	Xs	125-500	15,88	6,35	10,16	5,24	2	15/13	19,8	21	3600	1,58





520MX6-G



520MX6-K



520XLR2



520XRR3-G



520XRR3-K

Chaînes

428 MX-G

Chaîne particulièrement adaptée aux 85cc. Plaques et rouleaux de qualité supérieure. Les goupilles chromées réduisent l'usure.

520 MR2-G

Cette chaîne de couleur or est notre produit d'entrée de gamme Motocross. Idéal pour amateurs comme pour les pilotes plus expérimentés, cette chaîne est le fruit d'une technologie de pointe : bagues et galets forgés pour une meilleure résistance.

520MX6-G / MX6-K

Chaîne de qualité professionnelle, couleur "OR" ou "Black". Cette chaîne bénéficie des avancées techniques développées pour le MX1 : broches chromées, douilles et rouleaux forgés, acier de haute qualité pour une durée de vie plus longue.

520XLR2

Qualité de chaîne AFAM de base, avec joint Xs, motos route ou offroad de 125 à 400 cc.

520XRR3-G / XRR3-K

Chaîne à la qualité améliorée avec joint Xs. Il s'agit d'une chaîne universelle. Excellent rapport qualité/prix, couleur or, résistance à la traction accrue.



ARS

Attaches montage libre

Mini rive chaîne

NOUVEAUTÉ

23,95 €
T.T.C.

Pratique et simple d'utilisation

DETAIL B



POUSSE PLAQUETTE

Cet outil permet de presser la plaquette sur le maillon de fermeture, utilisable sur maillon à clips, maillon à riveter avec axes creux ou maillon à riveter avec axes pleins.

ÉVITE L'ÉCRASEMENT DU MAILLON

Son concept indique et contrôle la poussée de la plaquette sur le maillon, respecte la bonne largeur de la chaîne et assure la bonne pression sur les joints.

RIVETAGE DES AXES CREUX

Cet outil vous permet de riveter les maillons de fermeture à axes creux.

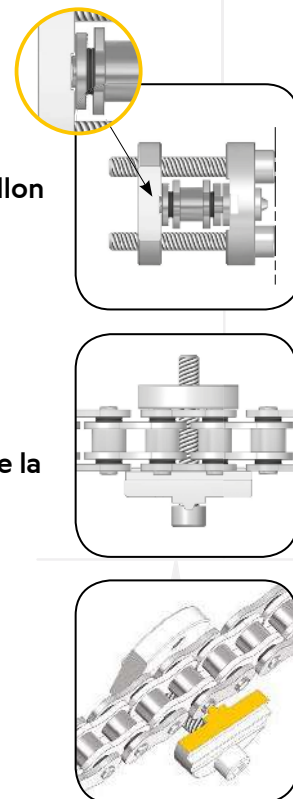

Mini rive chaîne - EASYRIV5

POUR CHAINES : 520-525-530



Ra 3,2

Chaînes AFAM

Référence	Désignation
A428MXG118L	Chaînee A428MX-G 118L ARS GOLD
A428MXG120L	Chaînee A428MX-G 120L ARS GOLD
A428MXG124L	Chaînee A428MX-G 124L ARS GOLD
A428MXG128L	Chaînee A428MX-G 128L ARS GOLD
A428MXG130L	Chaînee A428MX-G 130L ARS GOLD
A520MX5GG112L	Chaînee A620MX6-GG 112L ARS GGOLD
A520MX6GG114L	Chaînee A620MX6-GG 114L ARS GGOLD
A520MX6GG116L	Chaînee A620MX6-GG 116L ARS GGOLD
A520MX6GG118L	Chaînee A620MX6-GG 118L ARS GGOLD
A520MX6GG120L	Chaînee A620MX6-GG 120L ARS GGOLD
A520MX6K112L	Chaînee A520MX6-K 112L ARS BLACK
A520MX6K114L	Chaînee A520MX6-K 114L ARS BLACK
A520MX6K116L	Chaînee A520MX6-K 116L ARS BLACK
A520MX6K118L	Chaînee A520MX6-K 118L ARS BLACK
A520MX6K120L	Chaînee A520MX6-K 120L ARS BLACK
A520XLR2110L	Chaîne A520XLR2 110L ARS
A520XLR2112L	Chaîne A520XLR2 112L ARS
A520XLR2114L	Chaîne A520XLR2 114L ARS
A520XLR2116L	Chaîne A520XLR2 116L ARS
A520XLR2118L	Chaîne A520XLR2 118L ARS
A520XLR2120L	Chaîne A520XLR2 120L ARS
A520XRR3K112L	Chaînee A520XRR3-K 112L ARS BLACK
A520XRR3K114L	Chaînee A520XRR3-K 114L ARS BLACK
A520XRR3K116L	Chaînee A520XRR3-K 116L ARS BLACK
A520XRR3K118L	Chaînee A520XRR3-K 118L ARS BLACK
A520XRR3K120L	Chaînee A520XRR3-K 120L ARS BLACK
A520XRR3G112L	Chaînee A520XRR3-G 112L ARS GOLD
A520XRR3G114L	Chaînee A520XRR3-G 114L ARS GOLD
A520XRR3G116L	Chaînee A520XRR3-G 116L ARS GOLD
A520XRR3G118L	Chaînee A520XRR3-G 118L ARS GOLD
A520XRR3G120L	Chaînee A520XRR3-G 120L ARS GOLD
A520MR2G110L	Chaîne A520MR2-G 110L ARS GOLD
A520MR2G112L	Chaîne A520MR2-G 112L ARS GOLD
A520MR2G114L	Chaîne A520MR2-G 114L ARS GOLD
A520MR2G116L	Chaîne A520MR2-G 116L ARS GOLD
A520MR2G118L	Chaîne A520MR2-G 118L ARS GOLD
A520MR2G120L	Chaîne A520MR2-G 120L ARS GOLD
ARSA520MX6GG	Attache Rapide A520MX6-GG
ARSA520MX6K	Attache Rapide A520MX6-K
ARSA520XLR2	Attache Rapide A520XLR2
ARSA520XRR3G	Attache Rapide A520XRR3-G
ARSA520XRR3K	Attache Rapide A520XRR3-K
ARSA428MXG	Attache Rapide A428MX-G

Équivalence AFAM / DID

AFAM	Joints	DID
A428MX-G	Non	428NZ (G&B)
A520MR2-G	Non	DID520DZ2
A520XLR2	Oui	NEW
A520MX6-K	Non	520ERT3 (G&G)
A520MX6-G	Non	520ERT3 (G&G)
A520XRR3-K	Oui	520VX3 (B&B)
A520XRR3-G	Oui	520VX3 (G&B)

Tous les produits AFAM seront disponibles au printemps 2022



TRANSMISSION

Cyl.	Modèle	Année	Pignon	Couronne SLK	Couronne HDK	Chaîne	Pas	Longueur
BETA								
125	RR 125 Enduro / Enduro Racing	18-22	73301+13	38300SLK+50		A520XRR3-G 114L	520	114
200	RR 200 Enduro	19-22	73301+14	38300SLK+49		A520XRR3-G 116L	520	116
250	250 X-Trainer	19-19	73301+15	38300SLK+48		A520XRR3-G 112L	520	112
250	250 X-Trainer	20-22	73301+14	38300SLK+49		A520XRR3-G 114L	520	114
250	RR 250 Enduro / Enduro Racing	13-16	73301+13	38300SLK+49		A520XRR3-G 114L	520	114
250	RR 250 Enduro / Enduro Racing	17-22	73301+14	38300SLK+49		A520XRR3-G 114L	520	114
300	300 X-Trainer	19-19	73301+15	38300SLK+48		A520XRR3-G 112L	520	112
300	300 X-Trainer	20-22	73301+14	38300SLK+49		A520XRR3-G 114L	520	114
300	RR 300 Enduro / Enduro Racing	13-16	73301+13	38300SLK+49		A520XRR3-G 114L	520	114
300	RR 300 Enduro / Enduro Racing	17-19	73301+14	38300SLK+49		A520XRR3-G 114L	520	114
300	RR 300 Enduro / Enduro Racing	20-22	73301+14	38300SLK+48		A520XRR3-G 114L	520	114
350	RR 350 EFI Enduro / Enduro Racing	15-19	73301+13	38300SLK+50		A520XRR3-G 114L	520	114
350	RR 350 EFI Enduro / Enduro Racing	20-22	73301+13	38300SLK+50		A520XRR3-G 116L	520	116
350	RR 350 Enduro	11-12	73301+13	14206SLK+50	14206K-50	A520XRR3-G 114L	520	114
350	RR 350 Enduro / Enduro Racing	13-15	73301+13	38300SLK+50		A520XRR3-G 114L	520	114
350	RR-S 350	18-19	73301+13	38300SLK+48		A520XRR3-G 114L	520	114
350	RR-S 350	20-20	73301+13	38300SLK+48		A520XRR3-G 116L	520	116
390	RR 390 EFI Enduro / Enduro Racing	15-19	73301+13	38300SLK+49		A520XRR3-G 114L	520	114
390	RR 390 EFI Enduro / Enduro Racing	20-22	73301+13	38300SLK+49		A520XRR3-G 116L	520	116
390	RR-S 390 Enduro 4T	18-19	73301+13	38300SLK+48		A520XRR3-G 114L	520	114
390	RR-S 390 Enduro 4T	20-20	73301+13	38300SLK+48		A520XRR3-G 114L	520	114
400	RR 400 Enduro	05-09	73301+14	14206SLK+50	14206K-50	A520XRR3-G 114L	520	114
400	RR 400 Enduro	10-11	73301+13	14206SLK+48	14206K-48	A520XRR3-G 112L	520	112
400	RR 400 Enduro	12-12	73301+13	14206SLK+50	14206K-50	A520XRR3-G 114L	520	114
400	RR 400 Enduro	13-14	73301+13	38300SLK+50		A520XRR3-G 114L	520	114
430	RR 430 EFI Enduro / Enduro Racing	16-19	73301+13	38300SLK+48		A520XRR3-G 112L	520	112
430	RR 430 EFI Enduro / Enduro Racing	20-22	73301+13	38300SLK+49		A520XRR3-G 116L	520	116
430	RR 430 Enduro / Enduro Racing	15-15	73301+13	38300SLK+48		A520XRR3-G 112L	520	112
430	RR-S 430	18-19	73301+13	38300SLK+48		A520XRR3-G 114L	520	114
430	RR-S 430	20-21	73301+13	38300SLK+48		A520XRR3-G 116L	520	116
450	RR 450 Enduro	05-08	73301+14	14206SLK+50	14206K-50	A520XRR3-G 114L	520	114
450	RR 450 Enduro	10-10	73301+13	14206SLK+48	14206K-48	A520XRR3-G 112L	520	112
450	RR 450 Enduro	11-12	73301+13	14206SLK+48	14206K-48	A520XRR3-G 112L	520	112
450	RR 450 Enduro	13-13	73301+13	38300SLK+48		A520XRR3-G 112L	520	112
450	RR 450 Enduro / Enduro Racing	06-09	73301+14	14206SLK+50	14206K-50	A520XRR3-G 114L	520	114
450	RR 450 Enduro / Enduro Racing	14-14	73301+13	38300SLK+48		A520XRR3-G 112L	520	112
450	RR 450 Enduro Racing	13-13	73301+13	38300SLK+48		A520XRR3-G 112L	520	112
480	RR 480 EFI Enduro / Enduro Racing	15-19	73301+13	38300SLK+49		A520XRR3-G 112L	520	112
480	RR 480 EFI Enduro / Enduro Racing	20-22	73301+13	38300SLK+49		A520XRR3-G 116L	520	116
498	RR 498 Enduro	12-12	73301+13	14206SLK+48	14206K-48	A520XRR3-G 112L	520	112
498	RR 498 Enduro	13-13	73301+13	38300SLK+48		A520XRR3-G 112L	520	112
498	RR 498 Enduro / Enduro Racing	14-14	73301+13	38300SLK+48		A520XRR3-G 112L	520	112
520	RR 520 Enduro	10-11	73301+13	14206SLK+48	14206K-48	A520XRR3-G 112L	520	112
525	RR 525 Enduro	05-08	73301+14	14206SLK+50	14206K-50	A520XRR3-G 114L	520	114
525	RR 525 Enduro / Enduro Racing	06-09	73301+14	14206SLK+50	14206K-50	A520XRR3-G 114L	520	114
FANTIC								
125	XE 125	22-22	21309-13	12323SLK+50	12323K-50	A520MR2-G 114L	520	114
125	XX 125	22-22	21309-13	12323SLK+48	12323K-48	A520MR2-G 114L	520	114
250	XEF 250	21-22	21309-13	12323SLK+51	12323K-51	A520MR2-G 114L	520	114



Cyl.	Modèle	Année	Pignon	Couronne SLK	Couronne HDK	Chaîne	Pas	Longueur
GAS-GAS								
85	MC 85 Big Wheels	21-22	94202+13	71102SLK+49	71102K-49	A428MX-G 124L	428	124
125	EC 125	03-12	21203+13	14206SLK+48	14206K-48	A520XRR3-G 112L	520	112
125	EC 125	13-13	21203+13	14206SLK+50	14206K-50	A520XRR3-G 114L	520	114
125	EC 125 R	14-14	21203+13	14206SLK+50	14206K-50	A520XRR3-G 114L	520	114
125	MC 125	21-22	73301+13	71304SLK+51	71304K-51	A520MR2-G 116L	520	116
200	EC 200	03-17	94313+12	14206SLK+48	14206K-48	A520XRR3-G 112L	520	112
200	EC 200 E4	18-18	94313+13	14206SLK+49	14206K-49	A520XRR3-G 114L	520	114
200	EC 200 E4	19-20	94313+12	14206SLK+50	14206K-50	A520XRR3-G 114L	520	114
200	EC 200 ER	14-17	94313+12	14206SLK+48	14206K-48	A520XRR3-G 112L	520	112
200	EC 200 Ranger	19-20	94313+12	14206SLK+50	14206K-50	A520XRR3-G 114L	520	114
200	XC 200	18-18	94313+13	14206SLK+49	14206K-49	A520XRR3-G 114L	520	114
200	XC 200	19-19	94313+12	14206SLK+50	14206K-50	A520XRR3-G 114L	520	114
250	EC 250	01-17	94313+13	14206SLK+48	14206K-48	A520XRR3-G 112L	520	112
250	EC 250	21-22	73301+13	71304SLK+52	71304K-52	A520XRR3-G 116L	520	116
250	EC 250 E4	18-19	94313+13	14206SLK+49	14206K-49	A520XRR3-G 114L	520	114
250	EC 250 E4 Six Days	19-19	94313+13	14206SLK+49	14206K-49	A520XRR3-G 114L	520	114
250	EC 250 ER	14-17	94313+13	14206SLK+48	14206K-48	A520XRR3-G 112L	520	112
250	EC 250 F	10-12	21309-13	14206SLK+50	14206K-50	A520XRR3-G 116L	520	116
250	EC 250 F	13-15	21309-13	14206SLK+48	14206K-48	A520XRR3-G 114L	520	114
250	EC-F 250	21-22	73301+13	71304SLK+52	71304K-52	A520XRR3-G 118L	520	118
250	EX-F 250	21-21	73301+13	71304SLK+51	71304K-51	A520MX6-GG 116L	520	116
250	MC 250	03-05	94313+12	14206SLK+48	14206K-48	A520MX6-GG 114L	520	114
250	MC-F 250	21-22	73301+14	71304SLK+51	71304K-51	A520MX6-GG 118L	520	118
250	XC 250	18-19	94313+13	14206SLK+49	14206K-49	A520XRR3-G 114L	520	114
300	EC 300	01-15	94313+13	14206SLK+48	14206K-48	A520XRR3-G 112L	520	112
300	EC 300	21-22	73301+13	71304SLK+50	71304K-50	A520XRR3-G 116L	520	116
300	EC 300 E4	18-19	94313+13	14206SLK+48	14206K-48	A520XRR3-G 112L	520	112
300	EC 300 ER	14-17	94313+13	14206SLK+48	14206K-48	A520XRR3-G 112L	520	112
300	EC 300 F	13-13	21309-13	14206SLK+50	71304K-50	A520XRR3-G 116L	520	116
300	EC 300 F	14-15	21309-13	14206SLK+48	14206K-48	A520XRR3-G 114L	520	114
300	EC 300 Ranger	19-20	94313+13	14206SLK+48	14206K-48	A520XRR3-G 112L	520	112
300	EX 300	21-21	73301+13	71304SLK+51	71304K-51	A520MX6-GG 116L	520	116
300	XC 300	18-19	94313+13	14206SLK+48	14206K-48	A520XRR3-G 112L	520	112
350	EC-F 350	21-22	73301+13	71304SLK+52	71304K-52	A520XRR3-G 116L	520	116
350	EX-F 350	21-21	73301+14	71304SLK+51	71304K-51	A520MX6-GG 118L	520	118
400	EC 400 FSE	02-02	94313+13	14206SLK+48	14206K-48	A520XRR3-G 116L	520	116
450	EC 450 F	13-15	27500+13	14206SLK+48	14206K-48	A520XRR3-G 114L	520	114
450	EC 450 FSE Enduro	03-09	94313+13	14206SLK+48	14206K-48	A520XRR3-G 116L	520	116
450	EX-F 450	21-21	73301+13	71304SLK+50	71304K-50	A520MX6-GG 116L	520	116
450	MC-F 450	21-22	73301+13	71304SLK+49	71304K-49	A520MX6-GG 116L	520	116
HM-HONDA								
125	CRE 125 R Enduro	02-03	20206+13	10212SLK+49	10212K-49	A520XRR3-G 116L	520	116
125	CRE 125 R Enduro	04-07	20210+13	10212SLK+49	10212K-49	A520XRR3-G 114L	520	114
250	CRE 250 R Enduro	02-03	20311+13	10212SLK+47	10212K-47	A520XRR3-G 112L	520	112
250	CRE 250 R Enduro	04-07	20311+13	10212SLK+47	10212K-47	A520XRR3-G 114L	520	114
250	CRE F 250 R	04-09	20210+13	10212SLK+49	10212K-49	A520XRR3-G 114L	520	114
250	CRE F 250 R	10-10	20210+13	10212SLK+48	10212K-48	A520XRR3-G 116L	520	116
250	CRE F 250 R	11-16	20210+13	10212SLK+49	10212K-49	A520XRR3-G 116L	520	116
250	CRF 250 F	04-08	20210+13	10212SLK+49	10212K-49	A520XRR3-G 114L	520	114

TRANSMISSION

Cyl.	Modèle	Année	Pignon	Couronne SLK	Couronne HDK	Chaîne	Pas	Longueur
HM-HONDA								
250	CRF 250 R	08-09	20210+13	10212SLK+49	10212K-49	A520XRR3-G 114L	520	114
300	CRE F 300 R	12-15	20210+13	10212SLK+49	10212K-49	A520XRR3-G 116L	520	116
450	CRE 450 F	02-02	20311+13	10212SLK+48	10212K-48	A520XRR3-G 114L	520	114
450	CRE 450 R Enduro	02-03	20311+13	10212SLK+48	10212K-48	A520XRR3-G 114L	520	114
450	CRE 450 R Enduro	04-07	20311+13	10212SLK+50	10212K-50	A520XRR3-G 116L	520	116
450	CRE F 450 R Enduro	04-08	20311+13	10212SLK+50	10212K-50	A520XRR3-G 116L	520	116
450	CRE F 450 R Enduro	09-16	20311+13	10212SLK+48	10212K-48	A520XRR3-G 116L	520	116
450	CRE F 450 X	04-16	20311+13	10212SLK+51	10212K-51	A520XRR3-G 116L	520	116
450	CRF 450 R	04-08	20311+13	10212SLK+50	10212K-50	A520XRR3-G 116L	520	116
450	CRF 450 R	09-09	20311+13	10212SLK+48	10212K-48	A520XRR3-G 116L	520	116
500	CRE F 500 X	08-16	20311+13	10212SLK+51	10212K-51	A520XRR3-G 116L	520	116
HONDA								
125	CR 125 R H,J,K,L,M,N,P,R,S,T	87-96	20206+13	10212SLK+51	10212K-51	A520MR2-G 114L	520	114
125	CR 125 R W,X	98-99	20206+13	10212SLK+51	10212K-51	A520MR2-G 114L	520	114
125	CR 125 R Y,1	00-01	20206+13	10212SLK+52	10212K-52	A520MR2-G 116L	520	116
125	CR 125 R 2	02-02	20206+13	10212SLK+51	10212K-51	A520MR2-G 114L	520	114
125	CR 125 R 3	03-03	20206+13	10212SLK+52	10212K-52	A520MR2-G 116L	520	116
125	CR 125 R 5,6,7	05-07	20210+13	10212SLK+52	10212K-52	A520MR2-G 116L	520	116
250	CR 250 R N,P	92-93	20311+13	10212SLK+49	10212K-49	A520MR2-G 112L	520	112
250	CR 250 R R,S	94-95	20311+13	10212SLK+49	10212K-49	A520MR2-G 114L	520	114
250	CR 250 R T,V,W,X,Y	96-00	20311+13	10212SLK+50	10212K-50	A520MR2-G 114L	520	114
250	CR 250 R 1	01-01	20311+13	10212SLK+50	10212K-50	A520MR2-G 114L	520	114
250	CR 250 R 2	02-02	20311+14	10212SLK+48	10212K-48	A520MR2-G 114L	520	114
250	CR 250 R 3	03-03	20311+13	10212SLK+48	10212K-48	A520MR2-G 114L	520	114
250	CR 250 R 4	04-04	20311+13	10212SLK+50	10212K-50	A520MR2-G 114L	520	114
250	CR 250 R 5	05-05	20311+13	10212SLK+48	10212K-48	A520MX6-GG 114L	520	114
250	CR 250 R 6,7	06-07	20311+13	10212SLK+49	10212K-49	A520MX6-GG 114L	520	114
250	CRF 250 R 4,5,6,7,8,9	04-09	20210+13	10212SLK+51	10212K-51	A520MX6-GG 114L	520	114
250	CRF 250 R A	10-10	20210+13	10212SLK+48	10212K-48	A520MX6-GG 116L	520	116
250	CRF 250 R B,C,D,E,F,G,G,H	11-17	20210+13	10212SLK+49	10212K-49	A520MX6-GG 116L	520	116
250	CRF 250 R J,K,L,M,N	18-22	20324+13	10212SLK+49	10212K-49	A520MX6-GG 114L	520	114
250	CRF 250 R USA B,C	11-12	20210+13	10212SLK+49	10212K-49	A520MX6-GG 116L	520	116
250	CRF 250 RX N	22-22	20324+13	10212SLK+49	10212K-49	A520MX6-GG 114L	520	114
450	CRF 450 R 2,3	02-03	20311+13	10212SLK+50	10212K-50	A520MX6-GG 114L	520	114
450	CRF 450 R 4,5,6,7,8	04-08	20311+13	10212SLK+48	10212K-48	A520MX6-GG 114L	520	114
450	CRF 450 R 9,A,B,C,D,E,F,G	09-16	20311+13	10212SLK+48	10212K-48	A520MX6-GG 116L	520	116
450	CRF 450 R H,J,K,L,M,N	17-22	20311+13	10212SLK+49	10212K-49	A520MX6-GG 114L	520	114
450	CRF 450 RX H,J,K,L,M,N	17-22	20311+13	10212SLK+50	10212K-50	A520XRR3-G 114L	520	114
450	CRF 450 X 5,6,7,8,9,A,B,C,D,E,F,G,H,J	05-18	20311+13	10212SLK+51	10212K-51	A520XRR3-G 114L	520	114
500	CR 500 R N,P,R,S,T,V,W,X,Y,1	92-01	20311+14	10212SLK+49	10212K-49	A520MX6-GG 114L	520	114
HUSABERG								
125	TE 125	12-14	73301+13	71304SLK+50	71304K-50	A520XRR3-G 116L	520	116
250	FE 250 e	11-14	73301+13	71304SLK+52	71304K-52	A520XRR3-G 118L	520	118
250	TE 250	11-14	73301+13	71304SLK+50	71304K-50	A520XRR3-G 116L	520	116
300	TE 300	11-14	73301+13	71304SLK+50	71304K-50	A520XRR3-G 116L	520	116
350	FE 350 e	13-14	73301+13	71304SLK+52	71304K-52	A520XRR3-G 118L	520	118
390	FE 390 e	10-12	73301+13	71304SLK+52	71304K-52	A520XRR3-G 118L	520	118
450	FE 450	08-14	73301+13	71304SLK+52	71304K-52	A520XRR3-G 118L	520	118
501	FE 501	13-14	73301+14	71304SLK+52	71304K-52	A520XRR3-G 118L	520	118
570	FE 570	09-12	73301+13	71304SLK+52	71304K-52	A520XRR3-G 116L	520	116



Cyl.	Modèle	Année	Pignon	Couronne SLK	Couronne HDK	Chaîne	Pas	Longueur
HUSQVARNA								
85	TC 85 Big Wheels	14-17	94202+14	71102SLK+49	71102K-49	A428MX-G 124L	428	124
85	TC 85 Big Wheels	18-22	94202+13	71102SLK+49	71102K-49	A428MX-G 124L	428	124
85	TC 85 Small Wheels	14-17	94202+14	71102SLK+46	71102K-46		428	122
85	TC 85 Small Wheels	18-22	94202+13	71102SLK+46	71102K-46		428	122
125	TC 125	14-19	73301+13	71304SLK+50	71304K-50	A520MR2-G 116L	520	116
125	TC 125	20-22	73301+13	71304SLK+51	71304K-51	A520MR2-G 116L	520	116
125	TE 125	14-17	73301+13	71304SLK+50	71304K-50	A520XRR3-G 116L	520	116
125	TX 125	18-19	73301+13	71304SLK+50	71304K-50	A520XRR3-G 116L	520	116
150	TE 150	18-22	73301+13	71304SLK+50	71304K-50	A520XRR3-G 116L	520	116
250	CR 250	00-07	64500+13	14206SLK+48	14206K-48	A520MR2-G 114L	520	114
250	FC 250	14-16	73301+13	71304SLK+50	71304K-50	A520MX6-GG 116L	520	116
250	FC 250	17-22	73301+14	71304SLK+51	71304K-51	A520MX6-GG 118L	520	118
250	FE 250	14-22	73301+13	71304SLK+52	71304K-52	A520XRR3-G 118L	520	118
250	TC 250	02-03	64500+14	14206SLK+50	14206K-50	A520MX6-GG 116L	520	116
250	TC 250	04-05	64500+13	14206SLK+50	14206K-50	A520MX6-GG 116L	520	116
250	TC 250	14-16	73301+13	71304SLK+48	71304K-48	A520MX6-GG 114L	520	114
250	TC 250	17-20	73301+14	71304SLK+50	71304K-50	A520MX6-GG 116L	520	116
250	TE 250	02-03	64500+14	14206SLK+50	14206K-50	A520XRR3-G 116L	520	116
250	TE 250	04-09	64500+13	14206SLK+50	14206K-50	A520XRR3-G 116L	520	116
250	TE 250	14-17	73301+13	71304SLK+50	71304K-50	A520XRR3-G 116L	520	116
250	TE 250 i	18-21	73301+13	71304SLK+50	71304K-50	A520XRR3-G 116L	520	116
250	TE 250 i	22-22	73301+13	71304SLK+52	71304K-52	A520XRR3-G 118L	520	118
250	TXC 250	08-10	64500+13	14206SLK+50	14206K-50	A520XRR3-G 116L	520	116
250	WR 250	99-00	64500+14	14206SLK+48	14206K-48	A520XRR3-G 114L	520	114
250	WR 250	01-13	64500+13	14206SLK+48	14206K-48	A520XRR3-G 114L	520	114
300	TE 300	14-17	73301+13	71304SLK+50	71304K-50	A520XRR3-G 116L	520	116
300	TE 300 i	18-22	73301+13	71304SLK+50	71304K-50	A520XRR3-G 116L	520	116
300	TX 300 i	18-19	73301+13	71304SLK+50	71304K-50	A520XRR3-G 116L	520	116
300	TX 300 i	20-22	73301+13	71304SLK+51	71304K-51	A520XRR3-G 116L	520	116
300	WR 300	09-13	64500+13	14206SLK+48	14206K-48	A520XRR3-G 114L	520	114
310	TE 310	09-10	64500+13	14206SLK+50	14206K-50	A520XRR3-G 116L	520	116
350	FC 350	14-19	73301+14	71304SLK+50	71304K-50	A520MX6-GG 116L	520	116
350	FC 350	20-22	73301+14	71304SLK+51	71304K-51	A520MX6-GG 118L	520	118
350	FE 350	14-22	73301+13	71304SLK+52	71304K-52	A520XRR3-G 118L	520	118
350	FE 350 S	20-20	73301+13	71304SLK+52	71304K-52	A520XRR3-G 118L	520	118
350	FX 350	17-19	73301+14	71304SLK+50	71304K-50	A520MX6-GG 116L	520	116
350	FX 350	20-22	73301+14	71304SLK+51	71304K-51	A520XRR3-G 116L	520	116
410	TE 410	95-01	64500+13	14206SLK+48	14206K-48	A520XRR3-G 116L	520	116
410	TE 410 E	00-00	64500+13	14206SLK+48	14206K-48	A520XRR3-G 116L	520	116
450	FC 450	14-15	73301+13	71304SLK+50	71304K-50	A520MX6-GG 116L	520	116
450	FC 450	16-19	73301+13	71304SLK+48	71304K-48	A520MX6-GG 114L	520	114
450	FC 450	20-22	73301+13	71304SLK+49	71304K-49	A520MX6-GG 116L	520	116
450	FE 450	14-22	73301+13	71304SLK+52	71304K-52	A520XRR3-G 118L	520	118
450	FX 450	17-22	73301+13	71304SLK+48	71304K-48	A520MX6-GG 114L	520	114
450	TC 450	02-10	64500+14	14206SLK+50	14206K-50	A520MX6-GG 116L	520	116
450	TE 450	02-10	64500+14	14206SLK+50	14206K-50	A520XRR3-G 116L	520	116
501	FE 501	14-22	73301+13	71304SLK+50	71304K-50	A520XRR3-G 116L	520	116
510	TE 510	90-91	64500+14	14206SLK+48	14206K-48	A520XRR3-G 116L	520	116
510	TE 510	04-04	64500+14	14206SLK+50	14206K-50	A520XRR3-G 116L	520	116

TRANSMISSION

Cyl.	Modèle	Année	Pignon	Couronne SLK	Couronne HDK	Chaîne	Pas	Longueur
HUSQVARNA								
510	TE 510	05-10	64500+14	14206SLK+50	14206K-50	A520XRR3-G 116L	520	116
610	TE 610	91-00	64500+14	14206SLK+48	14206K-48	A520XRR3-G 116L	520	116
KAWASAKI								
125	KX 125 K1,K2	94-95	24201+12	16206SLK+49	16206K-49	A520MR2-G 110L	520	110
125	KX 125 K3,K4	96-97	24201+13	16206SLK+50	16206K-50	A520MR2-G 112L	520	112
125	KX 125 K5,L1	98-99	24201+12	16206SLK+48	16206K-48	A520MR2-G 112L	520	112
125	KX 125 L2,L3,L4	00-02	24201+12	16206SLK+49	16206K-49	A520MR2-G 110L	520	110
125	KX 125 M1	03-03	24201+13	16206SLK+50	16206K-50	A520MR2-G 112L	520	112
125	KX 125 M2,M3,M6F,M7F,M8F	04-08	24201+13	16206SLK+50	16206K-50	A520MR2-G 114L	520	114
200	KDX 200 A2,A3	84-85	30300+13	16206SLK+48	16206K-48	A520XRR3-G 112L	520	112
200	KDX 200 C1,C2,C3	86-88	30300+13	16206SLK+48	16206K-48		520	110
200	KDX 200 E1,E2,E3,E4,E5,E6	89-94	30300+13	16206SLK+47	16206K-47		520	110
200	KDX 200 H1,H2,H3,H4,H5,H6,H7,H8,H9,H10,H11,H6F	95-06	30300+13	16206SLK+47	16206K-47		520	108
220	KDX 220 R A4,A5,A6,A7,A8,A9,A10,A11,A12,A6F	97-06	30300+13	16206SLK+47	16206K-47		520	108
250	KDX 250 D1,D2,D3,D4,D5	91-95	30300+14	16206SLK+48	16206K-48	A520XRR3-G 112L	520	112
250	KLX 250 R D1,D2,D3,D4,D5,D6,D7	93-99	30300+14	16206SLK+50	16206K-50		520	110
250	KX 250 J1,J2	92-93	30300+14	16206SLK+49	16206K-49	A520MR2-G 114L	520	114
250	KX 250 K1,K2,K3	94-96	30300+14	16206SLK+49	16206K-49	A520MR2-G 112L	520	112
250	KX 250 K4,K5	97-98	30300+14	16206SLK+49	16206K-49	A520MR2-G 114L	520	114
250	KX 250 L1,L2,L3,L4	99-02	27500+14	16206SLK+49	16206K-49	A520MR2-G 114L	520	114
250	KX 250 M1,M2	03-04	27500+13	16206SLK+49	16206K-49	A520MR2-G 114L	520	114
250	KX 250 R1,R6F,R7F,R8F	05-08	27500+13	16206SLK+50	16206K-50	A520MX6-GG 116L	520	116
250	KX 250 AJF,AKF,BLF,M	18-21	24305+13	16206SLK+50	16206K-50	A520MX6-GG 114L	520	114
250	KX 250 F N1,N2	04-05	24304+13	16206SLK+48	16206K-48	A520MX6-GG 114L	520	114
250	KX 250 F T6F,T7F,T8F,W9F,XAF	06-10	24305+13	16206SLK+48	16206K-48	A520MX6-GG 112L	520	112
250	KX 250 F YBF,YCF	11-12	24305+13	16206SLK+49	16206K-49	A520MX6-GG 114L	520	114
250	KX 250 F ZDF,ZEF,ZFF,ZGF,AHF	13-17	24305+13	16206SLK+50	16206K-50	A520MX6-GG 114L	520	114
250	KX 250 X KX252D M,N	21-22	24305+13	16206SLK+51	16206K-51	A520MX6-GG 114L	520	114
300	KLX 300 R A2,A3,A4,A5,A6	97-01	30300+14	16206SLK+50	16206K-50		520	110
300	KLX 300 R A7,A8,A9,A10,A6F,A7F	02-07	27500+14	16206SLK+50	16206K-50		520	110
400	KLX 400 R B1,B2	03-04	22303+14	14203SLK+47	14203K-47	A520XRR3-G 112L	520	112
450	KLX 450 R A7F,A8F,A9F,AAF,ABF	07-11	27502+13	16206SLK+50	16206K-50	A520XRR3-G 114L	520	114
450	KLX 450 R KLX450A CF,DF,EF,F,G,H,J,K,L,M	12-21	27502+13	16206SLK+50	16206K-50	A520XRR3-G 114L	520	114
450	KX F,D6F,D7F,D8F,E9F,EAF,EBF,FCF,FD,FEF,FFF,HGF,HHF,HJF	06-18	27502+13	16206SLK+50	16206K-50	A520MX6-GG 114L	520	114
450	KX 450 KX450J K,L,M,N	19-22	27502+13	16206SLK+50	16206K-50	A520MX6-GG 114L	520	114
450	KX 450 XC KX450K M,N	21-22	27502+13	16206SLK+51	16206K-51	A520MX6-GG 114L	520	114
500	KX 500 C1,D1,E1...E16	87-04	30300+14	16206SLK+47	16206K-47	A520MX6-GG 114L	520	114
KTM								
85	SX 85 Big wheels	07-17	94202+14	71102SLK+49	71102K-49	A428MX-G 124L	428	124
85	SX 85 Big wheels	18-22	94202+13	71102SLK+49	71102K-49	A428MX-G 124L	428	124
85	SX 85 Small wheels	03-17	94202+14	71102SLK+46	71102K-46		428	122
85	SX 85 Small wheels	18-22	94202+13	71102SLK+46	71102K-46		428	122
105	SX 105	04-06	94202+14	71102SLK+49	71102K-49		428	122
125	EXC 125	96-98	73301+13	71304SLK+50	71304K-50	A520XRR3-G 112L	520	112
125	EXC 125	99-16	73301+13	71304SLK+50	71304K-50	A520XRR3-G 116L	520	116
125	EXC 125 Champion Edition	10-10	73301+13	71304SLK+50	71304K-50	A520XRR3-G 116L	520	116
125	EXC 125 Factory Edition	11-11	73301+13	71304SLK+50	71304K-50	A520XRR3-G 116L	520	116
125	EXC 125 Six Days	01-16	73301+13	71304SLK+50	71304K-50	A520XRR3-G 116L	520	116
125	GS 125	94-97	73301+13	71304SLK+50	71304K-50		520	110



Cyl.	Modèle	Année	Pignon	Couronne SLK	Couronne HDK	Chaîne	Pas	Longueur
125	SX 125	94-97	73301+13	71304SLK+50	71304K-50	A520MR2-G 110L	520	110
125	SX 125	98-98	73301+13	71304SLK+50	71304K-50	A520MR2-G 112L	520	112
125	SX 125	99-19	73301+13	71304SLK+50	71304K-50	A520MR2-G 116L	520	116
125	SX 125	20-22	73301+13	71304SLK+51	71304K-51	A520MR2-G 116L	520	116
125	XC 125	21-21	73301+13	71304SLK+51	71304K-51	A520MR2-G 116L	520	116
125	XC-W 125	17-19	73301+13	71304SLK+50	71304K-50	A520XRR3-G 116L	520	116
144	SX 144	08-08	73301+14	71304SLK+50	71304K-50	A520MR2-G 116L	520	116
150	EXC 150 TPI	20-22	73301+13	71304SLK+50	71304K-50	A520XRR3-G 116L	520	116
150	SX 150	09-11	73301+14	71304SLK+50	71304K-50	A520MR2-G 116L	520	116
150	SX 150	12-22	73301+13	71304SLK+48	71304K-48	A520MR2-G 114L	520	114
150	XC 150	11-15	73301+13	71304SLK+50	71304K-50	A520MR2-G 116L	520	116
150	XC-W 150	17-21	73301+13	71304SLK+50	71304K-50	A520MR2-G 116L	520	116
200	EXC 200	98-11	73301+14	71304SLK+48	71304K-48	A520XRR3-G 114L	520	114
200	EXC-GS 200	00-02	73301+14	71304SLK+48	71304K-48	A520XRR3-G 114L	520	114
200	MXC 200	98-98	73301+14	71304SLK+50	71304K-50	A520MR2-G 116L	520	116
200	MXC 200	99-04	73301+14	71304SLK+48	71304K-48	A520MR2-G 114L	520	114
200	SX 200	04-04	73301+14	71304SLK+48	71304K-48	A520MR2-G 114L	520	114
250	EGS 250	94-94	73301+14	71304SLK+50	71304K-50	A520XRR3-G 114L	520	114
250	EGS 250	95-95	73301+12	71304SLK+50	71304K-50	A520XRR3-G 114L	520	114
250	EGS 250	96-97	73301+13	71304SLK+50	71304K-50	A520XRR3-G 114L	520	114
250	EGS 250	98-99	73301+14	71304SLK+50	71304K-50	A520XRR3-G 114L	520	114
250	EXC 250	96-97	73301+13	71304SLK+50	71304K-50	A520XRR3-G 114L	520	114
250	EXC 250	98-98	73301+13	71304SLK+48	71304K-48	A520XRR3-G 114L	520	114
250	EXC 250	99-03	73301+14	71304SLK+50	71304K-50	A520XRR3-G 114L	520	114
250	EXC 250	04-04	73301+14	71304SLK+48	71304K-48	A520XRR3-G 114L	520	114
250	EXC 250	05-17	73301+13	71304SLK+50	71304K-50	A520XRR3-G 116L	520	116
250	EXC 250 E-Starter	10-10	73301+13	71304SLK+50	71304K-50	A520XRR3-G 116L	520	116
250	EXC 250 Factory	05-05	73301+13	71304SLK+50	71304K-50	A520XRR3-G 116L	520	116
250	EXC 250 Factory Edition	11-11	73301+13	71304SLK+50	71304K-50	A520XRR3-G 116L	520	116
250	EXC 250 Racing	01-03	73301+14	71304SLK+50	71304K-50	A520XRR3-G 114L	520	114
250	EXC 250 Racing	04-04	73301+14	71304SLK+48	71304K-48	A520XRR3-G 114L	520	114
250	EXC 250 Racing	05-06	73301+13	71304SLK+50	71304K-50	A520XRR3-G 116L	520	116
250	EXC 250 Racing Six Days	02-03	73301+14	71304SLK+50	71304K-50	A520XRR3-G 114L	520	114
250	EXC 250 Six Days	01-03	73301+14	71304SLK+50	71304K-50	A520XRR3-G 114L	520	114
250	EXC 250 Six Days	04-04	73301+14	71304SLK+48	71304K-48	A520XRR3-G 114L	520	114
250	EXC 250 Six Days	05-16	73301+13	71304SLK+50	71304K-50	A520XRR3-G 116L	520	116
250	EXC 250 TPI	18-21	73301+13	71304SLK+50	71304K-50	A520XRR3-G 116L	520	116
250	EXC 250 TPI	22-22	73301+13	71304SLK+52	71304K-52	A520XRR3-G 116L	520	116
250	EXC 250 TPI Six Days	18-21	73301+13	71304SLK+50	71304K-50	A520XRR3-G 116L	520	116
250	EXC 250 TPI Six Days	22-22	73301+13	71304SLK+52	71304K-52	A520XRR3-G 116L	520	116
250	EXC-F 250	06-09	73301+13	71304SLK+52	71304K-52	A520XRR3-G 116L	520	116
250	EXC-F 250	10-14	73301+13	71304SLK+50	71304K-50	A520XRR3-G 116L	520	116
250	EXC-F 250	15-22	73301+13	71304SLK+52	71304K-52	A520XRR3-G 118L	520	118
250	EXC-F 250 Champion Edition	10-10	73301+13	71304SLK+50	71304K-50	A520XRR3-G 116L	520	116
250	EXC-F 250 EXC Racing	02-06	73301+13	71304SLK+52	71304K-52	A520XRR3-G 116L	520	116
250	EXC-F 250 Factory Edition	11-11	73301+13	71304SLK+50	71304K-50	A520XRR3-G 116L	520	116
250	EXC-F 250 Factory Edition	15-15	73301+13	71304SLK+52	71304K-52	A520XRR3-G 118L	520	118
250	EXC-F 250 Six Days	07-09	73301+13	71304SLK+52	71304K-52	A520XRR3-G 116L	520	116
250	EXC-F 250 Six Days	10-14	73301+13	71304SLK+50	71304K-50	A520XRR3-G 116L	520	116
250	EXC-F 250 Six Days	15-22	73301+13	71304SLK+52	71304K-52	A520XRR3-G 118L	520	118

TRANSMISSION

Cyl.	Modèle	Année	Pignon	Couronne SLK	Couronne HDK	Chaîne	Pas	Longueur
KTM								
250	GS 250	92-93	73301+13	71304SLK+48	71304K-48	A520XRR3-G 114L	520	114
250	SX 250	94-94	73301+14	71304SLK+50	71304K-50	A520MR2-G 114L	520	114
250	SX 250	95-98	73301+13	71304SLK+50	71304K-50	A520MR2-G 114L	520	114
250	SX 250	99-03	73301+14	71304SLK+50	71304K-50	A520MR2-G 114L	520	114
250	SX 250	04-04	73301+13	71304SLK+50	71304K-50	A520MX6-GG 114L	520	114
250	SX 250	05-16	73301+13	71304SLK+48	71304K-48	A520MX6-GG 114L	520	114
250	SX 250	17-20	73301+14	71304SLK+50	71304K-50	A520MX6-GG 116L	520	116
250	SX-F 250	06-12	73301+13	71304SLK+48	71304K-48	A520MX6-GG 114L	520	114
250	SX-F 250	13-16	73301+13	71304SLK+50	71304K-50	A520MX6-GG 116L	520	116
250	SX-F 250	17-22	73301+14	71304SLK+51	71304K-51	A520MX6-GG 118L	520	118
250	XC 250	11-14	73301+14	71304SLK+50	71304K-50	A520MX6-GG 116L	520	116
250	XC 250	15-17	73301+13	71304SLK+50	71304K-50	A520MX6-GG 116L	520	116
250	XC 250 TPI	18-19	73301+13	71304SLK+50	71304K-50	A520MX6-GG 116L	520	116
250	XC 250 TPI	20-21	73301+13	71304SLK+51	71304K-51	A520MX6-GG 116L	520	116
250	XC-F 250	11-11	73301+13	71304SLK+48	71304K-48	A520MX6-GG 114L	520	114
250	XC-F 250	12-19	73301+13	71304SLK+50	71304K-50	A520MX6-GG 116L	520	116
250	XC-F 250 .	20-21	73301+13	71304SLK+51	71304K-51	A520MX6-GG 116L	520	116
300	EGS 300	96-99	73301+14	71304SLK+48	71304K-48	A520XRR3-G 116L	520	116
300	E-GS 300	94-95	73301+14	71304SLK+48	71304K-48	A520XRR3-G 116L	520	116
300	EXC 300	96-97	73301+14	71304SLK+50	71304K-50	A520XRR3-G 114L	520	114
300	EXC 300	99-05	73301+14	71304SLK+50	71304K-50	A520XRR3-G 114L	520	114
300	EXC 300	06-17	73301+13	71304SLK+50	71304K-50	A520XRR3-G 116L	520	116
300	E-XC 300	94-95	73301+14	71304SLK+50	71304K-50	A520XRR3-G 114L	520	114
300	EXC 300 Factory Edition	11-11	73301+13	71304SLK+50	71304K-50	A520XRR3-G 116L	520	116
300	EXC 300 Six Days	01-05	73301+14	71304SLK+50	71304K-50	A520XRR3-G 114L	520	114
300	EXC 300 Six Days	06-16	73301+13	71304SLK+50	71304K-50	A520XRR3-G 116L	520	116
300	EXC 300 TPI	18-22	73301+13	71304SLK+50	71304K-50	A520XRR3-G 116L	520	116
300	EXC 300 TPI Erzbergrodeo	20-21	73301+12	71304SLK+50	71304K-50	A520XRR3-G 116L	520	116
300	EXC 300 TPI Six Days	18-22	73301+13	71304SLK+50	71304K-50	A520XRR3-G 116L	520	116
300	EXC-E 300	07-07	73301+14	71304SLK+50	71304K-50	A520XRR3-G 116L	520	116
300	EXC-E 300 Six Days	08-08	73301+14	71304SLK+50	71304K-50	A520XRR3-G 116L	520	116
300	EXC-E 300 Six Days	10-11	73301+13	71304SLK+50	71304K-50	A520XRR3-G 116L	520	116
300	GS 300	90-93	73301+14	71304SLK+48	71304K-48	A520XRR3-G 116L	520	116
300	GS 300	94-94	73301+14	71304SLK+50	71304K-50	A520XRR3-G 114L	520	114
300	GS 300	95-98	73301+13	71304SLK+50	71304K-50	A520XRR3-G 114L	520	114
300	GS 300	99-99	73301+14	71304SLK+50	71304K-50	A520XRR3-G 114L	520	114
300	SX 300	93-93	73301+14	71304SLK+50	71304K-50	A520MX6-GG 116L	520	116
300	SX 300	94-94	73301+14	71304SLK+50	71304K-50	A520MX6-GG 114L	520	114
300	SX 300	95-04	73301+13	71304SLK+50	71304K-50	A520MX6-GG 114L	520	114
300	XC 300 2T	11-14	73301+14	71304SLK+50	71304K-50	A520MX6-GG 116L	520	116
300	XC 300 2T	15-17	73301+13	71304SLK+50	71304K-50	A520MX6-GG 116L	520	116
300	XC 300 TPI 2T	18-19	73301+13	71304SLK+50	71304K-50	A520MX6-GG 116L	520	116
300	XC 300 TPI 2T	20-21	73301+13	71304SLK+51	71304K-51	A520MX6-GG 116L	520	116
350	EXC-F 350	11-22	73301+13	71304SLK+52	71304K-52	A520XRR3-G 116L	520	116
350	EXC-F 350 Six Days	12-22	73301+13	71304SLK+52	71304K-52	A520XRR3-G 116L	520	116
350	GS 350	86-86	73301+13	71304SLK+52	71304K-52	A520XRR3-G 116L	520	116
350	SX-F 350	10-19	73301+14	71304SLK+50	71304K-50	A520MX6-GG 116L	520	116
350	SX-F 350	20-22	73301+14	71304SLK+51	71304K-51	A520MX6-GG 118L	520	118
350	XC-F 350	12-12	73301+14	71304SLK+50	71304K-50	A520MX6-GG 116L	520	116



Cyl.	Modèle	Année	Pignon	Couronne SLK	Couronne HDK	Chaîne	Pas	Longueur
350	XC-F 350	13-15	73301+13	71304SLK+50	71304K-50	A520MX6-GG 116L	520	116
350	XC-F 350	16-19	73301+14	71304SLK+50	71304K-50	A520MX6-GG 116L	520	116
350	XC-F 350	20-21	73301+14	71304SLK+51	71304K-51	A520MX6-GG 118L	520	118
360	EXC 360	96-97	73301+13	71304SLK+50	71304K-50	A520XRR3-G 114L	520	114
360	SX 360	96-98	73301+13	71304SLK+50	71304K-50	A520MX6-GG 114L	520	114
380	EXC 380	98-03	73301+14	71304SLK+50	71304K-50	A520XRR3-G 114L	520	114
380	SX 380	98-03	73301+14	71304SLK+50	71304K-50	A520MX6-GG 114L	520	114
400	EXC 400	09-11	73301+13	71304SLK+52	71304K-52	A520XRR3-G 116L	520	116
400	EXC 400 Factory Edition	11-11	73301+13	71304SLK+52	71304K-52	A520XRR3-G 116L	520	116
400	EXC 400 Factory Racing	05-07	73301+14	71304SLK+50	71304K-50	A520XRR3-G 114L	520	114
400	EXC 400 Racing	00-07	73301+14	71304SLK+50	71304K-50	A520XRR3-G 114L	520	114
400	EXC 400 Racing Six Days	01-03	73301+14	71304SLK+50	71304K-50	A520XRR3-G 114L	520	114
400	SX 400	00-02	73301+14	71304SLK+50	71304K-50	A520MX6-GG 114L	520	114
440	SX 440	94-95	73301+14	71304SLK+50	71304K-50	A520MX6-GG 114L	520	114
450	EXC 450	06-06	73301+14	71304SLK+50	71304K-50	A520XRR3-G 116L	520	116
450	EXC 450	09-16	73301+13	71304SLK+52	71304K-52	A520XRR3-G 116L	520	116
450	EXC 450 Champion Edition	10-10	73301+13	71304SLK+52	71304K-52	A520XRR3-G 116L	520	116
450	EXC 450 Factory	05-05	73301+14	71304SLK+50	71304K-50	A520XRR3-G 116L	520	116
450	EXC 450 Factory Racing	07-07	73301+14	71304SLK+50	71304K-50	A520XRR3-G 116L	520	116
450	EXC 450 Racing	03-07	73301+14	71304SLK+50	71304K-50	A520XRR3-G 116L	520	116
450	EXC 450 Racing Six Days	04-07	73301+14	71304SLK+50	71304K-50	A520XRR3-G 116L	520	116
450	EXC 450 Six Days	09-16	73301+13	71304SLK+52	71304K-52	A520XRR3-G 116L	520	116
450	EXC-F 450	17-22	73301+13	71304SLK+52	71304K-52	A520XRR3-G 116L	520	116
450	EXC-F 450 Six Days	17-22	73301+13	71304SLK+52	71304K-52	A520XRR3-G 116L	520	116
450	EXC-R 450	08-08	73301+14	71304SLK+52	71304K-52	A520XRR3-G 116L	520	116
450	EXC-R 450 Six Days	08-08	73301+14	71304SLK+52	71304K-52	A520XRR3-G 116L	520	116
450	SX-F 450	03-03	73301+14	71304SLK+50	71304K-50	A520MX6-GG 114L	520	114
450	SX-F 450	04-13	73301+14	71304SLK+52	71304K-52	A520MX6-GG 118L	520	118
450	SX-F 450	14-15	73301+14	71304SLK+50	71304K-50	A520MX6-GG 116L	520	116
450	SX-F 450	16-19	73301+13	71304SLK+48	71304K-48	A520MX6-GG 114L	520	114
450	SX-F 450	20-22	73301+13	71304SLK+49	71304K-49	A520MX6-GG 116L	520	116
450	SX-F 450 Cairoli	20-20	73301+13	71304SLK+49	71304K-49	A520MX6-GG 116L	520	116
450	SX-F 450 Factory Edition	20-20	73301+13	71304SLK+49	71304K-49	A520MX6-GG 116L	520	116
450	SX-F 450 Herlings Replica	19-19	73301+13	71304SLK+48	71304K-48	A520MX6-GG 114L	520	114
450	XC-F 450	08-09	73301+14	71304SLK+52	71304K-52	A520MX6-GG 118L	520	118
450	XC-F 450	13-15	73301+14	71304SLK+50	71304K-50	A520MX6-GG 116L	520	116
450	XC-F 450	16-21	73301+13	71304SLK+50	71304K-50	A520MX6-GG 116L	520	116
500	EXC 500	12-16	73301+13	71304SLK+50	71304K-50	A520XRR3-G 116L	520	116
500	EXC 500 Six Days	12-16	73301+13	71304SLK+50	71304K-50	A520XRR3-G 116L	520	116
500	EXC-F 500	17-22	73301+13	71304SLK+50	71304K-50	A520XRR3-G 116L	520	116
500	EXC-F 500 Six Days	17-22	73301+13	71304SLK+50	71304K-50	A520XRR3-G 116L	520	116
500	SX 500	95-98	73301+14	71304SLK+50	71304K-50	A520MX6-GG 114L	520	114
505	SX-F 505	07-09	73301+14	71304SLK+52	71304K-52	A520MX6-GG 116L	520	116
505	XC-F 505	09-09	73301+14	71304SLK+52	71304K-52	A520MX6-GG 116L	520	116
520	EXC 520 Racing	00-00	73301+14	71304SLK+50	71304K-50	A520XRR3-G 114L	520	114
520	EXC 520 Racing	01-02	73301+14	71304SLK+48	71304K-48	A520XRR3-G 114L	520	114
520	EXC 520 Racing Six Days	01-02	73301+14	71304SLK+48	71304K-48	A520XRR3-G 114L	520	114
520	EXC-E 520	99-99	73301+14	71304SLK+50	71304K-50	A520XRR3-G 114L	520	114
520	SX 520 Racing	00-00	73301+14	71304SLK+50	71304K-50	A520MX6-GG 114L	520	114
520	SX 520 Racing	01-03	73301+14	71304SLK+48	71304K-48	A520MX6-GG 114L	520	114

TRANSMISSION

Cyl.	Modèle	Année	Pignon	Couronne SLK	Couronne HDK	Chaîne	Pas	Longueur
KTM								
525	EXC 525 Factory	05-05	73301+14	71304SLK+48	71304K-48	A520XRR3-G 114L	520	114
525	EXC 525 Factory Racing	07-07	73301+14	71304SLK+48	71304K-48	A520XRR3-G 114L	520	114
525	EXC 525 Racing	03-07	73301+14	71304SLK+48	71304K-48	A520XRR3-G 114L	520	114
525	EXC 525 Racing Six Days	03-07	73301+14	71304SLK+48	71304K-48	A520XRR3-G 114L	520	114
525	SX 525	03-06	73301+14	71304SLK+48	71304K-48	A520MX6-GG 114L	520	114
530	EXC 530	09-11	73301+14	71304SLK+52	71304K-52	A520XRR3-G 116L	520	116
530	EXC 530 Factory Edition	11-11	73301+14	71304SLK+52	71304K-52	A520XRR3-G 116L	520	116
530	EXC 530 Six Days	09-11	73301+14	71304SLK+52	71304K-52	A520XRR3-G 116L	520	116
530	EXC 530 Six Days	12-12	73301+14	71304SLK+52	71304K-52	A520XRR3-G 116L	520	116
530	EXC-R 530	08-08	73301+14	71304SLK+50	71304K-50	A520XRR3-G 116L	520	116
530	EXC-R 530 Six Days	08-08	73301+14	71304SLK+50	71304K-50	A520XRR3-G 116L	520	116
SHERCO								
125	SE 125 Enduro Factory	18-22	43303-13	14206SLK+51	14206K-51	A520XRR3-G 114L	520	114
125	SE 125 Enduro Racing	18-18	43303-13	14206SLK+51	14206K-51	A520XRR3-G 114L	520	114
125	SE 125 Enduro Racing	19-21	43303-13	14206SLK+51	14206K-51	A520XRR3-G 114L	520	114
250	2,5 i-F Enduro 2.5i	08-08		14206SLK+48	14206K-48	A520XRR3-G 112L	520	112
250	SC 250 Cross Country	19-20	43304-14	14206SLK+49	10206K-49	A520XRR3-G 114L	520	114
250	SCF 250 Cross Country	19-20	43303-13	14206SLK+49	10206K-49	A520XRR3-G 114L	520	114
250	SE 2,5 i-F Enduro 2.5i	09-11		14206SLK+48	14206K-48	A520XRR3-G 112L	520	112
250	SE 250 Enduro	14-18	43304-14	14206SLK+49	10206K-49	A520XRR3-G 114L	520	114
250	SE 250 Enduro Factory	17-20	43304-14	14206SLK+49	10206K-49	A520XRR3-G 114L	520	114
250	SE 250 Enduro Factory	21-22	43305-13	14206SLK+50	14206K-50	A520XRR3-G 114L	520	114
250	SE 250 Enduro Racing	14-20	43304-14	14206SLK+49	10206K-49	A520XRR3-G 114L	520	114
250	SE 250 Enduro Racing	21-22	43305-13	14206SLK+50	14206K-50	A520XRR3-G 114L	520	114
250	SE 250 i-F Enduro	12-13	43303-13	14206SLK+48	14206K-48	A520XRR3-G 112L	520	112
250	SEF 250 Enduro	14-18	43303-13	14206SLK+49	10206K-49	A520XRR3-G 114L	520	114
250	SEF 250 Enduro Factory	17-20	43303-13	14206SLK+49	10206K-49	A520XRR3-G 114L	520	114
250	SEF 250 Enduro Factory	21-22	43305-13	14206SLK+49	10206K-49	A520XRR3-G 114L	520	114
250	SEF 250 Enduro Racing	14-20	43303-13	14206SLK+49	10206K-49	A520XRR3-G 114L	520	114
250	SEF 250 Enduro Racing	21-21	43305-13	14206SLK+49	10206K-49	A520XRR3-G 114L	520	114
300	SC 300 Cross Country	19-20	43304-14	14206SLK+49	10206K-49	A520XRR3-G 114L	520	114
300	SCF 300 Cross Country	19-20	43303-13	14206SLK+48	14206K-48	A520XRR3-G 114L	520	114
300	SE 3 i-F Enduro SE 3.0i	10-11		14206SLK+48	14206K-48	A520XRR3-G 112L	520	112
300	SE 300 Enduro	14-18	43304-14	14206SLK+49	10206K-49	A520XRR3-G 114L	520	114
300	SE 300 Enduro Factory	17-20	43304-14	14206SLK+49	10206K-49	A520XRR3-G 114L	520	114
300	SE 300 Enduro Factory	21-22	43305-13	14206SLK+48	14206K-48	A520XRR3-G 114L	520	114
300	SE 300 Enduro Racing	14-20	43304-14	14206SLK+49	10206K-49	A520XRR3-G 114L	520	114
300	SE 300 Enduro Racing	21-22	43305-13	14206SLK+48	14206K-48	A520XRR3-G 114L	520	114
300	SE 300 i-F Enduro	12-12	43303-13	14206SLK+48	14206K-48	A520XRR3-G 112L	520	112
300	SE 300 i-F Enduro	13-13	43303-13	14206SLK+49	10206K-49	A520XRR3-G 114L	520	114
300	SEF 300 Enduro	14-15	43303-13	14206SLK+49	10206K-49	A520XRR3-G 114L	520	114
300	SEF 300 Enduro	16-18	43303-13	14206SLK+48	14206K-48	A520XRR3-G 114L	520	114
300	SEF 300 Enduro Factory	17-20	43303-13	14206SLK+48	14206K-48	A520XRR3-G 114L	520	114
300	SEF 300 Enduro Factory	21-22	43305-13	14206SLK+48	14206K-48	A520XRR3-G 114L	520	114
300	SEF 300 Enduro Racing	14-20	43303-13	14206SLK+48	14206K-48	A520XRR3-G 114L	520	114
300	SEF 300 Enduro Racing	21-22	43305-13	14206SLK+48	14206K-48	A520XRR3-G 114L	520	114
450	4,5 i Enduro 4.5i	04-08		14206SLK+48	14206K-48	A520XRR3-G 112L	520	112
450	SCF 450 Cross Country	19-20	43304-14	14206SLK+50	14206K-50	A520XRR3-G 114L	520	114
450	SE 4,5 i-F Enduro 4.5i	09-11		14206SLK+48	14206K-48	A520XRR3-G 112L	520	112



Cyl.	Modèle	Année	Pignon	Couronne SLK	Couronne HDK	Chaîne	Pas	Longueur
450	SE 450 i-R Enduro 4.5i	12-12		14206SLK+48	14206K-48	A520XRR3-G 112L	520	112
450	SE 450 i-R Enduro 4.5i	13-13		14206SLK+48	14206K-48	A520XRR3-G 112L	520	112
450	SEF 450	15-18	43304-14	14206SLK+50	14206K-50	A520XRR3-G 114L	520	114
450	SEF 450 Enduro Factory	17-22	43304-14	14206SLK+50	14206K-50	A520XRR3-G 114L	520	114
450	SEF 450 Enduro Racing	15-21	43304-14	14206SLK+50	14206K-50	A520XRR3-G 114L	520	114
500	SCF 500 Cross Country	19-20	43304-14	14206SLK+50	14206K-50	A520XRR3-G 114L	520	114
500	SEF 500 Enduro Racing	19-21	43304-14	14206SLK+50	14206K-50	A520XRR3-G 114L	520	114
510	5,1 i Enduro 5.1i	06-08		14206SLK+48	14206K-48	A520XRR3-G 112L	520	112
510	SE 5,1 i-F Enduro 5.1iF	09-11		14206SLK+48	14206K-48	A520XRR3-G 112L	520	112
SUZUKI								
250	DR 250 L,M,N,P	90-93	22303+13	14203SLK+50	14203K-50		520	110
250	DR 250 S L,M,N	90-92	22303+13	14206SLK+50	14206K-50	A520XRR3-G 114L	520	114
250	DR-Z 250 K1,K2,K3,K4,K5,K6,K7	01-07	22303+13	14203SLK+50	14203K-50	A520XRR3-G 112L	520	112
250	RM 250 P	93-93	22303+13	14203SLK+49	14203K-49	A520MR2-G 116L	520	116
250	RM 250 R,S,T	94-96	22303+13	14203SLK+49	14203K-49	A520MR2-G 112L	520	112
250	RM 250 V,W	97-98	22303+13	14203SLK+50	14203K-50	A520MR2-G 114L	520	114
250	RM 250 X,Y	99-00	22303+13	14203SLK+48	14203K-48	A520MR2-G 112L	520	112
250	RM 250 K1,K2,K3	01-03	22303+13	14203SLK+49	14203K-49	A520MR2-G 112L	520	112
250	RM 250 K4,K5,K6,K7,K8,K9	04-09	22303+13	14203SLK+50	14203K-50	A520MX6-GG 114L	520	114
250	RM-Z 250 K4,K5,K6	04-06	24304+13	16206SLK+48	16206K-48	A520MX6-GG 114L	520	114
250	RM-Z 250 L3,L4,L5	13-15	22311+13	14203SLK+49	14203K-49	A520MX6-GG 114L	520	114
250	RM-Z 250 L6,L7,L8	16-18	22311+13	14203SLK+49	14203K-49	A520MX6-GG 114L	520	114
250	RM-Z 250 L9,M0,M1,M2	19-22	22311+13	14203SLK+50	14203K-50	A520MX6-GG 114L	520	114
350	DR 350 USA L,M,N,P	90-93	22303+14	14203SLK+47	14203K-47		520	110
400	DR-Z 400 Y,K1,K2,K3,K4,K5,K6,K7	00-07	22303+14	14203SLK+47	14203K-47	A520XRR3-G 112L	520	112
450	RM-X 450 Z L0,L1,L2,L3,L4,L5,L6,L7	10-17	22406+13	14203SLK+51	14203K-51	A520XRR3-G 114L	520	114
450	RM-Z 450 K5,K6,K7	05-07	22406+14	14203SLK+49	14203K-49	A520MX6-GG 116L	520	116
450	RM-Z 450 K8,K9,L0,L1,L2,L3,L4	08-14	22406+13	14203SLK+50	14203K-50	A520MX6-GG 114L	520	114
450	RM-Z 450 L5,L6,L7,L8,L9,M0,M1,M2	15-22	22408+13	14203SLK+50	14203K-50	A520MX6-GG 114L	520	114
YAMAHA								
125	WR 125 L,M,N	99-01	21203+13	12323SLK+48	12323K-48	A520XRR3-G 112L	520	112
125	WR 125 P,K	02-03	21203+13	12323SLK+49	12323K-49	A520XRR3-G 112L	520	112
125	YZ 125 L,M,N	99-01	21203+13	12323SLK+48	12323K-48	A520MR2-G 112L	520	112
125	YZ 125 P,R,S	02-04	21203+13	12323SLK+49	12323K-49	A520MR2-G 112L	520	112
125	YZ 125 T,V,W,X,Y,Z,A,B,D,E,F,G,H,J,K,L,M	05-21	21309-13	12323SLK+48	12323K-48	A520MR2-G 112L	520	112
125	YZ 125 N	22-22	21309-13	12323SLK+49	12323K-49	A520MR2-G 112L	520	112
250	WR 250 F N,P,R,S,T,V	01-06	21309-13	12323SLK+51	12323K-51	A520XRR3-G 114L	520	114
250	WR 250 F W,X,Y,Z,A,B,D,E,F,G,H,J,K	07-19	21309-13	12323SLK+50	12323K-50	A520XRR3-G 114L	520	114
250	WR 250 F	20-22	21309-13	12323SLK+51	12323K-51	A520XRR3-G 114L	520	114
250	WR 250 Z	00-01	27500+14	12323SLK+50	12323K-50	A520XRR3-G 114L	520	114
250	WR 250 Z	02-02	27500+14	12323SLK+49	12323K-49	A520XRR3-G 114L	520	114
250	WR 250 Z	03-03	27500+14	12323SLK+48	12323K-48	A520XRR3-G 114L	520	114
250	YZ 250 L,M,N	99-01	27500+14	12323SLK+50	12323K-50	A520MR2-G 114L	520	114
250	YZ 250 P,R,S,T	02-05	27500+14	12323SLK+49	12323K-49	A520MR2-G 114L	520	114
250	YZ 250 V,W,X,Y,Z	06-10	27500+14	12323SLK+50	12323K-50	A520MX6-GG 114L	520	114
250	YZ 250 A,B,D,E,F,G,H,J,K,L,M,N	11-22	27500+14	12323SLK+50	12323K-50	A520MX6-GG 114L	520	114
250	YZ 250 A,B,D,E,F,G,H,J,K,L,M,N	11-22	27500+14	12323SLK+50	12323K-50	A520MX6-GG 114L	520	114
250	YZ 250 F N,P,R,S	01-04	21309-13	12323SLK+48	12323K-48	A520MX6-GG 114L	520	114
250	YZ 250 F T,V,W,X	05-08	21309-13	12323SLK+49	12323K-49	A520MX6-GG 112L	520	112
250	YZ 250 F Y,Z,A,B,D	09-13	21309-13	12323SLK+51	12323K-51	A520MX6-GG 114L	520	114

Cyl.	Modèle	Année	Pignon	Couronne SLK	Couronne HDK	Chaîne	Pas	Longueur
YAMAHA								
250	YZ 250 F E,F,G,H,J,K,L,M,N	14-22	21309-13	12323SLK+50	12323K-50	A520MX6-GG 114L	520	114
250	YZ 250 X G,H,J,K,L	16-20	27500+14	12323SLK+50	12323K-50	A520XRR3-G 114L	520	114
400	WR 400 F L	99-99	27500+14	12323SLK+50	12323K-50	A520XRR3-G 114L	520	114
400	YZ 400 F L	99-99	27500+14	12323SLK+49	12323K-49	A520MX6-GG 114L	520	114
426	WR 426 F M,N,P	00-02	27500+14	12323SLK+50	12323K-50	A520XRR3-G 114L	520	114
426	YZ 426 F M,N,P	00-02	27500+14	12323SLK+48	12323K-48	A520MX6-GG 112L	520	112
450	WR 450 F R,S,T,V	03-06	27500+14	12323SLK+50	12323K-50	A520XRR3-G 114L	520	114
450	WR 450 F W,X,Y,Z,A,B,D,E,F,G,H,J,K,L,M,N	07-22	27500+13	12323SLK+50	12323K-50	A520XRR3-G 114L	520	114
450	YZ 450 F R,S	03-04	27500+14	12323SLK+47	12323K-47	A520MX6-GG 112L	520	112
450	YZ 450 F T	05-05	27500+14	12323SLK+51	12323K-51	A520MX6-GG 116L	520	116
450	YZ 450 F V,X,Y,Z,A,B,D,E	06-14	27500+13	12323SLK+49	12323K-49	A520MX6-GG 114L	520	114
450	YZ 450 F F,G,H,J,K	15-19	27500+13	12323SLK+48	12323K-48	A520MX6-GG 114L	520	114
450	YZ 450 F L,M,N	20-22	27500+13	12323SLK+49	12323K-49	A520MX6-GG 114L	520	114
450	YZ 450 FX G,H,J,K,L	16-20	27500+13	12323SLK+50	12323K-50	A520XRR3-G 114L	520	114







Spécialiste freinage

Leader du marché mondial

SBS a été la première entreprise à fabriquer des plaquettes de frein pour le marché de la deuxième monte pour motos.

Depuis 50 ans, SBS développe de nouveaux produits avec, toujours à l'esprit : la performance, la sécurité, le confort, la durée de vie et la protection de l'environnement.

Les disques SBS

Matériaux et technologies de pointe pour nos disques haute performance : longévité et confort d'utilisation sans faille.

Testés en conditions réelles, par tous types de temps. Tests dynamométriques, mais aussi sur tous types de courses et de sols avec la participation des plus grands champions.

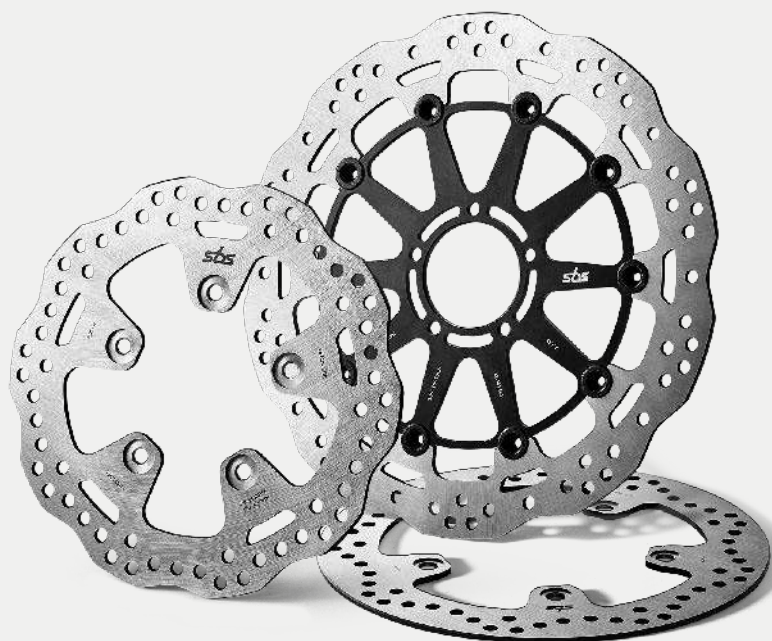

FREINAGE

PLAQUETTES /
DISQUES /

sbs
GO AHEAD

BRAKING

GUIDE
D'APPLICATION



316

SBS

372

BRAKING

373

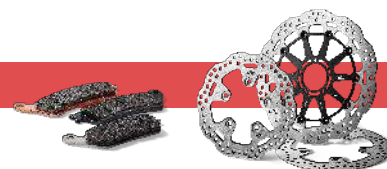

Cyl.	Modèle	Années	sbs		sbs		sbs		sbs	
			PLAQUETTES AV	€ T.T.C.	PLAQUETTES AR	€ T.T.C.	DISQUE AV	€ T.T.C.	DISQUE AR	€ T.T.C.
ADLY										
50	RS XXL SuperSonic 50	05-10	102HF	20,10€	102HF	20,10€				
300	ATV-Crossover Boost 300	07-12	810ATS	28,40€	544ATS	28,40€				
300	Hurricane 300	07-12	810ATS	28,40€						
300	Interceptor 300	07-12	810ATS	28,40€						
300	Sentinel 300	07-12	810ATS	28,40€						
320	Canyon 320	07-12	810ATS	28,40€						
320	Hurricane 320	07-12	810ATS	28,40€						
AEON										
100	Revo 100	04-10			544ATS	28,40€				
125	Overland 125	02-09			638ATS	28,40€				
180	Cobra 180 RS	02-03			638ATS	28,40€				
180	Cobra 180 RS II	04-08			638ATS	28,40€				
180	Overland 180	02-10			638ATS	28,40€				
APRILIA										
240	Climber (trial)	89-89	607HF	22,60€	574HF	22,60€				
275	Climber (trial)	89-89	607HF	22,60€	574HF	22,60€				
280	Climber R(trial)	92-92	559RSI	39,80€	559RSI	39,80€				
350	Tuareg	86-86	588HF	22,60€	519HF	22,60€				
350	Tuareg	89-89	641HF	30,90€	519HF	22,60€				
450	MXV450	09-14	694SI	28,40€	777SI	28,40€				
450	RXV450	06-14	694SI	28,40€	790SI	28,40€				
450	SXV450	06-14	842RSI	39,90€	790SI	28,40€				
550	RXV550	06-14	694SI	28,40€	790SI	28,40€				
550	SXV550	06-14	842RSI	39,90€	790SI	28,40€				
ARCTIC CAT										
50	2WD 50	04-05	02048	28,20€						
50	DVX50	06-11	02048	28,20€	638ATS	28,40€				
90	2WD 90	02-05	02048	28,20€	638ATS	28,40€				
90	DVX90	06-11	02048	28,20€	638ATS	28,40€				
250	Cat 2x4 250	99-04	758ATS	28,40€	758ATS	28,40€				
250	Cat 2x4 250	05-11	822ATS	28,40€	827ATS	28,40€				
250	Cat 4x4 250	00-04	758ATS	28,40€	827ATS	28,40€				
250	DVX250	06-08	822ATS	28,40€	822ATS	28,40€				
300	Cat 2x4 300	98-03	758ATS	28,40€	827ATS	28,40€				
300	Cat 2x4 300	04-04	758ATS	28,40€	758ATS	28,40€				
300	Cat 4x4 300	05-11	822ATS	28,40€	822ATS	28,40€				
400	Cat 2x4 400	98-04	758ATS	28,40€	758ATS	28,40€				
400	Cat 2x4 400	05-08	822ATS	28,40€	822ATS	28,40€				
400	Cat 4x4 400	98-04	758ATS	28,40€	758ATS	28,40€				
400	Cat 4x4 400	05-05	822ATS	28,40€	822ATS	28,40€				
400	DVX400	04-08	592ATS 649ATS	28,40€ 28,40€	649ATS	28,40€				
400	TBX 4x4 400	04-05	758ATS	28,40€	827ATS	28,40€				
500	Cat 2x4 500	98-04	758ATS	28,40€	758ATS	28,40€				
500	Cat 4x4 500	98-03	758ATS	28,40€	827ATS	28,40€				
500	Cat 4x4 500	04-04	758ATS	28,40€	758ATS	28,40€				
500	Cat 4x4 500	05-10	822ATS	28,40€	822ATS	28,40€				
500	TBX 4x4 500	02-04	758ATS	28,40€	827ATS	28,40€				
500	TBX 4x4 500	05-10	822ATS	28,40€	827ATS	28,40€				
500	TRV 4x4 500	03-04	758ATS	28,40€	827ATS	28,40€				
500	TRV 4x4 500	05-11	822ATS	28,40€	822ATS	28,40€				
650	Cat 4x4 650 H1	05-11	822ATS	28,40€	822ATS	28,40€				
650	Cat 4x4 650 V2 /LE	05-11	822ATS	28,40€	822ATS	28,40€				
650	Prowler XT 650 4x4 H1	06-11	822ATS	28,40€	822ATS	28,40€				
700	Cat 4x4 700	07-11	822ATS	28,40€	822ATS	28,40€				
700	Wild Cat 700	16-17	946ATS	28,40€	822ATS	28,40€				
1000	Wild Cat 1000	16-17	912SI	28,40€	822ATS	28,40€				
BENELLI										
449	BX449 Cross	07-11	671SI	28,40€	675SI	28,40€				
505	BX505 Enduro	08-08	671SI	28,40€	675SI	28,40€				
570	BX570 Motard	08-12			675SI	28,40€				

BRAKING

Années	BRAKING		BRAKING		BRAKING		BRAKING		BRAKING	
	DISQUE AV WAVE	€ T.T.C.	DISQUE AR WAVE	€ T.T.C.	DISQUE AV ROND	€ T.T.C.	DISQUE AR ROND	€ T.T.C.	DISQUE 270mm OVERSIZE	€ T.T.C.
ADLY										
50	RS XXL SuperSonic 50	05-10								
300	ATV-Crossover Boost 300	07-12								
300	Hurricane 300	07-12								
300	Interceptor 300	07-12								
300	Sentinel 300	07-12								
320	Canyon 320	07-12								
320	Hurricane 320	07-12								
AEON										
100	Revo 100	04-10								
125	Overland 125	02-09								
180	Cobra 180 RS	02-03								
180	Cobra 180 RS II	04-08								
180	Overland 180	02-10								
APRILIA										
240	Climber (trial)	89-89								
275	Climber (trial)	89-89								
280	Climber R(trial)	92-92								
350	Tuareg	86-86								
350	Tuareg	89-89								
450	MXV450	09-14								
450	RXV450	06-14								
450	SXV450	06-14								
550	RXV550	06-14								
550	SXV550	06-14								
ARCTIC CAT										
50	2WD 50	04-05								
50	DVX50	06-11								
90	2WD 90	02-05								
90	DVX90	06-11								
250	Cat 2x4 250	99-04								
250	Cat 2x4 250	05-11								
250	Cat 4x4 250	00-04								
250	DVX250	06-08								
300	Cat 2x4 300	98-03								
300	Cat 2x4 300	04-04								
300	Cat 4x4 300	05-11								
400	Cat 2x4 400	98-04								
400	Cat 2x4 400	05-08								
400	Cat 4x4 400	98-04								
400	Cat 4x4 400	05-05								
400	DVX400	04-08								
400	TBX 4x4 400	04-05								
500	Cat 2x4 500	98-04								
500	Cat 4x4 500	98-03								
500	Cat 4x4 500	04-04								
500	Cat 4x4 500	05-10								
500	TBX 4x4 500	02-04								
500	TBX 4x4 500	05-10								
500	TRV 4x4 500	03-04								
500	TRV 4x4 500	05-11								
650	Cat 4x4 650 H1	05-11								
650	Cat 4x4 650 V2 /LE	05-11								
650	Prowler XT 650 4x4 H1	06-11								
700	Cat 4x4 700	07-11								
700	Wild Cat 700	16-17								
1000	Wild Cat 1000	16-17								
BENELLI										
449	BX449 Cross	07-11								
505	BX505 Enduro	08-08								
570	BX570 Motard	08-12								



Cyl.	Modèle	Années	sbs		sbs		sbs		sbs	
			PLAQUETTES AV	€ T.T.C.	PLAQUETTES AR	€ T.T.C.	DISQUE AV	€ T.T.C.	DISQUE AR	€ T.T.C.
BETA										
50	RK 6 (enduro)	97-98	148HF	17,80€	105HF	12,90€				
50	RR50 Enduro	12-13	168HF	17,80€	199HF	17,80€				
50	RR50 Enduro Factory	12-16	168HF	17,80€	199HF	17,80€				
50	RR50 Enduro Std	12-15	168HF	17,80€	199HF	17,80€				
80	Evo 80 Junior (Trial)	12-15	559HF	22,60€	559HF	22,60€				
80	Evo 80 Senior (Trial)	12-15	802HF	22,60€						
125	Alp 125	98-98	559RSI	39,80€	559RSI	39,80€				
125	Alp 125	99-00	559HF	22,60€	559HF	22,60€				
125	Alp 125	01-05	559RSI	39,80€	559RSI	39,80€				
125	Evo 125 (Trial)	12-22	802HF	22,60€	895HF	22,60€				
125	RR125 Enduro	15-16	774HF	22,60€	861HF	33,50€				
125	RR125 Enduro	18-22	694SI	28,40€	790SI	28,40€				
125	RR125 Enduro LC 4T	15-22	774HF	22,60€	861HF	33,50€				
125	RR125Mortard LC	21-21	774HF	22,60€	861HF	33,50€				
125	Zero (Trial)	90-92	802HF	22,60€	802HF	22,60€				
200	Alp 200	00-05	559RSI	39,80€	559RSI	39,80€				
200	Alp 200	15-21	774HF	22,60€	861HF	33,50€				
200	EVO (Tial)	12-20	802HF	22,60€	895HF	22,60€				
200	RR200 Enduro	19-22	694SI	28,40€	790SI	28,40€				
200	Urban	12-16	774HF	22,60€	861HF	33,50€				
240	Alp 240	90-91	595HF	21,24€	607HF	22,60€				
240	Alp 240	92-95	559HF	22,60€	636HF	29,04€				
240	Alp 240	96-97	559HF	22,60€	519HF	22,60€				
240	Super Trial	92-92	559RSI	39,80€	636HF	29,04€				
240	Techno (Trial)	97-97	559RSI	39,80€	636HF	29,04€				
250	Alp 250	92-96	559HF	22,60€	636HF	29,04€				
250	Alp 250	97-98	559HF	22,60€	559HF	22,60€				
250	EVO (Trial)	12-22	802HF	22,60€	895HF	22,60€				
250	EVO (Trial) 4T	12-19	802HF	22,60€	895HF	22,60€				
250	Rev3, 250	00-03	802HF	22,60€	802HF	22,60€				
250	RR250	05-07	694SI	28,40€	790SI	28,40€	5109	59,70€		
250	RR250 Enduro	13-15	694SI	28,40€	790SI	28,40€				
250	RR250 Enduro 2T	13-22	694SI	28,40€	790SI	28,40€				
250	Techno (Trial)	96-98	559HF	22,60€	559HF	22,60€				
250	XTrainer	18-22	694SI	28,40€	790SI	28,40€				
250	Zero (Trial)	91-91	559HF	22,60€	636HF	29,04€				
260	Alp 260 (Trial)	96-96	559HF	22,60€	519HF	22,60€				
260	Synt (Trial)	92-92	595HF	21,24€	636HF	29,04€				
260	TR34, 35, Zero	89-89	559HF	22,60€	636HF	29,04€				
300	300RR Enduro	11-12	694SI	28,40€	790HF	33,50€	5109	59,70€		
300	300RR Enduro	13-17	694SI	28,40€	790HF	33,50€				
300	300RR Enduro 2T	13-17	694SI	28,40€	790HF	33,50€				
300	300RR Enduro 2T	18-22	694SI	28,40€	790SI	28,40€				
300	EVO (Trial)	09-22	802HF	22,60€	895HF	22,60€				
300	EVO (Trial) 4T	12-22	802HF	22,60€	895HF	22,60€				
300	XTrainer	18-22	694SI	28,40€	790SI	28,40€				
350	350RR Enduro	12-12	694SI	28,40€	790SI	28,40€	5109	59,70€		
350	350RR Enduro	13-22	694SI	28,40€	790SI	28,40€				
350	Alp 4.0 350	04-05	774HF	22,60€	574HF	22,60€				
350	Motard 4.0 350	04-05	559HF	22,60€	574HF	22,60€				
390	RR390 Enduro	14-22	694SI	28,40€	790SI	28,40€				
400	RR400 Enduro	05-12	694SI	28,40€	790SI	28,40€	5109	59,70€		
400	RR400 Enduro	13-15	694SI	28,40€	790SI	28,40€				
430	RR430 Enduro	13-22	694SI	28,40€	790SI	28,40€				
450	RR450 Enduro	05-12	694SI	28,40€	790SI	28,40€	5109	59,70€		
450	RR450 Enduro	13-15	694SI	28,40€	790SI	28,40€				
480	RR480 Enduro	13-22	694SI	28,40€	790SI	28,40€				
498	RR498 Enduro	12-12	694SI	28,40€	790SI	28,40€				
498	RR498 Enduro	13-15	694SI	28,40€	790SI	28,40€				

BRAKING

		BRAKING		BRAKING		BRAKING		BRAKING				
		Années	DISQUE AV WAVE	€ T.T.C.	DISQUE AR WAVE	€ T.T.C.	DISQUE AV ROND	€ T.T.C.	DISQUE AR ROND	€ T.T.C.	DISQUE 270mm OVERSIZE	€ T.T.C.
BETA												
50	RK 6 (enduro)	97-98										
50	RR50 Enduro	12-13										
50	RR50 Enduro Factory	12-16										
50	RR50 Enduro Std	12-15										
80	Evo 80 Junior (Trial)	12-15										
80	Evo 80 Senior (Trial)	12-15										
125	Alp 125	98-98										
125	Alp 125	99-00										
125	Alp 125	01-05										
125	Evo 125 (Trial)	12-22										
125	RR125 Enduro	15-16										
125	RR125 Enduro	18-22	WL4016	195,10€	KT10RID	142,20€						
125	RR125 Enduro LC 4T	15-22										
125	RR125Mortard LC	21-21										
125	Zero (Trial)	90-92										
200	Alp 200	00-05										
200	Alp 200	15-21										
200	EVO (Tial)	12-20										
200	RR200 Enduro	19-22	WL4016	195,10€	KT10RID	142,20€						
200	Urban	12-16										
240	Alp 240	90-91										
240	Alp 240	92-95										
240	Alp 240	96-97										
240	Super Trial	92-92										
240	Techno (Trial)	97-97										
250	Alp 250	92-96										
250	Alp 250	97-98										
250	EVO (Trial)	12-22										
250	EVO (Trial) 4T	12-19										
250	Rev3, 250	00-03										
250	RR250	05-07	WL4002	195,10€	WF4501	142,30€						
250	RR250 Enduro	13-15	WL4016	195,10€	KT10RID	142,20€						
250	RR250 Enduro 2T	13-22	WL4016	195,10€	KT10RID	142,20€						
250	Techno (Trial)	96-98										
250	XTrainer	18-22	WL4016	195,10€	KT10RID	142,20€						
250	Zero (Trial)	91-91										
260	Alp 260 (Trial)	96-96										
260	Synt (Trial)	92-92										
260	TR34, 35, Zero	89-89										
300	300RR Enduro	11-12	WL4002	195,10€	WF4501	142,30€						
300	300RR Enduro	13-17	WL4016	195,10€	KT10RID	142,20€						
300	300RR Enduro 2T	13-17	WL4016	195,10€	KT10RID	142,20€						
300	300RR Enduro 2T	18-22	WL4016	195,10€	KT10RID	142,20€						
300	EVO (Trial)	09-22										
300	EVO (Trial) 4T	12-22										
300	XTrainer	18-22	WL4016	195,10€	KT10RID	142,20€						
350	350RR Enduro	12-12	WL4002	195,10€	WF4501	142,30€						
350	350RR Enduro	13-22	WL4016	195,10€	KT10RID	142,20€						
350	Alp 4.0 350	04-05										
350	Motard 4.0 350	04-05										
390	RR390 Enduro	14-22	WL4016	195,10€	KT10RID	142,20€						
400	RR400 Enduro	05-12	WL4002	195,10€	WF4501	142,30€						
400	RR400 Enduro	13-15	WL4016	195,10€	KT10RID	142,20€						
430	RR430 Enduro	13-22	WL4016	195,10€	KT10RID	142,20€						
450	RR450 Enduro	05-12	WL4002	195,10€	WF4501	142,30€						
450	RR450 Enduro	13-15	WL4016	195,10€	KT10RID	142,20€						
480	RR480 Enduro	13-22	WL4016	195,10€	KT10RID	142,20€						
498	RR498 Enduro	12-12	WL4002	195,10€	WF4501	142,30€						
498	RR498 Enduro	13-15	WL4016	195,10€	KT10RID	142,20€						

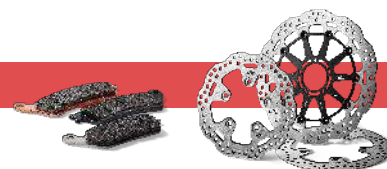

Cyl.	Modèle	Années	sbs		sbs		sbs		sbs	
			PLAQUETTES AV	€ T.T.C.	PLAQUETTES AR	€ T.T.C.	DISQUE AV	€ T.T.C.	DISQUE AR	€ T.T.C.
BETA										
520	RR520 Enduro	13-15	694SI	28,40€	790SI	28,40€				
525	RR525 Enduro	05-12	694SI	28,40€	790SI	28,40€	5109	59,70€		
BMW										
450	G450 X	08-11	671SI	28,40€	791SI	28,40€				
BOMBARDIER										
50	DS50	02-06	02048	28,20€	02041	40,30€				
50	Goes 50	06-06	02048	28,20€	02041	40,30€				
50	Quest 50	03-04	02048	28,20€	02041	40,30€				
90	DS90	02-06	02048	28,20€	02041	40,30€				
90	Quest 90	03-04	02048	28,20€	02041	40,30€				
200	Rally 200	03-04	544ATS	28,40€						
200	Rally 200	05-06	544ATS	28,40€	546ATS	28,40€				
250	DS250	06-06	754ATS 767ATS	28,40€ 28,40€	754ATS	28,40€				
330	Outlander 330	04-06	754ATS 767ATS	28,40€ 28,40€	754ATS	28,40€				
400	Outlander 400 /Max	03-06	754ATS 767ATS	28,40€ 28,40€	767ATS	28,40€				
500	Quest 500	02-06	754ATS 767ATS	28,40€ 28,40€	754ATS	28,40€				
500	Traxter 500	99-00	730HF	30,90€	730HF	30,90€				
500	Traxter 500	01-06	754ATS 767ATS	28,40€ 28,40€	767ATS	28,40€				
500	Traxter 500 Max	03-04	754ATS 767ATS	28,40€ 28,40€	767ATS	28,40€				
500	Traxter 500 Max	05-05	754ATS 767ATS	28,40€ 28,40€	754ATS	28,40€				
650	DS650 Desert Storm	00-06	754ATS 767ATS	28,40€ 28,40€	754ATS	28,40€				
650	Quest 650	02-06	754ATS 767ATS	28,40€ 28,40€	754ATS	28,40€				
650	Quest 650 Max	03-06	754ATS 767ATS	28,40€ 28,40€	767ATS	28,40€				
650	Traxter 650 Max	03-05	754ATS 767ATS	28,40€ 28,40€	767ATS	28,40€				
800	Outlander 800	06-06	754ATS 767ATS	28,40€ 28,40€	754ATS	28,40€				
800	Outlander 800 XT	06-06	754ATS 767ATS	28,40€ 28,40€	754ATS	28,40€				
CPI										
250	XS250	05-10	810ATS	28,40€	848ATS	28,40€				
DAELIM										
250	ST250 Sector Quad	05-06	544ATS	28,40€	201HF	17,80€				
50	DFW50	04-10	02048	28,20€	02026	40,50€				
200	DRX200	04-10	544ATS	28,40€	546ATS	28,40€				
250	DRX250	04-10	544ATS	28,40€	546ATS	28,40€				
E-TON										
150	Viper RXL-150 /ST	05-12	02012	21,30€	201HF	17,80€				
250	Vector VXL-250	05-08	544ATS	28,40€	201HF	17,80€				
250	Vector VXL-250 /ST	09-11	544ATS	28,40€	201HF	17,80€				
300	Vector VXL-300 /ST	06-12	544ATS	28,40€	201HF	17,80€				
300	Vortex VTX-300 /ST	06-12	544ATS	28,40€	201HF	17,80€				
FANTIC										
125	XE 125	21-22	840RSI	39,80€	790RSI	39,80€				
125	XX 125	21-21	840RSI	39,80€	790RSI	39,80€				
125	XX 125	22-22	965RSI	39,80€	790RSI	39,80€				
250	XEF 250	21-22	840SI	28,40€	790SI	28,40€				
250	XX 250	22-22	965RSI	39,80€	790RSI	39,80€				
250	XXF 250	22-22	965RSI	39,80€	790RSI	39,80€				
450	XEF 450	22-22	965SI	28,40€	790SI	28,40€				
450	XXF 450	22-22	965RSI	39,80€	790RSI	39,80€				

BRAKING

		BRAKING		BRAKING		BRAKING		BRAKING				
		Années	DISQUE AV WAVE	€ T.T.C.	DISQUE AR WAVE	€ T.T.C.	DISQUE AV ROND	€ T.T.C.	DISQUE AR ROND	€ T.T.C.	DISQUE 270mm OVERSIZE	€ T.T.C.
BETA												
520	RR520 Enduro	13-15	WL4016	195,10€	KT10RID	142,20€						
525	RR525 Enduro	05-12	WL4002	195,10€	WF4501	142,30€						
BMW												
450	G450 X	08-11										
BOMBARDIER												
50	DS50	02-06										
50	Goes 50	06-06										
50	Quest 50	03-04										
90	DS90	02-06										
90	Quest 90	03-04										
200	Rally 200	03-04										
200	Rally 200	05-06										
250	DS250	06-06										
330	Outlander 330	04-06										
400	Outlander 400 /Max	03-06										
500	Quest 500	02-06										
500	Traxter 500	99-00										
500	Traxter 500	01-06										
500	Traxter 500 Max	03-04										
500	Traxter 500 Max	05-05										
650	DS650 Desert Storm	00-06										
650	Quest 650	02-06										
650	Quest 650 Max	03-06										
650	Traxter 650 Max	03-05										
800	Outlander 800	06-06										
800	Outlander 800 XT	06-06										
CPI												
250	XS250	05-10										
DAELIM												
250	ST250 Sector Quad	05-06										
50	DFW50	04-10										
200	DRX200	04-10										
250	DRX250	04-10										
E-TON												
150	Viper RXL-150 /ST	05-12										
250	Vector VXL-250	05-08										
250	Vector VXL-250 /ST	09-11										
300	Vector VXL-300 /ST	06-12										
300	Vortex VTX-300 /ST	06-12										
FANTIC												
125	XE 125	21-22	WL4010	195,90€	WF4515 WF4516	138,20€						
125	XX 125	21-21	WL4010	195,90€	WF4515 WF4516	138,20€						
125	XX 125	22-22	WL4010	195,90€	WF4515 WF4516	138,20€						
250	XEF 250	21-22	WL4010	195,90€	WF4515 WF4516	138,20€						
250	XX 250	22-22	WL4010	195,90€	WF4515 WF4516	138,20€						
250	XXF 250	22-22	WL4010	195,90€	WF4515 WF4516	138,20€						
450	XEF 450	22-22	WL4010	195,90€	WF4515 WF4516	138,20€						
450	XXF 450	22-22	WL4010	195,90€	WF4515 WF4516	138,20€						



Cyl.	Modèle	Années	sbs		sbs		sbs		sbs	
			PLAQUETTES AV	€ T.T.C.	PLAQUETTES AR	€ T.T.C.	DISQUE AV	€ T.T.C.	DISQUE AR	€ T.T.C.
GAS GAS										
50	EC50 Boy	00-07	815HF	30,90€	815HF	30,90€				
50	MC50	21-22	794RSI	39,80€	794RSI	39,80€				
50	Wild HP 50	04-05	671ATS	28,40€	671ATS	28,40€				
65	MC65	05-13	815HF	30,90€	815HF	30,90€				
65	MC65	21-22	783RSI	39,80€	783RSI	39,80€				
85	MC85 14/17 pouces	22-22	671RSI	39,80€	791RSI	39,80€	5064	71,90€	5049	84,10€
85	MC85 16/19 pouces	21-22	671RSI	39,80€	791RSI	39,80€	5064	71,90€	5049	84,10€
125	EC125	97-00	671SI	28,40€	675SI	28,40€			5133	73,10€
125	EC125	01-10	694SI	28,40€	604SI	28,40€			5133	73,10€
125	EC125	11-14	694SI	28,40€	790SI	28,40€			5133	73,10€
125	MC125	01-01	694SI	28,40€	604SI	28,40€			5133	73,10€
125	MC125	02-03	694RSI	39,80€	604RSI	39,80€			5133	73,10€
125	MC125	04-09	694SI	28,40€	604SI	28,40€			5133	73,10€
125	MC125	10-13	694SI	28,40€	604SI	28,40€			5133	73,10€
125	MC125	21-22	671RSI	39,80€	791RSI	39,80€	5066	96,20€	5049	84,10€
125	Pampera 125	96-96	559SI	28,40€	559SI	28,40€				
125	Pampera 125	97-01	559HF	22,60€	559HF	22,60€				
125	Pampera 125	02-03	559SI	28,40€	559SI	28,40€				
125	Pampera 125	04-04	774HF	22,60€	815HF	30,90€				
125	SM125	02-09	566HF	30,90€	604HF	33,80€				
125	TXT125	00-03	802HF	22,60€	803HF	22,60€				
125	TXT125 Pro	04-13	802HF	22,60€	803HF	22,60€				
125	TXT125 Pro	14-17	939RSI	39,80€	803RSI	39,80€				
125	TXT125 Racing	18-22	939RSI	39,80€	803RSI	39,80€				
200	EC200	99-99	671SI	28,40€	675SI	28,40€			5133	73,10€
200	EC200	00-20	694SI	28,40€	604SI	28,40€			5133	73,10€
200	EC200 Hobby	99-99	671SI	28,40€	675SI	28,40€				
200	EC200 Hobby	00-06	694SI	28,40€	604SI	28,40€				
200	EC200 Hobby	07-13	694SI	28,40€	604SI	28,40€			5133	73,10€
200	EC200 Ranger	19-20	671SI	28,40€	791SI	28,40€			5133	73,10€
200	MC200	04-08							5133	73,10€
200	MC200 Hobby	02-06							5133	73,10€
200	TX200	97-99	559SI	28,40€	559SI	28,40€				
200	TXT200	04-13	802HF	22,60€	803HF	22,60€				
240	Wild HP 240	04-05	671ATS	28,40€	671ATS	28,40€				
250	EC250	96-00	671SI	28,40€	675SI	28,40€			5133	73,10€
250	EC250	01-10	694SI	28,40€	604SI	28,40€			5133	73,10€
250	EC250	11-20	694SI	28,40€	790SI	28,40€			5133	73,10€
250	EC250	21-22	671SI	28,40€	791SI	28,40€	5066	96,20€	5049	84,10€
250	EC250F	21-22	671SI	28,40€	791SI	28,40€	5066	96,20€	5049	84,10€
250	MC250	97-01	671SI	28,40€	675SI	28,40€			5133	73,10€
250	MC250	02-09	694SI	28,40€	604SI	28,40€			5133	73,10€
250	MC250	22-22	671SI	28,40€	791SI	28,40€	5066	96,20€	5049	84,10€
250	MC250F	21-22	671SI	28,40€	791SI	28,40€	5066	96,20€	5049	84,10€
250	MX250	05-07	694SI	28,40€	604SI	28,40€				
250	Pampera 250	97-01	559HF	22,60€	559HF	22,60€				

BRAKING

		BRAKING		BRAKING		BRAKING		BRAKING				
		Années	DISQUE AV WAVE	€ T.T.C.	DISQUE AR WAVE	€ T.T.C.	DISQUE AV ROND	€ T.T.C.	DISQUE AR ROND	€ T.T.C.	DISQUE 270mm OVERSIZE	€ T.T.C.
GAS GAS												
50	EC50 Boy	00-07										
50	MC50	21-22										
50	Wild HP 50	04-05										
65	MC65	05-13										
65	MC65	21-22	KT06FID	113,30€	KT06RID	113,30€						
85	MC85 14/17 pouces	22-22	WF4102	142,20€	KT11RID WF4505	113,80€ 113,80€						
85	MC85 16/19 pouces	21-22	WF4102	142,20€	KT11RID WF4505	113,80€ 113,80€						
125	EC125	97-00	GA04FLD	195,10€	KT11RID WF4505	113,80€ 113,80€						
125	EC125	01-10	GA04FLD	195,10€	KT11RID WF4505	113,80€ 113,80€						
125	EC125	11-14	GA04FLD	195,10€	KT11RID WF4505	113,80€ 113,80€						
125	MC125	01-01	GA04FLD	195,10€	KT11RID WF4505	113,80€ 113,80€						
125	MC125	02-03	GA04FLD	195,10€	KT11RID WF4505	113,80€ 113,80€						
125	MC125	04-09	GA04FLD	195,10€	KT11RID WF4505	113,80€ 113,80€						
125	MC125	10-13										
125	MC125	21-22	KT02FID	142,30€	KT11RID WF4505	113,80€ 113,80€						
125	Pampera 125	96-96										
125	Pampera 125	97-01										
125	Pampera 125	02-03										
125	Pampera 125	04-04										
125	SM125	02-09										
125	TXT125	00-03										
125	TXT125 Pro	04-13										
125	TXT125 Pro	14-17										
125	TXT125 Racing	18-22										
200	EC200	99-99	GA04FLD	195,10€	KT11RID WF4505	113,80€ 113,80€						
200	EC200	00-20	GA04FLD	195,10€	KT11RID WF4505	113,80€ 113,80€						
200	EC200 Hobby	99-99										
200	EC200 Hobby	00-06										
200	EC200 Hobby	07-13	GA04FLD	195,10€	KT11RID WF4505	113,80€ 113,80€						
200	EC200 Ranger	19-20	GA04FLD	195,10€	KT11RID WF4505	113,80€ 113,80€						
200	MC200	04-08	GA04FLD	195,10€	KT11RID WF4505	113,80€ 113,80€						
200	MC200 Hobby	02-06	GA04FLD	195,10€	KT11RID WF4505	113,80€ 113,80€						
200	TX200	97-99										
200	TXT200	04-13										
240	Wild HP 240	04-05										
250	EC250	96-00	GA04FLD	195,10€	KT11RID WF4505	113,80€ 113,80€						
250	EC250	01-10	GA04FLD	195,10€	KT11RID WF4505	113,80€ 113,80€						
250	EC250	11-20	GA04FLD	195,10€	KT11RID WF4505	113,80€ 113,80€						
250	EC250	21-22	KT02FID	142,30€	KT11RID WF4505	113,80€ 113,80€						
250	EC250F	21-22	KT02FID	142,30€	KT11RID WF4505	113,80€ 113,80€						
250	MC250	97-01	GA04FLD	195,10€	KT11RID WF4505	113,80€ 113,80€						
250	MC250	02-09	GA04FLD	195,10€	KT11RID WF4505	113,80€ 113,80€						
250	MC250	22-22	KT02FID	142,30€	KT11RID WF4505	113,80€ 113,80€						
250	MC250F	21-22	KT02FID	142,30€	KT11RID WF4505	113,80€ 113,80€						
250	MX250	05-07										
250	Pampera 250	97-01										



Cyl.	Modèle	Années	sbs		sbs		sbs		sbs	
			PLAQUETTES AV	€ T.T.C.	PLAQUETTES AR	€ T.T.C.	DISQUE AV	€ T.T.C.	DISQUE AR	€ T.T.C.
GAS GAS										
250	Pampera 250	02-04	774HF	22,60€	815HF	30,90€				
250	TXT250	04-13	802HF	22,60€	803HF	22,60€				
250	TXT250	14-22	939RSI	39,80€	803RSI	39,80€				
270	TX270	97-99	559SI	28,40€	559SI	28,40€				
280	TXT280	04-14	802HF	22,60€	803HF	22,60€				
280	TXT280	14-22	939RSI	39,80€	803RSI	39,80€				
300	EC300	99-00	671SI	28,40€	675SI	28,40€			5133	73,10€
300	EC300	01-10	694SI	28,40€	604SI	28,40€			5133	73,10€
300	EC300	11-20	694SI	28,40€	790SI	28,40€			5133	73,10€
300	EC300	21-22	671SI	28,40€	791SI	28,40€	5066	96,20€	5049	84,10€
300	EC300 Ranger	19-20	671SI	28,40€	791SI	28,40€				
300	TXT300	04-06	802HF	22,60€	803HF	22,60€				
300	TXT300 Pro	07-12	802HF	22,60€	803HF	22,60€				
300	TXT300 Pro	13-22	939RSI	39,80€	803RSI	39,80€				
300	Wild HP 300	03-05	671ATS	28,40€	671ATS	28,40€				
320	TX320	97-99	559SI	28,40€	559SI	28,40€				
350	EC350F	21-22	671SI	28,40€	791SI	28,40€	5066	96,20€	5049	84,10€
350	MC350F	22-22	671SI	28,40€	791SI	28,40€	5066	96,20€	5049	84,10€
370	Pampera 370	96-97	559SI	28,40€	559SI	28,40€				
370	Pampera 370	98-98	559RSI	39,80€	559RSI	39,80€				
370	Pampera 370	99-99	559HF	22,60€	559HF	22,60€				
400	EC400 FSE	02-09	694SI	28,40€	604SI	28,40€			5133	73,10€
400	Pampera 400	05-09	694SI	28,40€	604SI	28,40€				
450	EC450 FSE	02-06	694SI	28,40€	604SI	28,40€			5133	73,10€
450	EC450 FSR	07-14	694SI	28,40€	604SI	28,40€			5133	73,10€
450	MC450F	21-22	671RSI	39,80€	791RSI	39,80€	5066	96,20€	5049	84,10€
450	Pampera 450	08-13	694SI	28,40€	604SI	28,40€				
450	Wild HP 450	03-05	671ATS	28,40€	671ATS	28,40€				
515	EC515 FSR	08-09	694SI	28,40€	604SI	28,40€			5133	73,10€
GOES										
520	G520 F /MAX	12-14	914ATS	28,40€	799ATS	28,40€				
625	G625i /MAX	10-14	914ATS	28,40€	799ATS	28,40€				
HM										
50	CRE50 Baja	97-00	548HF	33,50€	548HF	33,50€				
50	CRE50 Baja	07-16	774HF	22,60€	604HF	33,80€				
50	CRE50 Enduro	98-05	608HF	30,90€	548HF	33,50€				
50	CRE50 Enduro	06-06	774HF	22,60€	604HF	33,80€				
50	CRE50 Six Comp?tition	07-16	928HF	33,50€	790HF	33,50€				
50	CRM50 D?rapage	07-16	928HF	33,50€	790HF	33,50€				
50	CRM50 Six Comp?tition	07-16	928HF	33,50€	790HF	33,50€				
125	CR125 Supermotard	04-06	694SI	28,40€	777SI	28,40€			5098	73,10€
125	CRE125 Enduro	95-01	694SI	28,40€	604SI	28,40€	5003	79,20€		
125	CRE125 Enduro	02-06	694SI	28,40€	777SI	28,40€	5003	79,20€		
125	CRE125 Supermotard	03-12	694SI	28,40€	604SI	28,40€			5098	73,10€
125	CRM125 D?rapage 2T	11-16	928HF	33,50€	790HF	33,50€				
125	CRM125 F 4T	11-16	928HF	33,50€	790HF	33,50€				
125	CRM125 X Supermotard	07-13	843RSI	39,90€	777SI	28,40€				
230	CRF230 Easy	04-04	694HF	33,50€	604HF	33,80€			5098	73,10€
230	CRF230 Easy	05-06	694SI	28,40€	604SI	28,40€			5098	73,10€
250	CRE250 Enduro	95-01	694SI	28,40€	604SI	28,40€	5003	79,20€	5098	73,10€
250	CRE250 Enduro	02-03	694SI	28,40€	777SI	28,40€	5003	79,20€	5098	73,10€

BRAKING

		BRAKING		BRAKING		BRAKING		BRAKING				
		Années	DISQUE AV WAVE	€ T.T.C.	DISQUE AR WAVE	€ T.T.C.	DISQUE AV ROND	€ T.T.C.	DISQUE AR ROND	€ T.T.C.	DISQUE 270mm OVERSIZE	€ T.T.C.
GAS GAS												
250	Pampera 250	02-04										
250	TXT250	04-13										
250	TXT250	14-22										
270	TX270	97-99										
280	TXT280	04-14										
280	TXT280	14-22										
300	EC300	99-00	GA04FLD	195,10€	KT11RID WF4505	113,80€ 113,80€						
300	EC300	01-10	GA04FLD	195,10€	KT11RID WF4505	113,80€ 113,80€						
300	EC300	11-20	GA04FLD	195,10€	KT11RID WF4505	113,80€ 113,80€						
300	EC300	21-22	KT02FID	142,30€	KT11RID WF4505	113,80€ 113,80€						
300	EC300 Ranger	19-20										
300	TXT300	04-06										
300	TXT300 Pro	07-12										
300	TXT300 Pro	13-22										
300	Wild HP 300	03-05										
320	TX320	97-99										
350	EC350F	21-22	KT02FID	142,30€	KT11RID WF4505	113,80€ 113,80€						
350	MC350F	22-22	KT02FID	142,30€	KT11RID WF4505	113,80€ 113,80€						
370	Pampera 370	96-97										
370	Pampera 370	98-98										
370	Pampera 370	99-99										
400	EC400 FSE	02-09	GA04FLD	195,10€	KT11RID WF4505	113,80€ 113,80€						
400	Pampera 400	05-09										
450	EC450 FSE	02-06	GA04FLD	195,10€	KT11RID WF4505	113,80€ 113,80€						
450	EC450 FSR	07-14	GA04FLD	195,10€	KT11RID WF4505	113,80€ 113,80€						
450	MC450F	21-22	KT02FID	142,30€	KT11RID WF4505	113,80€ 113,80€						
450	Pampera 450	08-13										
450	Wild HP 450	03-05										
515	EC515 FSR	08-09			KT11RID WF4505	113,80€ 113,80€						
GOES												
520	G520 F /MAX	12-14										
625	G625i /MAX	10-14										
HM												
50	CRE50 Baja	97-00										
50	CRE50 Baja	07-16										
50	CRE50 Enduro	98-05										
50	CRE50 Enduro	06-06										
50	CRE50 Six Comp?titon	07-16										
50	CRM50 D?rapage	07-16										
50	CRM50 Six Comp?titon	07-16										
125	CR125 Supermotard	04-06			HO60RID WF7508	142,30€ 140,80€						
125	CRE125 Enduro	95-01										
125	CRE125 Enduro	02-06										
125	CRE125 Supermotard	03-12			HO60RID WF7508	142,30€ 140,80€						
125	CRM125 D?rapage 2T	11-16										
125	CRM125 F 4T	11-16										
125	CRM125 X Supermotard	07-13										
230	CRF230 Easy	04-04	HO25FID	142,30€	HO60RID WF7508	142,30€ 140,80€						
230	CRF230 Easy	05-06	HO25FID	142,30€	HO60RID WF7508	142,30€ 140,80€						
250	CRE250 Enduro	95-01	HO25FID	142,30€								
250	CRE250 Enduro	02-03	HO25FID	142,30€								

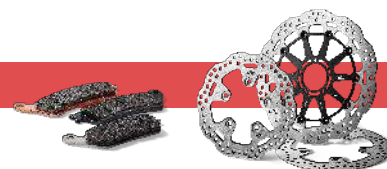

Cyl.	Modèle	Années	sbs		sbs		sbs		sbs	
			PLAQUETTES AV	€ T.T.C.	PLAQUETTES AR	€ T.T.C.	DISQUE AV	€ T.T.C.	DISQUE AR	€ T.T.C.
HM										
250	CRE250 Enduro	04-06	694SI	28,40€	777SI	28,40€	5003	79,20€	5098	73,10€
250	CRE250 F Enduro	04-04	694RSI	39,80€	777RSI	39,80€	5003	79,20€	5098	73,10€
250	CRE250 F Enduro	05-06	694SI	28,40€	777SI	28,40€	5003	79,20€	5098	73,10€
250	CRE250 X Enduro	04-06	694SI	28,40€	777SI	28,40€	5003	79,20€	5098	73,10€
450	CRE450 F Enduro	02-05	694SI	28,40€	777SI	28,40€	5003	79,20€	5098	73,10€
450	CRE450 X Enduro	04-13	694SI	28,40€	777SI	28,40€	5003	79,20€	5098	73,10€
HONDA										
50	CRF50	04-22	02010	24,10€	02010	24,10€				
50	QR 50	82-93	02010	24,10€	02011	24,10€				
50	XR50	00-03	02010	24,10€	02010	24,10€				
70	CRF70	04-13	02057	28,20€	02057	28,20€				
70	TRX70	86-87	02048	28,20€	02041	40,30€				
70	XR70 R	95-03	02057	28,20€	02057	28,20€				
80	CR80 R	80-81	02013	24,10€	02013	24,10€				
80	CR80 R	82-82	02013	24,10€	02057	28,20€				
80	CR80 R	83-84	02057	28,20€	02057	28,20€				
80	CR80 R	85-85	02057	28,20€	02043	28,20€				
80	CR80 R	86-86	584SI	28,40€	02043	28,20€				
80	CR80 R	87-91	584RSI	39,80€	02043	28,20€				
80	CR80 R	92-95	584RSI	39,80€	604SI	28,40€				
80	CR80 R	96-02	584RSI	39,80€	604SI	28,40€				
80	CRF80	04-09	02057	28,20€	02057	28,20€				
80	XR80	79-84	02013	24,10€	02013	24,10€				
80	XR80	86-90	02057	28,20€	02057	28,20€				
80	XRR80	85-91	02057	28,20€	02057	28,20€				
85	CR85	03-08	592SI	28,40€	604SI	28,40€				
100	CRF100	04-13	02057	28,20€	02057	28,20€				
100	XR100	81-85	02013	24,10€	02013	24,10€				
100	XRR100	85-04	02057	28,20€	02057	28,20€				
110	CRF 110	13-21	02057	28,20€	02057	28,20€				
125	CR125 R	87-88	603SI	28,40€	604SI	28,40€				
125	CR125 R	89-91	603SI	28,40€	604SI	28,40€				
125	CR125 R	92-94	603SI	28,40€	604SI	28,40€				
125	CR125 R	95-97	694SI	28,40€	604SI	28,40€	5003	79,20€	5001	84,10€
125	CR125 R	98-01	694SI	28,40€	604SI	28,40€	5003	79,20€	5018	79,20€
125	CR125 R	02-07	694RSI	39,80€	777RSI	39,80€	5003	79,20€	5098	73,10€
125	CRF125 F	14-21	694SI	28,40€	02057	28,20€				
150	CRF150 F	03-06	694SI	28,40€	02013	24,10€	5031	79,20€		
150	CRF150 F	07-14	694SI	28,40€	02013	24,10€	5031	79,20€		
150	CRF150 R	07-15	592RSI	39,80€	777SI	28,40€			5098	73,10€
200	TL J,Y 200	76-76	02013	24,10€	02013	24,10€				
200	TLR D,E,F 200	83-85	02057	28,20€	02057	28,20€				
200	TLR G,H 200	86-87	02013	24,10€	02057	28,20€				
200	TRX 200	84-84	02044	56,50€	02019	36,30€				
200	TRX200 (Type2)	97-97	02083	52,50€	02019	36,30€				
230	CRF230 F	03-04	694HF	33,50€	02013	24,10€				
230	CRF230 F	05-08	694SI	28,40€	02013	24,10€				
230	CRF230 F	09-10	694SI	28,40€	604SI	28,40€				
230	CRF230 F	11-14	694SI	28,40€	604SI	28,40€				
250	COTA 4T RT (Trial)	05-05			803RSI	39,80€				
250	CR250 R	88-91	603SI	28,40€	604SI	28,40€				
250	CR250 R	92-94	603SI	28,40€	604SI	28,40€				
250	CR250 R	95-95	603SI	28,40€	604SI	28,40€	5003	79,20€		
250	CR250 R	96-96	694SI	28,40€	604SI	28,40€	5003	79,20€		
250	CR250 R	97-01	694SI	28,40€	604SI	28,40€	5003	79,20€	5018	79,20€

BRACING

		BRACING			BRACING		BRACING		BRACING			
		Années	DISQUE AV WAVE	€ T.T.C.	DISQUE AR WAVE	€ T.T.C.	DISQUE AV ROND	€ T.T.C.	DISQUE AR ROND	€ T.T.C.	DISQUE 270mm OVERSIZE	€ T.T.C.
HM												
250	CRE250 Enduro	04-06	HO25FID	142,30€	HO60RID WF7508	142,30€ 140,80€					WL4003 POW79	195,10€ 66,70€
250	CRE250 F Enduro	04-04	HO25FID	142,30€	HO60RID WF7508	142,30€ 140,80€					WL4003 POW79	195,10€ 66,70€
250	CRE250 F Enduro	05-06	HO25FID	142,30€	HO60RID WF7508	142,30€ 140,80€					WL4003 POW79	195,10€ 66,70€
250	CRE250 X Enduro	04-06	HO25FID	142,30€	HO60RID WF7508	142,30€ 140,80€					WL4003 POW79	195,10€ 66,70€
450	CRE450 F Enduro	02-05	HO25FID	142,30€	HO60RID WF7508	142,30€ 140,80€					WL4003 POW79	195,10€ 66,70€
450	CRE450 X Enduro	04-13	HO25FID	142,30€	HO60RID WF7508	142,30€ 140,80€					WL4003 POW79	195,10€ 66,70€
HONDA												
50	CRF50	04-22										
50	QR 50	82-93										
50	XR50	00-03										
70	CRF70	04-13										
70	TRX70	86-87										
70	XR70 R	95-03										
80	CR80 R	80-81										
80	CR80 R	82-82										
80	CR80 R	83-84										
80	CR80 R	85-85			HO06RID	113,30€						
80	CR80 R	86-86			HO06RID	113,30€						
80	CR80 R	87-91			HO06RID	113,30€						
80	CR80 R	92-95			HO06RID	113,30€						
80	CR80 R	96-02	HO24FID	113,30€	HO06RID	113,30€						
80	CRF80	04-09										
80	XR80	79-84										
80	XR80	86-90										
80	XRR80	85-91										
85	CR85	03-08	HO24FID	113,30€	HO06RID	113,30€						
100	CRF100	04-13										
100	XR100	81-85										
100	XRR100	85-04										
110	CRF 110	13-21										
125	CR125 R	87-88										
125	CR125 R	89-91							HO02RI	99,20€		
125	CR125 R	92-94					HO13FI	127,60€	HO02RI	99,20€		
125	CR125 R	95-97	HO25FID	142,30€					HO02RI	99,20€		
125	CR125 R	98-01	HO25FID	142,30€	HO25RID	141,70€			HO25RI	130,80€		
125	CR125 R	02-07	HO25FID	142,30€	HO60RID WF7508	142,30€ 140,80€						
125	CRF125 F	14-21										
150	CRF150 F	03-06										
150	CRF150 F	07-14	HO24FID	113,30€	HO06RID	113,30€						
150	CRF150 R	07-15	HO24FID	113,30€	HO06RID	113,30€						
200	TL J,Y 200	76-76										
200	TLR D,E,F 200	83-85										
200	TLR G,H 200	86-87										
200	TRX 200	84-84										
200	TRX200 (Type2)	97-97										
230	CRF230 F	03-04	HO09FID	142,20€								
230	CRF230 F	05-08	HO09FID	142,20€								
230	CRF230 F	09-10	HO09FID	142,20€								
230	CRF230 F	11-14										
250	COTA 4T RT (Trial)	05-05										
250	CR250 R	88-91							HO02RI	99,20€		
250	CR250 R	92-94					HO13FI	127,60€	HO02RI	99,20€		
250	CR250 R	95-95	HO25FID	142,30€					HO02RI	99,20€		
250	CR250 R	96-96	HO25FID	142,30€					HO02RI	99,20€		
250	CR250 R	97-01	HO25FID	142,30€	HO25RID	141,70€			HO25RI	130,80€		

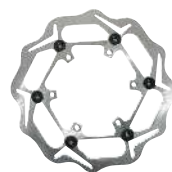

Cyl.	Modèle	Années	sbs		sbs		sbs		sbs	
			PLAQUETTES AV	€ T.T.C.	PLAQUETTES AR	€ T.T.C.	DISQUE AV	€ T.T.C.	DISQUE AR	€ T.T.C.
HONDA										
250	CR250 R	02-03	694RSI	39,80€	777RSI	39,80€	5003	79,20€	5098	73,10€
250	CR250 R	04-08	694RSI	39,80€	777RSI	39,80€	5003	79,20€	5098	73,10€
250	CRF250 R	04-14	694RSI	39,80€	777RSI	39,80€	5003	79,20€	5098	73,10€
250	CRF250 R	15-18	694RSI	39,80€	777RSI	39,80€	5072	103,60€	5098	73,10€
250	CRF250 R	19-22	694RSI	39,80€	777RSI	39,80€	5072	103,60€	5098	73,10€
250	CRF250 RX	20-22	694RSI	39,80€	777RSI	39,80€	5072	103,60€	5098	73,10€
250	CRF250 X	04-15	694RSI	39,80€	777RSI	39,80€	5003	79,20€	5098	73,10€
250	Fourtrax 250 R	04-04	603ATS	28,40€	558ATS	28,40€				
250	TL250 K1	79-79	02013	24,10€	02013	24,10€				
250	TLR250	85-85	02013	24,10€	02013	24,10€				
250	TRX250 R	90-90	603ATS	28,40€	558ATS	28,40€				
250	TRX250 R	91-92	603ATS	28,40€	558ATS	28,40€				
250	TRX250 R /Fourtrax [US]	86-86	603ATS	28,40€	558ATS	28,40€				
250	TRX250 R /Fourtrax [US]	87-89	603ATS	28,40€	592ATS	28,40€				
250	TRX250 Sportrax EX	01-08	592ATS	28,40€	02055	48,50€				
250	TRX250 X	10-12	592ATS	28,40€	02055	48,50€				
250	TRX250 X [US]	87-92	603ATS	28,40€	558ATS	28,40€				
300	CRF300 RX	21-22	694RSI	39,80€	777RSI	39,80€	5072	103,60€	5098	73,10€
300	TRX300 Sportrax EX	00-08	592ATS	28,40€	592ATS	28,40€				
300	TRX300 Sportrax EX	09-09			592ATS	28,40€				
350	TRX350 FE /TE /FM	00-06	02085	52,50€	02207	48,50€				
400	CRF400 RX	21-22	694RSI	39,80€	777RSI	39,80€	5072	103,60€	5098	73,10€
400	TRX Foreman	95-03	02085	52,50€	02207	48,50€				
400	TRX400 Fourtrax	99-00	02085	52,50€	02207	48,50€			5005	85,30€
400	TRX400 Fourtrax	01-09	02085	52,50€	02207	48,50€				
400	TRX400 Sportrax	99-09	592ATS	28,40€	592ATS	28,40€			5005	85,30€
400	XR400 R	96-06	694SI	28,40€	604SI	28,40€	5031	79,20€	5110	71,90€
400	XR400 Supermotard	96-96	694SI	28,40€	604SI	28,40€	5031	79,20€	5110	71,90€
400	XR400 Supermotard	97-06	694SI	28,40€	604SI	28,40€			5110	71,90€
420	TRX420 Fourtrax	10-12	592ATS	28,40€	813ATS	28,40€				
450	CR450 R	81-81	02030	40,30€						
450	CRF450 R	02-03	694RSI	39,80€	777RSI	39,80€	5003	79,20€	5098	73,10€
450	CRF450 R	04-14	694RSI	39,80€	777RSI	39,80€	5003	79,20€	5098	73,10€
450	CRF450 R	15-18	694RSI	39,80€	777RSI	39,80€	5072	103,60€	5098	73,10€
450	CRF450 R	19-22	694RSI	39,80€	777RSI	39,80€	5072	103,60€	5098	73,10€
450	CRF450 RX	17-18	694SI	28,40€	777SI	28,40€	5072	103,60€	5098	73,10€
450	CRF450 RX	19-22	694RSI	39,80€	777RSI	39,80€	5072	103,60€	5098	73,10€
450	CRF450 X	05-05	694RSI	39,80€	777RSI	39,80€	5003	79,20€	5098	73,10€
450	CRF450 X	06-16	694SI	28,40€	777SI	28,40€	5003	79,20€	5098	73,10€
450	CRF450 X	17-18	694SI	28,40€	777SI	28,40€	5072	103,60€	5098	73,10€
450	CRF450 X	19-20	694SI	28,40€	777SI	28,40€	5072	103,60€	5098	73,10€
450	TRX450 Foreman	98-04	02085	52,50€	02207	48,50€				
450	TRX450 R	04-09	694ATS	28,40€	813ATS	28,40€				
450	TRX450 Sportrax	01-09	592ATS	28,40€	592ATS	28,40€				
480	CR480 R	82-82	02030	40,30€	02041	40,30€				
480	CR480 R	83-83			02042	44,40€				
500	CR500 R	84-85	558SI	28,40€	02042	44,40€				
500	CR500 R	86-86	558SI	28,40€	02047	48,50€				
500	CR500 R	87-87	603SI	28,40€	604SI	28,40€				

BRAKING

				BRAKING		BRAKING		BRAKING		BRAKING		
		Années	DISQUE AV WAVE	€ T.T.C.	DISQUE AR WAVE	€ T.T.C.	DISQUE AV ROND	€ T.T.C.	DISQUE AR ROND	€ T.T.C.	DISQUE 270mm OVERSIZE	€ T.T.C.
HONDA												
250	CR250 R	02-03	HO25FID	142,30€	HO60RID WF7508	142,30€ 140,80€						
250	CR250 R	04-08	HO25FID	142,30€	HO60RID WF7508	142,30€ 140,80€					WL4003 POW79	195,10€ 66,70€
250	CRF250 R	04-14	HO25FID	142,30€	HO60RID WF7508	142,30€ 140,80€					WL4003 POW79	195,10€ 66,70€
250	CRF250 R	15-18	WF4104	142,30€	HO60RID WF7508	142,30€ 140,80€					WL4003 PW4015	195,10€ 66,70€
250	CRF250 R	19-22	WF4104	142,30€	HO60RID WF7508	142,30€ 140,80€					WL4003 PW4023	195,10€ 66,70€
250	CRF250 RX	20-22	WF4104	142,30€	HO60RID WF7508	142,30€ 140,80€					WL4003 PW4023	195,10€ 66,70€
250	CRF250 X	04-15	HO25FID	142,30€	HO60RID WF7508	142,30€ 140,80€					WL4003 POW79	195,10€ 66,70€
250	Fourtrax 250 R	04-04										
250	TL250 K1	79-79										
250	TLR250	85-85										
250	TRX250 R	90-90	HO41FID	112,40€								
250	TRX250 R	91-92										
250	TRX250 R /Fourtrax [US]	86-86										
250	TRX250 R /Fourtrax [US]	87-89										
250	TRX250 Sportrax EX	01-08	HO41FID	112,40€								
250	TRX250 X	10-12										
250	TRX250 X [US]	87-92	HO41FID	112,40€								
300	CRF300 RX	21-22	WF4104	142,30€	HO60RID WF7508	142,30€ 140,80€					WL4003 PW4023	195,10€ 66,70€
300	TRX300 Sportrax EX	00-08	HO41FID	112,40€								
300	TRX300 Sportrax EX	09-09										
350	TRX350 FE /TE /FM	00-06										
400	CRF400 RX	21-22	WF4104	142,30€	HO60RID WF7508	142,30€ 140,80€					WL4003 PW4023	195,10€ 66,70€
400	TRX Foreman	95-03										
400	TRX400 Fourtrax	99-00										
400	TRX400 Fourtrax	01-09										
400	TRX400 Sportrax	99-09	HO41FID	112,40€	HO47RID	112,40€						
400	XR400 R	96-06	HO09FID	142,20€	HO09RID	113,30€	HO09FI	115,10€	HO09RI	99,60€		
400	XR400 Supermotard	96-96			HO09RID	113,30€			HO09RI	99,60€		
400	XR400 Supermotard	97-06			HO09RID	113,30€			HO09RI	99,60€		
420	TRX420 Fourtrax	10-12										
450	CR450 R	81-81										
450	CRF450 R	02-03	HO25FID	142,30€	HO60RID WF7508	142,30€ 140,80€						
450	CRF450 R	04-14	HO25FID	142,30€	HO60RID WF7508	142,30€ 140,80€					WL4003 POW79	195,10€ 66,70€
450	CRF450 R	15-18	WF4104	142,30€	HO60RID WF7508	142,30€ 140,80€					WL4003 PW4015	195,10€ 66,70€
450	CRF450 R	19-22	WF4104	142,30€	HO60RID WF7508	142,30€ 140,80€					WL4003 PW4023	195,10€ 66,70€
450	CRF450 RX	17-18	WF4104	142,30€	HO60RID WF7508	142,30€ 140,80€					WL4003 PW4015	195,10€ 66,70€
450	CRF450 RX	19-22	WF4104	142,30€	HO60RID WF7508	142,30€ 140,80€					WL4003 PW4023	195,10€ 66,70€
450	CRF450 X	05-05	HO25FID	142,30€	HO60RID WF7508	142,30€ 140,80€					WL4003 POW79	195,10€ 66,70€
450	CRF450 X	06-16	HO25FID	142,30€	HO60RID WF7508	142,30€ 140,80€					WL4003 POW79	195,10€ 66,70€
450	CRF450 X	17-18	WF4104	142,30€	HO60RID WF7508	142,30€ 140,80€					WL4003 PW4015	195,10€ 66,70€
450	CRF450 X	19-20	WF4104	142,30€	HO60RID WF7508	142,30€ 140,80€					WL4003 PW4023	195,10€ 66,70€
450	TRX450 Foreman	98-04										
450	TRX450 R	04-09	HO41FID	112,40€	HO53RID	112,40€						
450	TRX450 Sportrax	01-09	HO41FID	112,40€								
480	CR480 R	82-82										
480	CR480 R	83-83										
500	CR500 R	84-85										
500	CR500 R	86-86										
500	CR500 R	87-87										



Cyl.	Modèle	Années	sbs		sbs		sbs		sbs	
			PLAQUETTES AV	€ T.T.C.	PLAQUETTES AR	€ T.T.C.	DISQUE AV	€ T.T.C.	DISQUE AR	€ T.T.C.
HONDA										
500	CR500 R	88-88	603SI	28,40€	604SI	28,40€				
500	CR500 R	89-94	603SI	28,40€	604SI	28,40€				
500	CR500 R	95-01	694SI	28,40€	604SI	28,40€	5003	79,20€		
500	CR500 R	02-02	694SI	28,40€	604SI	28,40€				
500	TRX500 FA Foretrax, Foreman	00-04	02085	52,50€	02072	64,70€				
500	TRX500 FA Foretrax, Foreman	05-13	829ATS	28,40€	02046	64,70€				
500	XR500 R	81-82	02030	40,30€	02026	40,50€				
500	XR500 R	83-86	558HF	30,90€	02026	40,50€				
500	XR500 S	79-80	02031	48,50€	02026	40,50€				
600	XR600 R	85-87	558SI	28,40€	02013	24,10€				
600	XR600 R	88-90	603SI	28,40€	02013	24,10€				
600	XR600 R [FR]	91-92	603SI	28,40€	604SI	28,40€	5031	79,20€	5110	71,90€
600	XR600 R [FR]	93-00	694SI	28,40€	604SI	28,40€	5031	79,20€	5110	71,90€
650	TRX650 FA/FGA Rincon	03-05	02085	52,50€	813ATS	28,40€				
650	XR650 L [US]	93-99	694SI	28,40€	604SI	28,40€	5002	96,20€	5005	85,30€
650	XR650 L [US]	00-13	694SI	28,40€	604SI	28,40€	5002	96,20€	5005	85,30€
650	XR650 R	00-07	694SI	28,40€	604SI	28,40€	5031	79,20€		
680	TRX680 FA	06-09	829ATS 02085	28,40€ 52,50€	813ATS	28,40€				
HUSABERG										
125	TE125 2T	11-12					5066	96,20€	5049	84,10€
125	TE125 2T	13-14	671SI	28,40€	791SI	28,40€	5066	96,20€	5049	84,10€
125	TE125 2T	15-16	671SI	28,40€	791SI	28,40€				
250	FE250 4T	13-14	671SI	28,40€	791SI	28,40€	5066	96,20€	5049	84,10€
250	TE250 2T	11-14	671SI	28,40€	791SI	28,40€	5066	96,20€	5049	84,10€
300	TE300 2T	13-14	671SI	28,40€	791SI	28,40€	5066	96,20€	5049	84,10€
350	FE350 /E	96-96	671SI	28,40€	791SI	28,40€				
350	FE350 /E	97-99	671SI	28,40€	586SI	28,40€				
350	FE350 4T	13-14	671SI	28,40€	791SI	28,40€	5066	96,20€	5049	84,10€
350	TE350	14-14	671SI	28,40€	791SI	28,40€	5066	96,20€	5049	84,10€
390	FE390 Enduro	10-12	671SI	28,40€	791SI	28,40€	5066	96,20€	5049	84,10€
400	FC400	96-98	675SI	28,40€	675SI	28,40€				
400	FC400	99-00	675SI	28,40€	675SI	28,40€	5066	96,20€	5117	79,20€
400	FE400 /S /E	96-99	671SI	28,40€	675SI	28,40€				
400	FE400 /S /E	00-02	671SI	28,40€	675SI	28,40€	5066	96,20€		
400	FE400 /S /E	03-03	671RSI	39,80€	675SI	28,40€	5066	96,20€		
450	FC450	04-06	671RSI	39,80€	791RSI	39,80€				
450	FE450	09-14	671SI	28,40€	791SI	28,40€	5066	96,20€	5049	84,10€
450	FE450 E	04-08	671SI	28,40€	675SI	28,40€	5066	96,20€	5117	79,20€
450	FS450 E /C	03-08			675SI	28,40€	5066	96,20€	5117	79,20€
470	FC470	01-02	671SI	28,40€	675SI	28,40€	5066	96,20€	5117	79,20€
501	FC501	94-00	675SI	28,40€	675SI	28,40€				
501	FE501	13-14	671SI	28,40€	791SI	28,40€				
501	FE501 /S /E	00-04	671SI	28,40€	675SI	28,40€	5066	96,20€	5049	84,10€
501	TE 501	95-00	671SI	28,40€	586SI	28,40€				
550	FC550	01-06	671SI	28,40€	675SI	28,40€	5066	96,20€	5049	84,10€
550	FE550 /E	04-08	671SI	28,40€	675SI	28,40€	5066	96,20€	5049	84,10€
570	FE570 Enduro	09-12	671SI	28,40€	791SI	28,40€	5066	96,20€	5049	84,10€
600	FC600 (Motocross)	93-97	671SI	28,40€	675SI	28,40€				
600	FC600 (Motocross)	98-98	671RSI	39,80€	675RSI	39,90€				
600	FC600 (Motocross)	99-00	671RSI	39,80€	675RSI	39,90€	5066	96,20€	5049	84,10€

BRACING

			BRACING		BRACING		BRACING		BRACING			
Années			DISQUE AV WAVE	€ T.T.C.	DISQUE AR WAVE	€ T.T.C.	DISQUE AV ROND	€ T.T.C.	DISQUE AR ROND	€ T.T.C.	DISQUE 270mm OVERSIZE	€ T.T.C.
HONDA												
500	CR500 R	88-88					HO13FI	127,60€				
500	CR500 R	89-94					HO13FI	127,60€	HO02RI	99,20€		
500	CR500 R	95-01	HO25FID	142,30€					HO02RI	99,20€		
500	CR500 R	02-02										
500	TRX500 FA Foretrax, Foreman	00-04										
500	TRX500 FA Foretrax, Foreman	05-13										
500	XR500 R	81-82										
500	XR500 R	83-86					HO09RI	99,60€				
500	XR500 S	79-80										
600	XR600 R	85-87	HO09FID	142,20€								
600	XR600 R	88-90	HO09FID	142,20€								
600	XR600 R [FR]	91-92	HO09FID	142,20€	HO09RID	113,30€			HO09RI	99,60€		
600	XR600 R [FR]	93-00	HO09FID	142,20€	HO09RID	113,30€			HO09RI	99,60€		
650	TRX650 FA/FGA Rincon	03-05			HO22RID	140,80€	HO03FI	128,20€	HO22RI	144,00€		
650	XR650 L [US]	93-99			HO22RID	140,80€	HO03FI	128,20€	HO22RI	144,00€		
650	XR650 L [US]	00-13			HO13RID	141,70€	HO03FI	128,20€				
650	XR650 R	00-07	HO09FID	142,20€	HO13RID	141,70€						
680	TRX680 FA	06-09										
HUSABERG												
125	TE125 2T	11-12	KT02FID	142,30€	KT11RID WF4505	113,80€ 113,80€					WL4007 PW4008	195,10€ 65,80€
125	TE125 2T	13-14	KT02FID	142,30€	KT11RID WF4505	113,80€ 113,80€					WL4007 PW4008	195,10€ 65,80€
125	TE125 2T	15-16										
250	FE250 4T	13-14	KT02FID	142,30€	KT11RID WF4505	113,80€ 113,80€					WL4007 PW4008	195,10€ 65,80€
250	TE250 2T	11-14	KT02FID	142,30€	KT11RID WF4505	113,80€ 113,80€					WL4007 PW4008	195,10€ 65,80€
300	TE300 2T	13-14	KT02FID	142,30€	KT11RID WF4505	113,80€ 113,80€					WL4007 PW4008	195,10€ 65,80€
350	FE350 /E	96-96										
350	FE350 /E	97-99										
350	FE350 4T	13-14	KT02FID	142,30€	KT11RID WF4505	113,80€ 113,80€					WL4007 PW4008	195,10€ 65,80€
350	TE350	14-14	KT02FID	142,30€	KT11RID WF4505	113,80€ 113,80€					WL4007 PW4008	195,10€ 65,80€
390	FE390 Enduro	10-12	KT02FID	142,30€	KT11RID WF4505	113,80€ 113,80€					WL4007 PW4008	195,10€ 65,80€
400	FC400	96-98										
400	FC400	99-00	KT02FID	142,30€								
400	FE400 /S /E	96-99										
400	FE400 /S /E	00-02	KT02FID	142,30€							WL4007 POW68	195,10€ 60,10€
400	FE400 /S /E	03-03	KT02FID	142,30€							WL4007 POW68	195,10€ 60,10€
450	FC450	04-06										
450	FE450	09-14	KT02FID	142,30€	KT11RID WF4505	113,80€ 113,80€					WL4007 PW4008	195,10€ 65,80€
450	FE450 E	04-08	KT02FID	142,30€								
450	FS450 E /C	03-08	KT02FID	142,30€								
470	FC470	01-02	KT02FID	142,30€								
501	FC501	94-00										
501	FE501	13-14										
501	FE501 /S /E	00-04	KT02FID	142,30€	KT11RID WF4505	113,80€ 113,80€					WL4007 POW68	195,10€ 60,10€
501	TE 501	95-00										
550	FC550	01-06	KT02FID	142,30€	KT11RID WF4505	113,80€ 113,80€						
550	FE550 /E	04-08	KT02FID	142,30€	KT11RID WF4505	113,80€ 113,80€					WL4007 POW68	195,10€ 60,10€
570	FE570 Enduro	09-12	KT02FID	142,30€	KT11RID WF4505	113,80€ 113,80€					WL4007 PW4008	195,10€ 65,80€
600	FC600 (Motocross)	93-97										
600	FC600 (Motocross)	98-98										
600	FC600 (Motocross)	99-00	KT02FID	142,30€	KT11RID WF4505	113,80€ 113,80€						

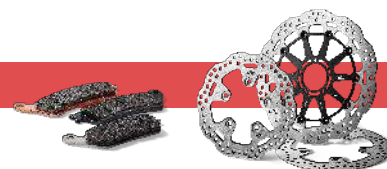

Cyl.	Modèle	Années	sbs		sbs		sbs		sbs	
			PLAQUETTES AV	€ T.T.C.	PLAQUETTES AR	€ T.T.C.	DISQUE AV	€ T.T.C.	DISQUE AR	€ T.T.C.
HUSABERG										
600	FC600 (Supermoto)	93-00	671SI	28,40€	675SI	28,40€				
600	FE600 /S /E	00-03	671SI	28,40€	675SI	28,40€	5066	96,20€	5049	84,10€
650	FE650 E	01-08	671SI	28,40€	675SI	28,40€				
650	FS650 C /E	01-05	671SI	28,40€	675SI	28,40€	5066	96,20€	5049	84,10€
650	FS650 C /E	06-08			675SI	28,40€				
HUSQVARNA										
50	CR Junior 50	06-06	803HF	22,60€						
50	CR Junior 50	07-14	803HF	22,60€						
50	Husky boy50	00-01	105HF	12,90€						
50	TC 50	17-22	794RSI	39,80€	794RSI	39,80€				
50	TC 50 Mini	19-22	794RSI	39,80€	794RSI	39,80€				
65	CR 65	12-14	783RSI	39,80€	872RSI	39,80€				
65	TC 65	17-22	783RSI	39,80€	783RSI	39,80€				
85	TC 85 14/17	16-20	885RSI	39,80€	872RSI	39,80€	5064	71,90€	5045	59,70€
85	TC 85 14/17	21-22	671RSI	39,80€	791RSI	39,80€	5064	71,90€	5049	84,10€
85	TC 85 16/19	14-20	885RSI	39,80€	872RSI	39,80€	5064	71,90€	5045	59,70€
85	TC 85 16/19	21-22	671RSI	39,80€	791RSI	39,80€	5064	71,90€	5049	84,10€
125	CR125	92-94	608SI	28,40€	692SI	28,40€				
125	CR125	95-04	671SI	28,40€	675SI	28,40€				
125	CR125	05-13	671RSI	39,80€	791RSI	39,80€	5109	59,70€		
125	Cross Country	91-91	608SI	28,40€	692SI	28,40€				
125	TC125 2T	13-13	671RSI	39,80€	791RSI	39,80€				
125	TC125 2T	14-22	671RSI	39,80€	791RSI	39,80€	5066	96,20€	5049	84,10€
125	TE125 2T	13-13	671SI	28,40€	791SI	28,40€				
125	TE125 2T	14-16	671SI	28,40€	791SI	28,40€	5066	96,20€	5049	84,10€
125	TE125 4T	10-10	671SI	28,40€	675SI	28,40€				
125	TE125 4T	11-13	671SI	28,40€	675SI	28,40€	5109	59,70€		
125	TE125 4T	14-14	671SI	28,40€	791SI	28,40€	5109	59,70€		
125	TX125 2T	17-19	671SI	28,40€	791SI	28,40€	5066	96,20€	5049	84,10€
125	WR125	92-94	608SI	28,40€	586SI	28,40€				
125	WR125	95-97	671RSI	39,80€	675RSI	39,90€				
125	WR125	98-06	671RSI	39,80€	675RSI	39,90€				
125	WR125	07-13	671RSI	39,80€	675RSI	39,90€				
125	WRE125	94-95	608SI	28,40€	586SI	28,40€				
125	WRE125	96-98	671RSI	39,80€	675RSI	39,90€				
125	WRE125	99-13	671RSI	39,80€	675RSI	39,90€				
150	TE150i	20-22	671SI	28,40€	791SI	28,40€	5066	96,20€	5049	84,10€
250	CR250	92-95	608SI	28,40€	692SI	28,40€				
250	CR250	96-99	671SI	28,40€	675SI	28,40€				
250	CR250	00-03	671SI	28,40€	675SI	28,40€				
250	CR250	04-04	671SI	28,40€	675SI	28,40€				
250	CR250	05-05	671RSI	39,80€	791RSI	39,80€	5109	59,70€		
250	FC 250	14-22	671RSI	39,80€	791RSI	39,80€	5066	96,20€	5049	84,10€
250	FE250	14-22	671RSI	39,80€	791RSI	39,80€	5066	96,20€	5049	84,10€
250	TC250	02-03	671RSI	39,80€	675RSI	39,90€	5109	59,70€		
250	TC250	04-07	671RSI	39,80€	791RSI	39,80€	5109	59,70€		
250	TC250	08-13	671RSI	39,80€	791RSI	39,80€	5109	59,70€		
250	TC250	14-22	671RSI	39,80€	791RSI	39,80€	5066	96,20€	5049	84,10€
250	TE250	02-03	671RSI	39,80€	675RSI	39,90€	5109	59,70€		
250	TE250	04-07	671RSI	39,80€	675RSI	39,90€	5109	59,70€		
250	TE250	08-09	671RSI	39,80€	675RSI	39,90€	5109	59,70€		
250	TE250	10-13	671RSI	39,80€	791RSI	39,80€	5109	59,70€		

BRACING

		BRACING			BRACING		BRACING		BRACING			
		Années	DISQUE AV WAVE	€ T.T.C.	DISQUE AR WAVE	€ T.T.C.	DISQUE AV ROND	€ T.T.C.	DISQUE AR ROND	€ T.T.C.	DISQUE 270mm OVERSIZE	€ T.T.C.
HUSABERG												
600	FC600 (Supermoto)	93-00	WK054L	297,70€	KT11RID WF4505	113,80€ 113,80€						
600	FE600 /S /E	00-03	KT02FID	142,30€	KT11RID WF4505	113,80€ 113,80€					WL4007 POW68	195,10€ 60,10€
650	FE650 E	01-08										
650	FS650 C /E	01-05	KT02FID	142,30€	KT11RID WF4505	113,80€ 113,80€						
650	FS650 C /E	06-08										
HUSQVARNA												
50	CR Junior 50	06-06	WK054L	297,70€								
50	CR Junior 50	07-14										
50	Husky boy50	00-01										
50	TC 50	17-22	WF4105	138,20€	WF4105	138,20€						
50	TC 50 Mini	19-22	WF4105	138,20€	WF4105	138,20€						
65	CR 65	12-14	KT06FID	113,30€								
65	TC 65	17-22	KT06FID	113,30€	KT06RID	113,30€						
85	TC 85 14/17	16-20	WF4102	142,20€	WF4509	113,30€						
85	TC 85 14/17	21-22	WF4102	142,20€	KT11RID WF4505	113,80€ 113,80€						
85	TC 85 16/19	14-20	WF4102	142,20€	WF4509	113,30€						
85	TC 85 16/19	21-22	WF4102	142,20€	KT11RID WF4505	113,80€ 113,80€						
125	CR125	92-94										
125	CR125	95-04	WL4005	195,10€								
125	CR125	05-13	WL4005	195,10€	WF4501	142,30€						
125	Cross Country	91-91										
125	TC125 2T	13-13										
125	TC125 2T	14-22	KT02FID	142,30€	KT11RID WF4505	113,80€ 113,80€					WL4007 PW4008	195,10€ 65,80€
125	TE125 2T	13-13										
125	TE125 2T	14-16	KT02FID	142,30€	KT11RID WF4505	113,80€ 113,80€					WL4007 PW4008	195,10€ 65,80€
125	TE125 4T	10-10										
125	TE125 4T	11-13										
125	TE125 4T	14-14										
125	TX125 2T	17-19	KT02FID	142,30€	KT11RID WF4505	113,80€ 113,80€					WL4007 PW4008	195,10€ 65,80€
125	WR125	92-94										
125	WR125	95-97										
125	WR125	98-06	WL4005	195,10€								
125	WR125	07-13	WL4005	195,10€	WF4501	142,30€						
125	WRE125	94-95										
125	WRE125	96-98										
125	WRE125	99-13	WL4005	195,10€								
150	TE150i	20-22	KT02FID	142,30€	KT11RID WF4505	113,80€ 113,80€					WL4007 PW4008	195,10€ 65,80€
250	CR250	92-95										
250	CR250	96-99										
250	CR250	00-03	WL4005	195,10€								
250	CR250	04-04	WL4005	195,10€	WF4501	142,30€						
250	CR250	05-05	WL4005	195,10€	WF4501	142,30€						
250	FC 250	14-22	KT02FID	142,30€	KT11RID WF4505	113,80€ 113,80€					WL4007 PW4008	195,10€ 65,80€
250	FE250	14-22	KT02FID	142,30€	KT11RID WF4505	113,80€ 113,80€					WL4007 PW4008	195,10€ 65,80€
250	TC250	02-03										
250	TC250	04-07	WL4005	195,10€								
250	TC250	08-13	WL4005	195,10€	WF4501	142,30€						
250	TC250	14-22	KT02FID	142,30€	KT11RID WF4505	113,80€ 113,80€					WL4007 PW4008	195,10€ 65,80€
250	TE250	02-03										
250	TE250	04-07	WL4005	195,10€								
250	TE250	08-09	WL4005	195,10€	WF4501	142,30€						
250	TE250	10-13	WL4005	195,10€	WF4501	142,30€						



Cyl.	Modèle	Années	sbs		sbs		sbs		sbs	
			PLAQUETTES AV	€ T.T.C.	PLAQUETTES AR	€ T.T.C.	DISQUE AV	€ T.T.C.	DISQUE AR	€ T.T.C.
HUSQVARNA										
250	TE250	14-17	671SI	28,40€	791SI	28,40€	5066	96,20€	5049	84,10€
250	TE250i	18-22	671SI	28,40€	791SI	28,40€	5066	96,20€	5049	84,10€
250	WR250	92-95	608SI	28,40€	692SI	28,40€				
250	WR250	96-98	671SI	28,40€	675SI	28,40€				
250	WR250	99-04	671SI	28,40€	675SI	28,40€				
250	WR250	05-13	671SI	28,40€	675SI	28,40€				
260	WR260	90-90	608SI	28,40€	692SI	28,40€				
300	TE300	14-17	671SI	28,40€	791SI	28,40€	5066	96,20€	5049	84,10€
300	TE300i	18-22	671SI	28,40€	791SI	28,40€	5066	96,20€	5049	84,10€
300	WR300	09-13	671SI	28,40€	675SI	28,40€	5109	59,70€		
310	TE310	08-13	671SI	28,40€	791SI	28,40€	5109	59,70€		
350	FC 350	14-22	671RSI	39,80€	791RSI	39,80€	5066	96,20€	5049	84,10€
350	FE 350	14-17	671SI	28,40€	791SI	28,40€	5066	96,20€	5049	84,10€
350	FE 350	18-22	671RSI	39,80€	791RSI	39,80€	5066	96,20€	5049	84,10€
350	TE350	90-95	608SI	28,40€	586SI	28,40€				
350	TE350	96-99	671SI	28,40€	675SI	28,40€				
360	WR360	92-99	671SI	28,40€	675SI	28,40€				
360	WR360	00-02	671SI	28,40€	675SI	28,40€				
400	TE400	98-00	671SI	28,40€	675SI	28,40€				
400	TE400	01-02	671SI	28,40€	675SI	28,40€	5109	59,70€		
400	WR-400	85-86	02118	60,70€	02116	52,50€				
400	WR-400	87-87	608SI	28,40€	02117	60,70€				
410	TE410	96-99	671SI	28,40€	675SI	28,40€				
410	TE410	00-01	671SI	28,40€	675SI	28,40€				
410	TE410	02-03	671SI	28,40€	675SI	28,40€				
410	TE410	04-13	671SI	28,40€	675SI	28,40€				
430	TE 430 Automatic	87-87	608SI	28,40€	02117	60,70€				
430	TE 430 Enduro	85-85	519SI	28,40€	02116	52,50€				
449	TC449	11-13	671SI	28,40€	791SI	28,40€	5109	59,70€		
449	TE449	11-13	671SI	28,40€	791SI	28,40€	5109	59,70€		
450	FC 450	14-18	671SI	28,40€	791SI	28,40€	5066	96,20€	5049	84,10€
450	FC 450	19-22	671RSI	39,80€	791RSI	39,80€	5066	96,20€	5049	84,10€
450	FE 450	14-22	671SI	28,40€	791SI	28,40€	5066	96,20€	5049	84,10€
450	FS 450	15-22	841RS	45,36€	791RSI	39,80€				
450	TC450	02-03	671SI	28,40€	675SI	28,40€	5109	59,70€		
450	TC450	04-04	671SI	28,40€	791SI	28,40€	5109	59,70€		
450	TC450	05-08	671SI	28,40€	791SI	28,40€	5109	59,70€		
450	TC450	09-10	671RSI	39,80€	791RSI	39,80€	5109	59,70€		
450	TC450	11-13	671SI	28,40€	791SI	28,40€				
450	TC450	14-14	671SI	28,40€	791SI	28,40€				
450	TE450	02-06	671SI	28,40€	675SI	28,40€	5109	59,70€		
450	TE450	07-10	671SI	28,40€	791SI	28,40€	5109	59,70€		
450	TE450	11-13	671SI	28,40€	791SI	28,40€				
500	CR 500	84-84	02118	60,70€	02116	52,50€				
500	CR 500	85-85	519SI	28,40€	02116	52,50€				
500	CR 500	86-86	519HF	22,60€	02117	60,70€				
500	XC 500	87-87	608SI	28,40€	02117	60,70€				
501	FE 501	14-22	671SI	28,40€	791SI	28,40€	5066	96,20€	5049	84,10€
510	510	87-89	519SI	28,40€	02117	60,70€				
510	SM510 Centennial	06-06	762081	74,50€	791SI	28,40€				
510	SM510 Centennial	07-07	762081	74,50€	791SI	28,40€				
510	SMR510	04-05	762081	74,50€	675SI	28,40€				
510	SMR510	06-12	762081	74,50€	791SI	28,40€				

BRAKING

				BRAKING		BRAKING		BRAKING		BRAKING		
		Années	DISQUE AV WAVE	€ T.T.C.	DISQUE AR WAVE	€ T.T.C.	DISQUE AV ROND	€ T.T.C.	DISQUE AR ROND	€ T.T.C.	DISQUE 270mm OVERSIZE	€ T.T.C.
HUSQVARNA												
250	TE250	14-17	KT02FID	142,30€	KT11RID WF4505	113,80€ 113,80€					WL4007 PW4008	195,10€ 65,80€
250	TE250i	18-22	KT02FID	142,30€	KT11RID WF4505	113,80€ 113,80€					WL4007 PW4008	195,10€ 65,80€
250	WR250	92-95										
250	WR250	96-98										
250	WR250	99-04	WL4005	195,10€								
250	WR250	05-13	WL4005	195,10€	WF4501	142,30€						
260	WR260	90-90										
300	TE300	14-17	KT02FID	142,30€	KT11RID WF4505	113,80€ 113,80€					WL4007 PW4008	195,10€ 65,80€
300	TE300i	18-22	KT02FID	142,30€	KT11RID WF4505	113,80€ 113,80€					WL4007 PW4008	195,10€ 65,80€
300	WR300	09-13	WL4005	195,10€	WF4501	142,30€						
310	TE310	08-13	WL4005	195,10€								
350	FC 350	14-22	KT02FID	142,30€	KT11RID WF4505	113,80€ 113,80€					WL4007 PW4008	195,10€ 65,80€
350	FE 350	14-17	KT02FID	142,30€	KT11RID WF4505	113,80€ 113,80€					WL4007 PW4008	195,10€ 65,80€
350	FE 350	18-22	KT02FID	142,30€	KT11RID WF4505	113,80€ 113,80€					WL4007 PW4008	195,10€ 65,80€
350	TE350	90-95										
350	TE350	96-99										
360	WR360	92-99										
360	WR360	00-02	WL4005	195,10€								
400	TE400	98-00										
400	TE400	01-02										
400	WR-400	85-86										
400	WR-400	87-87										
410	TE410	96-99										
410	TE410	00-01	WL4005	195,10€	WF4501	142,30€						
410	TE410	02-03	WL4005	195,10€								
410	TE410	04-13										
430	TE 430 Automatic	87-87	WL4005	195,10€								
430	TE 430 Enduro	85-85	WL4005	195,10€								
449	TC449	11-13	WL4005	195,10€	WF4501	142,30€						
449	TE449	11-13	WL4005	195,10€	WF4501	142,30€						
450	FC 450	14-18	KT02FID	142,30€	KT11RID WF4505	113,80€ 113,80€					WL4007 PW4008	195,10€ 65,80€
450	FC 450	19-22	KT02FID	142,30€	KT11RID WF4505	113,80€ 113,80€					WL4007 PW4008	195,10€ 65,80€
450	FE 450	14-22	KT02FID	142,30€	KT11RID WF4505	113,80€ 113,80€					WL4007 PW4008	195,10€ 65,80€
450	FS 450	15-22										
450	TC450	02-03	WL4005	195,10€								
450	TC450	04-04	WL4005	195,10€								
450	TC450	05-08	WL4005	195,10€	WF4501	142,30€						
450	TC450	09-10	WL4005	195,10€	WF4501	142,30€						
450	TC450	11-13	WL4005	195,10€								
450	TC450	14-14	KT02FID	142,30€	KT11RID WF4505	113,80€ 113,80€					WL4007 PW4008	195,10€ 65,80€
450	TE450	02-06	WL4005	195,10€								
450	TE450	07-10	WL4005	195,10€								
450	TE450	11-13	WL4005	195,10€								
500	CR 500	84-84										
500	CR 500	85-85										
500	CR 500	86-86										
500	XC 500	87-87										
501	FE 501	14-22	KT02FID	142,30€	KT11RID WF4505	113,80€ 113,80€					WL4007 PW4008	195,10€ 65,80€
510	510	87-89										
510	SM510 Centennial	06-06										
510	SM510 Centennial	07-07			WF4501	142,30€						
510	SMR510	04-05			WF4501	142,30€						
510	SMR510	06-12			WF4501	142,30€						



Cyl.	Modèle	Années	sbs		sbs		sbs		sbs	
			PLAQUETTES AV	€ T.T.C.	PLAQUETTES AR	€ T.T.C.	DISQUE AV	€ T.T.C.	DISQUE AR	€ T.T.C.
HUSQVARNA										
510	TC510	02-03	671SI	28,40€	675SI	28,40€	5109	59,70€		
510	TC510	04-10	671SI	28,40€	791SI	28,40€	5109	59,70€		
510	TC510	11-12	671SI	28,40€	791SI	28,40€				
510	TE510	88-89	519HF	22,60€	02117	60,70€				
510	TE510	90-91	608SI	28,40€	586SI	28,40€				
510	TE510	02-05	671SI	28,40€	675SI	28,40€	5109	59,70€		
510	TE510	06-06	671SI	28,40€	791SI	28,40€	5109	59,70€		
510	TE510	07-13	671SI	28,40€	675SI	28,40€	5109	59,70€		
510	TE510 Centennial	04-07	671SI	28,40€	675SI	28,40€				
570	TC570	01-03	671SI	28,40€	675SI	28,40€	5109	59,70€		
570	TC570	04-13	671SI	28,40€	675SI	28,40€	5109	59,70€		
570	TE570	01-04	671SI	28,40€	675SI	28,40€	5109	59,70€		
570	TE570	05-13	671SI	28,40€	675SI	28,40€	5109	59,70€		
610	TC610	92-95	608SI	28,40€	692SI	28,40€				
610	TC610	96-13	671SI	28,40€	675SI	28,40€				
610	TC610 Cross	91-91	608SI	28,40€	692SI	28,40€				
610	TE610	92-95	608SI	28,40€	692SI	28,40€				
610	TE610	96-09	671SI	28,40€	675SI	28,40€				
610	TE610 E	97-13	671SI	28,40€	675SI	28,40€				
610	TE610 i.e.	08-10	671SI	28,40€	675SI	28,40€				
630	TE630	10-12	671SI	28,40€	791SI	28,40€	5109	59,70€		
693	Enduro 701	16-22	674HS	44,40€	675LS	48,90€				
HYOSUNG										
450	TE450 Sport	07-09	536ATS	28,40€	649ATS	28,40€				
KAWASAKI										
50	KFX50 (KSF [US])	02-04	02101	29,90€	02101	29,90€				
60	KX60	83-99	02093	26,30€	02093	26,30€				
65	KX65	00-18	752SI	28,40€	536SI	28,40€				
65	KX65	19-22	752SI	28,40€	536SI	28,40€				
80	KX80	89-93	544SI	28,40€	592SI	28,40€	5283	75,50€		
80	KX80	94-96	544SI	28,40€	592SI	28,40€	5283	75,50€		
80	KX80	97-00	726RSI	39,90€	592RSI	39,80€	5283	75,50€	5269	54,80€
85	KX85	01-22	726RSI	39,90€	592RSI	39,80€	5283	75,50€	5269	54,80€
110	KLX110	02-21	02093	26,30€	02015	28,50€				
125	KDX125	88-94	544SI	28,40€	632SI	28,40€	5292	164,50€		
125	KLX125 C	10-16	611HF	33,50€	536HF	22,60€				
125	KLX125 D D-Tracker	10-14	611HF	33,50€	536HF	22,60€				
125	KX125	82-82	544SI	28,40€	02183	32,30€				
125	KX125	83-85	546SI	28,40€	02025	36,30€				
125	KX125	86-86	546SI	28,40€	586SI	28,40€				
125	KX125	87-88	602HF	33,50€	586SI	28,40€				
125	KX125	89-93	611SI	28,40€	632SI	28,40€	5292	164,50€		
125	KX125	94-94	694SI	28,40€	632SI	28,40€	5292	164,50€		
125	KX125	95-95	694SI	28,40€	604SI	28,40€	5292	164,50€		
125	KX125	96-02	694RSI	39,80€	604RSI	39,80€	5292	164,50€		
125	KX125	03-05	694RSI	39,80€	604RSI	39,80€				
125	KX125	06-08	694RSI	39,80€	604RSI	39,80€	5011	131,40€		
200	KDX200	92-92	546SI	28,40€	632SI	28,40€	5292	164,50€		
200	KDX200	93-93	611SI	28,40€	632SI	28,40€	5292	164,50€		
200	KDX200	94-99	694SI	28,40€	632SI	28,40€	5292	164,50€		
200	KDX200	00-06					5292	164,50€		
200	KLT 200	83-84	02015	28,50€	02040	44,40€				
220	KLF220 Bayou	88-03	02040	44,40€	02038	52,50€				
250	KDX250	91-96	611SI	28,40€	632SI	28,40€	5292	164,50€		
250	KDX250	97-97	694SI	28,40€	632SI	28,40€	5292	164,50€		
250	KFX250 Mojave (KSF [US])	87-04	591ATS	28,40€	592ATS	28,40€				
250	KLA 250	78-84	02040	44,40€	02016	44,40€				
250	KLF 250 Bayou 2WD	03-11	02040	44,40€	02016	44,40€				
250	KLT 250	83-85	02015	28,50€	02040	44,40€				

BRAKING

		BRAKING			BRAKING		BRAKING		BRAKING			
		Années	DISQUE AV WAVE	€ T.T.C.	DISQUE AR WAVE	€ T.T.C.	DISQUE AV ROND	€ T.T.C.	DISQUE AR ROND	€ T.T.C.	DISQUE 270mm OVERSIZE	€ T.T.C.
HUSQVARNA												
510	TC510	02-03	WL4005	195,10€								
510	TC510	04-10	WL4005	195,10€								
510	TC510	11-12	WL4005	195,10€								
510	TE510	88-89										
510	TE510	90-91										
510	TE510	02-05	WL4005	195,10€								
510	TE510	06-06	WL4005	195,10€	WF4501	142,30€						
510	TE510	07-13	WL4005	195,10€	WF4501	142,30€						
510	TE510 Centennial	04-07										
570	TC570	01-03	WL4005	195,10€	WF4501	142,30€						
570	TC570	04-13	WL4005	195,10€								
570	TE570	01-04	WL4005	195,10€	WF4501	142,30€						
570	TE570	05-13	WL4005	195,10€								
610	TC610	92-95										
610	TC610	96-13										
610	TC610 Cross	91-91										
610	TE610	92-95										
610	TE610	96-09										
610	TE610 E	97-13										
610	TE610 i.e.	08-10										
630	TE630	10-12										
693	Enduro 701	16-22										
HYOSUNG												
450	TE450 Sport	07-09										
KAWASAKI												
50	KFX50 (KSF [US])	02-04										
60	KX60	83-99										
65	KX65	00-18	KW32RID	113,30€	KW32RID	113,30€						
65	KX65	19-22										
80	KX80	89-93	KW18FID	113,80€								
80	KX80	94-96	KW18FID	113,80€	SZ26RID	107,30€						
80	KX80	97-00	KW18FID	113,80€	KW18RID	113,30€						
85	KX85	01-22	KW18FID	113,80€	KW18RID	113,30€						
110	KLX110	02-21										
125	KDX125	88-94										
125	KLX125 C	10-16										
125	KLX125 D D-Tracker	10-14										
125	KX125	82-82										
125	KX125	83-85										
125	KX125	86-86										
125	KX125	87-88										
125	KX125	89-93	KW01FID	141,70€	KW01RID	113,30€						
125	KX125	94-94	KW01FID	141,70€	KW01RID	113,30€						
125	KX125	95-95	KW01FID	141,70€	KW01RID	113,30€						
125	KX125	96-02	KW01FID	141,70€	KW01RID	113,30€						
125	KX125	03-05	KW35FID	141,70€	KW41RID	142,20€						
125	KX125	06-08	KW39FID	142,30€	KW41RID	142,20€					WL4008 POW02	195,10€ 66,70€
200	KDX200	92-92										
200	KDX200	93-93										
200	KDX200	94-99										
200	KDX200	00-06										
200	KLT 200	83-84										
220	KLF220 Bayou	88-03										
250	KDX250	91-96	KW01FID	141,70€								
250	KDX250	97-97	KW01FID	141,70€								
250	KFX250 Mojave (KSF [US])	87-04										
250	KLA 250	78-84										
250	KLF 250 Bayou 2WD	03-11										
250	KLT 250	83-85										



Cyl.	Modèle	Années	sbs		sbs		sbs		sbs	
			PLAQUETTES AV	€ T.T.C.	PLAQUETTES AR	€ T.T.C.	DISQUE AV	€ T.T.C.	DISQUE AR	€ T.T.C.
KAWASAKI										
250	KLX250 R	93-93	694SI	28,40€	632HF	30,90€				
250	KLX250 R	94-98	694SI	28,40€	604SI	28,40€				
250	KLX250 S /SF	09-17	611HF	33,50€	604HF	33,80€				
250	KSF Mojave	87-87	591SI	28,40€	592SI	28,40€				
250	KX250	82-82	544SI	28,40€	02183	32,30€				
250	KX250	83-85	546SI	28,40€	02183	32,30€				
250	KX250	86-86	546SI	28,40€	586SI	28,40€				
250	KX250	87-88	602HF	33,50€	586SI	28,40€	5292	164,50€		
250	KX250	89-93	611SI	28,40€	632SI	28,40€	5292	164,50€		
250	KX250	94-95	694SI	28,40€	632SI	28,40€	5292	164,50€		
250	KX250	96-02	694RSI	39,80€	604RSI	39,80€	5292	164,50€		
250	KX250	03-05	694RSI	39,80€	604RSI	39,80€				
250	KX250	06-08	694RSI	39,80€	604RSI	39,80€	5011	131,40€		
250	KX250 F	04-05	694RSI	39,80€	790RSI	39,80€			5106	79,20€
250	KX250 F	06-14	694RSI	39,80€	790RSI	39,80€	5011	131,40€	5106	79,20€
250	KX250 F	15-18	694RSI	39,80€	790RSI	39,80€	5112	131,40€	5106	79,20€
250	KX250 F - KX	19-19	694RSI	39,80€	790RSI	39,80€	5112	131,40€	5106	79,20€
250	KX250 F - KX	20-22	694RSI	39,80€	790RSI	39,80€	5112	131,40€	5106	79,20€
250	KX250X Enduro (KL)	22-22	694RSI	39,80€	790RSI	39,80€	5112	131,40€	5106	79,20€
250	KX250 F Tecate (quad)	87-88	591ATS	28,40€	592ATS	28,40€				
300	KEF300 Lakota	95-03	591ATS	28,40€	592ATS	28,40€				
300	KLF300 Bayou	86-87			02038	52,50€				
300	KLF300 Bayou	88-88	546ATS	28,40€	02038	52,50€				
300	KLF300 Bayou	89-07	611ATS 638ATS	28,40€ 28,40€	02197	60,70€				
300	KLX300 R	97-07	694SI	28,40€	604SI	28,40€	5292	164,50€		
300	KVF300 4x4	12-19	536ATS	28,40€	810ATS	28,40€				
360	KVF360 Prairie 2x4	03-09	536ATS	28,40€						
360	KVF360 Prairie 4x4	03-13	536ATS	28,40€						
400	KFX400 (KSF [US])	02-04	536ATS	28,40€	649ATS	28,40€				
400	KFX400 (KSF [US])	05-06	536ATS	28,40€	649ATS	28,40€				
400	KLF400 Bayou	93-99	611ATS 638ATS	28,40€ 28,40€	02197	60,70€				
400	KVF400 Prairie	97-98	536ATS	28,40€	02197	60,70€				
400	KVF400 Prairie 2x4	99-02	536ATS	28,40€						
400	KVF400 Prairie 4x4	99-02	536ATS	28,40€						
450	KFX450 R	07-14	801ATS 798ATS	28,40€ 28,40€	592ATS	28,40€				
450	KLX450 R	05-15	694SI	28,40€	790SI	28,40€	5011	131,40€	5106	79,20€
450	KX450 F	06-14	694RSI	39,80€	790RSI	39,80€	5011	131,40€	5106	79,20€
450	KX450 F	15-18	694RSI	39,80€	790RSI	39,80€	5112	131,40€	5106	79,20€
450	KX450 F - KX	19-22	694RSI	39,80€	790RSI	39,80€	5112	131,40€	5106	79,20€
450	KX450 X Enduro (KL)	22-22	694RSI	39,80€	790RSI	39,80€	5112	131,40€	5106	79,20€
500	KX500	84-85	546SI	28,40€	02183	32,30€				
500	KX500	86-86	546SI	28,40€	586SI	28,40€				
500	KX500	87-88	602HF	33,50€	586SI	28,40€				
500	KX500	89-93	611SI	28,40€	632SI	28,40€				
500	KX500	94-95	694SI	28,40€	632SI	28,40€				
500	KX500	96-98	694SI	28,40€	604SI	28,40€				
500	KX500	99-99	539HF	30,90€	540HF	30,90€				
500	KX500	00-04	694SI	28,40€	604SI	28,40€				
650	KFX650 V-Force	01-02	801ATS 798ATS	28,40€ 28,40€						
650	KLX650 C	93-95	694SI	28,40€	632SI	28,40€				
650	KLX650 R	93-95	694SI	28,40€	632SI	28,40€			5291	-
650	KLX650 R	96-01	694SI	28,40€	604SI	28,40€			5291	-
650	KVF650 Brute Force 4x4i	05-09	611ATS 638ATS	28,40€ 28,40€						
650	KVF650 Brute Force 4x4i	13-14	801ATS 798ATS	28,40€ 28,40€						

BRAKING

		BRAKING		BRAKING		BRAKING		BRAKING				
		Années	DISQUE AV WAVE	€ T.T.C.	DISQUE AR WAVE	€ T.T.C.	DISQUE AV ROND	€ T.T.C.	DISQUE AR ROND	€ T.T.C.	DISQUE 270mm OVERSIZE	€ T.T.C.
KAWASAKI												
250	KLX250 R	93-93										
250	KLX250 R	94-98										
250	KLX250 S /SF	09-17										
250	KSF Mojave	87-87										
250	KX250	82-82										
250	KX250	83-85										
250	KX250	86-86										
250	KX250	87-88	KW01FID	141,70€								
250	KX250	89-93	KW01FID	141,70€	KW01RID	113,30€						
250	KX250	94-95	KW01FID	141,70€	KW01RID	113,30€						
250	KX250	96-02	KW01FID	141,70€	KW01RID	113,30€						
250	KX250	03-05	KW35FID	141,70€	KW41RID	142,20€						
250	KX250	06-08	KW39FID	142,30€	KW41RID	142,20€					WL4008 POW02	195,10€ 66,70€
250	KX250 F	04-05	KW35FID	141,70€	KW41RID	142,20€						
250	KX250 F	06-14	KW39FID	142,30€	KW41RID	142,20€					WL4008 POW02	195,10€ 66,70€
250	KX250 F	15-18	WL4008	195,10€	KW41RID	142,20€						
250	KX250 F - KX	19-19	WL4008	195,10€	KW41RID	142,20€						
250	KX250 F - KX	20-22	WL4008	195,10€	WF4514	138,20€						
250	KX250X Enduro (KL)	22-22	WL4008	195,10€	WF4514	138,20€						
250	KX250 F Tecate (quad)	87-88										
300	KEF300 Lakota	95-03										
300	KLF300 Bayou	86-87										
300	KLF300 Bayou	88-88										
300	KLF300 Bayou	89-07										
300	KLX300 R	97-07	KW01FID	141,70€	KW01RID	113,30€						
300	KVF300 4x4	12-19										
360	KVF360 Prairie 2x4	03-09										
360	KVF360 Prairie 4x4	03-13										
400	KFX400 (KSF [US])	02-04	SZ16FID	112,00€	HO47RID	112,40€						
400	KFX400 (KSF [US])	05-06										
400	KLF400 Bayou	93-99										
400	KVF400 Prairie	97-98										
400	KVF400 Prairie 2x4	99-02										
400	KVF400 Prairie 4x4	99-02										
450	KFX450 R	07-14										
450	KLX450 R	05-15	KW39FID	142,30€	KW41RID	142,20€					WL4008 POW02	195,10€ 66,70€
450	KX450 F	06-14	KW39FID	142,30€	KW41RID	142,20€					WL4008 POW02	195,10€ 66,70€
450	KX450 F	15-18	WL4008	195,10€	KW41RID	142,20€						
450	KX450 F - KX	19-22	WL4008	195,10€	WF4514	138,20€						
450	KX450 X Enduro (KL)	22-22	WL4008	195,10€	WF4514	138,20€						
500	KX500	84-85										
500	KX500	86-86										
500	KX500	87-88										
500	KX500	89-93										
500	KX500	94-95			KW01RID	113,30€						
500	KX500	96-98			KW01RID	113,30€						
500	KX500	99-99			KW01RID	113,30€						
500	KX500	00-04			KW01RID	113,30€						
650	KFX650 V-Force	01-02										
650	KLX650 C	93-95										
650	KLX650 R	93-95			KW01RID	113,30€						
650	KLX650 R	96-01			KW01RID	113,30€						
650	KVF650 Brute Force 4x4i	05-09										
650	KVF650 Brute Force 4x4i	13-14										



Cyl.	Modèle	Années	sbs		sbs		sbs		sbs	
			PLAQUETTES AV	€ T.T.C.	PLAQUETTES AR	€ T.T.C.	DISQUE AV	€ T.T.C.	DISQUE AR	€ T.T.C.
KAWASAKI										
650	KVF650 Prairie	01-03	801ATS 798ATS	28,40€ 28,40€						
700	KFX700 V-Force	04-11	801ATS 798ATS	28,40€ 28,40€						
700	KSV700 V-Force	04-11	801ATS 798ATS	28,40€ 28,40€						
700	KVF700 Prairie	04-11	801ATS 798ATS	28,40€ 28,40€						
750	KVF750 Brute Force 4x4	05-20	611ATS 638ATS	28,40€ 28,40€						
800	TERYX KRF-KRT	14-14	611ATS 638ATS	28,40€ 28,40€						
KTM										
0	Freeride E-SM	15-17	885SI	28,40€	872SI	28,40€				
0	Freeride E-SX	15-17	885SI	28,40€	872SI	28,40€				
0	Freeride E-XC	15-21	885SI	28,40€	872SI	28,40€				
0	SX-E	19-22	794RSI	39,80€	794RSI	39,80€				
50	EXC50	96-01	652HF	22,60€	559HF	22,60€				
50	Mini Adventure 50	98-07	02074	24,10€	02074	24,10€				
50	Supermoto 50 SM	06-13	794SI	28,40€	794SI	28,40€				
50	SX50	03-03	794RSI	39,80€	02074	24,10€				
50	SX50	04-05	794RSI	39,80€	794RSI	39,80€				
50	SX50	06-13	794RSI	39,80€	794RSI	39,80€				
50	SX50	14-22	794RSI	39,80€	794RSI	39,80€				
50	SX50 Junior	06-08	794SI	28,40€	02074	24,10€				
50	SX50 Junior	09-15	794SI	28,40€	794SI	28,40€				
50	SX50 Mini	19-22	794RSI	39,80€	794RSI	39,80€				
50	SX50 Pro Junior LC	02-06	794SI	28,40€	02074	24,10€				
50	SX50 Pro Senior LC	02-03	794SI	28,40€	02074	24,10€				
50	SX50 Pro Senior LC	04-06	794SI	28,40€	794SI	28,40€				
50	SX50 Senior Adventure	03-07	794SI	28,40€	02074	24,10€				
60	SX60	98-01	559RSI	39,80€						
65	SX65	00-01	559RSI	39,80€	574SI	28,40€	5007	48,70€	5008	42,60€
65	SX65	02-03	783SI	28,40€	574SI	28,40€	5007	48,70€	5008	42,60€
65	SX65	04-06	783RSI	39,80€	794RSI	39,80€	5007	48,70€	5008	42,60€
65	SX65	07-08	783SI	28,40€	794SI	28,40€	5007	48,70€	5008	42,60€
65	SX65	09-22	783RSI	39,80€	783RSI	39,80€	5007	48,70€	5008	42,60€
80	MX80 (grandes roues)	86-90	583HF	29,04€	02122	40,30€				
80	MX80 (petites roues)	99-99	583HF	29,04€	02122	40,30€				
80	SX/MX80	91-91	583HF	29,04€						
85	SX85 (17"/14")	03-10	783RSI	39,80€	783RSI	39,80€	5009	71,90€	5010	48,70€
85	SX85 (17"/14")	11-11	783RSI	39,80€	872RSI	39,80€	5009	71,90€	5045	59,70€
85	SX85 (17"/14")	12-17	885RSI	39,80€	872RSI	39,80€	5009	71,90€	5045	59,70€
85	SX85 (17"/14")	18-20	885RSI	39,80€	872RSI	39,80€	5064	71,90€	5045	59,70€
85	SX85 (17"/14")	21-22	671RSI	39,80€	791RSI	39,80€	5064	71,90€	5049	84,10€
85	SX85 (19"/16")	03-10	783RSI	39,80€	783RSI	39,80€	5009	71,90€	5010	48,70€
85	SX85 (19"/16")	11-11	783RSI	39,80€	872RSI	39,80€	5009	71,90€	5010	48,70€
85	SX85 (19"/16")	12-12	885RSI	39,80€	872RSI	39,80€	5009	71,90€	5010	48,70€
85	SX85 (19"/16")	13-20	885RSI	39,80€	872RSI	39,80€	5064	71,90€	5045	59,70€
85	SX85 (19"/16")	21-22	671RSI	39,80€	791RSI	39,80€	5064	71,90€	5049	84,10€
125	EGS125	86-87	519HF	22,60€	519HF	22,60€				
125	EGS125	88-88	621HF	30,90€	621HF	30,90€				
125	EGS125	89-90	546SI	28,40€	586SI	28,40€				
125	EGS125	91-91	546SI	28,40€	692HF	33,50€				
125	EGS125	92-92	671SI	28,40€	586SI	28,40€				
125	EGS125	93-97	671SI	28,40€	586SI	28,40€	5066	96,20€	5049	84,10€
125	EGS125	98-99	671SI	28,40€	675SI	28,40€	5066	96,20€	5049	84,10€

BRAKING

		BRAKING		BRAKING		BRAKING		BRAKING				
		Années	DISQUE AV WAVE	€ T.T.C.	DISQUE AR WAVE	€ T.T.C.	DISQUE AV ROND	€ T.T.C.	DISQUE AR ROND	€ T.T.C.	DISQUE 270mm OVERSIZE	€ T.T.C.
KAWASAKI												
650	KVF650 Prairie	01-03										
700	KFX700 V-Force	04-11										
700	KSV700 V-Force	04-11										
700	KVF700 Prairie	04-11										
750	KVF750 Brute Force 4x4	05-20										
800	TERYX KRF-KRT	14-14										
KTM												
0	Freeride E-SM	15-17										
0	Freeride E-SX	15-17										
0	Freeride E-XC	15-21										
0	SX-E	19-22										
50	EXC50	96-01										
50	Mini Adventure 50	98-07										
50	Supermoto 50 SM	06-13										
50	SX50	03-03										
50	SX50	04-05										
50	SX50	06-13	WF4105	138,20€								
50	SX50	14-22	WF4105	138,20€	WF4105	138,20€						
50	SX50 Junior	06-08										
50	SX50 Junior	09-15										
50	SX50 Mini	19-22	WF4105	138,20€	WF4105	138,20€						
50	SX50 Pro Junior LC	02-06										
50	SX50 Pro Senior LC	02-03										
50	SX50 Pro Senior LC	04-06										
50	SX50 Senior Adventure	03-07										
60	SX60	98-01										
65	SX65	00-01	KT06FID	113,30€	KT06RID	113,30€						
65	SX65	02-03	KT06FID	113,30€	KT06RID	113,30€						
65	SX65	04-06	KT06FID	113,30€	KT06RID	113,30€						
65	SX65	07-08	KT06FID	113,30€	KT06RID	113,30€						
65	SX65	09-22	KT06FID	113,30€	KT06RID	113,30€						
80	MX80 (grandes roues)	86-90										
80	MX80 (petites roues)	99-99										
80	SX/MX80	91-91										
85	SX85 (17"/14")	03-10	KT07FID	113,30€	KT07RID	113,30€						
85	SX85 (17"/14")	11-11	KT07FID	113,30€	WF4509	113,30€						
85	SX85 (17"/14")	12-17	KT07FID	113,30€	WF4509	113,30€						
85	SX85 (17"/14")	18-20	WF4102	142,20€	WF4509	113,30€						
85	SX85 (17"/14")	21-22	WF4102	142,20€	KT11RID WF4505	113,80€ 113,80€						
85	SX85 (19"/16")	03-10	KT07FID	113,30€	KT07RID	113,30€						
85	SX85 (19"/16")	11-11	KT07FID	113,30€	KT07RID	113,30€						
85	SX85 (19"/16")	12-12	KT07FID	113,30€	KT07RID	113,30€						
85	SX85 (19"/16")	13-20	WF4102	142,20€	WF4509	113,30€						
85	SX85 (19"/16")	21-22	WF4102	142,20€	KT11RID WF4505	113,80€ 113,80€						
125	EGS125	86-87										
125	EGS125	88-88				KT11RID WF4505	113,80€ 113,80€					
125	EGS125	89-90				KT11RID WF4505	113,80€ 113,80€					
125	EGS125	91-91				KT11RID WF4505	113,80€ 113,80€					
125	EGS125	92-92				KT11RID WF4505	113,80€ 113,80€					
125	EGS125	93-97	KT02FID	142,30€	KT11RID WF4505	113,80€ 113,80€						
125	EGS125	98-99	KT02FID	142,30€	KT11RID WF4505	113,80€ 113,80€						

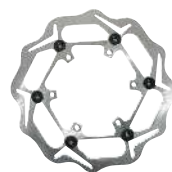

Cyl.	Modèle	Années	sbs		sbs		sbs		sbs	
			PLAQUETTES AV	€ T.T.C.	PLAQUETTES AR	€ T.T.C.	DISQUE AV	€ T.T.C.	DISQUE AR	€ T.T.C.
KTM										
125	EXC125 Enduro	95-99	671SI	28,40€	675SI	28,40€	5066	96,20€	5049	84,10€
125	EXC125 Enduro	00-03	671SI	28,40€	675SI	28,40€	5066	96,20€	5049	84,10€
125	EXC125 Enduro	04-09	671SI	28,40€	791SI	28,40€	5066	96,20€	5049	84,10€
125	EXC125 Enduro	10-18	671SI	28,40€	791SI	28,40€	5066	96,20€	5049	84,10€
125	EXE125 Enduro	00-01	671HS	44,40€	675LS	48,90€	5066	96,20€	5049	84,10€
125	LC 2, 125	98-98	671SI	28,40€	675SI	28,40€				
125	MX125	85-85	519HF	22,60€	02122	40,30€				
125	MX125	86-87	519HF	22,60€	519HF	22,60€				
125	MX125	88-88	621HF	30,90€	621HF	30,90€				
125	MX125	89-91	546SI	28,40€	692SI	28,40€				
125	MX125	92-92	671RSI	39,80€	692SI	28,40€	5066	96,20€	5049	84,10€
125	MX125	93-94	671RSI	39,80€	692RSI	39,80€	5066	96,20€	5049	84,10€
125	SX125	93-93	671RSI	39,80€	692RSI	39,80€	5066	96,20€	5049	84,10€
125	SX125	94-94	671SI	28,40€	675SI	28,40€	5066	96,20€	5049	84,10€
125	SX125	95-03	671RSI	39,80€	675RSI	39,90€	5066	96,20€	5049	84,10€
125	SX125	04-08	671RSI	39,80€	791RSI	39,80€	5066	96,20€	5049	84,10€
125	SX125	09-22	671RSI	39,80€	791RSI	39,80€	5066	96,20€	5049	84,10€
125	XC125 W Enduro	19-19	671RSI	39,80€	791RSI	39,80€	5066	96,20€	5049	84,10€
150	EXC150 TPI Enduro	20-22	671SI	28,40€	791SI	28,40€	5066	96,20€	5049	84,10€
150	SX144	07-08	671RSI	39,80€	791RSI	39,80€	5066	96,20€	5049	84,10€
150	SX150	09-22	671RSI	39,80€	791RSI	39,80€	5066	96,20€	5049	84,10€
200	EGS200	98-99	671SI	28,40€	675SI	28,40€				
200	EXC200 Enduro	98-99	671SI	28,40€	675SI	28,40€	5066	96,20€	5049	84,10€
200	EXC200 Enduro	00-03	671SI	28,40€	675SI	28,40€	5066	96,20€	5049	84,10€
200	EXC200 Enduro	04-09	671SI	28,40€	791SI	28,40€	5066	96,20€	5049	84,10€
200	EXC200 Enduro	10-16	671SI	28,40€	791SI	28,40€	5066	96,20€	5049	84,10€
200	SX200	00-01	671SI	28,40€	791SI	28,40€	5066	96,20€	5049	84,10€
200	SX200	02-02	671RSI	39,80€	675RSI	39,90€	5066	96,20€	5049	84,10€
200	SX200	03-03	671RSI	39,80€	675RSI	39,90€	5066	96,20€	5049	84,10€
200	SX200	04-06	671RSI	39,80€	791RSI	39,80€	5066	96,20€	5049	84,10€
250	EGS250	92-93	671SI	28,40€	692SI	28,40€	5066	96,20€	5049	84,10€
250	EGS250	94-99	671SI	28,40€	675SI	28,40€	5066	96,20€	5049	84,10€
250	EXC250 Enduro	95-99	671SI	28,40€	675SI	28,40€	5066	96,20€	5049	84,10€
250	EXC250 Enduro	00-03	671SI	28,40€	675SI	28,40€	5066	96,20€	5049	84,10€
250	EXC250 Enduro	04-09	671SI	28,40€	791SI	28,40€	5066	96,20€	5049	84,10€
250	EXC250 Enduro	10-17	671SI	28,40€	791SI	28,40€	5066	96,20€	5049	84,10€
250	EXC250 Racing	02-03	671SI	28,40€	675SI	28,40€	5066	96,20€	5049	84,10€
250	EXC250 Racing	04-09	671SI	28,40€	791SI	28,40€	5066	96,20€	5049	84,10€
250	EXC250 Racing	10-15	671SI	28,40€	791SI	28,40€	5066	96,20€	5049	84,10€
250	EXC250 TPI Enduro	18-22	671SI	28,40€	791SI	28,40€	5066	96,20€	5049	84,10€

BRAKING

		BRAKING			BRAKING		BRAKING		BRAKING			
		Années	DISQUE AV WAVE	€ T.T.C.	DISQUE AR WAVE	€ T.T.C.	DISQUE AV ROND	€ T.T.C.	DISQUE AR ROND	€ T.T.C.	DISQUE 270mm OVERSIZE	€ T.T.C.
KTM												
125	EXC125 Enduro	95-99	KT02FID	142,30€	KT11RID WF4505	113,80€ 113,80€						
125	EXC125 Enduro	00-03	KT02FID	142,30€	KT11RID WF4505	113,80€ 113,80€					WL4007 POW68	195,10€ 60,10€
125	EXC125 Enduro	04-09	KT02FID	142,30€	KT11RID WF4505	113,80€ 113,80€					WL4007 POW68	195,10€ 60,10€
125	EXC125 Enduro	10-18	KT02FID	142,30€	KT11RID WF4505	113,80€ 113,80€					WL4007 PW4008	195,10€ 65,80€
125	EXE125 Enduro	00-01	KT02FID	142,30€	KT11RID WF4505	113,80€ 113,80€						
125	LC 2, 125	98-98										
125	MX125	85-85										
125	MX125	86-87										
125	MX125	88-88			KT11RID WF4505	113,80€ 113,80€						
125	MX125	89-91			KT11RID WF4505	113,80€ 113,80€						
125	MX125	92-92	KT02FID	142,30€	KT11RID WF4505	113,80€ 113,80€						
125	MX125	93-94	KT02FID	142,30€	KT11RID WF4505	113,80€ 113,80€						
125	SX125	93-93	KT02FID	142,30€	KT11RID WF4505	113,80€ 113,80€					WL4007 POW68	195,10€ 60,10€
125	SX125	94-94	KT02FID	142,30€	KT11RID WF4505	113,80€ 113,80€					WL4007 POW68	195,10€ 60,10€
125	SX125	95-03	KT02FID	142,30€	KT11RID WF4505	113,80€ 113,80€					WL4007 POW68	195,10€ 60,10€
125	SX125	04-08	KT02FID	142,30€	KT11RID WF4505	113,80€ 113,80€					WL4007 POW68	195,10€ 60,10€
125	SX125	09-22	KT02FID	142,30€	KT11RID WF4505	113,80€ 113,80€					WL4007 PW4008	195,10€ 65,80€
125	XC125 W Enduro	19-19	KT02FID	142,30€	KT11RID WF4505	113,80€ 113,80€					WL4007 PW4008	195,10€ 65,80€
150	EXC150 TPI Enduro	20-22	KT02FID	142,30€	KT11RID WF4505	113,80€ 113,80€					WL4007 PW4008	195,10€ 65,80€
150	SX144	07-08	KT02FID	142,30€	KT11RID WF4505	113,80€ 113,80€					WL4007 POW68	195,10€ 60,10€
150	SX150	09-22	KT02FID	142,30€	KT11RID WF4505	113,80€ 113,80€					WL4007 PW4008	195,10€ 65,80€
200	EGS200	98-99										
200	EXC200 Enduro	98-99	KT02FID	142,30€	KT11RID WF4505	113,80€ 113,80€						
200	EXC200 Enduro	00-03	KT02FID	142,30€	KT11RID WF4505	113,80€ 113,80€					WL4007 POW68	195,10€ 60,10€
200	EXC200 Enduro	04-09	KT02FID	142,30€	KT11RID WF4505	113,80€ 113,80€					WL4007 POW68	195,10€ 60,10€
200	EXC200 Enduro	10-16	KT02FID	142,30€	KT11RID WF4505	113,80€ 113,80€					WL4007 PW4008	195,10€ 65,80€
200	SX200	00-01	KT02FID	142,30€	KT11RID WF4505	113,80€ 113,80€						
200	SX200	02-02	KT02FID	142,30€	KT11RID WF4505	113,80€ 113,80€						
200	SX200	03-03	KT02FID	142,30€	KT11RID WF4505	113,80€ 113,80€					WL4007 POW68	195,10€ 60,10€
200	SX200	04-06	KT02FID	142,30€	KT11RID WF4505	113,80€ 113,80€					WL4007 POW68	195,10€ 60,10€
250	EGS250	92-93	KT02FID	142,30€	KT11RID WF4505	113,80€ 113,80€						
250	EGS250	94-99	KT02FID	142,30€	KT11RID WF4505	113,80€ 113,80€						
250	EXC250 Enduro	95-99	KT02FID	142,30€	KT11RID WF4505	113,80€ 113,80€						
250	EXC250 Enduro	00-03	KT02FID	142,30€	KT11RID WF4505	113,80€ 113,80€					WL4007 POW68	195,10€ 60,10€
250	EXC250 Enduro	04-09	KT02FID	142,30€	KT11RID WF4505	113,80€ 113,80€					WL4007 POW68	195,10€ 60,10€
250	EXC250 Enduro	10-17	KT02FID	142,30€	KT11RID WF4505	113,80€ 113,80€					WL4007 PW4008	195,10€ 65,80€
250	EXC250 Racing	02-03	KT02FID	142,30€	KT11RID WF4505	113,80€ 113,80€					WL4007 POW68	195,10€ 60,10€
250	EXC250 Racing	04-09	KT02FID	142,30€	KT11RID WF4505	113,80€ 113,80€					WL4007 POW68	195,10€ 60,10€
250	EXC250 Racing	10-15	KT02FID	142,30€	KT11RID WF4505	113,80€ 113,80€					WL4007 PW4008	195,10€ 65,80€
250	EXC250 TPI Enduro	18-22	KT02FID	142,30€	KT11RID WF4505	113,80€ 113,80€					WL4007 PW4008	195,10€ 65,80€

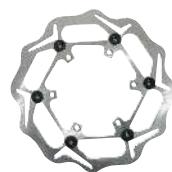

Cyl.	Modèle	Années	sbs		sbs		sbs		sbs	
			PLAQUETTES AV	€ T.T.C.	PLAQUETTES AR	€ T.T.C.	DISQUE AV	€ T.T.C.	DISQUE AR	€ T.T.C.
KTM										
250	EXC250-F Enduro	07-09	671SI	28,40€	791SI	28,40€	5066	96,20€	5049	84,10€
250	EXC250-F Enduro	10-22	671SI	28,40€	791SI	28,40€	5066	96,20€	5049	84,10€
250	EXE250 Enduro	04-07	671SI	28,40€	791SI	28,40€	5066	96,20€	5049	84,10€
250	EXE250 Enduro	08-14	671SI	28,40€	791SI	28,40€	5066	96,20€	5049	84,10€
250	Freeride	13-17	885SI	28,40€	872SI	28,40€	5054	164,50€	5045	59,70€
250	Freeride F	18-20	885SI	28,40€	872SI	28,40€	5054	164,50€	5045	59,70€
250	MX250	90-91	546SI	28,40€	692HF	33,50€				
250	MX250	92-93	671SI	28,40€	692SI	28,40€	5066	96,20€	5049	84,10€
250	MX250	94-94	671SI	28,40€	675SI	28,40€	5066	96,20€	5049	84,10€
250	SX250	95-99	671SI	28,40€	675SI	28,40€	5066	96,20€	5049	84,10€
250	SX250	00-00	671SI	28,40€	675SI	28,40€	5066	96,20€	5049	84,10€
250	SX250	01-02	671RSI	39,80€	675RSI	39,90€	5066	96,20€	5049	84,10€
250	SX250	03-03	671RSI	39,80€	791RSI	39,80€	5066	96,20€	5049	84,10€
250	SX250 2T	04-08	671RSI	39,80€	791RSI	39,80€	5066	96,20€	5049	84,10€
250	SX250 2T	09-22	671RSI	39,80€	791RSI	39,80€	5066	96,20€	5049	84,10€
250	SX250-F	05-08	671RSI	39,80€	791RSI	39,80€	5066	96,20€	5049	84,10€
250	SX250-F	09-22	671RSI	39,80€	791RSI	39,80€	5066	96,20€	5049	84,10€
300	EGS300	92-92	621HF	30,90€	621HF	30,90€	5066	96,20€	5049	84,10€
300	EGS300	93-93	671SI	28,40€	586SI	28,40€	5066	96,20€	5049	84,10€
300	EGS300	94-97	671SI	28,40€	675SI	28,40€	5066	96,20€	5049	84,10€
300	EGS300	98-99	671SI	28,40€	586SI	28,40€	5066	96,20€	5049	84,10€
300	EXC300 Enduro	94-96	671SI	28,40€	586SI	28,40€	5066	96,20€	5049	84,10€
300	EXC300 Enduro	97-98	671SI	28,40€	586SI	28,40€	5066	96,20€	5049	84,10€
300	EXC300 Enduro	99-03	671SI	28,40€	675SI	28,40€	5066	96,20€	5049	84,10€
300	EXC300 Enduro	04-09	671SI	28,40€	791SI	28,40€	5066	96,20€	5049	84,10€
300	EXC300 Enduro	10-17	671SI	28,40€	791SI	28,40€	5066	96,20€	5049	84,10€
300	EXC300 TPI Enduro	18-22	671SI	28,40€	791SI	28,40€	5066	96,20€	5049	84,10€
300	SX300	93-93	671SI	28,40€	586SI	28,40€	5066	96,20€	5049	84,10€
300	SX300	94-95	671SI	28,40€	675SI	28,40€	5066	96,20€	5049	84,10€
350	EXC350-F	12-22	671SI	28,40€	791SI	28,40€	5066	96,20€	5049	84,10€
350	Freeride 350	12-17	885SI	28,40€	872SI	28,40€	5054	164,50€	5045	59,70€
350	LC4 350	14-14	546SI	28,40€	586SI	28,40€				
350	MX350	87-87	601HF	30,90€	601HF	30,90€				
350	MX350	88-88	621HF	30,90€	621HF	30,90€				
350	SX350-F	11-22	671RSI	39,80€	791RSI	39,80€	5066	96,20€	5049	84,10€
360	EGS360	96-97	671SI	28,40€	675SI	28,40€				
360	EXC360	96-97	671SI	28,40€	675SI	28,40€	5066	96,20€	5049	84,10€
360	SX360	96-98	671SI	28,40€	675SI	28,40€	5066	96,20€	5049	84,10€
380	EGS380	98-99	671SI	28,40€	675SI	28,40€	5066	96,20€	5049	84,10€
380	EXC380	98-02	671SI	28,40€	675SI	28,40€	5066	96,20€	5049	84,10€
380	SX380	98-02	671SI	28,40€	675SI	28,40€	5066	96,20€	5049	84,10€

BRAKING

		BRAKING		BRAKING		BRAKING		BRAKING				
		Années	DISQUE AV WAVE	€ T.T.C.	DISQUE AR WAVE	€ T.T.C.	DISQUE AV ROND	€ T.T.C.	DISQUE AR ROND	€ T.T.C.	DISQUE 270mm OVERSIZE	€ T.T.C.
KTM												
250	EXC250-F Enduro	07-09	KT02FID	142,30€	KT11RID WF4505	113,80€ 113,80€					WL4007 POW68	195,10€ 60,10€
250	EXC250-F Enduro	10-22	KT02FID	142,30€	KT11RID WF4505	113,80€ 113,80€					WL4007 PW4008	195,10€ 65,80€
250	EXE250 Enduro	04-07	KT02FID	142,30€	KT11RID WF4505	113,80€ 113,80€						
250	EXE250 Enduro	08-14	KT02FID	142,30€	KT11RID WF4505	113,80€ 113,80€					WL4007 PW4008	195,10€ 65,80€
250	Freeride	13-17			WF4509	113,30€						
250	Freeride F	18-20			WF4509	113,30€						
250	MX250	90-91			KT11RID WF4505	113,80€ 113,80€						
250	MX250	92-93	KT02FID	142,30€	KT11RID WF4505	113,80€ 113,80€						
250	MX250	94-94	KT02FID	142,30€	KT11RID WF4505	113,80€ 113,80€						
250	SX250	95-99	KT02FID	142,30€	KT11RID WF4505	113,80€ 113,80€						
250	SX250	00-00	KT02FID	142,30€	KT11RID WF4505	113,80€ 113,80€					WL4007 POW68	195,10€ 60,10€
250	SX250	01-02	KT02FID	142,30€	KT11RID WF4505	113,80€ 113,80€					WL4007 POW68	195,10€ 60,10€
250	SX250	03-03	KT02FID	142,30€	KT11RID WF4505	113,80€ 113,80€					WL4007 POW68	195,10€ 60,10€
250	SX250 2T	04-08	KT02FID	142,30€	KT11RID WF4505	113,80€ 113,80€					WL4007 POW68	195,10€ 60,10€
250	SX250 2T	09-22	KT02FID	142,30€	KT11RID WF4505	113,80€ 113,80€					WL4007 PW4008	195,10€ 65,80€
250	SX250-F	05-08	KT02FID	142,30€	KT11RID WF4505	113,80€ 113,80€					WL4007 POW68	195,10€ 60,10€
250	SX250-F	09-22	KT02FID	142,30€	KT11RID WF4505	113,80€ 113,80€					WL4007 PW4008	195,10€ 65,80€
300	EGS300	92-92	KT02FID	142,30€	KT11RID WF4505	113,80€ 113,80€						
300	EGS300	93-93	KT02FID	142,30€	KT11RID WF4505	113,80€ 113,80€						
300	EGS300	94-97	KT02FID	142,30€	KT11RID WF4505	113,80€ 113,80€						
300	EGS300	98-99	KT02FID	142,30€	KT11RID WF4505	113,80€ 113,80€						
300	EXC300 Enduro	94-96	KT02FID	142,30€	KT11RID WF4505	113,80€ 113,80€						
300	EXC300 Enduro	97-98	KT02FID	142,30€	KT11RID WF4505	113,80€ 113,80€					WL4007 POW68	195,10€ 60,10€
300	EXC300 Enduro	99-03	KT02FID	142,30€	KT11RID WF4505	113,80€ 113,80€					WL4007 POW68	195,10€ 60,10€
300	EXC300 Enduro	04-09	KT02FID	142,30€	KT11RID WF4505	113,80€ 113,80€					WL4007 POW68	195,10€ 60,10€
300	EXC300 Enduro	10-17	KT02FID	142,30€	KT11RID WF4505	113,80€ 113,80€					WL4007 PW4008	195,10€ 65,80€
300	EXC300 TPI Enduro	18-22	KT02FID	142,30€	KT11RID WF4505	113,80€ 113,80€					WL4007 PW4008	195,10€ 65,80€
300	SX300	93-93	KT02FID	142,30€	KT11RID WF4505	113,80€ 113,80€						
300	SX300	94-95	KT02FID	142,30€	KT11RID WF4505	113,80€ 113,80€						
350	EXC350-F	12-22	KT02FID	142,30€	KT11RID WF4505	113,80€ 113,80€					WL4007 PW4008	195,10€ 65,80€
350	Freeride 350	12-17			WF4509	113,30€						
350	LC4 350	14-14										
350	MX350	87-87										
350	MX350	88-88										
350	SX350-F	11-22	KT02FID	142,30€	KT11RID WF4505	113,80€ 113,80€					WL4007 PW4008	195,10€ 65,80€
360	EGS360	96-97										
360	EXC360	96-97	KT02FID	142,30€	KT11RID WF4505	113,80€ 113,80€						
360	SX360	96-98	KT02FID	142,30€	KT11RID WF4505	113,80€ 113,80€						
380	EGS380	98-99	KT02FID	142,30€	KT11RID WF4505	113,80€ 113,80€						
380	EXC380	98-02	KT02FID	142,30€	KT11RID WF4505	113,80€ 113,80€						
380	SX380	98-02	KT02FID	142,30€	KT11RID WF4505	113,80€ 113,80€						

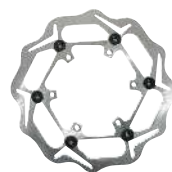

Cyl.	Modèle	Années	sbs		sbs		sbs		sbs	
			PLAQUETTES AV	€ T.T.C.	PLAQUETTES AR	€ T.T.C.	DISQUE AV	€ T.T.C.	DISQUE AR	€ T.T.C.
KTM										
380	XC380	98-99	671SI	28,40€	675SI	28,40€	5066	96,20€	5049	84,10€
400	EGS400 LC4	93-98	671SI	28,40€	586SI	28,40€	5013	140,10€		
400	EGS400 LC4 LSE	97-98	671SI	28,40€	675SI	28,40€	5013	140,10€		
400	EGS400 LC4-E	99-99	671SI	28,40€	675SI	28,40€	5013	140,10€		
400	EGS400 LC4-E 4T	01-01	671SI	28,40€	675SI	28,40€	5013	140,10€		
400	EXC400	00-03	671SI	28,40€	675SI	28,40€	5066	96,20€	5049	84,10€
400	EXC400	04-09	671SI	28,40€	791SI	28,40€	5066	96,20€	5049	84,10€
400	EXC400	10-14	671SI	28,40€	791SI	28,40€	5066	96,20€	5049	84,10€
400	MXC400	00-02	671SI	28,40€	675SI	28,40€	5066	96,20€	5049	84,10€
400	SC400	99-00	671SI	28,40€	675SI	28,40€	5066	96,20€	5049	84,10€
400	SX400 Enduro	00-02	671SI	28,40€	675SI	28,40€	5066	96,20€	5049	84,10€
400	SX400 Racing	00-00	671RSI	39,80€	675RSI	39,90€	5066	96,20€	5049	84,10€
400	SXC400 Tiainen Replica	99-00	671SI	28,40€	675SI	28,40€	5066	96,20€	5049	84,10€
440	EXC440	94-95	671SI	28,40€	675SI	28,40€				
440	SX440	94-95	671SI	28,40€	675SI	28,40€				
450	EXC450-F	03-09	671SI	28,40€	791SI	28,40€	5066	96,20€	5049	84,10€
450	EXC450-F	10-22	671SI	28,40€	791SI	28,40€	5066	96,20€	5049	84,10€
450	EXC450-R	02-09	671SI	28,40€	791SI	28,40€	5066	96,20€	5049	84,10€
450	EXC450-R	10-16	671SI	28,40€	791SI	28,40€	5066	96,20€	5049	84,10€
450	MXC450	03-06	671SI	28,40€	791SI	28,40€	5066	96,20€	5049	84,10€
450	RFR Rallye Factory Replica	11-14	674SI	28,40€	675SI	28,40€				
450	SC450 F	08-13	671SI	28,40€	791SI	28,40€				
450	SMR450	04-06	842RSI	39,90€	791RSI	39,80€			5049	84,10€
450	SMR450	07-12	843RSI	39,90€	791RSI	39,80€			5049	84,10€
450	SMR450	13-21	841RS 841081	45,36€ 48,40€	791RSI	39,80€			5049	84,10€
450	SX450 ATV	08-13	866ATS	28,40€	867ATS	28,40€				
450	SX450 Racing	03-06	671SI	28,40€	791SI	28,40€	5066	96,20€	5049	84,10€
450	SX450 Racing	15-15	671RSI	39,80€	791RSI	39,80€	5066	96,20€	5049	84,10€
450	SX450-F	03-08	671RSI	39,80€	791RSI	39,80€	5066	96,20€	5049	84,10€
450	SX450-F	09-22	671RSI	39,80€	791RSI	39,80€	5066	96,20€	5049	84,10€
450	SXS450-F	07-07	671RSI	39,80€	791RSI	39,80€	5066	96,20€	5049	84,10€
450	SXS450-F	08-08	671RSI	39,80€	791RSI	39,80€	5066	96,20€	5049	84,10€
450	XC450 ATV	08-13	866ATS	28,40€	867ATS	28,40€			5049	84,10€
450	XC450-F	07-07	671RSI	39,80€	791RSI	39,80€			5049	84,10€
450	XC450-F	08-13	671SI	28,40€	791SI	28,40€	5066	96,20€	5049	84,10€
450	XC450-W /WR	08-13	671RSI	39,80€	791RSI	39,80€	5066	96,20€	5049	84,10€
500	EXC500-F	12-22	671SI	28,40€	791SI	28,40€	5066	96,20€	5049	84,10€
500	GS500 2T	82-84	519SI	28,40€	02121	64,70€				
500	GS500 4T	82-84	519SI	28,40€	02121	64,70€				
500	GS500 K4 Enduro 4T	82-84	519SI	28,40€	02121	64,70€				
500	MX500	88-88	621HF	30,90€	621HF	30,90€			5049	84,10€
500	MX500	89-91	546SI	28,40€	692SI	28,40€			5049	84,10€
500	MX500	92-93	671SI	28,40€	692SI	28,40€	5066	96,20€	5049	84,10€

BRAKING

		BRAKING		BRAKING		BRAKING		BRAKING				
		Années	DISQUE AV WAVE	€ T.T.C.	DISQUE AR WAVE	€ T.T.C.	DISQUE AV ROND	€ T.T.C.	DISQUE AR ROND	€ T.T.C.	DISQUE 270mm OVERSIZE	€ T.T.C.
KTM												
380	XC380	98-99	KT02FID	142,30€	KT11RID WF450S	113,80€ 113,80€						
400	EGS400 LC4	93-98										
400	EGS400 LC4 LSE	97-98										
400	EGS400 LC4-E	99-99										
400	EGS400 LC4-E 4T	01-01										
400	EXC400	00-03	KT02FID	142,30€	KT11RID WF450S	113,80€ 113,80€					WL4007 POW68	195,10€ 60,10€
400	EXC400	04-09	KT02FID	142,30€	KT11RID WF450S	113,80€ 113,80€					WL4007 POW68	195,10€ 60,10€
400	EXC400	10-14	KT02FID	142,30€	KT11RID WF450S	113,80€ 113,80€					WL4007 PW4008	195,10€ 65,80€
400	MXC400	00-02	KT02FID	142,30€	KT11RID WF450S	113,80€ 113,80€						
400	SC400	99-00	KT02FID	142,30€	KT11RID WF450S	113,80€ 113,80€						
400	SX400 Enduro	00-02	KT02FID	142,30€	KT11RID WF450S	113,80€ 113,80€					WL4007 POW68	195,10€ 60,10€
400	SX400 Racing	00-00	KT02FID	142,30€	KT11RID WF450S	113,80€ 113,80€					WL4007 POW68	195,10€ 60,10€
400	SXC400 Tiainen Replica	99-00	KT02FID	142,30€	KT11RID WF450S	113,80€ 113,80€						
440	EXC440	94-95										
440	SX440	94-95										
450	EXC450-F	03-09	KT02FID	142,30€	KT11RID WF450S	113,80€ 113,80€					WL4007 POW68	195,10€ 60,10€
450	EXC450-F	10-22	KT02FID	142,30€	KT11RID WF450S	113,80€ 113,80€					WL4007 PW4008	195,10€ 65,80€
450	EXC450-R	02-09	KT02FID	142,30€	KT11RID WF450S	113,80€ 113,80€					WL4007 POW68	195,10€ 60,10€
450	EXC450-R	10-16	KT02FID	142,30€	KT11RID WF450S	113,80€ 113,80€					WL4007 PW4008	195,10€ 65,80€
450	MXC450	03-06	KT02FID	142,30€	KT11RID WF450S	113,80€ 113,80€						
450	RFR Rallye Factory Replica	11-14										
450	SC450 F	08-13										
450	SMR450	04-06	WK054L WK079L	297,70€ 282,10€	KT11RID WF450S	113,80€ 113,80€						
450	SMR450	07-12	WK054L WK079L	297,70€ 282,10€	KT11RID WF450S	113,80€ 113,80€						
450	SMR450	13-21	WK054L WK079L	297,70€ 282,10€	KT11RID WF450S	113,80€ 113,80€						
450	SX450 ATV	08-13										
450	SX450 Racing	03-06	KT02FID	142,30€	KT11RID WF450S	113,80€ 113,80€					WL4007 POW68	195,10€ 60,10€
450	SX450 Racing	15-15	KT02FID	142,30€	KT11RID WF450S	113,80€ 113,80€					WL4007 PW4008	195,10€ 65,80€
450	SX450-F	03-08	KT02FID	142,30€	KT11RID WF450S	113,80€ 113,80€					WL4007 POW68	195,10€ 60,10€
450	SX450-F	09-22	KT02FID	142,30€	KT11RID WF450S	113,80€ 113,80€					WL4007 PW4008	195,10€ 65,80€
450	SXS450-F	07-07	KT02FID	142,30€	KT11RID WF450S	113,80€ 113,80€						
450	SXS450-F	08-08	KT02FID	142,30€	KT11RID WF450S	113,80€ 113,80€					WL4007 PW4008	195,10€ 65,80€
450	XC450 ATV	08-13			KT11RID WF450S	113,80€ 113,80€						
450	XC450-F	07-07			KT11RID WF450S	113,80€ 113,80€						
450	XC450-F	08-13	KT02FID	142,30€	KT11RID WF450S	113,80€ 113,80€					WL4007 PW4008	195,10€ 65,80€
450	XC450-W /WR	08-13	KT02FID	142,30€	KT11RID WF450S	113,80€ 113,80€						
500	EXC500-F	12-22	KT02FID	142,30€	KT11RID WF450S	113,80€ 113,80€					WL4007 PW4008	195,10€ 65,80€
500	GS500 2T	82-84										
500	GS500 4T	82-84										
500	GS500 K4 Enduro 4T	82-84										
500	MX500	88-88			KT11RID WF450S	113,80€ 113,80€						
500	MX500	89-91			KT11RID WF450S	113,80€ 113,80€						
500	MX500	92-93	KT02FID	142,30€	KT11RID WF450S	113,80€ 113,80€						

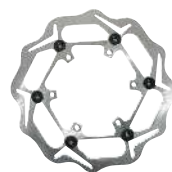

Cyl.	Modèle	Années	sbs		sbs		sbs		sbs	
			PLAQUETTES AV	€ T.T.C.	PLAQUETTES AR	€ T.T.C.	DISQUE AV	€ T.T.C.	DISQUE AR	€ T.T.C.
KTM										
500	SX500	92-95	671SI	28,40€	675SI	28,40€	5066	96,20€	5049	84,10€
505	SX505	09-13	671RSI	39,80€	791RSI	39,80€	5066	96,20€	5049	84,10€
505	SX505 ATV	08-13	866ATS	28,40€	867ATS	28,40€				
505	SX505 F Racing	07-08	671SI	28,40€	791SI	28,40€	5066	96,20€	5049	84,10€
505	SX505 F Racing	09-11	671SI	28,40€	791SI	28,40€	5066	96,20€	5049	84,10€
505	SX505 F Racing (US)	07-08	671SI	28,40€	791SI	28,40€	5066	96,20€	5049	84,10€
505	SX505 F Racing (US)	09-11	671SI	28,40€	791SI	28,40€	5066	96,20€	5049	84,10€
505	XC505 ATV	08-08	866ATS	28,40€	867ATS	28,40€				
505	XC505 ATV	09-13	866ATS	28,40€	867ATS	28,40€			5049	84,10€
505	XC505-F	09-13	671SI	28,40€	791SI	28,40€	5066	96,20€	5049	84,10€
520	EXC520 Racing	99-99	671SI	28,40€	675SI	28,40€	5066	96,20€	5049	84,10€
520	EXC520 Racing 4T	01-02	671SI	28,40€	675SI	28,40€	5066	96,20€	5049	84,10€
520	MXC520	99-99	671SI	28,40€	675SI	28,40€				
520	MXC520 2T	00-02	671SI	28,40€	675SI	28,40€				
520	MXC520 4T	01-02	671SI	28,40€	675SI	28,40€				
520	SX520 Racing	99-99	671SI	28,40€	675SI	28,40€	5066	96,20€	5049	84,10€
520	SX520 Racing 4T	01-02	671SI	28,40€	675SI	28,40€	5066	96,20€	5049	84,10€
525	EXC525 Racing 4T	03-03	671SI	28,40€	675SI	28,40€	5066	96,20€	5049	84,10€
525	EXC525 Racing 4T	04-07	671SI	28,40€	791SI	28,40€	5066	96,20€	5049	84,10€
525	MXC525 2T	03-03	671SI	28,40€	675SI	28,40€	5066	96,20€	5049	84,10€
525	MXC525 4T	03-03	671SI	28,40€	675SI	28,40€	5066	96,20€	5049	84,10€
525	MXC525 4T	04-05	671SI	28,40€	791SI	28,40€	5066	96,20€	5049	84,10€
525	MXC525 4T	06-06	671RSI	39,80€	791SI	28,40€	5066	96,20€	5049	84,10€
525	SX525 Racing 4T	03-03	671SI	28,40€	675SI	28,40€	5066	96,20€	5049	84,10€
525	SX525 Racing 4T	04-08	671SI	28,40€	791SI	28,40€	5066	96,20€	5049	84,10€
530	EXC530	08-09	671SI	28,40€	791SI	28,40€	5066	96,20€	5049	84,10€
530	EXC530	10-11	671SI	28,40€	791SI	28,40€	5066	96,20€	5049	84,10€
530	SX530 Racing	08-08	671RSI	39,80€	791RSI	39,80€	5066	96,20€	5049	84,10€
540	GS 540	98-00	671RSI	39,80€	675RSI	39,90€	5066	96,20€	5049	84,10€
540	SXC540 Tiainen Replica	98-00	671SI	28,40€	675SI	28,40€	5066	96,20€	5049	84,10€
550	MXC550	93-96	671SI	28,40€	675SI	28,40€				
560	SMR560	06-07	843RSI	39,90€	675RSI	39,90€			5049	84,10€
600	DUKE 600	93-93	566HF	30,90€	586HF	33,50€				
600	EGS600 LC4 Enduro	88-91	601HF	30,90€	601HF	30,90€	5066	96,20€	5049	84,10€
600	EGS600 LC4 Enduro	92-93	671SI	28,40€	586SI	28,40€	5066	96,20€	5049	84,10€
600	EXC600 LC4	88-92	621HF	30,90€	621HF	30,90€				
600	LC4 MX	88-89	601HF	30,90€	601HF	30,90€				
600	LC4 MX	90-91	546SI	28,40€	692SI	28,40€			5049	84,10€
600	LC4 MX	92-94	671SI	28,40€	586SI	28,40€				
600	LC4 MX	95-99	671RSI	39,80€	675SI	28,40€	5066	96,20€	5049	84,10€
620	EXC620 LC4	94-99	671SI	28,40€	675SI	28,40€	5066	96,20€	5049	84,10€
620	SC620	96-97	671SI	28,40€	675SI	28,40€	5066	96,20€	5049	84,10€

BRAKING

		BRAKING			BRAKING		BRAKING		BRAKING			
		Années	DISQUE AV WAVE	€ T.T.C.	DISQUE AR WAVE	€ T.T.C.	DISQUE AV ROND	€ T.T.C.	DISQUE AR ROND	€ T.T.C.	DISQUE 270mm OVERSIZE	€ T.T.C.
KTM												
500	SX500	92-95	KT02FID	142,30€	KT11RID WF4505	113,80€ 113,80€						
505	SX505	09-13	KT02FID	142,30€	KT11RID WF4505	113,80€ 113,80€					WL4007 PW4008	195,10€ 65,80€
505	SX505 ATV	08-13										
505	SX505 F Racing	07-08	KT02FID	142,30€	KT11RID WF4505	113,80€ 113,80€					WL4007 POW68	195,10€ 60,10€
505	SX505 F Racing	09-11	KT02FID	142,30€	KT11RID WF4505	113,80€ 113,80€					WL4007 PW4008	195,10€ 65,80€
505	SX505 F Racing (US)	07-08	KT02FID	142,30€	KT11RID WF4505	113,80€ 113,80€					WL4007 POW68	195,10€ 60,10€
505	SX505 F Racing (US)	09-11	KT02FID	142,30€	KT11RID WF4505	113,80€ 113,80€					WL4007 PW4008	195,10€ 65,80€
505	XC505 ATV	08-08										
505	XC505 ATV	09-13			KT11RID WF4505	113,80€ 113,80€						
505	XC505-F	09-13	KT02FID	142,30€	KT11RID WF4505	113,80€ 113,80€					WL4007 PW4008	195,10€ 65,80€
520	EXC520 Racing	99-99	KT02FID	142,30€	KT11RID WF4505	113,80€ 113,80€					WL4007 POW68	195,10€ 60,10€
520	EXC520 Racing 4T	01-02	KT02FID	142,30€	KT11RID WF4505	113,80€ 113,80€					WL4007 POW68	195,10€ 60,10€
520	MXC520	99-99										
520	MXC520 2T	00-02										
520	MXC520 4T	01-02										
520	SX520 Racing	99-99	KT02FID	142,30€	KT11RID WF4505	113,80€ 113,80€					WL4007 POW68	195,10€ 60,10€
520	SX520 Racing 4T	01-02	KT02FID	142,30€	KT11RID WF4505	113,80€ 113,80€					WL4007 POW68	195,10€ 60,10€
525	EXC525 Racing 4T	03-03	KT02FID	142,30€	KT11RID WF4505	113,80€ 113,80€					WL4007 POW68	195,10€ 60,10€
525	EXC525 Racing 4T	04-07	KT02FID	142,30€	KT11RID WF4505	113,80€ 113,80€					WL4007 POW68	195,10€ 60,10€
525	MXC525 2T	03-03	KT02FID	142,30€	KT11RID WF4505	113,80€ 113,80€						
525	MXC525 4T	03-03	KT02FID	142,30€	KT11RID WF4505	113,80€ 113,80€						
525	MXC525 4T	04-05	KT02FID	142,30€	KT11RID WF4505	113,80€ 113,80€						
525	MXC525 4T	06-06	KT02FID	142,30€	KT11RID WF4505	113,80€ 113,80€						
525	SX525 Racing 4T	03-03	KT02FID	142,30€	KT11RID WF4505	113,80€ 113,80€					WL4007 POW68	195,10€ 60,10€
525	SX525 Racing 4T	04-08	KT02FID	142,30€	KT11RID WF4505	113,80€ 113,80€					WL4007 POW68	195,10€ 60,10€
530	EXC530	08-09	KT02FID	142,30€	KT11RID WF4505	113,80€ 113,80€					WL4007 POW68	195,10€ 60,10€
530	EXC530	10-11	KT02FID	142,30€	KT11RID WF4505	113,80€ 113,80€					WL4007 PW4008	195,10€ 65,80€
530	SX530 Racing	08-08	KT02FID	142,30€	KT11RID WF4505	113,80€ 113,80€					WL4007 PW4008	195,10€ 65,80€
540	GS 540	98-00	KT02FID	142,30€	KT11RID WF4505	113,80€ 113,80€						
540	SXC540 Tiainen Replica	98-00	KT02FID	142,30€	KT11RID WF4505	113,80€ 113,80€						
550	MXC550	93-96										
560	SMR560	06-07	WK079L	282,10€	KT11RID WF4505	113,80€ 113,80€						
600	DUKE 600	93-93										
600	EGS600 LC4 Enduro	88-91	KT02FID	142,30€	KT11RID WF4505	113,80€ 113,80€						
600	EGS600 LC4 Enduro	92-93	KT02FID	142,30€	KT11RID WF4505	113,80€ 113,80€						
600	EXC600 LC4	88-92										
600	LC4 MX	88-89										
600	LC4 MX	90-91			KT11RID WF4505	113,80€ 113,80€						
600	LC4 MX	92-94										
600	LC4 MX	95-99	KT02FID	142,30€	KT11RID WF4505	113,80€ 113,80€						
620	EXC620 LC4	94-99	KT02FID	142,30€	KT11RID WF4505	113,80€ 113,80€						
620	SC620	96-97	KT02FID	142,30€	KT11RID WF4505	113,80€ 113,80€						

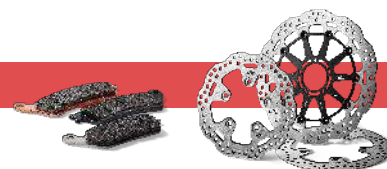

Cyl.	Modèle	Années	sbs		sbs		sbs		sbs	
			PLAQUETTES AV	€ T.T.C.	PLAQUETTES AR	€ T.T.C.	DISQUE AV	€ T.T.C.	DISQUE AR	€ T.T.C.
KTM										
620	SC620	98-99	671RSI	39,80€	675SI	28,40€	5066	96,20€	5049	84,10€
620	SC620	00-02	671SI	28,40€	675SI	28,40€	5066	96,20€	5049	84,10€
620	SX620 LC4	94-99	671SI	28,40€	675SI	28,40€	5066	96,20€	5049	84,10€
620	SXC620 LC4	00-02	671SI	28,40€	675SI	28,40€				
690	Enduro 690	08-15	674HS	44,40€	675LS	48,90€				
690	Enduro 690 R	09-13	674HS	44,40€	675LS	48,90€	5013	140,10€		
690	Enduro 690 R	14-21	674HS	44,40€	675LS	48,90€				
KYMCO										
50	FOX 50	00-00	02043	28,20€						
50	Maxxer 50	07-18	02012	21,30€	749ATS	26,40€				
50	Maxxer 50 S	19-20	02012	21,30€	749ATS	26,40€				
50	MXer 50	03-06	02012	21,30€	154HF	17,80€				
50	MXU50	05-15	02012	21,30€	749ATS	26,40€				
90	Maxxer 90	15-15	119HF	17,80€						
100	FOX 100	15-15	121HF 02043	15,60€ 28,20€	02189	40,30€				
150	Mxer 150	03-04	02012	21,30€	154CT	24,70€				
150	Mxer 150	05-06	02012	21,30€	749ATS	26,40€				
150	MXU150	07-19	02012	21,30€	749ATS	26,40€				
250	KXR250 Sport	04-14	810ATS	28,40€	775ATS	28,40€				
250	Maxxer 250	08-17	810ATS	28,40€	775ATS	28,40€				
250	MXU250	05-10	810ATS	28,40€	775ATS	28,40€				
300	Maxxer 300	06-21	810ATS	28,40€	775ATS	28,40€				
300	MXU300	06-21	810ATS	28,40€	810ATS	28,40€				
400	MXU400	12-17	822ATS	28,40€	822ATS	28,40€				
450	Maxxer 450 I	12-19	822ATS	28,40€	822ATS	28,40€				
500	MXU500	06-08	810ATS	28,40€	810ATS	28,40€				
500	MXU500	09-17	945ATS	28,40€						
500	UXV i 500	12-15	810ATS	28,40€	810ATS	28,40€				
550	MXU550 I	14-21	945ATS	28,40€	810ATS	28,40€				
700	MXU700 I	18-21	945ATS	28,40€	810ATS	28,40€				
700	UXV i 700	14-21	945ATS	28,40€						
700	UXV i 700 Sport	15-15	945ATS	28,40€						
MONTESA										
125	Cota 304 125	86-99	559SI	28,40€	559SI	28,40€				
250	Cota 315R 250	97-00	559SI	28,40€	559SI	28,40€				
250	Cota 4RT 250	05-13			803RSI	39,80€				
260	Cota 304 260	86-89	559SI	28,40€	559SI	28,40€				
260	Cota 307 260	87-90	559SI	28,40€	559SI	28,40€				
260	Cota 309 260	89-90	559SI	28,40€	519SI	28,40€				
260	Cota 310 260	90-92	559SI	28,40€	519SI	28,40€				
260	Cota 311 260	92-96	559SI	28,40€	519SI	28,40€				
260	Cota 330 260	85-87	559SI	28,40€	559SI	28,40€				
260	Cota 335 260	87-89	559SI	28,40€	559SI	28,40€				
260	Cota 4 Ride	16-16	939RSI	39,80€	803RSI	39,80€				
260	Cota 4RT 260	14-19			803RSI	39,80€				
260	Cota 4RT 260 Race Replica	15-16	939RSI	39,80€	803RSI	39,80€				
260	Evasion 260	91-91	559SI	28,40€	519SI	28,40€				
300	Cota 300 RR	16-19	939RSI	39,80€	803RSI	39,80€				
360	Cota 314R 360	97-00	559SI	28,40€	559SI	28,40€				
360	Cota 315R 360	01-04	559SI	28,40€	559SI	28,40€				
360	Enduro 360	85-85	559SI	28,40€						
360	Enduro 360	86-86	595HF	21,24€						
MUZ										
125	SM125	99-01	681HF	30,90€	633HF	33,50€				
125	SM125	02-11	713HF	31,44€	633HF	33,50€				
125	SX125	99-01	681HF	30,90€	633SI	28,40€				
125	SX125	02-11	713HF	31,44€	633SI	28,40€				

BRAKING

		BRAKING		BRAKING		BRAKING		BRAKING				
		Années	DISQUE AV WAVE	€ T.T.C.	DISQUE AR WAVE	€ T.T.C.	DISQUE AV ROND	€ T.T.C.	DISQUE AR ROND	€ T.T.C.	DISQUE 270mm OVERSIZE	€ T.T.C.
KTM												
620	SC620	98-99	KT02FID	142,30€	KT11RID WF4505	113,80€ 113,80€						
620	SC620	00-02	KT02FID	142,30€	KT11RID WF4505	113,80€ 113,80€						
620	SX620 LC4	94-99	KT02FID	142,30€	KT11RID WF4505	113,80€ 113,80€						
620	SXC620 LC4	00-02										
690	Enduro 690	08-15			KT10RID	142,20€						
690	Enduro 690 R	09-13			KT10RID	142,20€						
690	Enduro 690 R	14-21			KT10RID	142,20€						
KYMCO												
50	FOX 50	00-00										
50	Maxxer 50	07-18										
50	Maxxer 50 S	19-20										
50	MXer 50	03-06					KM01FI	51,20€				
50	MXU50	05-15										
90	Maxxer 90	15-15										
100	FOX 100	15-15										
150	Mxer 150	03-04										
150	Mxer 150	05-06										
150	MXU150	07-19										
250	KXR250 Sport	04-14										
250	Maxxer 250	08-17										
250	MXU250	05-10										
300	Maxxer 300	06-21										
300	MXU300	06-21										
400	MXU400	12-17										
450	Maxxer 450 I	12-19										
500	MXU500	06-08										
500	MXU500	09-17										
500	UXV i 500	12-15										
550	MXU550 I	14-21										
700	MXU700 I	18-21										
700	UXV i 700	14-21										
700	UXV i 700 Sport	15-15										
MONTESA												
125	Cota 304 125	86-99										
250	Cota 315R 250	97-00										
250	Cota 4RT 250	05-13										
260	Cota 304 260	86-89										
260	Cota 307 260	87-90										
260	Cota 309 260	89-90										
260	Cota 310 260	90-92										
260	Cota 311 260	92-96										
260	Cota 330 260	85-87										
260	Cota 335 260	87-89										
260	Cota 4 Ride	16-16										
260	Cota 4RT 260	14-19										
260	Cota 4RT 260 Race Replica	15-16										
260	Evasion 260	91-91										
300	Cota 300 RR	16-19										
360	Cota 314R 360	97-00										
360	Cota 315R 360	01-04										
360	Enduro 360	85-85										
360	Enduro 360	86-86										
MUZ												
125	SM125	99-01										
125	SM125	02-11										
125	SX125	99-01										
125	SX125	02-11										



Cyl.	Modèle	Années	sbs		sbs		sbs		sbs	
			PLAQUETTES AV	€ T.T.C.	PLAQUETTES AR	€ T.T.C.	DISQUE AV	€ T.T.C.	DISQUE AR	€ T.T.C.
MUZ										
125	VRT125	05-06			638ATS	28,40€				
150	VRS150	05-06			544ATS	28,40€				
175	VRT175	05-06			638ATS	28,40€				
PGO										
50	Bugrider 50	06-09	855HF	33,50€	536HF	22,60€				
125	X-Rider 125	03-10			544ATS	28,40€				
150	X-Rider 150	03-05			544ATS	28,40€				
200	BR200 Bugrider	07-11	855HF	33,50€	848HF	33,50€				
250	BR250 Bugrider	05-11	855HF	33,50€	848HF	33,50€				
POLARIS										
50	Outlaw 50	08-09	02048	28,20€						
50	Predator 50	04-05	02048	28,20€						
50	Scrambler 50	01-03	02048	28,20€						
90	Outlaw 90	08-09	02048	28,20€						
90	Predator 90	03-05	02048	28,20€						
90	Scrambler 90	01-03	02048	28,20€						
90	Sportsman 90	01-11	02048	28,20€						
200	Phoenix 200	05-09	716ATS	28,40€	544ATS	28,40€				
200	Phoenix 200	10-14	905ATS	28,40€	544ATS	28,40€				
200	Sawtooth	06-07	544ATS	28,40€	544ATS	28,40€				
250	2x4 250	90-93	716ATS	28,40€	717ATS	28,40€				
250	4x4 250	90-93	716ATS	28,40€	717ATS	28,40€				
250	Big Boss 4x6 250	89-93	716ATS	28,40€	717ATS	28,40€				
250	Big Boss 6x6 250	89-93	716ATS	28,40€	717ATS	28,40€				
250	Trail Blazer 250	94-98	716ATS	28,40€	717ATS	28,40€				
250	Trail Blazer 250	02-05	716ATS	28,40€	755ATS	28,40€				
250	Trail Blazer 250	99-01	716ATS	28,40€	755ATS	28,40€				
250	Trail Boss 250	85-90	642ATS	28,40€	643HF	30,90€				
250	Trail Boss 250	91-99	716ATS	28,40€	643HF	30,90€				
250	Trail Boss 2x4 250	91-93	716ATS	28,40€	717ATS	28,40€				
250	Trail Boss 4x4 250	91-92	716ATS	28,40€	717ATS	28,40€				
250	Xplorer 4x4 250	00-02	716ATS	28,40€	755ATS	28,40€				
300	2x4 300	94-95	716ATS	28,40€	717ATS	28,40€				
300	4x4 300	94-95	716ATS	28,40€	717ATS	28,40€				
300	Big Boss 6x6 300	94-95	716ATS	28,40€	717ATS	28,40€				
300	Hawkeye 2x4 300	06-06	822ATS	28,40€	716ATS	28,40€				
300	Hawkeye 2x4 300	07-13	716ATS	28,40€	716ATS	28,40€				
300	Hawkeye 4x4 300	06-06	822ATS	28,40€	716ATS	28,40€				
300	Hawkeye 4x4 300	07-13	716ATS	28,40€	716ATS	28,40€				
300	Sportsman 300	08-13	716ATS	28,40€	716ATS	28,40€				
300	Xplorer 2x4 300	98-99	716ATS	28,40€	717ATS	28,40€				
300	Xplorer 4x4 300	96-99	716ATS	28,40€	717ATS	28,40€				
300	Xpress 300 L	96-99	716ATS	28,40€	717ATS	28,40€				
325	Magnum 2x4 325	00-02	716ATS	28,40€	755ATS	28,40€				
325	Magnum 4x4 325	00-02	716ATS	28,40€	755ATS	28,40€				
325	Trail Boss 325	00-02	716ATS	28,40€	755ATS	28,40€				
325	Xpedition 325	00-01	642ATS	28,40€	755ATS	28,40€				
325	Xpedition 325	02-02	642ATS	28,40€	787ATS	28,40€				
330	ATP330	04-05	716ATS	28,40€	716ATS	28,40€				
330	ATP330	06-07	716ATS	28,40€	787ATS	28,40€				
330	Hawkeye 2x4 330	06-06	716ATS	28,40€	787ATS	28,40€				
330	Hawkeye 4x4 330	06-06	716ATS	28,40€	787ATS	28,40€				
330	Magnum 2x4 330	03-06	716ATS	28,40€	787ATS	28,40€				
330	Magnum 4x4 330	03-06	716ATS	28,40€	787ATS	28,40€				
330	Trail Blazer 2x4 330	08-13	642ATS	28,40€	787ATS	28,40€				
330	Trail Boss 2x4 330	03-13	716ATS	28,40€	755ATS	28,40€				
335	Sportsman 4x4 335	99-01	716ATS	28,40€	755ATS	28,40€				
350	Big Boss 6x6 350	93-95	716ATS	28,40€	717ATS	28,40€				
350	Sportsman 4x4 350	93-95	716ATS	28,40€	717ATS	28,40€				



		BRAKING		BRAKING		BRAKING		BRAKING		BRAKING		
		Années	DISQUE AV WAVE	€ T.T.C.	DISQUE AR WAVE	€ T.T.C.	DISQUE AV ROND	€ T.T.C.	DISQUE AR ROND	€ T.T.C.	DISQUE 270mm OVERSIZE	€ T.T.C.
MUZ												
125	VRT125	05-06										
150	VRS150	05-06										
175	VRT175	05-06										
PGO												
50	Bugrider 50	06-09										
125	X-Rider 125	03-10										
150	X-Rider 150	03-05										
200	BR200 Bugrider	07-11										
250	BR250 Bugrider	05-11										
POLARIS												
50	Outlaw 50	08-09										
50	Predator 50	04-05										
50	Scrambler 50	01-03										
90	Outlaw 90	08-09										
90	Predator 90	03-05										
90	Scrambler 90	01-03										
90	Sportsman 90	01-11										
200	Phoenix 200	05-09										
200	Phoenix 200	10-14										
200	Sawtooth	06-07										
250	2x4 250	90-93										
250	4x4 250	90-93										
250	Big Boss 4x6 250	89-93										
250	Big Boss 6x6 250	89-93										
250	Trail Blazer 250	94-98										
250	Trail Blazer 250	02-05										
250	Trail Blazer 250	99-01										
250	Trail Boss 250	85-90										
250	Trail Boss 250	91-99										
250	Trail Boss 2x4 250	91-93										
250	Trail Boss 4x4 250	91-92										
250	Xplorer 4x4 250	00-02										
300	2x4 300	94-95										
300	4x4 300	94-95										
300	Big Boss 6x6 300	94-95										
300	Hawkeye 2x4 300	06-06										
300	Hawkeye 2x4 300	07-13										
300	Hawkeye 4x4 300	06-06										
300	Hawkeye 4x4 300	07-13										
300	Sportsman 300	08-13										
300	Xplorer 2x4 300	98-99										
300	Xplorer 4x4 300	96-99										
300	Xpress 300 L	96-99										
325	Magnum 2x4 325	00-02										
325	Magnum 4x4 325	00-02										
325	Trail Boss 325	00-02										
325	Xpedition 325	00-01										
325	Xpedition 325	02-02										
330	ATP330	04-05										
330	ATP330	06-07										
330	Hawkeye 2x4 330	06-06										
330	Hawkeye 4x4 330	06-06										
330	Magnum 2x4 330	03-06										
330	Magnum 4x4 330	03-06										
330	Trail Blazer 2x4 330	08-13										
330	Trail Boss 2x4 330	03-13										
335	Sportsman 4x4 335	99-01										
350	Big Boss 6x6 350	93-95										
350	Sportsman 4x4 350	93-95										



Cyl.	Modèle	Années	sbs		sbs		sbs		sbs	
			PLAQUETTES AV	€ T.T.C.	PLAQUETTES AR	€ T.T.C.	DISQUE AV	€ T.T.C.	DISQUE AR	€ T.T.C.
POLARIS										
350	Trail Boss 2x4 350 L	90-93	716ATS	28,40€	717ATS	28,40€				
350	Trail Boss 4x4 350 L	90-93	716ATS	28,40€	717ATS	28,40€				
400	Big Boss 6x6 400 L	96-97	716ATS	28,40€	717ATS	28,40€				
400	Scrambler 2x4 400	00-02	716ATS	28,40€	755ATS	28,40€				
400	Scrambler 4x4 400	98-98	716ATS	28,40€	717ATS	28,40€				
400	Scrambler 4x4 400	99-99	716ATS	28,40€	755ATS	28,40€				
400	Scrambler 4x4 400	00-02	716ATS	28,40€	577HF	30,90€				
400	Scrambler 4x4 400 L	95-97	716ATS	28,40€	577HF	30,90€				
400	Sport 400 L	94-94	716ATS	28,40€	577HF	30,90€				
400	Sport 400 L	95-99	716ATS	28,40€	717ATS	28,40€				
400	Sport 400 L	00-00	716ATS	28,40€	755ATS	28,40€				
400	Sportsman 400	01-05	716ATS	28,40€	755ATS	28,40€				
400	Sportsman 400 HO	08-13	716ATS	28,40€	716ATS	28,40€				
400	Trail Blazer 2x4 400	03-03	716ATS	28,40€	755ATS	28,40€				
400	Xplorer 4x4 400 L	95-99	716ATS	28,40€	717ATS	28,40€				
400	Xplorer 4x4 400 L	00-01	716ATS	28,40€	755ATS	28,40€				
400	Xpress 400 L	96-97	716ATS	28,40€	717ATS	28,40€				
425	Magnum 2x4 425	95-98	716ATS	28,40€	717ATS	28,40€				
425	Magnum 4x4 425	95-98	716ATS	28,40€	717ATS	28,40€				
425	Magnum 6x6 425	96-97	716ATS	28,40€	755ATS	28,40€				
425	Ranger 425	01-03	716ATS	28,40€	755ATS	28,40€				
425	Xpedition 4x4 425	00-02	716ATS	28,40€	755ATS	28,40€				
450	Outlaw 450 MXR /S	08-11	642ATS	28,40€	642ATS	28,40€				
450	Sportsman 450	06-07	716ATS	28,40€	787ATS	28,40€				
500	ATP500 HO	04-05	716ATS	28,40€	716ATS	28,40€				
500	Big Boss 6x6 500	98-99	716ATS	28,40€	717ATS	28,40€				
500	Magnum 2x4 500	02-02	716ATS	28,40€	787ATS	28,40€				
500	Magnum 4x4 500	00-01	716ATS	28,40€	755ATS	28,40€				
500	Magnum 4x4 500	02-02	716ATS	28,40€	787ATS	28,40€				
500	Outlaw 500	06-07	716ATS	28,40€	716ATS	28,40€				
500	Predator 500	03-04	716ATS	28,40€	717ATS	28,40€				
500	Predator 500	05-05	716ATS	28,40€	716ATS	28,40€				
500	Predator 500	06-07	716ATS	28,40€	787ATS	28,40€				
500	Scrambler 2x4 500	00-07	716ATS	28,40€	755ATS	28,40€				
500	Scrambler 2x4 500 E	08-11	642ATS	28,40€	787ATS	28,40€				
500	Scrambler 4x4 500	96-97	716ATS	28,40€	717ATS	28,40€				
500	Scrambler 4x4 500	98-04	716ATS	28,40€	755ATS	28,40€				
500	Scrambler 4x4 500	05-07	716ATS	28,40€	787ATS	28,40€				
500	Scrambler 4x4 500 E	08-12	642ATS	28,40€	787ATS	28,40€				
500	Sportsman 500 EFI	06-10	716ATS	28,40€	716ATS	28,40€				
500	Sportsman 500 HO	03-14	642ATS	28,40€	787ATS	28,40€				
500	Sportsman 6x6 500	00-11	716ATS	28,40€	757ATS	27,48€				
500	Sportsman Touring 500 EFI	08-14	716ATS	28,40€	716ATS	28,40€				
500	Sportsman X2 500	06-07	716ATS	28,40€	787ATS	28,40€				
500	Sportsman X2 500 EFI	08-14	716ATS	28,40€	787ATS	28,40€				
500	Xplorer 4x4 500	97-97	716ATS	28,40€	717ATS	28,40€				
525	Outlaw 525 /s	07-11	716ATS	28,40€	716ATS	28,40€				
550	Sportsman XP 550 EFI	09-14	899ATS	28,40€	899ATS	28,40€				
570	Sportsman 570 EFI	15-18	899ATS	28,40€	899ATS	28,40€				
600	Sportsman 600	03-06	642ATS	28,40€	787ATS	28,40€				
700	Ranger 6x6 EFI 700	07-13	800ATS	28,40€	800ATS	28,40€				
700	Ranger 700 Crew	09-13	800ATS	28,40€	800ATS	28,40€				
700	Ranger 700 HD	09-13	800ATS	28,40€	800ATS	28,40€				
700	Ranger 700 XP	08-13	800ATS	28,40€	800ATS	28,40€				
700	Sportsman 700	02-06	642ATS	28,40€	787ATS	28,40€				
700	Sportsman 700 EFI	05-07	642ATS	28,40€	787ATS	28,40€				
700	Sportsman 700 MV	05-06	642ATS	28,40€	787ATS	28,40€				
700	Sportsman X2 700 EFI	08-08	642ATS	28,40€	787ATS	28,40€				
800	Ranger RZR 800	08-13	642ATS	28,40€						

BRAKING

		BRAKING		BRAKING		BRAKING		BRAKING				
		Années	DISQUE AV WAVE	€ T.T.C.	DISQUE AR WAVE	€ T.T.C.	DISQUE AV ROND	€ T.T.C.	DISQUE AR ROND	€ T.T.C.	DISQUE 270mm OVERSIZE	€ T.T.C.
POLARIS												
350	Trail Boss 2x4 350 L	90-93										
350	Trail Boss 4x4 350 L	90-93										
400	Big Boss 6x6 400 L	96-97										
400	Scrambler 2x4 400	00-02										
400	Scrambler 4x4 400	98-98										
400	Scrambler 4x4 400	99-99										
400	Scrambler 4x4 400	00-02										
400	Scrambler 4x4 400 L	95-97										
400	Sport 400 L	94-94										
400	Sport 400 L	95-99										
400	Sport 400 L	00-00										
400	Sportsman 400	01-05										
400	Sportsman 400 HO	08-13										
400	Trail Blazer 2x4 400	03-03										
400	Xplorer 4x4 400 L	95-99										
400	Xplorer 4x4 400 L	00-01										
400	Xpress 400 L	96-97										
425	Magnum 2x4 425	95-98										
425	Magnum 4x4 425	95-98										
425	Magnum 6x6 425	96-97										
425	Ranger 425	01-03										
425	Xpedition 4x4 425	00-02										
450	Outlaw 450 MXR /S	08-11										
450	Sportsman 450	06-07										
500	ATP500 HO	04-05										
500	Big Boss 6x6 500	98-99										
500	Magnum 2x4 500	02-02										
500	Magnum 4x4 500	00-01										
500	Magnum 4x4 500	02-02										
500	Outlaw 500	06-07										
500	Predator 500	03-04										
500	Predator 500	05-05										
500	Predator 500	06-07										
500	Scrambler 2x4 500	00-07										
500	Scrambler 2x4 500 E	08-11										
500	Scrambler 4x4 500	96-97										
500	Scrambler 4x4 500	98-04										
500	Scrambler 4x4 500	05-07										
500	Scrambler 4x4 500 E	08-12										
500	Sportsman 500 EFI	06-10										
500	Sportsman 500 HO	03-14										
500	Sportsman 6x6 500	00-11										
500	Sportsman Touring 500 EFI	08-14										
500	Sportsman X2 500	06-07										
500	Sportsman X2 500 EFI	08-14										
500	Xplorer 4x4 500	97-97										
525	Outlaw 525 /s	07-11										
550	Sportsman XP 550 EFI	09-14										
570	Sportsman 570 EFI	15-18										
600	Sportsman 600	03-06										
700	Ranger 6x6 EFI 700	07-13										
700	Ranger 700 Crew	09-13										
700	Ranger 700 HD	09-13										
700	Ranger 700 XP	08-13										
700	Sportsman 700	02-06										
700	Sportsman 700 EFI	05-07										
700	Sportsman 700 MV	05-06										
700	Sportsman X2 700 EFI	08-08										
800	Ranger RZR 800	08-13										

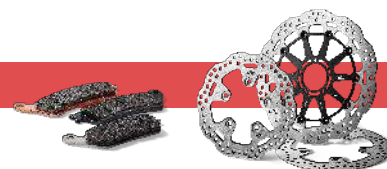

Cyl.	Modèle	Années	sbs		sbs		sbs		sbs	
			PLAQUETTES AV	€ T.T.C.	PLAQUETTES AR	€ T.T.C.	DISQUE AV	€ T.T.C.	DISQUE AR	€ T.T.C.
POLARIS										
800	Sportsman 800 EFI	05-13	642ATS	28,40€	787ATS	28,40€				
800	Sportsman Big Boss 6x6 800	09-13	642ATS	28,40€	787ATS	28,40€				
800	Sportsman HO 800 EFI	08-13	642ATS	28,40€	787ATS	28,40€				
800	Sportsman Touring 800 EFI	08-13	642ATS	28,40€	787ATS	28,40€				
800	Sportsman X2 800 EFI	07-13	642ATS	28,40€	787ATS	28,40€				
850	Sportsman XP 850 EFI	09-13	899ATS	28,40€	899ATS	28,40€				
1000	Scrambler XP 1000	16-17	899ATS	28,40€	899ATS	28,40€				
1000	Sportsman XP 1000	16-17	899ATS	28,40€	899ATS	28,40€				
RIEJU										
250	MR250	22-22	694SI	28,40€	790SI	28,40€			5133	73,10€
300	MR300	21-22	694SI	28,40€	790SI	28,40€			5133	73,10€
300	MR300 Ranger	22-22	671SI	28,40€	791SI	28,40€				
450	MRX450	08-11	671SI	28,40€	791SI	28,40€				
SYM/SANYANG										
200	Track Runner 200	05-09	810ATS	28,40€	201HF	17,80€				
250	QuadLander 250	05-05	810ATS	28,40€	810ATS	28,40€				
250	QuadLander 250	06-13	810ATS	28,40€						
300	City Max 300	06-08	810ATS	28,40€	201MS	28,60€				
300	City Max 300	09-13	810ATS	28,40€	201MS	28,60€				
300	Quadlander 300 S	06-13	810ATS	28,40€	810ATS	28,40€				
600	Quad Raider 600	08-13	810ATS	28,40€	810ATS	28,40€				
SHERCO										
50	Enduro 50	03-06	186HF	17,80€	105HF	12,90€				
50	Enduro 50	07-13	168HF	17,80€	167HF	17,80€				
50	SE 0.5 50	09-16	168HF	17,80€	167HF	17,80€				
50	Sherco 0.5 50	02-08			105HF	12,90€				
50	SM 0.5 50	09-13	168HF	17,80€	167HF	17,80€				
50	SM 0.5 50 Black Panther	09-13	168HF	17,80€	167HF	17,80€				
80	Sherco 0.8 80	03-08	559HF	22,60€	559HF	22,60€				
80	ST 0.8 80	09-13	559HF	22,60€	559HF	22,60€				
125	City Corp 125 Enduro	04-06	817HF	27,50€	559HF	22,60€				
125	City Corp 125 Supermotard	04-06	817HF	27,50€	559HF	22,60€				
125	SC125	19-19	671RSI	39,80€	791RSI	39,80€				
125	SE 125-F	09-11	774HF	22,60€						
125	SE 125-R	18-20	671SI	28,40€	791SI	28,40€				
125	SE 125-R	21-22	671SI	28,40€	791SI	28,40€				
125	Sherco 1.25 125	03-06	559HF	22,60€	559HF	22,60€				
125	SM 125-F	09-09	559HF	22,60€	559HF	22,60€				
125	ST 1.25 125	09-17	802RSI	39,80€	803RSI	39,80€				
125	ST 125	18-22	802RSI	39,80€	803RSI	39,80€				
125	X-Ride 125	11-19	544SI	28,40€	544SI	28,40€				
200	Sherco 2.0 200	03-06	559HF	22,60€	559HF	22,60€				
250	Enduro 2.5 i 250	05-11	671SI	28,40€	790SI	28,40€				
250	SC250	19-19	671RSI	39,80€	791RSI	39,80€				
250	SCF250	19-19	671RSI	39,80€	791RSI	39,80€				
250	SE 2.5i-F 250	09-13	671SI	28,40€	791SI	28,40€				
250	SE-R 250	14-20	671SI	28,40€	791SI	28,40€				
250	SE-R 250	21-22	671SI	28,40€	791SI	28,40€				
250	SE-R 250 Factory	14-22	671SI	28,40€	791SI	28,40€				
250	SEF-R 2,5 250 4T	14-20	671SI	28,40€	791SI	28,40€				
250	SEF-R 2,5 250 4T	21-22	671SI	28,40€	791SI	28,40€				
250	SEF-R 2,5 250 4T Factory	14-22	671SI	28,40€	791SI	28,40€				
250	Sherco 2.5 250	98-98	559RSI	39,80€	559RSI	39,80€				
250	Sherco 2.5 250	99-00	559HF	22,60€	559HF	22,60€				
250	Sherco 2.5 250	01-14	802RSI	39,80€	803RSI	39,80€				
250	ST 2.5 250	09-17	802RSI	39,80€	803RSI	39,80€				
250	ST 250	18-22	802RSI	39,80€	803RSI	39,80€				
250	SX 250 2,5i-F	09-11	671RSI	39,80€	790RSI	39,80€				

BRAKING

		BRAKING		BRAKING		BRAKING		BRAKING		
		Années	DISQUE AV WAVE	€ T.T.C.	DISQUE AR WAVE	€ T.T.C.	DISQUE AV ROND	€ T.T.C.	DISQUE AR ROND	€ T.T.C.
									DISQUE 270mm OVERSIZE	€ T.T.C.
POLARIS										
800	Sportsman 800 EFI	05-13								
800	Sportsman Big Boss 6x6 800	09-13								
800	Sportsman HO 800 EFI	08-13								
800	Sportsman Touring 800 EFI	08-13								
800	Sportsman X2 800 EFI	07-13								
850	Sportsman XP 850 EFI	09-13								
1000	Scrambler XP 1000	16-17								
1000	Sportsman XP 1000	16-17								
RIEJU										
250	MR250	22-22	GA04FLD	195,10€	KT11RID WF4505	113,80€ 113,80€				
300	MR300	21-22	GA04FLD	195,10€	KT11RID WF4505	113,80€ 113,80€				
300	MR300 Ranger	22-22								
450	MRX450	08-11								
SYM/SANYANG										
200	Track Runner 200	05-09								
250	QuadLander 250	05-05								
250	QuadLander 250	06-13								
300	City Max 300	06-08								
300	City Max 300	09-13								
300	Quadlander 300 S	06-13								
600	Quad Raider 600	08-13								
SHERCO										
50	Enduro 50	03-06								
50	Enduro 50	07-13								
50	SE 0.5 50	09-16								
50	Sherco 0.5 50	02-08								
50	SM 0.5 50	09-13								
50	SM 0.5 50 Black Panther	09-13								
80	Sherco 0.8 80	03-08								
80	ST 0.8 80	09-13								
125	City Corp 125 Enduro	04-06								
125	City Corp 125 Supermotard	04-06								
125	SC125	19-19								
125	SE 125-F	09-11								
125	SE 125-R	18-20			WF4511	119,50€				
125	SE 125-R	21-22								
125	Sherco 1.25 125	03-06								
125	SM 125-F	09-09								
125	ST 1.25 125	09-17								
125	ST 125	18-22								
125	X-Ride 125	11-19								
200	Sherco 2.0 200	03-06								
250	Enduro 2.5 i 250	05-11			SH01RID	132,80€				
250	SC250	19-19								
250	SCF250	19-19								
250	SE 2.5i-F 250	09-13								
250	SE-R 250	14-20			WF4511	119,50€				
250	SE-R 250	21-22								
250	SE-R 250 Factory	14-22								
250	SEF-R 2,5 250 4T	14-20			WF4511	119,50€				
250	SEF-R 2,5 250 4T	21-22								
250	SEF-R 2,5 250 4T Factory	14-22								
250	Sherco 2.5 250	98-98								
250	Sherco 2.5 250	99-00								
250	Sherco 2.5 250	01-14								
250	ST 2.5 250	09-17								
250	ST 250	18-22								
250	SX 250 2,5i-F	09-11			SH01RID	132,80€				

FREINAGE

Cyl.	Modèle	Années	sbs		sbs		sbs		sbs	
			PLAQUETTES AV	€ T.T.C.	PLAQUETTES AR	€ T.T.C.	DISQUE AV	€ T.T.C.	DISQUE AR	€ T.T.C.
SHERCO										
290	Sherco 2.9 290	01-15	802RSI	39,80€	803RSI	39,80€				
290	ST 2.9 290	09-13	802RSI	39,80€	803RSI	39,80€				
290	X-Ride 290	11-19	544SI	28,40€	544SI	28,40€				
300	SC300	19-19	671SI	28,40€	791SI	28,40€				
300	SCF300	19-19	671SI	28,40€	791SI	28,40€				
300	SE-R 3,0	13-16	671SI	28,40€	791SI	28,40€				
300	SE-R 3,0 i	10-12	671SI	28,40€	791SI	28,40€				
300	SE-R 300	15-20	671SI	28,40€	791SI	28,40€				
300	SE-R 300	21-22	671SI	28,40€	791SI	28,40€				
300	SE-R 300 Factory	13-22	671SI	28,40€	791SI	28,40€				
300	SEF-R 300 4T	14-20	671SI	28,40€	791SI	28,40€				
300	SEF-R 300 4T	21-22	671SI	28,40€	791SI	28,40€				
300	SEF-R 300 4T Factory	14-22	671SI	28,40€	791SI	28,40€				
300	ST 3,0 Factory	14-16	802RSI	39,80€	803RSI	39,80€				
300	ST 3.0 2T	13-17	802RSI	39,80€	803RSI	39,80€				
300	ST 3.0R 2T	13-14	802RSI	39,80€	803RSI	39,80€				
300	ST 300	18-22	802RSI	39,80€	803RSI	39,80€				
320	Sherco 3.2 320	03-08	802RSI	39,80€	803RSI	39,80€				
320	ST 3.2-F 320	09-13	802RSI	39,80€	803RSI	39,80€				
450	Enduro 4.5i 450	04-04	671SI	28,40€	604SI	28,40€				
450	Enduro 4.5i 450	05-08	671SI	28,40€	790SI	28,40€				
450	SCF450	19-19	671RSI	39,80€	790RSI	39,80€				
450	SE 4.5i-F 450	09-13	671SI	28,40€	790SI	28,40€				
450	SEF-R 450	17-20	671SI	28,40€	790SI	28,40€				
450	SEF-R 450	21-21	671SI	28,40€	790SI	28,40€				
450	SEF-R 450 Factory	16-21	671SI	28,40€	790SI	28,40€				
450	SM 4.5i-F 450	09-13	762081	74,50€	790RSI	39,80€				
450	Supermotard 4.5i 450	05-05	762081	74,50€	790SI	28,40€				
450	Supermotard 4.5i 450	06-08	762081	74,50€	790RSI	39,80€				
500	SCF500	19-19	671RSI	39,80€	790RSI	39,80€				
500	SEF-R 500	20-20	671SI	28,40€	790SI	28,40€				
500	SEF-R 500	21-21	671SI	28,40€	790SI	28,40€				
500	SEF-R 500 Factory	20-21	671SI	28,40€	790SI	28,40€				
510	Enduro 5.1i 510	06-08	671SI	28,40€	790SI	28,40€				
510	SE 5.1i-F 510	09-11	671SI	28,40€	790SI	28,40€				
510	SM 5.1i-F 510	09-13	671SI	28,40€	790SI	28,40€				
510	Supermotard 5.1i 510	07-08	762081	74,50€	790RSI	39,80€				
SUZUKI										
50	JR 50	04-07	02020	26,30€	02020	26,30€				
50	JR 80	01-01	02017	32,30€	02017	32,30€				
50	LT50	84-99			02020	26,30€				
50	LT50 A Quadmaster	02-15	02101	29,90€	02017	32,30€				
50	LT50 L	98-03			02020	26,30€				
50	LT50 Z Quadsport	15-20	02101	29,90€	02017	32,30€				
65	RM65	03-06	752SI	28,40€	536SI	28,40€				
70	DR-Z 70 L	12-18	02010	24,10€	02010	24,10€				
80	LT80 Quadsport	89-10	02101	29,90€	02104	40,30€				
80	RM80	80-81	02017	32,30€	02017	32,30€				
80	RM80	82-82			02182	26,30€				
80	RM80 H	83-85			02017	32,30€				
80	RM80	83-85	02014	28,20€	02182	26,30€				
80	RM80	86-88	548HF	33,50€	02182	26,30€				
80	RM80	89-89	548HF	33,50€	02182	26,30€				
80	RM80	90-95	544SI	28,40€	544SI	28,40€				
80	RM80	96-01	702SI	28,40€	544SI	28,40€				
85	RM85	02-04	702RSI	39,80€	544RSI	39,90€				
85	RM85	05-22	726RSI	39,90€	820RSI	39,80€	5255	73,10€	5284	-
90	LT-Z 90	07-13	02017	32,30€	02104	40,30€				
110	DRZ110	01-07	02093	26,30€	02015	28,50€				

		BRACING		BRACING		BRACING		BRACING		BRACING		
		Années	DISQUE AV WAVE	€ T.T.C.	DISQUE AR WAVE	€ T.T.C.	DISQUE AV ROND	€ T.T.C.	DISQUE AR ROND	€ T.T.C.	DISQUE 270mm OVERSIZE	€ T.T.C.
SHERCO												
290	Sherco 2.9 290	01-15										
290	ST 2.9 290	09-13										
290	X-Ride 290	11-19										
300	SC300	19-19										
300	SCF300	19-19										
300	SE-R 3,0	13-16			WF4511	119,50€						
300	SE-R 3,0 i	10-12										
300	SE-R 300	15-20			WF4511	119,50€						
300	SE-R 300	21-22										
300	SE-R 300 Factory	13-22										
300	SEF-R 300 4T	14-20			WF4511	119,50€						
300	SEF-R 300 4T	21-22										
300	SEF-R 300 4T Factory	14-22										
300	ST 3,0 Factory	14-16										
300	ST 3.0 2T	13-17										
300	ST 3.0R 2T	13-14										
300	ST 300	18-22										
320	Sherco 3.2 320	03-08										
320	ST 3.2-F 320	09-13										
450	Enduro 4.5i 450	04-04			SH01RID	132,80€						
450	Enduro 4.5i 450	05-08			SH01RID	132,80€						
450	SCF450	19-19										
450	SE 4.5i-F 450	09-13										
450	SEF-R 450	17-20			WF4511	119,50€						
450	SEF-R 450	21-21										
450	SEF-R 450 Factory	16-21										
450	SM 4.5i-F 450	09-13										
450	Supermotard 4.5i 450	05-05			SH01RID	132,80€						
450	Supermotard 4.5i 450	06-08			SH01RID	132,80€						
500	SCF500	19-19										
500	SEF-R 500	20-20			WF4511	119,50€						
500	SEF-R 500	21-21										
500	SEF-R 500 Factory	20-21										
510	Enduro 5.1i 510	06-08			SH01RID	132,80€						
510	SE 5.1i-F 510	09-11										
510	SM 5.1i-F 510	09-13										
510	Supermotard 5.1i 510	07-08										
SUZUKI												
50	JR 50	04-07										
50	JR 80	01-01										
50	LT50	84-99										
50	LT50 A Quadmaster	02-15										
50	LT50 L	98-03										
50	LT50 Z Quadsport	15-20										
65	RM65	03-06	KW32RID	113,30€	KW32RID	113,30€						
70	DR-Z 70 L	12-18										
80	LT80 Quadsport	89-10										
80	RM80	80-81										
80	RM80	82-82										
80	RM80 H	83-85										
80	RM80	83-85										
80	RM80	86-88										
80	RM80	89-89										
80	RM80	90-95	SZ26FID	113,30€	SZ26RID	107,30€						
80	RM80	96-01	SZ26FID	113,30€	SZ26RID	107,30€						
85	RM85	02-04	SZ26FID	113,30€	SZ26RID	107,30€						
85	RM85	05-22	YA22FID	113,80€	SZ38RID	113,30€						
90	LT-Z 90	07-13										
110	DRZ110	01-07										



Cyl.	Modèle	Années	sbs		sbs		sbs		sbs	
			PLAQUETTES AV	€ T.T.C.	PLAQUETTES AR	€ T.T.C.	DISQUE AV	€ T.T.C.	DISQUE AR	€ T.T.C.
SUZUKI										
125	DR-Z 125 /L	03-15	702SI	28,40€	02017	32,30€	5085	164,50€		
125	DR-Z 125 L	16-19	702SI	28,40€	02017	32,30€	5085	164,50€		
125	DR-Z 125 L	20-22	702SI	28,40€	02017	32,30€				
125	LT 125 E,H	84-87			02016	44,40€				
125	RM125	75-78	02014	28,20€	02014	28,20€				
125	RM125	79-80	02014	28,20€	02103	35,20€				
125	RM125	81-83	02014	28,20€	02102	36,30€				
125	RM125	84-84	02108	44,40€	02102	36,30€				
125	RM125	85-86	581HF	30,90€	02102	36,30€				
125	RM125	87-87	611SI	28,40€	02102	36,30€				
125	RM125	88-88	611SI	28,40€	584SI	28,40€	5085	164,50€	5131	79,20€
125	RM125	89-91	611SI	28,40€	632SI	28,40€	5085	164,50€	5131	79,20€
125	RM125	92-95	611SI	28,40€	648SI	28,40€	5085	164,50€	5131	79,20€
125	RM125	96-98	694SI	28,40€	604SI	28,40€	5085	164,50€	5131	79,20€
125	RM125	99-99	694SI	28,40€	604SI	28,40€	5085	164,50€	5124	79,20€
125	RM125	00-05	694RSI	39,80€	604RSI	39,80€	5085	164,50€	5124	79,20€
125	RM125	06-08	694RSI	39,80€	604RSI	39,80€	5085	164,50€	5124	79,20€
125	RM125	09-13	694SI	28,40€	604SI	28,40€	5085	164,50€	5124	79,20€
160	LT160E Quadrunner	89-92	02181	36,30€	02016	44,40€				
160	LT160F Quadsport	91-04	02181	36,30€	02016	44,40€				
230	LT230 EH-EP	86-93	591ATS	28,40€	592ATS	28,40€				
230	LT230 GEF-GEG	85-86			02016	44,40€				
230	LT230 SF-SJ	85-88	591ATS	28,40€	584ATS	28,40€				
250	DR-Z 250	01-10	694SI	28,40€	648SI	28,40€	5085	164,50€		
250	LT-F 250	01-02	536ATS	28,40€						
250	LT-F 250 Ozark	02-04	536ATS	28,40€						
250	LT-Z 250 Quadsport	04-10	536ATS	28,40€						
250	LT250 EFF-EFG (4T)	85-85			02098	60,70€				
250	LT250 RF-RH	85-85	591ATS	28,40€	584ATS	28,40€				
250	LT250 RJ-RR (4temps)	88-88	591ATS	28,40€	649ATS	28,40€				
250	RM-Z 250	04-06	694RSI	39,80€	790RSI	39,80€	5292	164,50€	5106	79,20€
250	RM-Z 250	07-18	694RSI	39,80€	790RSI	39,80€	5017	131,40€	5018	79,20€
250	RM-Z 250	19-22	694RSI	39,80€	790RSI	39,80€				
250	RM250	76-78	02014	28,20€	02016	44,40€				
250	RM250	79-79	02016	44,40€						
250	RM250	80-80	02104	40,30€						
250	RM250	81-82			02102	36,30€				
250	RM250	83-83	02108	44,40€	02102	36,30€				
250	RM250	84-84	02108	44,40€	02104	40,30€				
250	RM250	85-85	581HF	30,90€	02104	40,30€				
250	RM250	86-86	582HF	30,90€	02104	40,30€				
250	RM250	87-88	611SI	28,40€	584SI	28,40€				
250	RM250	89-90	611SI	28,40€	632SI	28,40€	5085	164,50€	5131	79,20€
250	RM250	91-95	611SI	28,40€	648SI	28,40€	5085	164,50€	5131	79,20€
250	RM250	96-98	694RSI	39,80€	604RSI	39,80€	5085	164,50€	5131	79,20€
250	RM250	99-05	694RSI	39,80€	604RSI	39,80€	5085	164,50€	5123	84,10€
250	RM250	06-08	694RSI	39,80€	604RSI	39,80€	5085	164,50€	5123	84,10€
250	RMX250	89-89	611SI	28,40€	648SI	28,40€	5085	164,50€	5131	79,20€
250	RMX250	90-91	611SI	28,40€	648SI	28,40€	5085	164,50€		
250	RMX250	92-95	611SI	28,40€	648SI	28,40€	5085	164,50€	5131	79,20€
250	RMX250	96-98	694SI	28,40€	648SI	28,40€	5085	164,50€	5131	79,20€
250	RMX250	99-01	694SI	28,40€	648SI	28,40€	5085	164,50€		
300	LT-F 300 Kingquad	91-01			02052	64,70€				
300	LT-F 300 Kingquad	02-11	611ATS 638ATS	28,40€ 28,40€	02052	64,70€				

BRAKING

		BRAKING		BRAKING		BRAKING		BRAKING				
		Années	DISQUE AV WAVE	€ T.T.C.	DISQUE AR WAVE	€ T.T.C.	DISQUE AV ROND	€ T.T.C.	DISQUE AR ROND	€ T.T.C.	DISQUE 270mm OVERSIZE	€ T.T.C.
SUZUKI												
125	DR-Z 125 /L	03-15										
125	DR-Z 125 L	16-19										
125	DR-Z 125 L	20-22										
125	LT 125 E,H	84-87										
125	RM125	75-78										
125	RM125	79-80										
125	RM125	81-83										
125	RM125	84-84										
125	RM125	85-86										
125	RM125	87-87										
125	RM125	88-88	SZ01FID	142,30€	SZ01RID	113,30€	SZ01FI	130,80€				
125	RM125	89-91	SZ01FID	142,30€	SZ01RID	113,30€	SZ01FI	130,80€				
125	RM125	92-95	SZ01FID	142,30€	SZ01RID	113,30€	SZ01FI	130,80€				
125	RM125	96-98	SZ01FID	142,30€	SZ01RID	113,30€	SZ01FI	130,80€			WL4010 POW02	195,90€ 66,70€
125	RM125	99-99	SZ01FID	142,30€	SZ01RID	113,30€	SZ01FI	130,80€			WL4010 POW02	195,90€ 66,70€
125	RM125	00-05	SZ01FID	142,30€	SZ21RID	142,20€	SZ01FI	130,80€			WL4010 POW02	195,90€ 66,70€
125	RM125	06-08	SZ01FID	142,30€	SZ40RID	136,20€	SZ01FI	130,80€			WL4010 POW02	195,90€ 66,70€
125	RM125	09-13	SZ01FID	142,30€	SZ40RID	136,20€	SZ01FI	130,80€			WL4010 POW02	195,90€ 66,70€
160	LT160E Quadrunner	89-92										
160	LT160F Quadsport	91-04										
230	LT230 EH-EP	86-93										
230	LT230 GEF-GEG	85-86										
230	LT230 SF-SJ	85-88										
250	DR-Z 250	01-10										
250	LT-F 250	01-02										
250	LT-F 250 Ozark	02-04										
250	LT-Z 250 Quadsport	04-10	SZ16FID	112,00€								
250	LT250 EFF-EFG (4T)	85-85										
250	LT250 RF-RH	85-85										
250	LT250 RJ-RR (4temps)	88-88										
250	RM-Z 250	04-06	KW35FID	141,70€	KW41RID	142,20€						
250	RM-Z 250	07-18	SZ37FID	141,70€	SZ44RID	142,30€					WL4012 POW02	195,10€ 66,70€
250	RM-Z 250	19-22	WL4012	195,10€	SZ44RID	142,30€						
250	RM250	76-78										
250	RM250	79-79										
250	RM250	80-80										
250	RM250	81-82										
250	RM250	83-83										
250	RM250	84-84										
250	RM250	85-85										
250	RM250	86-86										
250	RM250	87-88										
250	RM250	89-90	SZ01FID	142,30€	SZ01RID	113,30€	SZ01FI	130,80€				
250	RM250	91-95	SZ01FID	142,30€	SZ01RID	113,30€	SZ01FI	130,80€				
250	RM250	96-98	SZ01FID	142,30€	SZ01RID	113,30€	SZ01FI	130,80€			WL4010 POW02	195,90€ 66,70€
250	RM250	99-05	SZ01FID	142,30€	SZ21RID	142,20€	SZ01FI	130,80€			WL4010 POW02	195,90€ 66,70€
250	RM250	06-08	SZ01FID	142,30€	SZ40RID	136,20€	SZ01FI	130,80€			WL4010 POW02	195,90€ 66,70€
250	RMX250	89-89	SZ01FID	142,30€	SZ21RID	142,20€	SZ01FI	130,80€				
250	RMX250	90-91	SZ01FID	142,30€			SZ01FI	130,80€				
250	RMX250	92-95	SZ01FID	142,30€	SZ01RID	113,30€	SZ01FI	130,80€				
250	RMX250	96-98	SZ01FID	142,30€	SZ01RID	113,30€	SZ01FI	130,80€				
250	RMX250	99-01	SZ01FID	142,30€			SZ01FI	130,80€				
300	LT-F 300 Kingquad	91-01										
300	LT-F 300 Kingquad	02-11										

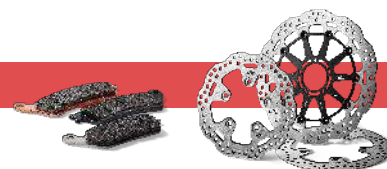

Cyl.	Modèle	Années	sbs		sbs		sbs		sbs	
			PLAQUETTES AV	€ T.T.C.	PLAQUETTES AR	€ T.T.C.	DISQUE AV	€ T.T.C.	DISQUE AR	€ T.T.C.
SUZUKI										
400	DR-Z 400 /S	00-04	694SI	28,40€	604SI	28,40€			5131	79,20€
400	DR-Z 400 /S	05-09	694HF	33,50€	604HF	33,80€			5131	79,20€
400	DR-Z 400 E	00-04	694SI	28,40€	604SI	28,40€			5131	79,20€
400	DR-Z 400 E	05-07	694HF	33,50€	604HF	33,80€			5131	79,20€
400	LT-A 400 Eiger	02-08	536ATS	28,40€	02018	48,50€				
400	LT-F 400 Eiger	03-08	536ATS	28,40€	02018	48,50€				
400	LT-Z 400 QuadSport	03-19	592ATS	28,40€	649ATS	28,40€				
400	LT400 A/F King Quad	08-15	835ATS 836ATS	28,40€ 28,40€						
400	RM400	78-78	02014	28,20€	02016	44,40€				
400	RM400	79-79	02016	44,40€						
400	RM400	80-80	02104	40,30€						
450	LT-A 450 King Quad	08-08	835ATS 836ATS	28,40€ 28,40€						
450	LT-R 450 Quadracer	06-14	611ATS 638ATS	28,40€ 28,40€	649ATS	28,40€				
450	RM-Z 450	05-17	694RSI	39,80€	790RSI	39,80€	5017	131,40€	5018	79,20€
450	RM-Z 450	18-22	694RSI	39,80€	790RSI	39,80€			5018	79,20€
450	RMX450 Z	10-15	694RSI	39,80€	790RSI	39,80€	5017	131,40€	5018	79,20€
500	LT-A 500 F Quadmaster	00-01	611ATS 638ATS	28,40€ 28,40€						
500	LT-A 500 F Vinson	02-10	536ATS	28,40€						
500	LT-A 500 King Quad	11-15	835ATS 836ATS	28,40€ 28,40€						
500	LT-F 500 F Quadrunner	98-98	638ATS	28,40€						
500	LT-F 500 F Quadrunner	99-10	638ATS 611ATS	28,40€ 28,40€						
500	RM500	83-84	02108	44,40€	02014	28,20€				
500	RM500	85-86	581HF	30,90€	02014	28,20€				
500	RM500	87-87	611SI	28,40€	592SI	28,40€				
700	LT-A 700 King Quad	05-10	835ATS 836ATS	28,40€ 28,40€						
700	LT-V 700 Quadrunner	04-10	801ATS 798ATS	28,40€ 28,40€						
750	LT-A750 King Quad	15-15	835ATS 836ATS	28,40€ 28,40€						
TM										
85	Cross 85 (19"/16")	02-05	671SI	28,40€	604SI	28,40€				
85	Enduro 85 (19"/16")	02-05	671SI	28,40€	604SI	28,40€				
85	MX	16-17	671RSI	39,80€	777RSI	39,80€				
85	MX	18-19	777RSI	39,80€	777RSI	39,80€				
85	MX Junior	14-21	777RSI	39,80€	777RSI	39,80€				
125	Cross MX125	98-04	671SI	28,40€	675SI	28,40€	5294	164,50€		
125	Cross MX125	05-09	671RSI	39,80€	790RSI	39,80€	5294	164,50€		
125	Cross MX125	10-15	671RSI	39,80€	790RSI	39,80€	5294	164,50€	5296	79,20€
125	Cross MX125	16-17	671RSI	39,80€	790RSI	39,80€	5294	164,50€		
125	Cross MX125	18-22	671RSI	39,80€	790RSI	39,80€	5295	164,50€		
125	Enduro 125	98-03	671SI	28,40€	675SI	28,40€	5294	164,50€		
125	Enduro 125	04-04	671SI	28,40€	604SI	28,40€	5294	164,50€		
125	Enduro EN125	05-08	671SI	28,40€	790SI	28,40€	5294	164,50€		
125	Enduro EN125	09-15	671SI	28,40€	790SI	28,40€	5294	164,50€	5296	79,20€
125	Enduro EN125	16-19	671SI	28,40€	790SI	28,40€	5294	164,50€		
125	Enduro EN125 FI	20-22	671SI	28,40€	790SI	28,40€	5294	164,50€		
125	SMR125	05-10	566RSI	39,80€	604RSI	39,80€				
250	Cross 250 /F	01-02	671SI	28,40€	604SI	28,40€				
250	Cross 250 /F	03-03	671SI	28,40€	675SI	28,40€	5294	164,50€		
250	Cross 250 /F	04-04	671SI	28,40€	604SI	28,40€	5294	164,50€		
250	Cross 250 /F	05-10	671RSI	39,80€	790RSI	39,80€	5294	164,50€		
250	Cross 250 /F	11-13	671RSI	39,80€	790RSI	39,80€	5294	164,50€	5296	79,20€
250	Cross MX 250 2 temps	14-16	671RSI	39,80€	790RSI	39,80€	5294	164,50€	5296	79,20€

BRAKING

		BRAKING		BRAKING		BRAKING		BRAKING		BRAKING		
		Années	DISQUE AV WAVE	€ T.T.C.	DISQUE AR WAVE	€ T.T.C.	DISQUE AV ROND	€ T.T.C.	DISQUE AR ROND	€ T.T.C.	DISQUE 270mm OVERSIZE	€ T.T.C.
SUZUKI												
400	DR-Z 400 /S	00-04	SZ01FID	142,30€	SZ01RID	113,30€	SZ01FI	130,80€			WL4010 POW02	195,90€ 66,70€
400	DR-Z 400 /S	05-09	SZ01FID	142,30€	SZ01RID	113,30€	SZ01FI	130,80€			WL4010 POW02	195,90€ 66,70€
400	DR-Z 400 E	00-04	SZ01FID	142,30€	SZ01RID	113,30€	SZ01FI	130,80€			WL4010 POW02	195,90€ 66,70€
400	DR-Z 400 E	05-07	SZ01FID	142,30€	SZ01RID	113,30€	SZ01FI	130,80€			WL4010 POW02	195,90€ 66,70€
400	LT-A 400 Eiger	02-08										
400	LT-F 400 Eiger	03-08										
400	LT-Z 400 QuadSport	03-19	SZ16FID	112,00€	HO47RID	112,40€						
400	LT400 A/F King Quad	08-15										
400	RM400	78-78										
400	RM400	79-79										
400	RM400	80-80										
450	LT-A 450 King Quad	08-08										
450	LT-R 450 Quadracer	06-14	SZ43FID	112,00€	SZ43RID	112,00€						
450	RM-Z 450	05-17	SZ37FID	141,70€	SZ44RID	142,30€					WL4012 POW02	195,10€ 66,70€
450	RM-Z 450	18-22	WL4012	195,10€	SZ44RID	142,30€						
450	RMX450 Z	10-15	SZ37FID	141,70€	SZ44RID	142,30€					WL4012 POW02	195,10€ 66,70€
500	LT-A 500 F Quadmaster	00-01										
500	LT-A 500 F Vinson	02-10										
500	LT-A 500 King Quad	11-15										
500	LT-F 500 F Quadrunner	98-98										
500	LT-F 500 F Quadrunner	99-10										
500	RM500	83-84										
500	RM500	85-86										
500	RM500	87-87										
700	LT-A 700 King Quad	05-10										
700	LT-V 700 Quadrunner	04-10										
750	LT-A750 King Quad	15-15										
TM												
85	Cross 85 (19"/16")	02-05										
85	Enduro 85 (19"/16")	02-05										
85	MX	16-17										
85	MX	18-19										
85	MX Junior	14-21										
125	Cross MX125	98-04	WL4014	195,10€								
125	Cross MX125	05-09	WL4014	195,10€								
125	Cross MX125	10-15	WL4014	195,10€								
125	Cross MX125	16-17	WL4014	195,10€								
125	Cross MX125	18-22										
125	Enduro 125	98-03	WL4014	195,10€								
125	Enduro 125	04-04	WL4014	195,10€								
125	Enduro EN125	05-08	WL4014	195,10€								
125	Enduro EN125	09-15	WL4014	195,10€								
125	Enduro EN125	16-19	WL4014	195,10€								
125	Enduro EN125 FI	20-22	WL4014	195,10€								
125	SMR125	05-10										
250	Cross 250 /F	01-02										
250	Cross 250 /F	03-03	WL4014	195,10€								
250	Cross 250 /F	04-04	WL4014	195,10€								
250	Cross 250 /F	05-10	WL4014	195,10€								
250	Cross 250 /F	11-13	WL4014	195,10€								
250	Cross MX 250 2 temps	14-16	WL4014	195,10€								



Cyl.	Modèle	Années	sbs		sbs		sbs		sbs	
			PLAQUETTES AV	€ T.T.C.	PLAQUETTES AR	€ T.T.C.	DISQUE AV	€ T.T.C.	DISQUE AR	€ T.T.C.
TM										
250	Cross MX 250 2 temps	17-17	671RSI	39,80€	790RSI	39,80€	5295	164,50€		
250	Cross MX 250 2 temps	18-22	671RSI	39,80€	790RSI	39,80€	5295	164,50€		
250	Cross MX 250 Fi 4 temps	14-17	671RSI	39,80€	790RSI	39,80€	5294	164,50€	5296	79,20€
250	Cross MX 250 Fi 4 temps	18-22	671RSI	39,80€	790RSI	39,80€	5295	164,50€		
250	Enduro 250 /F	01-02	671SI	28,40€	675SI	28,40€	5294	164,50€		
250	Enduro 250 /F	03-04	671SI	28,40€	604SI	28,40€	5294	164,50€		
250	Enduro 250 /F	05-09	671SI	28,40€	790SI	28,40€	5294	164,50€		
250	Enduro 250 /F	10-13	671SI	28,40€	790SI	28,40€	5294	164,50€	5296	79,20€
250	Enduro EN 250 2 temps	14-15	671SI	28,40€	790SI	28,40€	5294	164,50€	5296	79,20€
250	Enduro EN 250 2 temps	16-17	671SI	28,40€	790SI	28,40€	5294	164,50€		
250	Enduro EN 250 2 temps	18-22	671SI	28,40€	790SI	28,40€	5295	164,50€		
250	Enduro EN 250 4 temps	14-17	671SI	28,40€	790SI	28,40€	5294	164,50€		
250	Enduro EN 250 4 temps	18-22	671SI	28,40€	790SI	28,40€	5295	164,50€		
250	Enduro EN 250 Fi 2 temps	19-22	671SI	28,40€	790SI	28,40€	5295	164,50€		
300	Cross 300	01-01	671SI	28,40€	790SI	28,40€				
300	Cross 300	02-04	671SI	28,40€	675SI	28,40€				
300	Cross 300	05-13	671RSI	39,80€	790RSI	39,80€	5294	164,50€		
300	Cross MX 300 2 temps	14-17	671RSI	39,80€	790RSI	39,80€	5294	164,50€		
300	Cross MX 300 2 temps	18-22	671RSI	39,80€	790RSI	39,80€	5295	164,50€		
300	Enduro 300	01-01	671SI	28,40€	604SI	28,40€				
300	Enduro 300	02-02	671SI	28,40€	675SI	28,40€				
300	Enduro 300	03-04	671SI	28,40€	604SI	28,40€				
300	Enduro 300	05-09	671SI	28,40€	790SI	28,40€				
300	Enduro 300	10-13	671SI	28,40€	790SI	28,40€	5294	164,50€		
300	Enduro EN 300 2 temps	14-22	671SI	28,40€	790SI	28,40€	5295	164,50€		
300	Enduro EN 300 4 temps	14-22	671SI	28,40€	790SI	28,40€	5295	164,50€		
300	Enduro EN 300 Fi 2 temps	19-22	671SI	28,40€	790SI	28,40€	5295	164,50€		
400	Cross 400	02-10	671SI	28,40€	604SI	28,40€				
400	Enduro 400	01-01	671SI	28,40€	604SI	28,40€				
400	SMF400 F	02-02	566RSI	39,80€	604RSI	39,80€				
400	SMR400 F	03-03	566RSI	39,80€	604RSI	39,80€				
450	Cross 450 F	02-04	671RSI	39,80€	604SI	28,40€				
450	Cross 450 F	05-05	671RSI	39,80€	790RSI	39,80€				
450	Cross 450 F	06-09	671RSI	39,80€	790RSI	39,80€	5294	164,50€		
450	Cross 450 F	10-16	671RSI	39,80€	790RSI	39,80€	5294	164,50€	5296	79,20€
450	Cross 450 F	17-17	671RSI	39,80€	790RSI	39,80€	5294	164,50€		
450	Cross 450 F	18-22	671RSI	39,80€	790RSI	39,80€	5295	164,50€		
450	Enduro 450 F	02-04	671SI	28,40€	604SI	28,40€				
450	Enduro 450 F	05-09	671SI	28,40€	790SI	28,40€	5294	164,50€		
450	Enduro 450 F	10-15	671SI	28,40€	790SI	28,40€	5294	164,50€	5296	79,20€
450	Enduro 450 F	16-16	671SI	28,40€	790SI	28,40€	5294	164,50€		
450	Enduro 450 F	17-22	671SI	28,40€	790SI	28,40€	5295	164,50€		
450	SMR450 F	04-17	566RSI	39,80€	604RSI	39,80€				
450	SMX450 F	03-14	762081	74,50€	604SI	28,40€				
530	Cross 530 F	01-04	671SI	28,40€	604SI	28,40€				
530	Cross 530 F	05-09	671SI	28,40€	790SI	28,40€	5294	164,50€		
530	Cross 530 F	10-11	671SI	28,40€	790SI	28,40€	5294	164,50€	5296	79,20€
530	Enduro 530 F	01-04	671SI	28,40€	604SI	28,40€				
530	Enduro 530 F	05-09	671SI	28,40€	790SI	28,40€	5294	164,50€		
530	Enduro 530 F	10-14	671SI	28,40€	790SI	28,40€	5294	164,50€	5296	79,20€
530	Enduro 530 F	19-21	671SI	28,40€	790SI	28,40€	5295	164,50€		
530	SMR530 F	03-17	566RSI	39,80€	604RSI	39,80€				
600	SMX600 F	03-11	566RSI	39,80€	604RSI	39,80€				
660	SMX660 F	04-11	762081	74,50€	604SI	28,40€				
VOR										
400	EN400	02-02	671SI	28,40€	675SI	28,40€				
400	MX400	02-02	671SI	28,40€	675SI	28,40€				
400	SM400	02-02	706RS	48,40€	675HF	33,50€				
450	EN450	02-02	671SI	28,40€	675SI	28,40€				

BRAKING

TM		Années	BRAKING [®]		BRAKING [®]		BRAKING [®]		BRAKING [®]	
			DISQUE AV WAVE	€ T.T.C.	DISQUE AR WAVE	€ T.T.C.	DISQUE AV ROND	€ T.T.C.	DISQUE AR ROND	€ T.T.C.
250	Cross MX 250 2 temps	17-17	WL4014	195,10€						
250	Cross MX 250 2 temps	18-22								
250	Cross MX 250 Fi 4 temps	14-17	WL4014	195,10€						
250	Cross MX 250 Fi 4 temps	18-22								
250	Enduro 250 /F	01-02	WL4014	195,10€						
250	Enduro 250 /F	03-04	WL4014	195,10€						
250	Enduro 250 /F	05-09	WL4014	195,10€						
250	Enduro 250 /F	10-13	WL4014	195,10€						
250	Enduro EN 250 2 temps	14-15	WL4014	195,10€						
250	Enduro EN 250 2 temps	16-17	WL4014	195,10€						
250	Enduro EN 250 2 temps	18-22								
250	Enduro EN 250 4 temps	14-17	WL4014	195,10€						
250	Enduro EN 250 4 temps	18-22								
250	Enduro EN 250 Fi 2 temps	19-22								
300	Cross 300	01-01								
300	Cross 300	02-04								
300	Cross 300	05-13	WL4014	195,10€						
300	Cross MX 300 2 temps	14-17	WL4014	195,10€						
300	Cross MX 300 2 temps	18-22								
300	Enduro 300	01-01								
300	Enduro 300	02-02								
300	Enduro 300	03-04								
300	Enduro 300	05-09								
300	Enduro 300	10-13								
300	Enduro EN 300 2 temps	14-22								
300	Enduro EN 300 4 temps	14-22								
300	Enduro EN 300 Fi 2 temps	19-22								
400	Cross 400	02-10								
400	Enduro 400	01-01								
400	SMF400 F	02-02								
400	SMR400 F	03-03								
450	Cross 450 F	02-04								
450	Cross 450 F	05-05								
450	Cross 450 F	06-09	WL4014	195,10€						
450	Cross 450 F	10-16	WL4014	195,10€						
450	Cross 450 F	17-17	WL4014	195,10€						
450	Cross 450 F	18-22								
450	Enduro 450 F	02-04								
450	Enduro 450 F	05-09	WL4014	195,10€						
450	Enduro 450 F	10-15	WL4014	195,10€						
450	Enduro 450 F	16-16	WL4014	195,10€						
450	Enduro 450 F	17-22								
450	SMR450 F	04-17								
450	SMX450 F	03-14								
530	Cross 530 F	01-04								
530	Cross 530 F	05-09	WL4014	195,10€						
530	Cross 530 F	10-11	WL4014	195,10€						
530	Enduro 530 F	01-04								
530	Enduro 530 F	05-09	WL4014	195,10€						
530	Enduro 530 F	10-14	WL4014	195,10€						
530	Enduro 530 F	19-21								
530	SMR530 F	03-17								
600	SMX600 F	03-11								
660	SMX660 F	04-11								
VOR										
400	EN400	02-02								
400	MX400	02-02								
400	SM400	02-02								
450	EN450	02-02								



Cyl.	Modèle	Années	sbs		sbs		sbs		sbs	
			PLAQUETTES AV	€ T.T.C.	PLAQUETTES AR	€ T.T.C.	DISQUE AV	€ T.T.C.	DISQUE AR	€ T.T.C.
VOR										
450	MX450	02-02	671RSI	39,80€	675RSI	39,90€				
450	SM450	02-02	566RSI	39,80€	675RSI	39,90€				
530	EN530	02-02	671SI	28,40€	675SI	28,40€				
530	MX530	02-02	671SI	28,40€	675SI	28,40€				
530	SM530	02-02	566HS	40,40€	675HF	33,50€				
YAMAHA										
50	PW50	80-21	02112	21,30€	02112	21,30€				
50	TT-R50 E	18-22	02010	24,10€	02010	24,10€				
50	TY50 M	77-80	02032	26,30€	02032	26,30€				
60	YZ60	85-85	02182	26,30€	02182	26,30€				
65	YZ 65	18-22	589RSI	39,80€	592RSI	39,80€			5134	54,80€
80	PW80	83-90	02182	26,30€	02050	28,20€				
80	PW80	91-13	02182	26,30€	02028	28,30€				
80	YFM80 Badger	95-01	02028	28,30€	02034	28,20€				
80	YFM80 Raptor	02-07	02028	28,30€	02034	28,20€				
80	YZ80	74-79	02182	26,30€	02032	26,30€				
80	YZ80	80-85	02182	26,30€	02182	26,30€				
80	YZ80	86-92	589RSI	39,80€	02182	26,30€				
80	YZ80	93-01	589RSI	39,80€	592RSI	39,80€	5255	73,10€	5134	54,80€
85	YZ85	02-22	589RSI	39,80€	592RSI	39,80€	5255	73,10€	5134	54,80€
90	TT90 R	00-03	02182	26,30€	02028	28,30€				
90	YFM 90 Raptor	09-16	02028	28,30€	586ATS	28,40€				
100	RT100	90-90	02028	28,30€	02028	28,30€				
110	TT-R110 E	08-22	02182	26,30€	02028	28,30€				
125	TT125 R (17"/14")	00-04	02028	28,30€	02028	28,30€				
125	TT125 R (19"/16")	00-22	589HF	22,60€	02028	28,30€				
125	TY125	80-82	02032	26,30€	02034	28,20€				
125	WR125	91-97	611SI	28,40€	632SI	28,40€	5123	84,10€	5091	84,10€
125	WR125	98-00	694SI	28,40€	604SI	28,40€	5123	84,10€		
125	WR125	01-01	694SI	28,40€	604SI	28,40€				
125	WR125	02-03	694SI	28,40€	604SI	28,40€				
125	YFA125 Breeze	89-04	02028	28,30€	02034	28,20€				
125	YFM125 Grizzly	04-13	02028	28,30€	02034	28,20€				
125	YZ125	76-82	02033	36,30€	02034	28,20€				
125	YZ125	83-83	02033	36,30€	02049	36,30€				
125	YZ125	84-84	02036	36,30€	02049	36,30€				
125	YZ125	85-87	580SI	28,40€	02049	36,30€				
125	YZ125	88-88	580SI	28,40€	575SI	28,40€	5126	79,20€	5091	84,10€
125	YZ125	89-89	611SI	28,40€	584SI	28,40€	5126	79,20€	5091	84,10€
125	YZ125	90-96	611SI	28,40€	632SI	28,40€	5123	84,10€	5091	84,10€
125	YZ125	97-97	611SI	28,40€	648SI	28,40€	5123	84,10€	5091	84,10€
125	YZ125	98-00	694RSI	39,80€	604SI	28,40€	5123	84,10€	5091	84,10€
125	YZ125	01-01	694RSI	39,80€	604SI	28,40€	5123	84,10€	5091	84,10€
125	YZ125	02-02	694RSI	39,80€	604SI	28,40€	5085	164,50€	5103	96,20€
125	YZ125	03-07	694RSI	39,80€	790RSI	39,80€	5085	164,50€	5103	96,20€
125	YZ125	08-18	840RSI	39,80€	790RSI	39,80€	5085	164,50€	5103	96,20€
125	YZ125	19-21	840RSI	39,80€	790RSI	39,80€	5248	164,50€		
125	YZ125	22-22	965RSI	39,80€	790RSI	39,80€	5248	164,50€		
200	WR200 R	91-97	611SI	28,40€	632SI	28,40€				
200	YFS200 Blaster	88-02	02028	28,30€	637ATS	43,70€				
200	YFS200 Blaster	03-06	536ATS	28,40€	592ATS	28,40€				
225	TT225R	01-01	575SI	28,40€	02028	28,30€				
230	TT230R	05-16	611SI	28,40€	02034	28,20€				
250	TT250 R	87-92	580SI	28,40€	02034	28,20€				
250	TT250 R	93-99	611SI	28,40€	632SI	28,40€			5091	84,10€
250	TT250 R	00-07	611SI	28,40€	632SI	28,40€				

BRAKING

		BRAKING		BRAKING		BRAKING		BRAKING		BRAKING		
		Années	DISQUE AV WAVE	€ T.T.C.	DISQUE AR WAVE	€ T.T.C.	DISQUE AV ROND	€ T.T.C.	DISQUE AR ROND	€ T.T.C.	DISQUE 270mm OVERSIZE	€ T.T.C.
VOR												
450	MX450	02-02										
450	SM450	02-02										
530	EN530	02-02										
530	MX530	02-02										
530	SM530	02-02										
YAMAHA												
50	PW50	80-21										
50	TT-R50 E	18-22										
50	TY50 M	77-80										
60	YZ60	85-85										
65	YZ 65	18-22	WF4106	138,20€	YA22RID	113,30€						
80	PW80	83-90										
80	PW80	91-13										
80	YFM80 Badger	95-01										
80	YFM80 Raptor	02-07										
80	YZ80	74-79										
80	YZ80	80-85										
80	YZ80	86-92	KW18RID	113,30€	KW18RID	113,30€						
80	YZ80	93-01	YA22FID	113,80€	YA22RID	113,30€						
85	YZ85	02-22	YA22FID	113,80€	YA22RID	113,30€						
90	TT90 R	00-03										
90	YFM 90 Raptor	09-16										
100	RT100	90-90										
110	TT-R110 E	08-22										
125	TT125 R (17"/14")	00-04										
125	TT125 R (19"/16")	00-22										
125	TY125	80-82										
125	WR125	91-97			YA01RID	113,30€			YA01RI	99,70€		
125	WR125	98-00			YA10RID	141,70€			YA10RI	107,88€		
125	WR125	01-01	SZ01FID	142,30€	YA10RID	141,70€	SZ01FI	130,80€	YA10RI	107,88€	WL4010 POW04	195,90€ 65,80€
125	WR125	02-03	SZ01FID	142,30€	YA52RID	135,40€	SZ01FI	130,80€			WL4010 POW04	195,90€ 65,80€
125	YFA125 Breeze	89-04										
125	YFM125 Grizzly	04-13										
125	YZ125	76-82										
125	YZ125	83-83										
125	YZ125	84-84										
125	YZ125	85-87										
125	YZ125	88-88			YA01RID	113,30€			YA01RI	99,70€		
125	YZ125	89-89			YA01RID	113,30€			YA01RI	99,70€		
125	YZ125	90-96			YA01RID	113,30€			YA01RI	99,70€		
125	YZ125	97-97			YA01RID	113,30€			YA01RI	99,70€		
125	YZ125	98-00			YA10RID	141,70€			YA10RI	107,88€	WL4010 POW04	195,90€ 65,80€
125	YZ125	01-01	SZ01FID	142,30€	YA10RID	141,70€	SZ01FI	130,80€	YA10RI	107,88€	WL4010 POW04	195,90€ 65,80€
125	YZ125	02-02	SZ01FID	142,30€	YA52RID	135,40€	SZ01FI	130,80€			WL4010 POW04	195,90€ 65,80€
125	YZ125	03-07	SZ01FID	142,30€	YA52RID	135,40€	SZ01FI	130,80€			WL4010 POW04	195,90€ 65,80€
125	YZ125	08-18	SZ01FID	142,30€	YA52RID	135,40€	SZ01FI	130,80€			WL4010 POW78	195,90€ 65,81€
125	YZ125	19-21	WL4010	195,90€	WF4512	138,20€	SZ01FI	130,80€				
125	YZ125	22-22	WL4010	195,90€	WF4512	130,80€						
200	WR200 R	91-97			YA01RID	113,30€			YA01RI	99,70€		
200	YFS200 Blaster	88-02			YA30RID	104,46€						
200	YFS200 Blaster	03-06	YA30FID	112,40€	YA30RID	104,46€						
225	TT225R	01-01										
230	TT230R	05-16										
250	TT250 R	87-92										
250	TT250 R	93-99			YA01RID	113,30€			YA01RI	99,70€		
250	TT250 R	00-07										



Cyl.	Modèle	Années	sbs		sbs		sbs		sbs	
			PLAQUETTES AV	€ T.T.C.	PLAQUETTES AR	€ T.T.C.	DISQUE AV	€ T.T.C.	DISQUE AR	€ T.T.C.
YAMAHA										
250	WR250	89-89	611SI	28,40€	632SI	28,40€				
250	WR250	90-97	611SI	28,40€	632SI	28,40€			5091	84,10€
250	WR250	98-02	694SI	28,40€	604SI	28,40€	5123	84,10€	5091	84,10€
250	WR250 F	01-01	694SI	28,40€	604SI	28,40€	5085	164,50€	5091	84,10€
250	WR250 F	02-02	694SI	28,40€	604SI	28,40€	5085	164,50€	5103	96,20€
250	WR250 F	03-17	694SI	28,40€	790SI	28,40€	5085	164,50€	5103	96,20€
250	WR250 F	18-18	840SI	28,40€	790SI	28,40€	5085	164,50€	5103	96,20€
250	WR250 F	19-21	840SI	28,40€	790SI	28,40€	5085	164,50€		
250	WR250 F	22-22	840SI	28,40€	790SI	28,40€	5248	164,50€		
250	WR250 Z	91-97	694SI	28,40€	790SI	28,40€			5091	84,10€
250	WR250 Z	98-00	694SI	28,40€	790SI	28,40€				
250	WR250 Z	01-01	694SI	28,40€	790SI	28,40€				
250	WR250 Z	02-05	694SI	28,40€	790SI	28,40€				
250	XG250 Tricker	05-06	728HF	30,90€	632HF	30,90€				
250	YFM250 AN Bruin	05-06	536ATS	28,40€						
250	YFM250 Bear Tracker	00-05	536ATS	28,40€						
250	YFM250 R Raptor	08-13	850ATS 849ATS	28,40€ 28,40€	592ATS	28,40€				
250	YFM250 Timberwolf	95-99	02035	48,50€	02035	48,50€				
250	YZ250	80-80	02033	36,30€	02034	28,20€				
250	YZ250	81-81	02033	36,30€	02037	44,40€				
250	YZ250	82-84	02036	36,30€	02034	28,20€				
250	YZ250	85-87	580SI	28,40€	02034	28,20€			5091	84,10€
250	YZ250	88-88	580SI	28,40€	575SI	28,40€			5091	84,10€
250	YZ250	89-89	611SI	28,40€	584SI	28,40€			5091	84,10€
250	YZ250	90-91	611SI	28,40€	632SI	28,40€			5091	84,10€
250	YZ250	92-93	611SI	28,40€	648SI	28,40€	5123	84,10€	5091	84,10€
250	YZ250	94-97	611SI	28,40€	648SI	28,40€	5123	84,10€	5091	84,10€
250	YZ250	98-99	694RSI	39,80€	604SI	28,40€	5123	84,10€		
250	YZ250	00-00	694SI	28,40€	604SI	28,40€	5123	84,10€		
250	YZ250	01-01	694SI	28,40€	604SI	28,40€	5085	164,50€	5103	96,20€
250	YZ250	02-02	694RSI	39,80€	604SI	28,40€	5085	164,50€	5103	96,20€
250	YZ250	03-07	694RSI	39,80€	790RSI	39,80€	5085	164,50€	5103	96,20€
250	YZ250	08-18	840RSI	39,80€	790RSI	39,80€	5085	164,50€	5103	96,20€
250	YZ250	19-21	840RSI	39,80€	790RSI	39,80€	5248	164,50€	5103	96,20€
250	YZ250	22-22	965RSI	39,80€	790RSI	39,80€	5248	164,50€		
250	YZ250 F	01-01	694RSI	39,80€	604SI	28,40€	5085	164,50€		
250	YZ250 F	02-02	694RSI	39,80€	604SI	28,40€	5085	164,50€	5103	96,20€
250	YZ250 F	03-06	694RSI	39,80€	790RSI	39,80€	5085	164,50€	5103	96,20€
250	YZ250 F	07-15	840RSI	39,80€	790RSI	39,80€	5085	164,50€	5103	96,20€
250	YZ250 F	16-18	840RSI	39,80€	790RSI	39,80€	5248	164,50€	5103	96,20€
250	YZ250 F	19-20	840RSI	39,80€	790RSI	39,80€	5248	164,50€		
250	YZ250 F	21-22	965RSI	39,80€	790RSI	39,80€	5248	164,50€		
250	YZ250 X	16-17	840RSI	39,80€	790RSI	39,80€	5085	164,50€	5103	96,20€
250	YZ250 X	18-19	840RSI	39,80€	790RSI	39,80€				
350	TT350	86-86	580SI	28,40€	02034	28,20€	5126	79,20€		
350	TT350	87-87	580SI	28,40€	02034	28,20€				
350	TT350	88-94	580SI	28,40€	02034	28,20€				
350	TT350	95-97	611SI	28,40€	632SI	28,40€				



		BRAKING		BRAKING		BRAKING		BRAKING		BRAKING		
		Années	DISQUE AV WAVE	€ T.T.C.	DISQUE AR WAVE	€ T.T.C.	DISQUE AV ROND	€ T.T.C.	DISQUE AR ROND	€ T.T.C.	DISQUE 270mm OVERSIZE	€ T.T.C.
YAMAHA												
250	WR250	89-89										
250	WR250	90-97			YA01RID	113,30€			YA01RI	99,70€		
250	WR250	98-02			YA10RID	141,70€			YA10RI	107,88€	WL4010 POW04	195,90€ 65,80€
250	WR250 F	01-01	SZ01FID	142,30€	YA10RID	141,70€	SZ01FI	130,80€	YA10RI	107,88€	WL4010 POW04	195,90€ 65,80€
250	WR250 F	02-02	SZ01FID	142,30€	YA52RID	135,40€	SZ01FI	130,80€			WL4010 POW04	195,90€ 65,80€
250	WR250 F	03-17	SZ01FID	142,30€	YA52RID	135,40€	SZ01FI	130,80€			WL4010 POW04	195,90€ 65,80€
250	WR250 F	18-18	SZ01FID	142,30€	YA52RID	135,40€	SZ01FI	130,80€			WL4010 POW04	195,90€ 65,80€
250	WR250 F	19-21	SZ01FID	142,30€	WF4512	130,80€	SZ01FI	130,80€			WL4010 POW04	195,90€ 65,80€
250	WR250 F	22-22	WL4010	195,90€	WF4512	130,80€						
250	WR250 Z	91-97			YA01RID	113,30€			YA01RI	99,70€		
250	WR250 Z	98-00			YA10RID	141,70€			YA10RI	107,88€	WL4010 POW04	195,90€ 65,80€
250	WR250 Z	01-01	SZ01FID	142,30€	YA10RID	141,70€	SZ01FI	130,80€	YA10RI	107,88€	WL4010 POW04	195,90€ 65,80€
250	WR250 Z	02-05	SZ01FID	142,30€	YA52RID	135,40€	SZ01FI	130,80€			WL4010 POW04	195,90€ 65,80€
250	XG250 Tricker	05-06	YA39FID	114,80€			YA39FI	88,20€				
250	YFM250 AN Bruin	05-06										
250	YFM250 Bear Tracker	00-05	YA30FID	112,40€								
250	YFM250 R Raptor	08-13	YA30FID	112,40€	YA43RID	112,00€						
250	YFM250 Timberwolf	95-99										
250	YZ250	80-80										
250	YZ250	81-81										
250	YZ250	82-84										
250	YZ250	85-87					YA06FI	113,40€				
250	YZ250	88-88			YA01RID	113,30€	YA06FI	113,40€	YA01RI	99,70€		
250	YZ250	89-89			YA01RID	113,30€	YA06FI	113,40€	YA01RI	99,70€		
250	YZ250	90-91			YA01RID	113,30€			YA01RI	99,70€		
250	YZ250	92-93			YA01RID	113,30€			YA01RI	99,70€		
250	YZ250	94-97			YA01RID	113,30€			YA01RI	99,70€	WL4010 POW04	195,90€ 65,80€
250	YZ250	98-99			YA10RID	141,70€			YA10RI	107,88€	WL4010 POW04	195,90€ 65,80€
250	YZ250	00-00			YA10RID	141,70€			YA10RI	107,88€	WL4010 POW04	195,90€ 65,80€
250	YZ250	01-01	SZ01FID	142,30€	YA52RID	135,40€	SZ01FI	130,80€			WL4010 POW04	195,90€ 65,80€
250	YZ250	02-02	SZ01FID	142,30€	YA52RID	135,40€	SZ01FI	130,80€			WL4010 POW04	195,90€ 65,80€
250	YZ250	03-07	SZ01FID	142,30€	YA52RID	135,40€	SZ01FI	130,80€			WL4010 POW04	195,90€ 65,80€
250	YZ250	08-18	SZ01FID	142,30€	YA52RID	135,40€	SZ01FI	130,80€			WL4010 POW78	195,90€ 65,81€
250	YZ250	19-21	WL4010	195,90€	YA52RID	135,40€	SZ01FI	130,80€				
250	YZ250	22-22	WL4010	195,90€	WF4512	130,80€						
250	YZ250 F	01-01	SZ01FID	142,30€	YA10RID	141,70€	SZ01FI	130,80€	YA10RI	107,88€	WL4010 POW04	195,90€ 65,80€
250	YZ250 F	02-02	SZ01FID	142,30€	YA52RID	135,40€	SZ01FI	130,80€			WL4010 POW04	195,90€ 65,80€
250	YZ250 F	03-06	SZ01FID	142,30€	YA52RID	135,40€	SZ01FI	130,80€			WL4010 POW04	195,90€ 65,80€
250	YZ250 F	07-15	SZ01FID	142,30€	YA52RID	135,40€	SZ01FI	130,80€			WL4010 POW78	195,90€ 65,81€
250	YZ250 F	16-18	WL4010	195,90€	YA52RID	135,40€						
250	YZ250 F	19-20	WL4010	195,90€	WF4512	130,80€						
250	YZ250 F	21-22	WL4010	195,90€	WF4512	130,80€						
250	YZ250 X	16-17	SZ01FID	142,30€	YA52RID	135,40€	SZ01FI	130,80€				
250	YZ250 X	18-19										
350	TT350	86-86					YA06FI	113,40€				
350	TT350	87-87					YA06FI	113,40€				
350	TT350	88-94										
350	TT350	95-97										



Cyl.	Modèle	Années	sbs		sbs		sbs		sbs	
			PLAQUETTES AV	€ T.T.C.	PLAQUETTES AR	€ T.T.C.	DISQUE AV	€ T.T.C.	DISQUE AR	€ T.T.C.
YAMAHA										
350	YFM350 Bruin	04-05	536ATS	28,40€	02066	48,50€				
350	YFM350 Bruin	06-06	536ATS	28,40€	592ATS 02066	28,40€ 48,50€				
350	YFM350 FX Wolverine	95-04	536ATS	28,40€	592ATS	28,40€				
350	YFM350 Grizzly	07-18	536ATS	28,40€	02066	48,50€				
350	YFM350 R Raptor	04-16	592ATS	28,40€	592ATS	28,40€				
350	YFM350 X Warrior	87-88	575ATS	28,40€	592ATS	28,40€				
350	YFM350 X Warrior	89-94	536ATS	28,40€	536ATS	28,40€				
350	YFM350 X Warrior	95-04	536ATS	28,40€	592ATS	28,40€				
350	YFZ350 Banshee	90-05	536ATS	28,40€	592ATS	28,40€				
400	WR400 F	98-98	694SI	28,40€	648SI	28,40€	5123	84,10€	5091	84,10€
400	WR400 F	99-01	694SI	28,40€	604SI	28,40€	5123	84,10€	5091	84,10€
400	YFM400 FA Kodiak	00-05	536ATS	28,40€	754ATS	28,40€				
400	YFM400 FP Big Bear	03-05	536ATS	28,40€	754ATS	28,40€				
400	YFM400 FW Big Bear Pro	00-03	536ATS	28,40€	754ATS	28,40€				
400	YZ400 F	98-98	694SI	28,40€	648SI	28,40€	5123	84,10€	5091	84,10€
400	YZ400 F	99-99	694RSI	39,80€	648SI	28,40€	5123	84,10€	5091	84,10€
426	WR426 F	01-02	694SI	28,40€	604SI	28,40€	5085	164,50€		
426	YZ426 F	00-00	694RSI	39,80€	604RSI	39,80€				
426	YZ426 F	01-01	694RSI	39,80€	604RSI	39,80€	5085	164,50€	5103	96,20€
426	YZ426 F	02-02	694RSI	39,80€	604RSI	39,80€	5085	164,50€	5103	96,20€
450	WR450 F	03-05	694RSI	39,80€	790RSI	39,80€	5085	164,50€	5103	96,20€
450	WR450 F	06-06	694SI	28,40€	790SI	28,40€	5085	164,50€	5103	96,20€
450	WR450 F	07-15	694RSI	39,80€	790RSI	39,80€	5085	164,50€	5103	96,20€
450	WR450 F	16-18	840SI	28,40€	790SI	28,40€	5248	164,50€	5103	96,20€
450	WR450 F	19-20	840SI	28,40€	790SI	28,40€	5248	164,50€		
450	WR450 F	21-22	965SI	28,40€	790SI	28,40€	5248	164,50€		
450	YFM450 FA Kodiak	03-06	536ATS	28,40€	754ATS	28,40€				
450	YFM450 FG Grizzly	07-12	536ATS	28,40€	754ATS	28,40€				
450	YFM450 FWB Kodiak	17-19	536ATS	28,40€	754ATS	28,40€				
450	YFM450 FX Wolverine	06-07	536ATS	28,40€	754ATS	28,40€				
450	YFZ450 /S	04-05	638ATS 611ATS	28,40€ 28,40€	592ATS	28,40€			5023	60,90€
450	YFZ450 /S	06-08	638ATS 611ATS	28,40€ 28,40€	709ATS	28,40€			5023	60,90€
450	YFZ450 R	09-18	638ATS 611ATS	28,40€ 28,40€	709ATS	28,40€			5023	60,90€
450	YZ450 F	03-07	694RSI	39,80€	790RSI	39,80€	5085	164,50€	5103	96,20€
450	YZ450 F	08-12	840RSI	39,80€	790RSI	39,80€	5085	164,50€	5103	96,20€
450	YZ450 F	13-13	840SI	28,40€	790SI	28,40€	5085	164,50€	5103	96,20€
450	YZ450 F	14-15	840RSI	39,80€	790RSI	39,80€	5085	164,50€	5103	96,20€
450	YZ450 F	16-16	840RSI	39,80€	790RSI	39,80€	5248	164,50€	5103	96,20€
450	YZ450 F	17-18	840RSI	39,80€	790RSI	39,80€	5248	164,50€	5103	96,20€
450	YZ450 F	19-19	840RSI	39,80€	790RSI	39,80€	5248	164,50€		
450	YZ450 F	20-22	965RSI	39,80€	790RSI	39,80€	5248	164,50€		
600	YFM600 FWA	98-01	592ATS	28,40€	02066	48,50€				
660	YFM660 Grizzly	02-08	592ATS	28,40€	799ATS	28,40€				
660	YFM660 Raptor	01-05	592ATS	28,40€	592ATS	28,40€				
700	YFM700 F Grizzly	07-18	850ATS 849ATS	28,40€ 28,40€	852ATS 851ATS	28,40€ 28,40€				
700	YFM700 R Raptor	06-18	611ATS 638ATS	28,40€ 28,40€	816ATS	28,40€			5023	60,90€

BRAKING

		BRAKING		BRAKING		BRAKING		BRAKING		BRAKING		
		Années	DISQUE AV WAVE	€ T.T.C.	DISQUE AR WAVE	€ T.T.C.	DISQUE AV ROND	€ T.T.C.	DISQUE AR ROND	€ T.T.C.	DISQUE 270mm OVERSIZE	€ T.T.C.
YAMAHA												
350	YFM350 Bruin	04-05										
350	YFM350 Bruin	06-06										
350	YFM350 FX Wolverine	95-04										
350	YFM350 Grizzly	07-18										
350	YFM350 R Raptor	04-16	YA30FID	112,40€	YA43RID	112,00€						
350	YFM350 X Warrior	87-88	YA30FID	112,40€								
350	YFM350 X Warrior	89-94	YA30FID	112,40€								
350	YFM350 X Warrior	95-04	YA30FID	112,40€								
350	YFZ350 Banshee	90-05	YA30FID	112,40€	YA30RID	104,46€						
400	WR400 F	98-98			YA01RID	113,30€			YA01RI	99,70€	WL4010 POW04	195,90€ 65,80€
400	WR400 F	99-01			YA01RID	113,30€			YA01RI	99,70€	WL4010 POW04	195,90€ 65,80€
400	YFM400 FA Kodiak	00-05										
400	YFM400 FP Big Bear	03-05										
400	YFM400 FW Big Bear Pro	00-03										
400	YZ400 F	98-98			YA01RID	113,30€			YA01RI	99,70€	WL4010 POW04	195,90€ 65,80€
400	YZ400 F	99-99			YA01RID	113,30€			YA01RI	99,70€	WL4010 POW04	195,90€ 65,80€
426	WR426 F	01-02	SZ01FID	142,30€	YA10RID	141,70€	SZ01FI	130,80€	YA10RI	107,88€	WL4010 POW04	195,90€ 65,80€
426	YZ426 F	00-00			YA10RID	141,70€			YA10RI	107,88€	WL4010 POW04	195,90€ 65,80€
426	YZ426 F	01-01	SZ01FID	142,30€	YA10RID	141,70€	SZ01FI	130,80€	YA10RI	107,88€	WL4010 POW04	195,90€ 65,80€
426	YZ426 F	02-02	SZ01FID	142,30€	YA52RID	135,40€	SZ01FI	130,80€			WL4010 POW04	195,90€ 65,80€
450	WR450 F	03-05	SZ01FID	142,30€	YA52RID	135,40€	SZ01FI	130,80€			WL4010 POW04	195,90€ 65,80€
450	WR450 F	06-06	SZ01FID	142,30€	YA52RID	135,40€	SZ01FI	130,80€			WL4010 POW04	195,90€ 65,80€
450	WR450 F	07-15	SZ01FID	142,30€	YA52RID	135,40€	SZ01FI	130,80€			WL4010 POW04	195,90€ 65,80€
450	WR450 F	16-18	WL4010	195,90€	YA52RID	135,40€						
450	WR450 F	19-20	WL4010	195,90€	WF4512	130,80€						
450	WR450 F	21-22	WL4010	195,90€	WF4512	130,80€						
450	YFM450 FA Kodiak	03-06										
450	YFM450 FG Grizzly	07-12										
450	YFM450 FWB Kodiak	17-19										
450	YFM450 FX Wolverine	06-07										
450	YFZ450 /S	04-05	YA30FID	112,40€	YA43RID	112,00€						
450	YFZ450 /S	06-08	YA30FID	112,40€	YA51RID	112,00€						
450	YFZ450 R	09-18	YA30FID	112,40€	YA51RID	112,00€						
450	YZ450 F	03-07	SZ01FID	142,30€	YA52RID	135,40€	SZ01FI	130,80€			WL4010 POW04	195,90€ 65,80€
450	YZ450 F	08-12	SZ01FID	142,30€	YA52RID	135,40€	SZ01FI	130,80€			WL4010 POW78	195,90€ 65,81€
450	YZ450 F	13-13	SZ01FID	142,30€	YA52RID	135,40€	SZ01FI	130,80€			WL4010 POW78	195,90€ 65,81€
450	YZ450 F	14-15	SZ01FID	142,30€	YA52RID	135,40€	SZ01FI	130,80€			WL4010 POW78	195,90€ 65,81€
450	YZ450 F	16-16	WL4010	195,90€	YA52RID	135,40€	SZ01FI	130,80€				
450	YZ450 F	17-18	WL4010	195,90€	YA52RID	135,40€						
450	YZ450 F	19-19	WL4010	195,90€	WF4512	130,80€						
450	YZ450 F	20-22	WL4010	195,90€	WF4512	130,80€						
600	YFM600 FWA	98-01										
660	YFM660 Grizzly	02-08										
660	YFM660 Raptor	01-05	YA30FID	112,40€	YA30RID	104,46€						
700	YFM700 F Grizzly	07-18										
700	YFM700 R Raptor	06-18	YA30FID	112,40€	YA51RID	112,00€						

PLAQUETTES & DISQUES



Spécialiste depuis 1964

SBS a été la première entreprise à fabriquer des plaquettes de frein pour le marché de la deuxième monte pour motos. Depuis 50 ans, SBS développe de nouveaux produits avec, toujours à l'esprit : la performance, la sécurité, le confort et la durée de vie.

Leader du marché mondial

Développée et fabriquée au Danemark, SBS est la marque de plaquettes la plus vendue en Europe.



Fournisseur de l'OEM

Gage de haute qualité et de sérieux, de nombreuses motos, parmi les plus vendues du marché, sont équipées des plaquettes de frein fabriquées par SBS en équipement d'origine.

Carbon Silver - CS

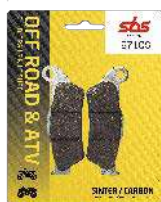

Recommandées pour la pratique quotidienne du motocross et les entraînements



Sinter - SI

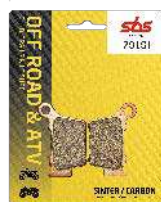

Assurent performance et longévité en conditions extrêmes, sans oublier un freinage de haut niveau

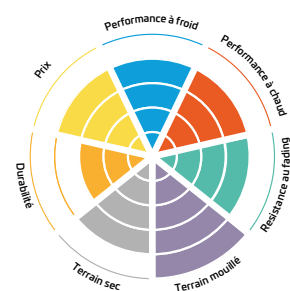

Racing Sinter - RSI



Recommandées pour la compétition. Performance, endurance et freinage d'exception.

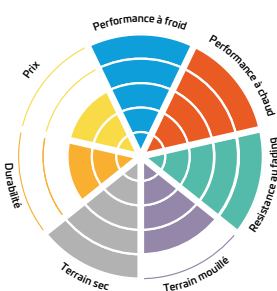



La performance sous contrôle

BRAKING est né en 1990 et a acquis une réputation internationale grâce à l'invention du disque WAVE®. Depuis ses débuts, Braking a été fortement engagé dans le monde de la course, aidant ses équipes à être plus compétitives en fournissant des solutions technologiquement avancées d'année en année.

La recherche d'améliorations permet le développement de produits visant l'optimisation des systèmes de freinage des véhicules pour une plus grande sécurité et un meilleur contrôle.

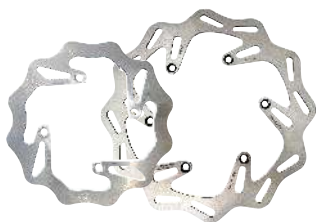

Wave origine

Disques avant et arrière traditionnels WAVE fixes, identiques aux modèles d'origine.



Disque rond

Avant et arrière en remplacement de l'origine



W-FLO Avant

Disque WAVE flottant 270 mm
Patte de déport à commander

Gamme OVERSIZE

- Freinage plus puissant.
- Excellent feeling.
- Flottant avec rivets de centrage.
- Gros Diamètre : 270mm.
- Gain de poids

Le kit oversize permet de monter un disque de frein avant de plus grand diamètre afin de gagner en puissance, en mordant, en endurance et en feeling.

Attention : pour certaines motos, vous devez mettre une patte de déport pour installer un disque en 270mm.

Consulter notre guide d'applications afin de trouver le kit pour votre moto.





Technologie Japonaise

*Protection intégrale de votre
moteur, par MIW filters.*

Développés au Japon et destinés à la monte d'origine comme à l'after market, les filtres MIW utilisent la technologie de filtration « Multi Stage Filtration » pour assurer la protection du moteur contre les impuretés et les débris.

Qualité et choix

La marque MIW (également connue sous le nom de Meiwa Company Ltd.) est l'une des marques leaders dans la technologie des filtres depuis plus de 40 ans. Elle produit l'une des lignes de filtres à huile et à air les plus populaires sur le marché.

Aujourd'hui, MIW est plus fort que jamais, avec une nouvelle gamme de filtres à air et à huile pour tous les modèles de motos et de scooters les plus populaires.

www.miwfilters.com/fr



FILTRATION

FILTRES À AIR /
FILTRES À HUILE /



GUIDE D'APPLICATION

DT1
MIW



376

406

410

FILTRATION



Cyl	Modèle	Année	FILTRE À HUILE	€ T.T.C.	FILTRE À AIR MOUSSE	€ T.T.C.	FILTRE À HUILE	€ T.T.C.	DOUBLE MOUSSE	€ T.T.C.	TRIPLE MOUSSE	€ T.T.C.
APRILIA												
350	Tuareg	86-89	268151	8,10€			KN151	11,75€				
450	RXV450	06-14	268563	10,15€								
450	SXV450	06-14	268563	10,15€								
550	RXV550	06-14	268563	10,15€								
550	SXV550	06-14	268563	10,15€								
ARCTIC CAT												
250	Cat 2x4 250	99-11	268132	4,15€			KN132	8,75€				
250	Cat 4x4 250	00-04	268132	4,15€			KN132	8,75€				
250	DVX250	06-08	268132	4,15€			KN132	8,75€				
300	Cat 2x4 300	98-04	268132	4,15€			KN132	8,75€				
300	Cat 4x4 300	05-11	268132	4,15€			KN132	8,75€				
400	Cat 2x4 400	98-08	268138	10,66€			KN138	18,10€				
400	Cat 4x4 400	98-05	268138	10,66€			KN138	18,10€				
400	DVX400	04-08	268139	5,10€			KN139	8,75€				
400	TBX 4x4 400	04-05	268138	10,66€			KN138	18,10€				
500	Cat 2x4 500	98-04	268138	10,66€			KN138	18,10€				
500	Cat 4x4 500	98-10	268138	10,66€			KN138	18,10€				
500	TBX 4x4 500	02-10	268138	10,66€			KN138	18,10€				
500	TRV 4x4 500	03-07	268138	10,66€			KN138	18,10€				
500	TRV 4x4 500	08-11	268621	12,70€								
650	Cat 4x4 650 H1	05-06	268204	10,66€			KN204	18,10€				
650	Cat 4x4 650 H1	07-11	268621	12,70€								
650	Cat 4x4 650 V2 /LE	05-11	268204	10,66€			KN204	18,10€				
650	Prowler XT 650 4x4 H1	06-11	268621	12,70€								
700	Cat 4x4 700	07-11	268621	12,70€								
700	Wild Cat 700	16-17	268621	12,70€								
1000	Wild Cat 1000	16-17	268621	12,70€								
BETA												
125	Alp 125	00-05	268132	4,15€			KN132	8,75€				
125	RR125 Enduro	15-16	268141	6,95€			KN141	11,35€				
125	RR125 Enduro	18-19							267205130	20,20€	267BETA130	22,40€
125	RR125 Enduro	20-22							267205200	20,20€		
125	RR125 Enduro LC 4T	15-22	268141	6,95€			KN141	11,35€				
125	RR125Mortard LC	21-21	268141	6,95€			KN141	11,35€				
125	Zero (Trial)	92-92	268132	4,15€			KN132	8,75€				
200	Alp 200	00-21	268132	4,15€			KN132	8,75€				
200	RR200 Enduro	19-19							267205130	20,20€		
200	RR200 Enduro	20-22							267205200	20,20€		
200	Urban	12-16	268132	4,15€			KN132	8,75€				
250	EVO (Trial) 4T	12-19	268207	5,65€			KN207	10,10€				
250	RR250	05-07	268155 268157	7,15€ 7,15€			KN155 KN157	10,50€ 11,05€		267205070	20,20€	
250	RR250 Enduro	13-15							267205130	20,20€	267BETA130	22,40€
250	RR250 Enduro 2T	13-19							267205130	20,20€	267BETA130	22,40€
250	RR250 Enduro 2T	20-22							267205200	20,20€		
250	XTrainer	18-22							267205130	20,20€	267BETA130	22,40€
300	300RR Enduro	11-12	268631	9,40€								
300	300RR Enduro	13-17	268631	9,40€					267205130	20,20€	267BETA130	22,40€
300	300RR Enduro 2T	13-19							267205130	20,20€	267BETA130	22,40€
300	300RR Enduro 2T	20-22							267205200	20,20€		
300	EVO (Trial) 4T	12-22	268207	5,65€			KN207	10,10€				
300	XTrainer	18-22							267205130	20,20€	267BETA130	22,40€
350	350RR Enduro	12-12	268631	9,40€					267205070	20,20€		
350	350RR Enduro	13-19	268631	9,40€					267205130	20,20€	267BETA130	22,40€
350	350RR Enduro	20-22	268631	9,40€					267205200	20,20€		
350	Alp 4.0 350	04-05	268136	6,10€								
350	Motard 4.0 350	04-05	268136	6,10€								
390	RR390 Enduro	14-19	268631	9,40€					267205130	20,20€	267BETA130	22,40€
390	RR390 Enduro	20-22	268631	9,40€					267205200	20,20€		
400	RR400 Enduro	05-09	268155 268157	7,15€ 7,15€			KN155 KN157	10,50€ 11,05€		267205070	20,20€	
400	RR400 Enduro	10-12	268631	9,40€					267205070	20,20€		
400	RR400 Enduro	13-15	268631	9,40€					267205130	20,20€	267BETA130	22,40€
430	RR430 Enduro	13-19	268631	9,40€					267205130	20,20€	267BETA130	22,40€
430	RR430 Enduro	20-22	268631	9,40€					267205200	20,20€		
450	RR450 Enduro	05-09	268155 268157	7,15€ 7,15€			KN155 KN157	10,50€ 11,05€		267205070	20,20€	



Cyl	Modèle	Année	EVO	€ T.T.C.	COUVERCLE DE NETTOYAGE	€ T.T.C.	CAGE ALU STANDARD	€ T.T.C.	CAGE ALU EVO	€ T.T.C.
APRILIA										
350	Tuareg	86-89								
450	RXV450	06-14								
450	SXV450	06-14								
550	RXV550	06-14								
550	SXV550	06-14								
ARCTIC CAT										
250	Cat 2x4 250	99-11								
250	Cat 4x4 250	00-04								
250	DVX250	06-08								
300	Cat 2x4 300	98-04								
300	Cat 4x4 300	05-11								
400	Cat 2x4 400	98-08								
400	Cat 4x4 400	98-05								
400	DVX400	04-08								
400	TBX 4x4 400	04-05								
500	Cat 2x4 500	98-04								
500	Cat 4x4 500	98-10								
500	TBX 4x4 500	02-10								
500	TRV 4x4 500	03-07								
500	TRV 4x4 500	08-11								
650	Cat 4x4 650 H1	05-06								
650	Cat 4x4 650 H1	07-11								
650	Cat 4x4 650 V2 /LE	05-11								
650	Prowler XT 650 4x4 H1	06-11								
700	Cat 4x4 700	07-11								
700	Wild Cat 700	16-17								
1000	Wild Cat 1000	16-17								
BETA										
125	Alp 125	00-05								
125	RR125 Enduro	15-16								
125	RR125 Enduro	18-19								
125	RR125 Enduro	20-22								
125	RR125 Enduro LC 4T	15-22								
125	RR125 Mortard LC	21-21								
125	Zero (Trial)	92-92								
200	Alp 200	00-21								
200	RR200 Enduro	19-19								
200	RR200 Enduro	20-22								
200	Urban	12-16								
250	EVO (Trial) 4T	12-19								
250	RR250	05-07								
250	RR250 Enduro	13-15					267AIRCBETA13	-		
250	RR250 Enduro 2T	13-19					267AIRCBETA13	-		
250	RR250 Enduro 2T	20-22								
250	XTrainer	18-22					267AIRCBETA13	-		
300	300RR Enduro	11-12								
300	300RR Enduro	13-17					267AIRCBETA13	-		
300	300RR Enduro 2T	13-19					267AIRCBETA13	-		
300	300RR Enduro 2T	20-22								
300	EVO (Trial) 4T	12-22								
300	XTrainer	18-22					267AIRCBETA13	-		
350	350RR Enduro	12-12								
350	350RR Enduro	13-19					267AIRCBETA13	-		
350	350RR Enduro	20-22								
350	Alp 4.0 350	04-05								
350	Motard 4.0 350	04-05								
390	RR390 Enduro	14-19					267AIRCBETA13	-		
390	RR390 Enduro	20-22								
400	RR400 Enduro	05-09								
400	RR400 Enduro	10-12								
400	RR400 Enduro	13-15					267AIRCBETA13	-		
430	RR430 Enduro	13-19					267AIRCBETA13	-		
430	RR430 Enduro	20-22								
450	RR450 Enduro	05-09								

FILTRATION



Cyl	Modèle	Année	FILTRE À HUILE	€ T.T.C.	FILTRE À AIR MOUSSE	€ T.T.C.	FILTRE À HUILE	€ T.T.C.	DOUBLE MOUSSE	€ T.T.C.	TRIPLE MOUSSE	€ T.T.C.
BETA												
450	RR450 Enduro	10-12	268631	9,40€					267205070	20,20€		
450	RR450 Enduro	13-15	268631	9,40€					267205130	20,20€	267BETA130	22,40€
480	RR480 Enduro	13-19	268631	9,40€					267205130	20,20€	267BETA130	22,40€
480	RR480 Enduro	20-22	268631	9,40€					267205200	20,20€		
498	RR498 Enduro	12-12	268631	9,40€					267205070	20,20€		
498	RR498 Enduro	13-15	268631	9,40€					267205130	20,20€	267BETA130	22,40€
520	RR520 Enduro	13-15	268631	9,40€					267205130	20,20€	267BETA130	22,40€
525	RR525 Enduro	05-09	268155 268157	7,15€ 7,15€			KN155 KN157	10,50€ 11,05€	267205070	20,20€		
525	RR525 Enduro	10-12	268631	9,40€					267205070	20,20€		
BMW												
450	G450 X	08-11	268611	7,60€			KN611	11,05€				
BOMBARDIER												
200	Rally 200	03-06	268559	5,90€								
330	Outlander 330	04-06	268152	10,36€			KN152	12,00€				
400	Outlander 400 /Max	03-06	268152	10,36€			KN152	12,00€				
500	Quest 500	02-06	268556	9,80€								
500	Traxter 500	99-06	268557	11,60€								
500	Traxter 500 Max	03-05	268557	11,60€								
650	DS650 Desert Storm	00-00	268151	8,10€			KN151	11,75€				
650	DS650 Desert Storm	01-06	268152	10,36€			KN152	12,00€				
650	Quest 650	02-06	268556	9,80€								
650	Quest 650 Max	03-06	268556	9,80€								
650	Traxter 650 Max	03-05	268556	9,80€								
800	Outlander 800	06-06	268152	10,36€			KN152	12,00€				
800	Outlander 800 XT	06-06	268152	10,36€			KN152	12,00€				
FANTIC												
125	XE 125	21-22			267570	12,50€			267180500	20,20€		
125	XX 125	21-22			267570	12,50€			267180500	20,20€		
250	XEF 250	21-22	268140	6,95€			KN140	10,10€				
250	XX 250	22-22			267570	12,50€			267180500	20,20€		
250	XXF 250	22-22	268140	6,95€			KN140	10,10€				
450	XEF 450	22-22	268140	6,95€			KN140	10,10€				
450	XXF 450	22-22	268140	6,95€			KN140	10,10€				
GAS GAS												
50	MC50	21-22			267533	7,70€			267150010	6,60€		
65	MC65	21-22			267536	12,50€			267150040	20,20€	267KTM050	20,20€
85	MC85 14/17 pouces	22-22							267150180	20,20€		
85	MC85 16/19 pouces	21-22							267150180	20,20€		
125	EC125	97-06							267190440	20,20€		
125	EC125	07-14							267190470	20,20€		
125	MC125	01-13							267190440	20,20€		
125	MC125	21-22			267539	12,50€			267150160	20,20€		
200	EC200	99-06							267190440	20,20€		
200	EC200	07-20							267190470	20,20€		
200	EC200 Hobby	99-06							267190440	20,20€		
200	MC200	04-06							267190440	20,20€		
200	MC200 Hobby	02-06							267190440	20,20€		
250	EC250	96-06							267190440	20,20€		
250	EC250	07-17							267190470	20,20€		
250	EC250	18-20							267190180	20,20€		
250	EC250	21-22			267539	12,50€			267150160	20,20€		
250	EC250F	21-22	268652	7,36€	267539	12,50€	KN652	11,35€	267150160	20,20€		
250	MC250	97-06							267190440	20,20€		
250	MC250	22-22			267539	12,50€			267150160	20,20€		
250	MC250F	21-22	268652	7,36€	267539	12,50€	KN652	11,35€	267150160	20,20€		
300	EC300	99-06							267190440	20,20€		
300	EC300	07-17							267190470	20,20€		
300	EC300	18-20							267190180	20,20€		
300	EC300	21-22			267539	12,50€			267150160	20,20€		
300	EC300 Ranger	19-20							267190180	20,20€		
350	EC350F	21-22	268652	7,36€	267539	12,50€	KN652	11,35€	267150160	20,20€		
350	MC350F	22-22	268652	7,36€	267539	12,50€	KN652	11,35€	267150160	20,20€		
400	EC400 FSE	02-09	268112	4,40€			KN112	8,75€				
450	EC450 FSE	02-02	268112	4,40€			KN112	8,75€				
450	EC450 FSE	03-06	268112	4,40€			KN112	8,75€	267190440	20,20€		



Cyl	Modèle	Année	EVO	€ T.T.C.	COUVERCLE DE NETTOYAGE	€ T.T.C.	CAGE ALU STANDARD	€ T.T.C.	CAGE ALU EVO	€ T.T.C.
BETA										
450	RR450 Enduro	10-12								
450	RR450 Enduro	13-15					267AIRCBETA13	-		
480	RR480 Enduro	13-19					267AIRCBETA13	-		
480	RR480 Enduro	20-22								
498	RR498 Enduro	12-12								
498	RR498 Enduro	13-15					267AIRCBETA13	-		
520	RR520 Enduro	13-15					267AIRCBETA13	-		
525	RR525 Enduro	05-09								
525	RR525 Enduro	10-12								
BMW										
450	G450 X	08-11								
BOMBARDIER										
200	Rally 200	03-06								
330	Outlander 330	04-06								
400	Outlander 400 /Max	03-06								
500	Quest 500	02-06								
500	Traxter 500	99-06								
500	Traxter 500 Max	03-05								
650	DS650 Desert Storm	00-00								
650	DS650 Desert Storm	01-06								
650	Quest 650	02-06								
650	Quest 650 Max	03-06								
650	Traxter 650 Max	03-05								
800	Outlander 800	06-06								
800	Outlander 800 XT	06-06								
FANTIC										
125	XE 125	21-22	267E180500	22,40€	267YZF9603BL	25,00€			26780860	126,00€
125	XX 125	21-22	267E180500	22,40€	267YZF9603BL	25,00€			26780860	126,00€
250	XE 250	21-22	267E180190	20,20€			26780970 ¹	233,40€	26780960	91,90€
250	XX 250	22-22	267E180500	22,40€	267YZF9603BL	25,00€			26780860	126,00€
250	XXF 250	22-22	267E180190	20,20€			26780970 ¹	233,40€	26780960	91,90€
450	XE 450	22-22	267E180190	20,20€			26780970 ¹	233,40€	26780960	91,90€
450	XXF 450	22-22	267E180190	20,20€			26780970 ¹	233,40€	26780960	91,90€
GAS GAS										
50	MC50	21-22								
65	MC65	21-22								
85	MC85 14/17 pouces	22-22			267KTM0018BL	25,00€	267AIRCKTM18	130,80€		
85	MC85 16/19 pouces	21-22			267KTM0018BL	25,00€	267AIRCKTM18	130,80€		
125	EC125	97-06								
125	EC125	07-14								
125	MC125	01-13								
125	MC125	21-22	267E150160	22,40€	267KTM0016BL	25,00€	267AIRCKTM16	130,80€		
200	EC200	99-06								
200	EC200	07-20								
200	EC200 Hobby	99-06								
200	MC200	04-06								
200	MC200 Hobby	02-06								
250	EC250	96-06								
250	EC250	07-17								
250	EC250	18-20								
250	EC250	21-22	267E150160	22,40€	267KTM0016BL	25,00€	267AIRCKTM16	130,80€		
250	EC250F	21-22	267E150160	22,40€	267KTM0016BL	25,00€	267AIRCKTM16	130,80€		
250	MC250	97-06								
250	MC250	22-22	267E150160	22,40€	267KTM0016BL	25,00€	267AIRCKTM16	130,80€		
250	MC250F	21-22	267E150160	22,40€	267KTM0016BL	25,00€	267AIRCKTM16	130,80€		
300	EC300	99-06								
300	EC300	07-17								
300	EC300	18-20								
300	EC300	21-22	267E150160	22,40€	267KTM0016BL	25,00€	267AIRCKTM16	130,80€		
300	EC300 Ranger	19-20								
350	EC350F	21-22	267E150160	22,40€	267KTM0016BL	25,00€	267AIRCKTM16	130,80€		
350	MC350F	22-22	267E150160	22,40€	267KTM0016BL	25,00€	267AIRCKTM16	130,80€		
400	EC400 FSE	02-09								
450	EC450 FSE	02-02								
450	EC450 FSE	03-06								

FILTRATION



Cyl	Modèle	Année	FILTRE À HUILE	€ T.T.C.	FILTRE À AIR MOUSSE	€ T.T.C.	FILTRE À HUILE	€ T.T.C.	DOUBLE MOUSSE	€ T.T.C.	TRIPLE MOUSSE	€ T.T.C.
GAS GAS												
450	EC450 FSR	07-14	268112	4,40€			KN112	8,75€	267190440	20,20€		
450	MC450F	21-22	268652	7,36€	267539	12,50€	KN652	11,35€	267150160	20,20€		
450	Pampera 450	08-13	268112	4,40€			KN112	8,75€	267190440	20,20€		
450	Wild HP 450	03-05	268112	4,40€			KN112	8,75€				
515	EC515 FSR	08-09							267190470	20,20€		
GOES												
50	G50 S	09-14	268682	10,66€								
300	G300 S	14-14	268682	10,66€								
400	G400i S	14-14	268682	10,66€								
450	450 X	09-11	268682	10,66€								
450	G450 R SM	14-14	268682	10,66€								
520	G520 F /MAX	12-14	268682	10,66€								
525	G525	12-14	268682	10,66€								
625	G625i /MAX	10-14	268682	10,66€								
725	G725i S	14-14	268682	10,66€								
HM												
230	CRF230 Easy	04-06	268112	4,40€			KN112	8,75€				
250	CRE250 F Enduro	04-06	268116	5,20€			KN116	10,00€				
450	CRE450 F Enduro	02-05	268116	5,20€			KN116	10,00€				
450	CRE450 X Enduro	04-13	268116	5,20€			KN116	10,00€				
HONDA												
50	CRF50	04-22							267120010	6,60€		
50	XR50	00-03							267120010	6,60€		
70	CRF70	04-13							267120010	6,60€		
70	XR70 R	95-03							267120010	6,60€		
80	CR80 R	86-86			267502	12,50€			267120020	20,20€		
80	CR80 R (17"/14")	87-02			267502	12,50€			267120020	20,20€		
80	CR80 R (17"/14") >428<	96-02			267502	12,50€			267120020	20,20€		
80	CR80 R (19"/16")	96-02			267502	12,50€			267120020	20,20€		
80	CR80 R (19"/16") >420<	96-02			267502	12,50€			267120020	20,20€		
80	CR80 R (19"/16")	03-09			267502	12,50€			267120020	20,20€		
85	CR85 (17"/14")	03-08			267502	12,50€			267120020	20,20€		
85	CR85 (17"/14") >428<	03-08			267502	12,50€			267120020	20,20€		
85	CR85-B (19"/16")	03-08			267502	12,50€			267120020	20,20€		
85	CR85-B (19"/16") >428<	03-08			267502	12,50€			267120020	20,20€		
125	CR125 R	82-85							267120400	20,20€		
125	CR125 R	89-01							267120430	20,20€		
125	CR125 R	02-07			267505	12,50€			267120440	20,20€		
150	CRF150 F	03-14	268116	5,20€			KN116	10,00€	267120480	20,20€		
150	CRF150 R	07-15	268116	5,20€			KN116	10,00€	267120480	20,20€		
230	CRF230 F	03-14	268116	5,20€			KN116	10,00€	267120480	20,20€		
250	CR250 R	88-01							267120430	20,20€		
250	CR250 R	02-08			267505	12,50€			267120440	20,20€		
250	CRF250 R	04-09	268116	5,20€	267507	12,50€	KN116	10,00€	267120460	20,20€		
250	CRF250 R	10-13	268116	5,20€	267510	12,50€	KN116	10,00€	267120490	20,20€		
250	CRF250 R	14-17	268116	5,20€	267511	12,50€	KN116	10,00€	267120500	20,20€		
250	CRF250 R	18-21	268116	5,20€	267512	12,50€	KN116	10,00€	267120170	20,20€		
250	CRF250 R	22-22	268116	5,20€			KN116	10,00€	267120210	19,00€		
250	CRF250 RX	20-21	268116	5,20€	267512	12,50€	KN116	10,00€	267120170	20,20€		
250	CRF250 RX	22-22	268116	5,20€			KN116	10,00€	267120210	19,00€		
250	CRF250 X	04-15	268116	5,20€	267507	12,50€	KN116	10,00€	267120470	20,20€		
250	TRX250 R	90-92	268112 268113	4,40€ 4,40€			KN112 KN113	8,75€ 8,75€				
250	TRX250 R /Fourtrax [US]	86-89	268112 268113	4,40€ 4,40€			KN112 KN113	8,75€ 8,75€				
250	TRX250 Sportrax EX	01-08	268112 268113	4,40€ 4,40€			KN112 KN113	8,75€ 8,75€				
250	TRX250 X [US]	87-92	268112 268113	4,40€ 4,40€			KN112 KN113	8,75€ 8,75€				
300	CRF300 RX	21-21	268116	5,20€	267512	12,50€	KN116	10,00€	267120170	20,20€		
300	CRF300 RX	22-22	268116	5,20€			KN116	10,00€	267120210	19,00€		
300	TRX300 Sportrax EX	00-09	268112	4,40€			KN112 KN113	8,75€ 8,75€				
350	TRX350 FE /TE /FM	00-06	268113	4,40€			KN113	8,75€				
400	CRF400 RX	21-22	268116	5,20€			KN116	10,00€	267120210	19,00€		
400	TRX Foreman	95-03	268113	4,40€			KN113	8,75€				
400	TRX400 Fourtrax	99-03	268113	4,40€			KN113	8,75€				



Cyl	Modèle	Année	EVO	€ T.T.C.	COUVERCLE DE NETTOYAGE	€ T.T.C.	CAGE ALU STANDARD	€ T.T.C.	CAGE ALU EVO	€ T.T.C.
GAS GAS										
450	EC450 FSR	07-14								
450	MC450F	21-22	267E150160	22,40€	267KTM0016BL	25,00€	267AIRCKTM16	130,80€		
450	Pampera 450	08-13								
450	Wild HP 450	03-05								
515	EC515 FSR	08-09								
GOES										
50	G50 S	09-14								
300	G300 S	14-14								
400	G400i S	14-14								
450	450 X	09-11								
450	G450 R SM	14-14								
520	G520 F /MAX	12-14								
525	G525	12-14								
625	G625i /MAX	10-14								
725	G725i S	14-14								
HM										
230	CRF230 Easy	04-06								
250	CRE250 F Enduro	04-06								
450	CRE450 F Enduro	02-05								
450	CRE450 X Enduro	04-13								
HONDA										
50	CRF50	04-22								
50	XR50	00-03								
70	CRF70	04-13								
70	XR70 R	95-03								
80	CR80 R	86-86								
80	CR80 R (17"/14")	87-02								
80	CR80 R (17"/14") >428<	96-02								
80	CR80 R (19"/16")	96-02								
80	CR80 R (19"/16") >420<	96-02								
80	CR80 R (19"/16")	03-09								
85	CR85 (17"/14")	03-08								
85	CR85 (17"/14") >428<	03-08								
85	CR85-B (19"/16")	03-08								
85	CR85-B (19"/16") >428<	03-08								
125	CR125 R	82-85								
125	CR125 R	89-01								
125	CR125 R	02-07								
150	CRF150 F	03-14								
150	CRF150 R	07-15								
230	CRF230 F	03-14								
250	CR250 R	88-01								
250	CR250 R	02-08								
250	CRF250 R	04-09			267KXF0011BL	25,00€				
250	CRF250 R	10-13	267E120490	22,40€	267CRF0009BL	25,00€	26780870	114,00€	26780870	114,00€
250	CRF250 R	14-17	267E120500	22,40€	267CRF0013BL	25,00€	26780875	114,00€	26780875	114,00€
250	CRF250 R	18-21	267E120170	22,40€	267CRF0017BL	25,00€	267AIRCHON03	130,80€	267AIRCHON03	130,80€
250	CRF250 R	22-22			267CRF0021BL	25,00€				
250	CRF250 RX	20-21	267E120170	22,40€	267CRF0017BL	25,00€	267AIRCHON03	130,80€	267AIRCHON03	130,80€
250	CRF250 RX	22-22			267CRF0021BL	25,00€				
250	CRF250 X	04-15			267KXF0011BL	25,00€				
250	TRX250 R	90-92								
250	TRX250 R /Fourtrax [US]	86-89								
250	TRX250 Sportrax EX	01-08								
250	TRX250 X [US]	87-92								
300	CRF300 RX	21-21	267E120170	22,40€	267CRF0017BL	25,00€	267AIRCHON03	130,80€	267AIRCHON03	130,80€
300	CRF300 RX	22-22								
300	TRX300 Sportrax EX	00-09								
350	TRX350 FE /TE /FM	00-06								
400	CRF400 RX	21-22			267CRF0021BL	25,00€				
400	TRX Foreman	95-03								
400	TRX400 Fourtrax	99-03								

FILTRATION



Cyl	Modèle	Année	FILTRE À HUILE	€ T.T.C.	FILTRE À AIR MOUSSE	€ T.T.C.	FILTRE À HUILE	€ T.T.C.	DOUBLE MOUSSE	€ T.T.C.	TRIPLE MOUSSE	€ T.T.C.
HONDA												
400	TRX400 Fourtrax	04-09	268111	5,75€								
400	TRX400 Sportrax	99-09	268113	4,40€			KN113	8,75€				
400	XR400 R	96-06	268112	4,40€	267513	12,50€	KN112	8,75€	267220020	20,20€		
400	XR400 Supermotard	96-06	268112	4,40€	267513	12,50€	KN112	8,75€	267220020	20,20€		
420	TRX420 Fourtrax	10-10	268114	8,10€					267220020	20,20€		
420	TRX420 Fourtrax	11-12	268114	8,10€								
450	CRF450 R	02-02	268116	5,20€			KN116	10,00€	267120450	20,20€		
450	CRF450 R	03-08	268116	5,20€	267507	12,50€	KN116	10,00€	267120460	20,20€		
450	CRF450 R	09-12	268116	5,20€	267510	12,50€	KN116	10,00€	267120490	20,20€		
450	CRF450 R	13-13	268116	5,20€	267511	12,50€	KN116	10,00€	267120500	20,20€		
450	CRF450 R	14-16	268116	5,20€	267511	12,50€	KN116	10,00€	267120500	20,20€		
450	CRF450 R	17-20	268116	5,20€	267512	12,50€	KN116	10,00€	267120170	20,20€		
450	CRF450 R	21-22	268116	5,20€			KN116	10,00€	267120210	19,00€		
450	CRF450 RX	17-20	268116	5,20€	267512	12,50€	KN116	10,00€	267120170	20,20€		
450	CRF450 RX	21-22	268116	5,20€			KN116	10,00€	267120210	19,00€		
450	CRF450 X	05-16	268116	5,20€	267507	12,50€	KN116	10,00€	267120470	20,20€		
450	CRF450 X	17-20	268116	5,20€	267507	12,50€	KN116	10,00€	267120470	20,20€		
450	TRX450 Foreman	98-04	268113	4,40€			KN113	8,75€				
450	TRX450 R	04-09	268116	5,20€			KN116	10,00€				
450	TRX450 Sportrax	01-09	268116	5,20€			KN116	10,00€				
500	CR500 R	84-85							267120400	20,20€		
500	CR500 R	89-02							267120430	20,20€		
500	TRX500 FA Foretrax, Foreman	00-13	268111	5,75€								
500	XR500 R	81-86	268112	4,40€			KN112	8,75€				
600	XR600 R	85-90	268112	4,40€	267513	12,50€	KN112	8,75€	267220020	20,20€		
600	XR600 R [FR]	91-00	268112	4,40€	267513	12,50€	KN112	8,75€	267220020	20,20€		
650	Fourtrax650	04-04	268111	5,75€								
650	TRX650 FA/FGA Rincon	03-05	268111	5,75€								
650	XR650 L [US]	93-13	268112	4,40€	267513	12,50€	KN112	8,75€	267220020	20,20€		
650	XR650 R	00-07	268112	4,40€			KN112	8,75€				
680	TRX680 FA	06-09	268111	5,75€								
HUSABERG												
125	TE125 2T	11-12							267260100	20,20€		
125	TE125 2T	13-13							267260130	20,20€		
250	FE250 4T	13-14	268652	7,36€			KN652	11,35€				
250	TE250 2T	11-12							267260130	20,20€		
350	FE350 /E	96-99	268155	7,15€			KN155	10,50€				
350	FE350 4T	14-14	268652	7,36€			KN652	11,35€				
350	TE350	14-14	268652	7,36€			KN652	11,35€				
390	FE390 Enduro	10-11	268655	7,60€			KN655	11,35€				
390	FE390 Enduro	12-12	268655	7,60€			KN655	11,35€	267260090	20,20€		
400	FC400	96-99	268155	7,15€			KN155	10,50€				
400	FC400	00-00	268155	7,15€			KN155	10,50€	267260040	20,20€		
400	FE400 /S /E	96-99	268155	7,15€			KN155	10,50€				
400	FE400 /S /E	00-03	268155	7,15€			KN155	10,50€	267260040	20,20€		
450	FC450	04-06	268155	7,15€			KN155	10,50€				
450	FE450	09-11	268655	7,60€			KN655	11,35€	267260090	20,20€		
450	FE450	12-12	268655	7,60€			KN655	11,35€				
450	FE450	12-12	268655	7,60€			KN655	11,35€	267260090	20,20€		
450	FE450	13-14	268655	7,60€			KN655	11,35€				
450	FE450 E	04-08	268155	7,15€			KN155	10,50€	267260040	20,20€		
450	FS450 E /C	03-04	268155	7,15€			KN155	10,50€	267260040	20,20€		
450	FS450 E /C	05-07	268155	7,15€			KN155	10,50€				
450	FS450 E /C	08-08	268155	7,15€			KN155	10,50€	267260040	20,20€		
470	FC470	01-02	268155	7,15€			KN155	10,50€	267260040	20,20€		
501	FC501	94-99	268155	7,15€			KN155	10,50€				
501	FC501	00-00	268155	7,15€			KN155	10,50€	267260040	20,20€		
501	FE501	13-14	268655	7,60€			KN655	11,35€	267260130	20,20€		
501	FE501 /S /E	00-04	268155	7,15€			KN155	10,50€	267260040	20,20€		
501	TE 501	95-99	268155	7,15€			KN155	10,50€				
501	TE 501	00-00	268155	7,15€			KN155	10,50€	267260040	20,20€		
550	FC550	01-04	268155	7,15€			KN155	10,50€	267260040	20,20€		
550	FC550	05-06	268155	7,15€			KN155	10,50€				
550	FE550 /E	04-08	268155	7,15€			KN155	10,50€				
570	FE570 Enduro	09-12	268655	7,60€			KN655	11,35€	267260090	20,20€		



Cyl	Modèle	Année	EVO	€ T.T.C.	COUVERCLE DE NETTOYAGE	€ T.T.C.	CAGE ALU STANDARD	€ T.T.C.	CAGE ALU EVO	€ T.T.C.
HONDA										
400	TRX400 Fourtrax	04-09								
400	TRX400 Sportrax	99-09								
400	XR400 R	96-06								
400	XR400 Supermotard	96-06								
420	TRX420 Fourtrax	10-10								
420	TRX420 Fourtrax	11-12								
450	CRF450 R	02-02								
450	CRF450 R	03-08			267KXF0011BL	25,00€				
450	CRF450 R	09-12	267E120490	22,40€	267CRF0009BL	25,00€	26780870	114,00€	26780870	114,00€
450	CRF450 R	13-13	267E120490	22,40€	267CRF0013BL	25,00€	26780875	114,00€	26780875	114,00€
450	CRF450 R	14-16	267E120500	22,40€	267CRF0013BL	25,00€	26780875	114,00€	26780875	114,00€
450	CRF450 R	17-20	267E120170	22,40€	267CRF0017BL	25,00€	267AIRCHON03	130,80€	267AIRCHON03	130,80€
450	CRF450 R	21-22			267CRF0021BL	25,00€				
450	CRF450 RX	17-20			267CRF0017BL	25,00€				
450	CRF450 RX	21-22			267CRF0021BL	25,00€				
450	CRF450 X	05-16			267KXF0011BL	25,00€				
450	CRF450 X	17-20			267CRF0017BL	25,00€				
450	TRX450 Foreman	98-04								
450	TRX450 R	04-09								
450	TRX450 Sportrax	01-09								
500	CR500 R	84-85								
500	CR500 R	89-02								
500	TRX500 FA Foretrax, Foreman	00-13								
500	XR500 R	81-86								
600	XR600 R	85-90								
600	XR600 R [FR]	91-00								
650	Fourtrax650	04-04								
650	TRX650 FA/FGA Rincon	03-05								
650	XR650 L [US]	93-13								
650	XR650 R	00-07								
680	TRX680 FA	06-09								
HUSABERG										
125	TE125 2T	11-12			267KTM0011BL	25,00€			26780840	91,80€
125	TE125 2T	13-13	267EHUS030	22,40€	267KTM0011BL	25,00€				
250	FE250 4T	13-14								
250	TE250 2T	11-12	267EHUS030	22,40€	267KTM0011BL	25,00€				
350	FE350 /E	96-99								
350	FE350 4T	14-14								
350	TE350	14-14								
390	FE390 Enduro	10-11								
390	FE390 Enduro	12-12								
400	FC400	96-99								
400	FC400	00-00								
400	FE400 /S /E	96-99								
400	FE400 /S /E	00-03								
450	FC450	04-06								
450	FE450	09-11								
450	FE450	12-12								
450	FE450	12-12								
450	FE450	13-14								
450	FE450 E	04-08								
450	FS450 E /C	03-04								
450	FS450 E /C	05-07								
450	FS450 E /C	08-08								
470	FC470	01-02								
501	FC501	94-99								
501	FC501	00-00								
501	FE501	13-14	267EHUS030	22,40€	267KTM0011BL	25,00€				
501	FE501 /S /E	00-04								
501	TE 501	95-99								
501	TE 501	00-00								
550	FC550	01-04								
550	FC550	05-06								
550	FE550 /E	04-08								
570	FE570 Enduro	09-12								

FILTRATION



Cyl	Modèle	Année	FILTRE À HUILE	€ T.T.C.	FILTRE À AIR MOUSSE	€ T.T.C.	FILTRE À HUILE	€ T.T.C.	DOUBLE MOUSSE	€ T.T.C.	TRIPLE MOUSSE	€ T.T.C.
HUSABERG												
600	FC600 (Motocross)	93-99	268155	7,15€			KN155	10,50€				
600	FC600 (Motocross)	00-00	268155	7,15€			KN155	10,50€	267260040	20,20€		
600	FC600 (Supermoto)	93-99	268155	7,15€			KN155	10,50€				
600	FC600 (Supermoto)	00-00	268155	7,15€			KN155	10,50€	267260040	20,20€		
600	FE600 /S /E	00-03	268155	7,15€			KN155	10,50€	267260040	20,20€		
650	FE650 E	01-04	268155	7,15€			KN155	10,50€	267260040	20,20€		
650	FE650 E	05-08	268155	7,15€			KN155	10,50€				
650	FS650 C /E	01-04	268155	7,15€			KN155	10,50€	267260040	20,20€		
650	FS650 C /E	05-08	268155	7,15€			KN155	10,50€				
HUSQVARNA												
50	TC 50	17-22			267533	7,70€			267150010	6,60€		
50	TC 50 Mini	19-22			267533	7,70€			267150010	6,60€		
85	TC 85	14-17							267130140	20,20€	267KTM030*	
85	TC 85	18-22							267130180	20,20€		
125	CR125	92-13							267130420	20,20€		
125	TC125 2T	13-13										
125	TC125 2T	14-15							267130140	20,20€		
125	TC125 2T	16-22			267539	12,50€			267130160	20,20€		
125	TE125 2T	13-16							267130140	20,20€		
125	TX125 2T	17-19			267539	12,50€			267130160	20,20€		
125	WR125	92-13							267130420	20,20€		
150	TE150i	20-22			267539	12,50€			267130160	20,20€		
250	CR250	92-05							267130420	20,20€		
250	FC 250	14-22	268652	7,36€	267539	12,50€	KN652	11,35€	267130160	20,20€		
250	FE250	14-22	268652	7,36€	267539	12,50€	KN652	11,35€	267130160	20,20€		
250	TC250	02-07	268154	7,75€					267130420	20,20€		
250	TC250	08-08	268563	10,15€					267130420	20,20€		
250	TC250	09-13	268116	5,20€			KN116	10,00€	267130420	20,20€		
250	TC250	14-16							267130140	20,20€	267KTM030*	
250	TC250	17-22			267539	12,50€			267130160	20,20€		
250	TE250	02-07	268154	7,75€					267130420	20,20€		
250	TE250	08-09	268563	10,15€					267130420	20,20€		
250	TE250	10-12	268116	5,20€			KN116	10,00€	267130420	20,20€		
250	TE250	13-13	268116	5,20€			KN116	10,00€	267130140	20,20€		
250	TE250	14-16							267130140	20,20€	267KTM030*	
250	TE250	17-17			267539	12,50€			267130160	20,20€		
250	TE250i	18-22			267539	12,50€			267130160	20,20€		
300	TE300	14-16							267130140	20,20€	267KTM030*	
300	TE300	17-17			267539	12,50€			267130160	20,20€		
300	TE300i	18-22			267539	12,50€			267130160	20,20€		
300	WR300	09-12							267130420	20,20€		
310	TE310	09-11	268563	10,15€								
310	TE310	12-13	268563	10,15€					267130420	20,20€		
350	FC 350	14-15	268652	7,36€			KN652	11,35€	267130140	20,20€	267KTM030*	
350	FC 350	16-22	268652	7,36€	267539	12,50€	KN652	11,35€	267130160	20,20€		
350	FE 350	14-22	268652	7,36€	267539	12,50€	KN652	11,35€	267130160	20,20€		
350	TE350	92-95							267130430	20,20€		
360	WR360	92-00							267130420	20,20€		
360	WR360	01-02							267130420	20,20€		
400	TE400	98-02	268154	7,75€								
400	WR-400	87-87	268154	7,75€								
410	TE410	96-01	268154	7,75€					267130500	20,20€		
410	TE410	02-03							267130500	20,20€		
449	TC449	11-13	268611	7,60€	267538	12,50€	KN611	11,05€	267130110	20,20€		
449	TE449	11-13	268611	7,60€	267538	12,50€	KN611	11,05€	267130110	20,20€		
450	FC 450	14-15	268652	7,36€			KN652	11,35€	267130140	20,20€	267KTM030*	
450	FC 450	16-16	268655	7,60€	267539	12,50€	KN655	11,35€	267130160	20,20€		
450	FC 450	17-22	268652	7,36€	267539	12,50€	KN652	11,35€	267130160	20,20€		
450	FE 450	14-15	268652	7,36€			KN652	11,35€	267130140	20,20€	267KTM030*	
450	FE 450	16-16	268655	7,60€			KN655	11,35€	267130140	20,20€	267KTM030*	
450	FE 450	17-22	268652	7,36€	267539	12,50€	KN652	11,35€	267130160	20,20€		
450	FS 450	15-15	268652	7,36€			KN652	11,35€	267130140	20,20€	267KTM030*	
450	FS 450	16-22	268652	7,36€	267539	12,50€	KN652	11,35€	267130160	20,20€		
450	QM450	07-08	268154	7,75€								
450	TC450	02-07	268154	7,75€					267130420	20,20€		
450	TC450	08-12	268563	10,15€					267130420	20,20€		



Cyl	Modèle	Année	EVO	€ T.T.C.	COUVERCLE DE NETTOYAGE	€ T.T.C.	CAGE ALU STANDARD	€ T.T.C.	CAGE ALU EVO	€ T.T.C.
HUSABERG										
600	FC600 (Motocross)	93-99								
600	FC600 (Motocross)	00-00								
600	FC600 (Supermoto)	93-99								
600	FC600 (Supermoto)	00-00								
600	FE600 /S /E	00-03								
650	FE650 E	01-04								
650	FE650 E	05-08								
650	FS650 C /E	01-04								
650	FS650 C /E	05-08								
HUSQVARNA										
50	TC 50	17-22								
50	TC 50 Mini	19-22								
85	TC 85	14-17	267EKTMO30*	22,40€	267HUSQ0011BL	25,00€			26780910*	90,30€
85	TC 85	18-22			267HUSQ0018BL	25,00€	267AIRCHUSQ18	130,80€	267AIRCHUSQ18	130,80€
125	CR125	92-13	267E130420	22,40€					26780880	114,00€
125	TC125 2T	13-13					267AIRCHUSQ02	-	267AIRCHUSQ03	91,80€
125	TC125 2T	14-15			267HUSQ0011BL	25,00€	267AIRCHUSQ02	-	267AIRCHUSQ03	91,80€
125	TC125 2T	16-22			267HUSQ0016BL	25,00€	267AIRCHUSQ16	130,80€	267AIRCHUSQ16	130,80€
125	TE125 2T	13-16			267HUSQ0011BL	25,00€	267AIRCHUSQ02	-	267AIRCHUSQ03	91,80€
125	TX125 2T	17-19	267E130160	22,40€	267HUSQ0016BL	25,00€				
125	WR125	92-13	267E130420	22,40€					26780880	114,00€
150	TE150i	20-22	267E130160	22,40€	267HUSQ0016BL	25,00€	267AIRCHUSQ16	130,80€	267AIRCHUSQ16	130,80€
250	CR250	92-05	267E130420	22,40€					26780880	114,00€
250	FC 250	14-22	267E130160	22,40€	267HUSQ0016BL	25,00€	267AIRCHUSQ16	130,80€	267AIRCHUSQ16	130,80€
250	FE250	14-22	267E130160	22,40€	267HUSQ0016BL	25,00€	267AIRCHUSQ16	130,80€	267AIRCHUSQ16	130,80€
250	TC250	02-07	267E130420	22,40€					26780880	114,00€
250	TC250	08-08	267E130420	22,40€					26780880	114,00€
250	TC250	09-13	267E130420	22,40€					26780880	114,00€
250	TC250	14-16	267EKTMO30*	22,40€	267HUSQ0011BL	25,00€			26780910*	90,30€
250	TC250	17-22	267E130160	22,40€	267HUSQ0016BL	25,00€	267AIRCHUSQ16	130,80€	267AIRCHUSQ16	130,80€
250	TE250	02-07	267E130420	22,40€	267HUSQ0011BL	25,00€			26780880	114,00€
250	TE250	08-09	267E130420	22,40€	267HUSQ0011BL	25,00€			26780880	114,00€
250	TE250	10-12	267E130420	22,40€	267HUSQ0011BL	25,00€			26780880	114,00€
250	TE250	13-13	267E130420	22,40€	267HUSQ0011BL	25,00€			26780880	114,00€
250	TE250	14-16	267EKTMO30*	22,40€	267HUSQ0011BL	25,00€			26780910*	90,30€
250	TE250	17-17	267E130160	22,40€	267HUSQ0016BL	25,00€	267AIRCHUSQ16	130,80€	267AIRCHUSQ16	130,80€
250	TE250i	18-22	267E130160	22,40€	267HUSQ0016BL	25,00€	267AIRCHUSQ16	130,80€	267AIRCHUSQ16	130,80€
300	TE300	14-16	267EKTMO30*	22,40€	267HUSQ0011BL	25,00€			26780910*	90,30€
300	TE300	17-17	267E130160	22,40€	267HUSQ0016BL	25,00€	267AIRCHUSQ16	130,80€	267AIRCHUSQ16	130,80€
300	TE300i	18-22	267E130160	22,40€	267HUSQ0016BL	25,00€	267AIRCHUSQ16	130,80€	267AIRCHUSQ16	130,80€
300	WR300	09-12	267E130420	22,40€					26780880	114,00€
310	TE310	09-11								
310	TE310	12-13	267E130420	22,40€					26780880	114,00€
350	FC 350	14-15	267EKTMO30*	22,40€	267HUSQ0011BL	25,00€			26780910*	90,30€
350	FC 350	16-22	267E130160	22,40€	267HUSQ0016BL	25,00€	267AIRCHUSQ16	130,80€	267AIRCHUSQ16	130,80€
350	FE 350	14-22	267E130160	22,40€	267HUSQ0016BL	25,00€	267AIRCHUSQ16	130,80€	267AIRCHUSQ16	130,80€
350	TE350	92-95								
360	WR360	92-00	267E130420	22,40€					26780880	114,00€
360	WR360	01-02								
400	TE400	98-02								
400	WR-400	87-87								
410	TE410	96-01								
410	TE410	02-03								
449	TC449	11-13								
449	TE449	11-13								
450	FC 450	14-15	267EKTMO30*	22,40€	267HUSQ0011BL	25,00€			26780910*	90,30€
450	FC 450	16-16	267E130160	22,40€	267HUSQ0016BL	25,00€	267AIRCHUSQ16	130,80€	267AIRCHUSQ16	130,80€
450	FC 450	17-22	267E130160	22,40€	267HUSQ0016BL	25,00€	267AIRCHUSQ16	130,80€	267AIRCHUSQ16	130,80€
450	FE 450	14-15	267EKTMO30*	22,40€	267HUSQ0011BL	25,00€			26780910*	90,30€
450	FE 450	16-16	267EKTMO30*	22,40€	267HUSQ0011BL	25,00€			26780910*	90,30€
450	FE 450	17-22	267E130160	22,40€	267HUSQ0016BL	25,00€	267AIRCHUSQ16	130,80€	267AIRCHUSQ16	130,80€
450	FS 450	15-15	267EKTMO30*	22,40€	267HUSQ0011BL	25,00€			26780910*	90,30€
450	FS 450	16-22	267E130160	22,40€	267HUSQ0016BL	25,00€	267AIRCHUSQ16	130,80€	267AIRCHUSQ16	130,80€
450	QM450	07-08								
450	TC450	02-07	267E130420	22,40€					26780880	114,00€
450	TC450	08-12	267E130420	22,40€					26780880	114,00€

FILTRATION



Cyl	Modèle	Année	FILTRE À HUILE	€ T.T.C.	FILTRE À AIR MOUSSE	€ T.T.C.	FILTRE À HUILE	€ T.T.C.	DOUBLE MOUSSE	€ T.T.C.	TRIPLE MOUSSE	€ T.T.C.
HUSQVARNA												
450	TC450	13-13							267130420	20,20€		
450	TE450	02-07	268154	7,75€					267130420	20,20€		
450	TE450	08-13	268563	10,15€					267130420	20,20€		
501	FE 501	14-16	268655	7,60€			KN655	11,35€	267130140	20,20€	267KTM030*	
501	FE 501	17-17	268652	7,36€	267539	12,50€	KN655	11,35€	267130160	20,20€		
501	FE 501	18-22	268652	7,36€	267539	12,50€	KN652	11,35€	267130160	20,20€		
510	SM510 Centennial	06-07	268154	7,75€								
510	SMR510	04-07	268154	7,75€								
510	SMR510	08-12	268563	10,15€								
510	TC510	02-04	268563	10,15€								
510	TC510	05-07	268154	7,75€								
510	TC510	08-12	268563	10,15€								
510	TE510	03-03							267130420	20,20€		
510	TE510	04-07	268154	7,75€					267130420	20,20€		
510	TE510	08-10	268563	10,15€					267130420	20,20€		
510	TE510	11-13	268563	10,15€								
510	TE510 Centennial	04-07	268563	10,15€								
570	TC570	01-02	268154	7,75€					267130420	20,20€		
570	TC570	03-03							267130420	20,20€		
570	TE570	01-03	268154	7,75€								
610	TC610	92-00	268154	7,75€					267130430	20,20€		
610	TC610	01-02	268154	7,75€								
610	TE610	92-00	268154	7,75€					267130430	20,20€		
610	TE610	01-09	268154	7,75€								
610	TE610 E	97-00	268154	7,75€					267130430	20,20€		
610	TE610 E	01-10	268154	7,75€								
610	TE610 i.e.	08-10	268154	7,75€								
630	TE630	10-12	268563	10,15€								
693	Enduro 701	16-22	268651 268155	7,15€ 7,15€								
HYOSUNG												
450	TE450 Sport	07-09	268682	10,66€								
KAWASAKI												
60	KX60	86-99							267140020	20,20€		
65	KX65	00-22							267140040	20,20€		
80	KX80	91-00							267140040	20,20€		
85	KX85	01-22							267140040	20,20€		
110	KLX110	02-21	268112	4,40€			KN112	8,75€				
125	KLX125 C	10-16	268112	4,40€			KN112	8,75€				
125	KLX125 D D-Tracker	10-14	268112	4,40€			KN112	8,75€				
125	KX125	90-01							267140440	20,20€		
125	KX125	02-08			267530	12,50€			267140480	20,20€		
200	KLT 200	83-84	268123	5,30€								
220	KLF220 Bayou	88-03	268123	5,30€								
250	KFX250 Mojave (KSF US)	87-04	268123	5,30€								
250	KLF 250 Bayou 2WD	03-11	268123	5,30€								
250	KLT 250	83-85	268123	5,30€								
250	KLX250 R	93-98	268112	4,40€			KN112	8,75€				
250	KLX250 S /SF	09-17	268112	4,40€			KN112	8,75€				
250	KSF Mojave	87-87	268123	5,30€								
250	KX250	90-01							267140440	20,20€		
250	KX250	02-08			267530	12,50€			267140480	20,20€		
250	KX250 F	04-05	268207	5,65€			KN207	10,10€	267140510	20,20€		
250	KX250 F	06-15	268207	5,65€	267527	12,50€	KN207	10,10€	267140060	20,20€		
250	KX250 F	16-18	268207	5,65€	267528	12,50€	KN207	10,10€	267140160	20,20€		
250	KX250 F - KX	19-20	268207	5,65€	267528	12,50€	KN207	10,10€	267140160	20,20€		
250	KX250 F - KX	21-22	268207	5,65€	267576 VERIFICA	-	KN207	10,10€	267140190	20,20€		
250	KX250X Enduro (KL)	22-22	268207	5,65€	267576 VERIFICA	-	KN207	10,10€	267140190	20,20€		
250	KXF250 F i	11-16	268207	5,65€	267527	12,50€	KN207	10,10€	267140060	20,20€		
300	KEF300 Lakota	95-03	268123	5,30€								
300	KFX300 (KSF US)	04-05	268123	5,30€								
300	KLF300 Bayou	86-07	268123	5,30€								
300	KLX300 R	97-07	268112	4,40€			KN112	8,75€				
300	KVF300 4x4	12-12	268303	10,66€								



Cyl	Modèle	Année	EVO	€ T.T.C.	COUVERCLE DE NETTOYAGE	€ T.T.C.	CAGE ALU STANDARD	€ T.T.C.	CAGE ALU EVO	€ T.T.C.
HUSQVARNA										
450	TC450	13-13	267E130420	22,40€					26780880	114,00€
450	TE450	02-07	267E130420	22,40€					26780880	114,00€
450	TE450	08-13	267E130420	22,40€					26780880	114,00€
501	FE 501	14-16	267EKTMO30*	22,40€	267HUSQ0011BL	25,00€			26780910*	90,30€
501	FE 501	17-17	267E130160	22,40€	267HUSQ0016BL	25,00€	267AIRCHUSQ16	130,80€	267AIRCHUSQ16	130,80€
501	FE 501	18-22	267E130160	22,40€	267HUSQ0016BL	25,00€	267AIRCHUSQ16	130,80€	267AIRCHUSQ16	130,80€
510	SM510 Centennial	06-07								
510	SMR510	04-07								
510	SMR510	08-12								
510	TC510	02-04								
510	TC510	05-07								
510	TC510	08-12								
510	TE510	03-03	267E130420	22,40€					26780880	114,00€
510	TE510	04-07	267E130420	22,40€					26780880	114,00€
510	TE510	08-10	267E130420	22,40€					26780880	114,00€
510	TE510	11-13								
510	TE510 Centennial	04-07								
570	TC570	01-02								
570	TC570	03-03								
570	TE570	01-03								
610	TC610	92-00								
610	TC610	01-02								
610	TE610	92-00								
610	TE610	01-09								
610	TE610 E	97-00								
610	TE610 E	01-10								
610	TE610 i.e.	08-10								
630	TE630	10-12								
693	Enduro 701	16-22								
HYOSUNG										
450	TE450 Sport	07-09								
KAWASAKI										
60	KX60	86-99								
65	KX65	00-22								
80	KX80	91-00								
85	KX85	01-22								
110	KLX110	02-21								
125	KLX125 C	10-16								
125	KLX125 D D-Tracker	10-14								
125	KX125	90-01								
125	KX125	02-08								
200	KLT 200	83-84								
220	KLF220 Bayou	88-03								
250	KFX250 Mojave (KSF [US])	87-04								
250	KLF 250 Bayou 2WD	03-11								
250	KLT 250	83-85								
250	KLX250 R	93-98								
250	KLX250 S /SF	09-17								
250	KSF Mojave	87-87								
250	KX250	90-01								
250	KX250	02-08								
250	KX250 F	04-05								
250	KX250 F	06-15	267E140060	22,40€	267KXF0011BL	25,00€	26780890	164,90€		
250	KX250 F	16-18	267E140160	22,40€	267KXF0016BL	25,00€	267AIRCKAW16	163,20€		
250	KX250 F - KX	19-20	267E140160	22,40€	267KXF0016BL	25,00€	267AIRCKAW16	163,20€		
250	KX250 F - KX	21-22	267E140190	22,50€	267KXF0019BL	25,00€	267AIRCKAW19	-		
250	KX250X Enduro (KL)	22-22	267E140190	22,50€	267KXF0019BL	25,00€	267AIRCKAW19	-		
250	KXF250 F i	11-16	267E140060	22,40€	267KXF0011BL	25,00€	26780890	164,90€		
300	KEF300 Lakota	95-03								
300	KFX300 (KSF [US])	04-05								
300	KLF300 Bayou	86-07								
300	KLX300 R	97-07								
300	KVF300 4x4	12-12								

FILTRATION



Cyl	Modèle	Année	FILTRE À HUILE	€ T.T.C.	FILTRE À AIR MOUSSE	€ T.T.C.	FILTRE À HUILE	€ T.T.C.	DOUBLE MOUSSE	€ T.T.C.	TRIPLE MOUSSE	€ T.T.C.
KAWASAKI												
360	KVF360 Prairie 2x4	03-09	268204	10,66€			KN204	18,10€				
360	KVF360 Prairie 4x4	03-13	268204	10,66€			KN204	18,10€				
400	KFX400 (KSF US)	02-06	268139	5,10€			KN139	8,75€				
400	KLF400 Bayou	93-99	268303	10,66€			KN303	18,10€				
400	KVF400 Prairie	97-98	268204	10,66€			KN204	18,10€				
400	KVF400 Prairie 2x4	99-02	268204	10,66€			KN204	18,10€				
400	KVF400 Prairie 4x4	99-02	268204	10,66€			KN204	18,10€				
450	KFX450 R	07-14	268112	4,40€			KN112	8,75€				
450	KLX450 R	05-07	268112	4,40€			KN112	8,75€				
450	KLX450 R	08-15	268112	4,40€			KN112	8,75€	267140580	20,20€		
450	KX450 F	06-15	268112	4,40€	267527	12,50€	KN112	8,75€	267140060	20,20€		
450	KX450 F	16-18	268207	5,65€	267528	12,50€	KN207	10,10€	267140160	20,20€		
450	KX450 F - KX	19-22	268207	5,65€	267576	-	KN207	10,10€	267140190	20,20€		
450	KX450 X Enduro (KL)	22-22	268207	5,65€	267576	-	KN207	10,10€	267140190	20,20€		
650	KFX650 V-Force	01-02	268204	10,66€			KN204	18,10€				
650	KLX650 C	93-95	268123	5,30€								
650	KLX650 R	93-01	268123	5,30€								
650	KVF650 Brute Force 4x4i	05-14	268204	10,66€			KN204	18,10€				
650	KVF650 Prairie	01-03	268204	10,66€			KN204	18,10€				
700	KFX700 V-Force	04-11	268204	10,66€			KN204	18,10€				
700	KSV700 V-Force	04-11	268204	10,66€			KN204	18,10€				
700	KVF700 Prairie	04-11	268204	10,66€			KN204	18,10€				
750	KVF750 Brute Force 4x4	05-20	268204	10,66€			KN204	18,10€				
800	TERYX KRF-KRT	14-14	268204	10,66€			KN204	18,10€				
KTM												
50	SX50	09-22			267533	7,70€			267150010	6,60€		
50	SX50 Mini	19-22			267533	7,70€			267150010	6,60€		
50	SX50 Pro Junior	97-01							267150030	6,60€		
50	SX50 Pro Junior LC	02-04							267150030	6,60€		
50	SX50 Pro Senior	00-01			267535	7,70€			267150020	6,60€		
50	SX50 Pro Senior LC	02-06			267535	7,70€			267150020	6,60€		
60	SX60	98-01			267536	12,50€			267150040	20,20€	267KTM050	20,20€
65	SX65	00-22			267536	12,50€			267150040	20,20€	267KTM050	20,20€
85	SX85	03-03			267540	12,50€			267150420	20,20€		
85	SX85	04-12			267541	-			267150430	20,20€		
85	SX85	13-17			267538	12,50€			267150110	20,20€	267KTM030*	22,40€
85	SX85	18-22							267150180	20,20€		
125	EXC125 Enduro	98-03			267540	12,50€			267150420	20,20€		
125	EXC125 Enduro	04-06			267541	-			267150430	20,20€		
125	EXC125 Enduro	07-07							267150070	20,20€		
125	EXC125 Enduro	08-11							267150070	20,20€		
125	EXC125 Enduro	12-16			267538	12,50€			267150110	20,20€	267KTM030*	22,40€
125	EXC125 Enduro	17-18			267539	12,50€			267150160	20,20€		
125	SX125	98-03			267540	12,50€			267150420	20,20€		
125	SX125	04-06			267541	-			267150430	20,20€		
125	SX125	07-09							267150070	20,20€		
125	SX125	10-10							267150070	20,20€		
125	SX125	11-15			267538	12,50€			267150110	20,20€	267KTM030*	22,40€
125	SX125	16-22			267539	12,50€			267150160	20,20€		
125	XC125 W Enduro	19-19			267539	12,50€			267150160	20,20€		
150	EXC150 TPI Enduro	20-22			267539	12,50€			267150160	20,20€		
150	SX144	07-08							267150070	20,20€		
150	SX150	09-10							267150070	20,20€		
150	SX150	11-15			267538	12,50€			267150110	20,20€	267KTM030*	22,40€
150	SX150	16-22			267539	12,50€			267150160	20,20€		
200	EXC200 Enduro	08-11							267150070	20,20€		
200	EXC200 Enduro	12-15			267538	12,50€			267150110	20,20€	267KTM030*	22,40€
200	EXC200 Enduro	16-16			267539	12,50€			267150160	20,20€		
250	EXC250 Enduro	97-00			267540	12,50€			267150420	20,20€		
250	EXC250 Enduro	01-02			267541	-			267150430	20,20€		
250	EXC250 Enduro	03-06	268155 268157	7,15€ 7,15€	267541	-	KN155 KN157	10,50€ 11,05€	267150430	20,20€		
250	EXC250 Enduro	07-07			267541	-			267150430	20,20€		
250	EXC250 Enduro	08-11							267150070	20,20€		
250	EXC250 Enduro	12-17			267538	12,50€			267150110	20,20€		
250	EXC250 Racing	02-03			267540	12,50€			267150420	20,20€		



Cyl	Modèle	Année	EVO	€ T.T.C.	COUVERCLE DE NETTOYAGE	€ T.T.C.	CAGE ALU STANDARD	€ T.T.C.	CAGE ALU EVO	€ T.T.C.
KAWASAKI										
360	KVF360 Prairie 2x4	03-09								
360	KVF360 Prairie 4x4	03-13								
400	KFX400 (KSF [US])	02-06								
400	KLF400 Bayou	93-99								
400	KVF400 Prairie	97-98								
400	KVF400 Prairie 2x4	99-02								
400	KVF400 Prairie 4x4	99-02								
450	KFX450 R	07-14								
450	KLX450 R	05-07								
450	KLX450 R	08-15								
450	KX450 F	06-15	267E140060	22,40€	267KXF0011BL	25,00€				
450	KX450 F	16-18	267E140160	22,40€	267KXF0016BL	25,00€	267AIRCKAW16	163,20€		
450	KX450 F - KX	19-22	267E140190	22,50€	267KXF0019BL	25,00€	267AIRCKAW19	-		
450	KX450 X Enduro (KL)	22-22	267E140190	22,50€	267KXF0019BL	25,00€	267AIRCKAW19	-		
650	KFX650 V-Force	01-02								
650	KLX650 C	93-95								
650	KLX650 R	93-01								
650	KVF650 Brute Force 4x4i	05-14								
650	KVF650 Prairie	01-03								
700	KFX700 V-Force	04-11								
700	KSV700 V-Force	04-11								
700	KVF700 Prairie	04-11								
750	KVF750 Brute Force 4x4	05-20								
800	TERYX KRF-KRT	14-14								
KTM										
50	SX50	09-22								
50	SX50 Mini	19-22								
50	SX50 Pro Junior	97-01								
50	SX50 Pro Junior LC	02-04								
50	SX50 Pro Senior	00-01								
50	SX50 Pro Senior LC	02-06								
60	SX60	98-01								
65	SX65	00-22								
85	SX85	03-03			267KTM0011BL	25,00€				
85	SX85	04-12			267KTM0011BL	25,00€				
85	SX85	13-17	267EKTMO30*	22,40€	267KTM0011BL	25,00€	26780850	91,80€	26780910*	91,80€
85	SX85	18-22			267KTM0018BL	25,00€	267AIRCKTM18	130,80€		
125	EXC125 Enduro	98-03			267KTM0011BL	25,00€				
125	EXC125 Enduro	04-06			267KTM0011BL	25,00€				
125	EXC125 Enduro	07-07			267KTM0011BL	25,00€				
125	EXC125 Enduro	08-11			267KTM0011BL	25,00€			26780840	91,80€
125	EXC125 Enduro	12-16	267EKTMO30*	22,40€	267KTM0011BL	25,00€	26780850	91,80€	26780910*	91,80€
125	EXC125 Enduro	17-18	267E150160	22,40€	267KTM0016BL	25,00€	267AIRCKTM16	130,80€		
125	SX125	98-03			267KTM0011BL	25,00€				
125	SX125	04-06			267KTM0011BL	25,00€				
125	SX125	07-09			267KTM0011BL	25,00€			26780840	91,80€
125	SX125	10-10			267KTM0011BL	25,00€			26780840	91,80€
125	SX125	11-15	267EKTMO30*	22,40€	267KTM0011BL	25,00€	26780850	91,80€	26780910*	91,80€
125	SX125	16-22	267E150160	22,40€	267KTM0016BL	25,00€	267AIRCKTM16	130,80€		
125	XC125 W Enduro	19-19	267E150160	22,40€	267KTM0016BL	25,00€	267AIRCKTM16	130,80€		
150	EXC150 TPI Enduro	20-22			267KTM0016BL	25,00€	267AIRCKTM16	130,80€		
150	SX144	07-08			267KTM0011BL	25,00€				
150	SX150	09-10			267KTM0011BL	25,00€				
150	SX150	11-15	267EKTMO30*	22,40€	267KTM0011BL	25,00€	26780850	91,80€	26780910*	91,80€
150	SX150	16-22	267E150160	22,40€	267KTM0016BL	25,00€	267AIRCKTM16	130,80€		
200	EXC200 Enduro	08-11			267KTM0011BL	25,00€				
200	EXC200 Enduro	12-15	267EKTMO30*	22,40€	267KTM0011BL	25,00€	26780850	91,80€	26780910*	91,80€
200	EXC200 Enduro	16-16	267E150160	22,40€	267KTM0016BL	25,00€	267AIRCKTM16	130,80€		
250	EXC250 Enduro	97-00			267KTM0011BL	25,00€				
250	EXC250 Enduro	01-02			267KTM0011BL	25,00€				
250	EXC250 Enduro	03-06			267KTM0011BL	25,00€				
250	EXC250 Enduro	07-07			267KTM0011BL	25,00€				
250	EXC250 Enduro	08-11			267KTM0011BL	25,00€			26780840	91,80€
250	EXC250 Enduro	12-17			267KTM0011BL	25,00€				
250	EXC250 Racing	02-03			267KTM0011BL	25,00€				

FILTRATION



Cyl	Modèle	Année	FILTRE À HUILE € T.T.C.		FILTRE À AIR MOUSSE € T.T.C.		FILTRE À HUILE € T.T.C.		DOUBLE MOUSSE € T.T.C.		TRIPLE MOUSSE € T.T.C.	
KTM												
250	EXC250 Racing	04-07			267541	-			267150430	20,20€		
250	EXC250 Racing	08-11							267150070	20,20€		
250	EXC250 Racing	12-15			267538	12,50€			267150110	20,20€		
250	EXC250 TPI Enduro	18-22			267539	12,50€			267150160	20,20€		
250	EXC250-F Enduro	07-07	268655	7,60€			KN655	11,35€	267150070	20,20€		
250	EXC250-F Enduro	08-11	268655	7,60€			KN655	11,35€	267150070	20,20€		
250	EXC250-F Enduro	12-13	268655	7,60€	267538	12,50€	KN655	11,35€	267150110	20,20€		
250	EXC250-F Enduro	14-16	268652	7,36€	267538	12,50€	KN652	11,35€	267150110	20,20€		
250	EXC250-F Enduro	17-22	268652	7,36€	267539	12,50€	KN652	11,35€	267150160	20,20€		
250	Freeride	13-17							267KTM075' 267KTM070	181,90€ 25,50€		
250	Freeride F	18-20	268652	7,36€			KN652	11,35€	267KTM065' 267KTM060	166,20€ 24,50€		
250	SX250 2T	04-06			267541	-			267150430	20,20€		
250	SX250 2T	07-10							267150070	20,20€		
250	SX250 2T	11-15			267538	12,50€			267150110	20,20€	267KTM030*	22,40€
250	SX250 2T	16-16							267150070	20,20€		
250	SX250 2T	17-22			267539	12,50€			267150160	20,20€		
250	SX250-F	05-06	268655	7,60€	267541	-	KN655	11,35€	267150430	20,20€		
250	SX250-F	07-10	268655	7,60€			KN655	11,35€	267150070	20,20€		
250	SX250-F	11-12	268655	7,60€	267538	12,50€	KN655	11,35€	267150110	20,20€	267KTM030*	22,40€
250	SX250-F	13-15	268652	7,36€	267538	12,50€	KN652	11,35€	267150110	20,20€	267KTM030*	22,40€
250	SX250-F	16-22	268652	7,36€	267539	12,50€	KN652	11,35€	267150160	20,20€		
300	EGS300	98-99			267540	12,50€			267150420	20,20€		
300	EXC300 Enduro	98-03			267540	12,50€			267150420	20,20€		
300	EXC300 Enduro	04-07			267541	-			267150430	20,20€		
300	EXC300 Enduro	08-11							267150070	20,20€		
300	EXC300 Enduro	12-16			267538	12,50€			267150110	20,20€	267KTM030*	22,40€
300	EXC300 Enduro	17-17			267539	12,50€			267150160	20,20€		
300	EXC300 TPI Enduro	18-22			267539	12,50€			267150160	20,20€		
350	EXC350-F	12-16	268652	7,36€	267538	12,50€	KN652	11,35€	267150110	20,20€	267KTM030*	22,40€
350	EXC350-F	17-22	268652	7,36€	267539	12,50€	KN652	11,35€	267150160	20,20€		
350	Freeride 350	12-17	268652	7,36€			KN652	11,35€	267KTM065' 267KTM060	166,20€ 24,50€		
350	SX350-F	11-15	268652	7,36€	267538	12,50€	KN652	11,35€	267150110	20,20€	267KTM030*	22,40€
350	SX350-F	16-22	268652	7,36€	267539	12,50€	KN652	11,35€	267150160	20,20€		
360	EGS360	96-97			267540	12,50€			267150420	20,20€		
360	EXC360	96-97			267540	12,50€			267150420	20,20€		
360	SX360	96-98			267540	12,50€			267150420	20,20€		
380	EGS380	98-99			267540	12,50€			267150420	20,20€		
380	EXC380	98-02			267540	12,50€			267150420	20,20€		
380	SX380	98-02			267540	12,50€			267150420	20,20€		
380	XC380	98-99			267540	12,50€			267150420	20,20€		
400	EGS400 LC4	93-98	268155 268156	7,15€ 12,20€			KN155	10,50€				
400	EGS400 LC4 LSE	97-98	268155 268157	7,15€ 7,15€			KN155 KN157	10,50€ 11,05€				
400	EGS400 LC4-E	99-99	268155 268156	7,15€ 12,20€			KN155	10,50€				
400	EGS400 LC4-E 2T	00-01	268155 268156	7,15€ 12,20€			KN155	10,50€				
400	EGS400 LC4-E 4T	01-01	268155 268156	7,15€ 12,20€			KN155	10,50€				
400	EXC400	00-07	268155 268157	7,15€ 7,15€			KN155 KN157	10,50€ 11,05€				
400	EXC400	08-10	268652	7,36€			KN652	11,35€	267150070	20,20€		
400	EXC400	11-11	268652	7,36€			KN652	11,35€				
400	MXC400	00-02	268155 268157	7,15€ 7,15€			KN155 KN157	10,50€ 11,05€				
400	SX400 Enduro	00-02	268155 268157	7,15€ 7,15€			KN155 KN157	10,50€ 11,05€				
400	SX400 Racing	00-02	268155 268157	7,15€ 7,15€			KN155 KN157	10,50€ 11,05€				
400	SXC400 Tiainen Replica	99-00	268155 268156	7,15€ 12,20€			KN155	10,50€				
440	EXC440	94-95							267250020	20,20€		
450	EXC450-F	03-06	268155 268157	7,15€ 7,15€	267541	-	KN155 KN157	10,50€ 11,05€	267150430	20,20€		
450	EXC450-F	07-07	268155	7,15€	267541	-	KN155 KN157	10,50€ 11,05€	267150430	20,20€		
450	EXC450-F	08-11	268652	7,36€			KN652	11,35€	267150070	20,20€		



Cyl	Modèle	Année	EVO	€ T.T.C.	COUVERCLE DE NETTOYAGE	€ T.T.C.	CAGE ALU STANDARD	€ T.T.C.	CAGE ALU EVO	€ T.T.C.
KTM										
250	EXC250 Racing	04-07			267KTM0011BL	25,00€				
250	EXC250 Racing	08-11			267KTM0011BL	25,00€			26780840	91,80€
250	EXC250 Racing	12-15			267KTM0011BL	25,00€				
250	EXC250 TPI Enduro	18-22	267E150160	22,40€	267KTM0016BL	25,00€	267AIRCKTM16	130,80€		
250	EXC250-F Enduro	07-07			267KTM0011BL	25,00€				
250	EXC250-F Enduro	08-11			267KTM0011BL	25,00€			26780840	91,80€
250	EXC250-F Enduro	12-13			267KTM0011BL	25,00€				
250	EXC250-F Enduro	14-16			267KTM0011BL	25,00€				
250	EXC250-F Enduro	17-22	267E150160	22,40€	267KTM0016BL	25,00€	267AIRCKTM16	130,80€		
250	Freeride	13-17					26780830	110,40€		
250	Freeride F	18-20					26780820	106,20€		
250	SX250 2T	04-06			267KTM0011BL	25,00€				
250	SX250 2T	07-10			267KTM0011BL	25,00€			26780840	91,80€
250	SX250 2T	11-15	267EKTMO30*	22,40€	267KTM0011BL	25,00€	26780850	91,80€	26780910*	91,80€
250	SX250 2T	16-16			267KTM0011BL	25,00€			26780840	91,80€
250	SX250 2T	17-22	267E150160	22,40€	267KTM0016BL	25,00€	267AIRCKTM16	130,80€		
250	SX250-F	05-06			267KTM0011BL	25,00€				
250	SX250-F	07-10			267KTM0011BL	25,00€			26780840	91,80€
250	SX250-F	11-12	267EKTMO30*	22,40€	267KTM0011BL	25,00€	26780850	91,80€	26780910*	91,80€
250	SX250-F	13-15	267EKTMO30*	22,40€	267KTM0011BL	25,00€	26780850	91,80€	26780910*	91,80€
250	SX250-F	16-22	267E150160	22,40€	267KTM0016BL	25,00€	267AIRCKTM16	130,80€		
300	EGS300	98-99			267KTM0011BL	25,00€				
300	EXC300 Enduro	98-03			267KTM0011BL	25,00€				
300	EXC300 Enduro	04-07			267KTM0011BL	25,00€				
300	EXC300 Enduro	08-11			267KTM0011BL	25,00€				
300	EXC300 Enduro	12-16	267EKTMO30*	22,40€	267KTM0011BL	25,00€	26780850	91,80€	26780910*	91,80€
300	EXC300 Enduro	17-17	267E150160	22,40€	267KTM0016BL	25,00€	267AIRCKTM16	130,80€		
300	EXC300 TPI Enduro	18-22	267E150160	22,40€	267KTM0016BL	25,00€	267AIRCKTM16	130,80€		
350	EXC350-F	12-16	267EKTMO30*	22,40€	267KTM0011BL	25,00€	26780850	91,80€	26780910*	91,80€
350	EXC350-F	17-22	267E150160	22,40€	267KTM0016BL	25,00€	267AIRCKTM16	130,80€		
350	Freeride 350	12-17					26780820	106,20€		
350	SX350-F	11-15	267EKTMO30*	22,40€	267KTM0011BL	25,00€	26780850	91,80€	26780910*	91,80€
350	SX350-F	16-22	267E150160	22,40€	267KTM0016BL	25,00€	267AIRCKTM16	130,80€		
360	EGS360	96-97			267KTM0011BL	25,00€				
360	EXC360	96-97			267KTM0011BL	25,00€				
360	SX360	96-98			267KTM0011BL	25,00€				
380	EGS380	98-99			267KTM0011BL	25,00€				
380	EXC380	98-02			267KTM0011BL	25,00€				
380	SX380	98-02			267KTM0011BL	25,00€				
380	XC380	98-99			267KTM0011BL	25,00€				
400	EGS400 LC4	93-98								
400	EGS400 LC4 LSE	97-98								
400	EGS400 LC4-E	99-99								
400	EGS400 LC4-E 2T	00-01								
400	EGS400 LC4-E 4T	01-01								
400	EXC400	00-07								
400	EXC400	08-10			267KTM0011BL	25,00€				
400	EXC400	11-11								
400	MXC400	00-02								
400	SX400 Enduro	00-02								
400	SX400 Racing	00-02								
400	SXC400 Tiainen Replica	99-00								
440	EXC440	94-95								
450	EXC450-F	03-06			267KTM0011BL	25,00€				
450	EXC450-F	07-07			267KTM0011BL	25,00€				
450	EXC450-F	08-11			267KTM0011BL	25,00€			26780840	91,80€

FILTRATION



Cyl	Modèle	Année	FILTRE À HUILE	€ T.T.C.	FILTRE À AIR MOUSSE	€ T.T.C.	FILTRE À HUILE	€ T.T.C.	DOUBLE MOUSSE	€ T.T.C.	TRIPLE MOUSSE	€ T.T.C.
KTM												
450	EXC450-F	12-12	268655	7,60€	267538	12,50€	KN655	11,35€	267150110	20,20€	267KTM030*	22,40€
450	EXC450-F	13-15	268655	7,60€	267538	12,50€	KN655	11,35€	267150110	20,20€	267KTM030*	22,40€
450	EXC450-F	16-16	268652	7,36€	267538	12,50€	KN652	11,35€	267150110	20,20€	267KTM030*	22,40€
450	EXC450-F	17-22	268652	7,36€	267539	12,50€	KN652	11,35€	267150160	20,20€		
450	EXC450-R	02-02	268155 268157	7,15€ 7,15€			KN155 KN157	10,50€ 11,05€				
450	EXC450-R	03-07	268155 268157	7,15€ 7,15€	267541	-	KN155 KN157	10,50€ 11,05€	267150430	20,20€		
450	EXC450-R	08-08	268655	7,60€			KN655	11,35€	267150070	20,20€		
450	EXC450-R	09-11	268652	7,36€			KN652	11,35€	267150070	20,20€		
450	EXC450-R	12-16	268655	7,60€	267538	12,50€	KN655	11,35€	267150110	20,20€	267KTM030*	22,40€
450	MXC450	03-06	268155 268157	7,15€ 7,15€			KN155 KN157	10,50€ 11,05€				
450	RFR Rallye Factory Replica	11-14	268650	10,36€								
450	SC450 F	08-13	268652	7,36€			KN652	11,35€				
450	SMR450	04-07	268155 268157	7,15€ 7,15€			KN155 KN157	10,50€ 11,05€				
450	SMR450	08-11	268155 268157	7,15€ 7,15€			KN155 KN157	10,50€ 11,05€	267150070	20,20€		
450	SMR450	12-14	268155 268157	7,15€ 7,15€	267538	12,50€	KN155 KN157	10,50€ 11,05€	267150110	20,20€	267KTM030*	22,40€
450	SMR450	21-21	268652	7,36€	267539	12,50€	KN652	11,35€	267150160	20,20€		
450	SX450 ATV	08-13	268650	10,36€								
450	SX450 Racing	03-06	268155 268157	7,15€ 7,15€			KN155 KN157	10,50€ 11,05€				
450	SX450 Racing	15-15	268655	7,60€			KN655	11,35€				
450	SX450-F	03-06	268155 268157	7,15€ 7,15€	267541	-	KN155 KN157	10,50€ 11,05€	267150430	20,20€		
450	SX450-F	07-10	268652	7,36€			KN652	11,35€	267150070	20,20€		
450	SX450-F	11-12	268652	7,36€	267538	12,50€	KN652	11,35€	267150110	20,20€	267KTM030*	22,40€
450	SX450-F	13-15	268655	7,60€	267538	12,50€	KN655	11,35€	267150110	20,20€	267KTM030*	22,40€
450	SX450-F	16-16	268655	7,60€	267539	12,50€	KN655	11,35€	267150160	20,20€		
450	SX450-F	17-22	268652	7,36€	267539	12,50€	KN652	11,35€	267150160	20,20€		
450	XC450 ATV	08-13	268155 268157	7,15€ 7,15€			KN155 KN157	10,50€ 11,05€				
450	XC450-F	07-07	268155 268157	7,15€ 7,15€			KN155 KN157	10,50€ 11,05€	267150430	20,20€		
450	XC450-F	08-11	268652	7,36€			KN652	11,35€	267150070	20,20€		
450	XC450-F	12-13	268655	7,60€	267538	12,50€	KN655	11,35€	267150110	20,20€	267KTM030*	22,40€
450	XC450-W /WR	08-12	268652	7,36€			KN652	11,35€				
450	XC450-W /WR	13-13	268652	7,36€			KN652	11,35€				
500	EXC500-F	12-16	268655	7,60€	267538	12,50€	KN655	11,35€	267150110	20,20€	267KTM030*	22,40€
500	EXC500-F	17-22	268652	7,36€	267539	12,50€	KN652	11,35€	267150160	20,20€		
505	SX505	09-13	268652	7,36€			KN652	11,35€				
505	SX505 ATV	08-13	268650	10,36€								
505	SX505 F Racing	07-09	268652	7,36€			KN652	11,35€	267150070	20,20€		
505	SX505 F Racing (US)	07-09	268652	7,36€			KN652	11,35€				
505	XC505 ATV	09-13	268658	9,40€								
505	XC505-F	09-10	268652	7,36€			KN652	11,35€	267150070	20,20€		
505	XC505-F	11-13	268652	7,36€			KN652	11,35€				
520	EXC520 Racing	99-99	268155 268157	7,15€ 7,15€			KN155 KN157	10,50€ 11,05€				
520	EXC520 Racing 4T (> 04/2002)	01-02	268155 268157	7,15€ 7,15€			KN155 KN157	10,50€ 11,05€				
520	MXC520	99-99	268155 268157	7,15€ 7,15€			KN155 KN157	10,50€ 11,05€				
520	MXC520 2T	00-02	268155 268157	7,15€ 7,15€			KN155 KN157	10,50€ 11,05€				
520	MXC520 4T	01-02	268155 268157	7,15€ 7,15€			KN155 KN157	10,50€ 11,05€				
520	SX520 Racing	99-99	268155 268157	7,15€ 7,15€			KN155 KN157	10,50€ 11,05€				
520	SX520 Racing	00-02	268155 268157	7,15€ 7,15€			KN155 KN157	10,50€ 11,05€				
525	EXC525 Racing 4T	03-07	268155 268157	7,15€ 7,15€			KN155 KN157	10,50€ 11,05€				
525	MXC525 2T	03-03	268155 268157	7,15€ 7,15€			KN155 KN157	10,50€ 11,05€				
525	MXC525 4T	03-06	268155 268157	7,15€ 7,15€			KN155 KN157	10,50€ 11,05€				
525	SX525 Racing 2T	03-03	268155 268157	7,15€ 7,15€			KN155 KN157	10,50€ 11,05€				



Cyl	Modèle	Année	EVO	€ T.T.C.	COUVERCLE DE NETTOYAGE	€ T.T.C.	CAGE ALU STANDARD	€ T.T.C.	CAGE ALU EVO	€ T.T.C.
KTM										
450	EXC450-F	12-12	267EKTMO30*	22,40€	267KTM0011BL	25,00€	26780850	91,80€	26780910*	91,80€
450	EXC450-F	13-15	267EKTMO30*	22,40€	267KTM0011BL	25,00€			26780910*	
450	EXC450-F	16-16	267EKTMO30*	22,40€	267KTM0011BL	25,00€			26780910*	
450	EXC450-F	17-22	267E150160	22,40€	267KTM0016BL	25,00€	267AIRCKTM16	130,80€		
450	EXC450-R	02-02								
450	EXC450-R	03-07			267KTM0011BL	25,00€				
450	EXC450-R	08-08			267KTM0011BL	25,00€				
450	EXC450-R	09-11			267KTM0011BL	25,00€				
450	EXC450-R	12-16	267EKTMO30*	22,40€	267KTM0011BL	25,00€	26780850	91,80€	26780910*	91,80€
450	MXC450	03-06								
450	RFR Rallye Factory Replica	11-14								
450	SC450 F	08-13								
450	SMR450	04-07								
450	SMR450	08-11			267KTM0011BL	25,00€				
450	SMR450	12-14	267EKTMO30*	22,40€	267KTM0011BL	25,00€	26780850	91,80€	26780910*	91,80€
450	SMR450	21-21	267E150160	22,40€	267KTM0016BL	25,00€	267AIRCKTM16	130,80€		
450	SX450 ATV	08-13			267KTM0011BL	25,00€				
450	SX450 Racing	03-06								
450	SX450 Racing	15-15								
450	SX450-F	03-06			267KTM0011BL	25,00€				
450	SX450-F	07-10			267KTM0011BL	25,00€			26780840	91,80€
450	SX450-F	11-12	267EKTMO30*	22,40€	267KTM0011BL	25,00€	26780850	91,80€	26780910*	91,80€
450	SX450-F	13-15	267EKTMO30*	22,40€	267KTM0011BL	25,00€	26780850	91,80€	26780910*	91,80€
450	SX450-F	16-16	267E150160	22,40€	267KTM0016BL	25,00€	267AIRCKTM16	130,80€		
450	SX450-F	17-22	267E150160	22,40€	267KTM0016BL	25,00€	267AIRCKTM16	130,80€		
450	XC450 ATV	08-13								
450	XC450-F	07-07			267KTM0011BL	25,00€				
450	XC450-F	08-11			267KTM0011BL	25,00€				
450	XC450-F	12-13	267EKTMO30*	22,40€	267KTM0011BL	25,00€	26780850	91,80€	26780910*	91,80€
450	XC450-W /WR	08-12								
450	XC450-W /WR	13-13	267EKTMO30*	22,40€			26780850	91,80€	26780910*	91,80€
500	EXC500-F	12-16	267EKTMO30*	22,40€	267KTM0011BL	25,00€	26780850	91,80€	26780910*	91,80€
500	EXC500-F	17-22	267E150160	22,40€	267KTM0016BL	25,00€	267AIRCKTM16	130,80€		
505	SX505	09-13								
505	SX505 ATV	08-13								
505	SX505 F Racing	07-09			267KTM0011BL	25,00€				
505	SX505 F Racing (US)	07-09								
505	XC505 ATV	09-13								
505	XC505-F	09-10			267KTM0011BL	25,00€				
505	XC505-F	11-13								
520	EXC520 Racing	99-99								
520	EXC520 Racing 4T (> 04/2002)	01-02								
520	MXC520	99-99								
520	MXC520 2T	00-02								
520	MXC520 4T	01-02								
520	SX520 Racing	99-99								
520	SX520 Racing	00-02								
525	EXC525 Racing 4T	03-07								
525	MXC525 2T	03-03								
525	MXC525 4T	03-06								
525	SX525 Racing 2T	03-03								

FILTRATION



Cyl	Modèle	Année	FILTRE À HUILE	€ T.T.C.	FILTRE À AIR MOUSSE	€ T.T.C.	FILTRE À HUILE	€ T.T.C.	DOUBLE MOUSSE	€ T.T.C.	TRIPLE MOUSSE	€ T.T.C.
KTM												
525	SX525 Racing 4T	03-08	268155 268157	7,15€ 7,15€			KN155 KN157	10,50€ 11,05€				
525	XC525 ATV	08-13	268155 268157	7,15€ 7,15€			KN155 KN157	10,50€ 11,05€				
530	EXC530	08-09	268652	7,36€			KN652	11,35€	267150070	20,20€		
530	EXC530	10-11	268652	7,36€			KN652	11,35€				
530	SX530 Racing	08-08	268652	7,36€			KN652	11,35€				
540	SXC540 Tiainen Replica	98-00	268155 268157	7,15€ 7,15€			KN155 KN157	10,50€ 11,05€				
560	SMR560	06-07	268155 268157	7,15€ 7,15€			KN155 KN157	10,50€ 11,05€				
620	EXC620 LC4	94-99	268155 268156	7,15€ 12,20€			KN155	10,50€	267250020	20,20€		
620	SC620	96-02	268155	7,15€			KN155	10,50€				
620	SX620 LC4	94-99	268155 268156	7,15€ 12,20€			KN155	10,50€				
620	SXC620 LC4	00-02	268155 268156	7,15€ 12,20€			KN155	10,50€				
690	Enduro 690	08-11	268155 268157	7,15€ 7,15€			KN155 KN157	10,50€ 11,05€				
690	Enduro 690	12-15	268651 268155	7,15€ 7,15€			KN155	10,50€				
690	Enduro 690 R	09-11	268155 268157	7,15€ 7,15€			KN155 KN157	10,50€ 11,05€				
690	Enduro 690 R	12-21	268651 268155	7,15€ 7,15€			KN155	10,50€				
KYMCO												
400	MXU400	12-17	268138	10,66€			KN138	18,10€				
450	Maxxer 450 I	12-19	268138	10,66€			KN138	18,10€				
450	UXV i 450	14-21	268138	10,66€			KN138	18,10€				
450	UXV i Sport 450	15-15	268138	10,66€			KN138	18,10€				
500	MXU500	06-17	268147	10,66€			KN147	18,25€				
500	UXV i 500	12-15	268147	10,66€			KN147	18,25€				
550	MXU550 I	14-21	268147	10,66€			KN147	18,25€				
700	MXU700 I	18-21	268147	10,66€			KN147	18,25€				
700	UXV i 700	14-21	268147	10,66€			KN147	18,25€				
700	UXV i 700 Sport	15-15	268147	10,66€			KN147	18,25€				
MONTESA												
250	Cota 315R 250	97-00										
250	Cota 4RT 250	05-13	268116	5,20€			KN116	10,00€				
260	Cota 4RT 260	14-19										
260	Cota 4RT 260 Race Replica	15-16										
MUZ												
125	SM125	99-11	268151	8,10€			KN151	11,75€				
125	SX125	99-11	268151	8,10€			KN151	11,75€				
POLARIS												
200	Phoenix 200	05-14	268197	10,66€								
200	Sawtooth	06-07	268197	10,66€								
300	Hawkeye 2x4 300	06-13	268303	10,66€			KN303	18,10€				
300	Hawkeye 4x4 300	06-13	268303	10,66€			KN303	18,10€				
300	Sportsman 300	08-13	268303	10,66€			KN303	18,10€				
300	Xpress 300 L	96-99	268303	10,66€			KN303	18,10€				
325	Magnum 2x4 325	00-02	268303	10,66€			KN303	18,10€				
325	Magnum 4x4 325	00-02	268303	10,66€			KN303	18,10€				
325	Sportsman 325	14-15	268116	5,20€			KN116	10,00€				
325	Trail Boss 325	00-02	268303	10,66€			KN303	18,10€				
325	Xpedition 325	00-02	268303	10,66€			KN303	18,10€				
330	ATP330	04-07	268303	10,66€			KN303	18,10€				
330	Hawkeye 2x4 330	06-06	268303	10,66€			KN303	18,10€				
330	Hawkeye 4x4 330	06-06	268303	10,66€			KN303	18,10€				
330	Magnum 2x4 330	03-06	268303	10,66€			KN303	18,10€				
330	Magnum 4x4 330	03-06	268303	10,66€			KN303	18,10€				
330	Trail Blazer 2x4 330	08-11	268303	10,66€			KN303	18,10€				
330	Trail Blazer 2x4 330	12-13	268199	10,85€			KN303	18,10€				
330	Trail Boss 2x4 330	03-11	268303	10,66€			KN303	18,10€				
330	Trail Boss 2x4 330	12-13	268199	10,85€			KN303	18,10€				
335	Sportsman 4x4 335	99-01	268303	10,66€			KN303	18,10€				
400	Scrambler 4x4 400	00-02	268138	10,66€			KN138	18,10€				
400	Scrambler 4x4 400 L	95-97	268138	10,66€			KN138	18,10€				



Cyl	Modèle	Année	EVO	€ T.T.C.	COUVERCLE DE NETTOYAGE	€ T.T.C.	CAGE ALU STANDARD	€ T.T.C.	CAGE ALU EVO	€ T.T.C.
KTM										
525	SX525 Racing 4T	03-08								
525	XC525 ATV	08-13			267KTM0011BL	25,00€				
530	EXC530	08-09			267KTM0011BL	25,00€				
530	EXC530	10-11								
530	SX530 Racing	08-08								
540	SXC540 Tiainen Replica	98-00								
560	SMR560	06-07								
620	EXC620 LC4	94-99								
620	SC620	96-02								
620	SX620 LC4	94-99								
620	SXC620 LC4	00-02								
690	Enduro 690	08-11								
690	Enduro 690	12-15								
690	Enduro 690 R	09-11								
690	Enduro 690 R	12-21								
KYMCO										
400	MXU400	12-17								
450	Maxxer 450 I	12-19								
450	UXV i 450	14-21								
450	UXV i Sport 450	15-15								
500	MXU500	06-17								
500	UXV i 500	12-15								
550	MXU550 I	14-21								
700	MXU700 I	18-21								
700	UXV i 700	14-21								
700	UXV i 700 Sport	15-15								
MONTESA										
250	Cota 315R 250	97-00			267720010	25,00€				
250	Cota 4RT 250	05-13			267720050	25,00€				
260	Cota 4RT 260	14-19			267720010	25,00€				
260	Cota 4RT 260 Race Replica	15-16			267720010	25,00€				
MUZ										
125	SM125	99-11								
125	SX125	99-11								
POLARIS										
200	Phoenix 200	05-14								
200	Sawtooth	06-07								
300	Hawkeye 2x4 300	06-13								
300	Hawkeye 4x4 300	06-13								
300	Sportsman 300	08-13								
300	Xpress 300 L	96-99								
325	Magnum 2x4 325	00-02								
325	Magnum 4x4 325	00-02								
325	Sportsman 325	14-15								
325	Trail Boss 325	00-02								
325	Xpedition 325	00-02								
330	ATP330	04-07								
330	Hawkeye 2x4 330	06-06								
330	Hawkeye 4x4 330	06-06								
330	Magnum 2x4 330	03-06								
330	Magnum 4x4 330	03-06								
330	Trail Blazer 2x4 330	08-11								
330	Trail Blazer 2x4 330	12-13								
330	Trail Boss 2x4 330	03-11								
330	Trail Boss 2x4 330	12-13								
335	Sportsman 4x4 335	99-01								
400	Scrambler 4x4 400	00-02								
400	Scrambler 4x4 400 L	95-97								

FILTRATION



Cyl	Modèle	Année	FILTRE À HUILE	€ T.T.C.	FILTRE À AIR MOUSSE	€ T.T.C.	FILTRE À HUILE	€ T.T.C.	DOUBLE MOUSSE	€ T.T.C.	TRIPLE MOUSSE	€ T.T.C.
POLARIS												
400	Sport 400 L	94-94	268138	10,66€			KN138	18,10€				
400	Sport 400 L	95-00	268303	10,66€			KN303	18,10€				
400	Sportsman 400	01-05	268303	10,66€			KN303	18,10€				
400	Sportsman 400 HO	08-12	268303	10,66€			KN303	18,10€				
400	Sportsman 400 HO	13-13	268199	10,85€								
400	Xplorer 4x4 400 L	95-01	268303	10,66€			KN303	18,10€				
425	Magnum 2x4 425	95-98	268303	10,66€			KN303	18,10€				
425	Magnum 4x4 425	95-98	268303	10,66€			KN303	18,10€				
425	Magnum 6x6 425	96-97	268303	10,66€			KN303	18,10€				
425	Ranger 425	01-03	268303	10,66€			KN303	18,10€				
425	Xpedition 4x4 425	00-02	268303	10,66€			KN303	18,10€				
450	Outlaw 450 MXR /S	08-11	268155 268157	7,15€ 7,15€			KN155 KN157	10,50€ 11,05€				
450	Sportsman 450	06-07	268303	10,66€			KN303	18,10€				
500	ATP500 HO	04-05	268303	10,66€			KN303	18,10€				
500	Big Boss 6x6 500	98-99	268303	10,66€			KN303	18,10€				
500	Magnum 2x4 500	02-02	268303	10,66€			KN303	18,10€				
500	Magnum 4x4 500	00-02	268303	10,66€			KN303	18,10€				
500	Outlaw 500	06-07	268112	4,40€			KN112	8,75€				
500	Predator 500	03-07	268112	4,40€			KN112	8,75€				
500	Scrambler 2x4 500	00-07	268303	10,66€			KN303	18,10€				
500	Scrambler 2x4 500 E	08-11	268303	10,66€			KN303	18,10€				
500	Scrambler 4x4 500	96-07	268303	10,66€			KN303	18,10€				
500	Scrambler 4x4 500 E	08-11	268303	10,66€			KN303	18,10€				
500	Scrambler 4x4 500 E	12-12	268199	10,85€			KN303	18,10€				
500	Sportsman 500 EFI	06-10	268303	10,66€			KN303	18,10€				
500	Sportsman 500 HO	03-11	268303	10,66€			KN303	18,10€				
500	Sportsman 500 HO	12-14	268199	10,85€			KN303	18,10€				
500	Sportsman 6x6 500	00-11	268303	10,66€			KN303	18,10€				
500	Sportsman Touring 500 EFI	08-11	268303	10,66€			KN303	18,10€				
500	Sportsman Touring 500 EFI	12-14	268199	10,85€			KN303	18,10€				
500	Sportsman X2 500	06-07	268303	10,66€			KN303	18,10€				
500	Sportsman X2 500 EFI	08-11	268303	10,66€			KN303	18,10€				
500	Sportsman X2 500 EFI	12-14	268199	10,85€			KN303	18,10€				
500	Xplorer 4x4 500	97-97	268303	10,66€			KN303	18,10€				
525	Outlaw 525 /s	07-11	268155 268157	7,15€ 7,15€			KN155 KN157	10,50€ 11,05€				
550	Sportsman XP 550 EFI	09-14	268199	10,85€								
570	Sportsman 570 EFI	15-18	268199	10,85€								
600	Sportsman 600 (> 09.02.2003)	03-04	268199	10,85€								
600	Sportsman 600 (10.02.2003 >)	04-06	268198	12,70€								
700	Ranger 6x6 EFI 700	07-13	268198	12,70€								
700	Ranger 700 Crew	09-13	268198	12,70€								
700	Ranger 700 HD	09-13	268198	12,70€								
700	Ranger 700 XP	08-13	268198	12,70€								
700	Sportsman 700	04-06	268198	12,70€								
700	Sportsman 700 EFI	05-07	268198	12,70€								
700	Sportsman 700 MV	05-06	268198	12,70€								
700	Sportsman X2 700 EFI	08-08	268198	12,70€								
800	Ranger RZR 800	08-13	268198	12,70€								
800	Sportsman 800 EFI	05-13	268198	12,70€								
800	Sportsman Big Boss 6x6	09-13	268198	12,70€								
800	Sportsman HO EFI	08-13	268198	12,70€								
800	Sportsman Touring EFI	08-13	268198	12,70€								
800	Sportsman X2 800 EFI	07-13	268198	12,70€								
850	Sportsman XP 850 EFI	09-13	268199	10,85€								
1000	Scrambler XP 1000	16-17	268199	10,85€								
1000	Sportsman XP 1000	16-17	268199	10,85€								
RIEJU												
250	MR250	22-22							267190180	20,20€		
300	MR300	21-22							267190180	20,20€		
300	MR300 Ranger	22-22							267190180	20,20€		



Cyl	Modèle	Année	EVO	€ T.T.C.	COUVERCLE DE NETTOYAGE	€ T.T.C.	CAGE ALU STANDARD	€ T.T.C.	CAGE ALU EVO	€ T.T.C.
POLARIS										
400	Sport 400 L	94-94								
400	Sport 400 L	95-00								
400	Sportsman 400	01-05								
400	Sportsman 400 HO	08-12								
400	Sportsman 400 HO	13-13								
400	Xplorer 4x4 400 L	95-01								
425	Magnum 2x4 425	95-98								
425	Magnum 4x4 425	95-98								
425	Magnum 6x6 425	96-97								
425	Ranger 425	01-03								
425	Xpedition 4x4 425	00-02								
450	Outlaw 450 MXR /S	08-11								
450	Sportsman 450	06-07								
500	ATP500 HO	04-05								
500	Big Boss 6x6 500	98-99								
500	Magnum 2x4 500	02-02								
500	Magnum 4x4 500	00-02								
500	Outlaw 500	06-07								
500	Predator 500	03-07								
500	Scrambler 2x4 500	00-07								
500	Scrambler 2x4 500 E	08-11								
500	Scrambler 4x4 500	96-07								
500	Scrambler 4x4 500 E	08-11								
500	Scrambler 4x4 500 E	12-12								
500	Sportsman 500 EFI	06-10								
500	Sportsman 500 HO	03-11								
500	Sportsman 500 HO	12-14								
500	Sportsman 6x6 500	00-11								
500	Sportsman Touring 500 EFI	08-11								
500	Sportsman Touring 500 EFI	12-14								
500	Sportsman X2 500	06-07								
500	Sportsman X2 500 EFI	08-11								
500	Sportsman X2 500 EFI	12-14								
500	Xplorer 4x4 500	97-97								
525	Outlaw 525 /s	07-11								
550	Sportsman XP 550 EFI	09-14								
570	Sportsman 570 EFI	15-18								
600	Sportsman 600 (> 09.02.2003)	03-04								
600	Sportsman 600 (10.02.2003 >)	04-06								
700	Ranger 6x6 EFI 700	07-13								
700	Ranger 700 Crew	09-13								
700	Ranger 700 HD	09-13								
700	Ranger 700 XP	08-13								
700	Sportsman 700	04-06								
700	Sportsman 700 EFI	05-07								
700	Sportsman 700 MV	05-06								
700	Sportsman X2 700 EFI	08-08								
800	Ranger RZR 800	08-13								
800	Sportsman 800 EFI	05-13								
800	Sportsman Big Boss 6x6	09-13								
800	Sportsman HO 800 EFI	08-13								
800	Sportsman Touring EFI	08-13								
800	Sportsman X2 800 EFI	07-13								
850	Sportsman XP 850 EFI	09-13								
1000	Scrambler XP 1000	16-17								
1000	Sportsman XP 1000	16-17								
RIEJU										
250	MR250	22-22								
300	MR300	21-22								
300	MR300 Ranger	22-22								

FILTRATION



Cyl	Modèle	Année	FILTRE À HUILE	€ T.T.C.	FILTRE À AIR MOUSSE	€ T.T.C.	FILTRE À HUILE	€ T.T.C.	DOUBLE MOUSSE	€ T.T.C.	TRIPLE MOUSSE	€ T.T.C.
SHERCO												
125	SE 125-R	18-22							267215010	20,20€		
250	SE 2.5i-F 250	09-13	268611	7,60€			KN611	11,05€				
250	SE-R 250	14-22							267215010	20,20€		
250	SE-R 250 Factory	14-22							267215010	20,20€		
250	SEF-R 2,5 250 4T	14-22	268611	7,60€			KN611	11,05€	267215010	20,20€		
250	SEF-R 2,5 250 4T Factory	14-22	268611	7,60€			KN611	11,05€	267215010	20,20€		
250	SX 250 2,5i-F	09-11	268611	7,60€			KN611	11,05€				
300	SE-R 3,0	13-16							267215010	20,20€		
300	SE-R 3,0 i	12-12							267215010	20,20€		
300	SE-R 300	15-22							267215010	20,20€		
300	SE-R 300 Factory	13-22							267215010	20,20€		
300	SEF-R 300 4T	14-22	268611	7,60€			KN611	11,05€	267215010	20,20€		
300	SEF-R 300 4T Factory	14-22	268611	7,60€			KN611	11,05€	267215010	20,20€		
450	Enduro 4.5i 450	04-08	268611	7,60€			KN611	11,05€				
450	SCF450	19-19	268611	7,60€			KN611	11,05€				
450	SE 4.5i-F 450	09-11	268611	7,60€			KN611	11,05€				
450	SE 4.5i-F 450	12-13	268611	7,60€			KN611	11,05€	267215010	20,20€		
450	SEF-R 450	17-21	268611	7,60€			KN611	11,05€	267215010	20,20€		
450	SEF-R 450 Factory	16-21	268611	7,60€			KN611	11,05€	267215010	20,20€		
450	SM 4.5i-F 450	09-13	268611	7,60€			KN611	11,05€				
450	Supermotard 4.5i 450	05-08	268611	7,60€			KN611	11,05€				
500	SEF-R 500	20-21	268611	7,60€			KN611	11,05€	267215010	20,20€		
500	SEF-R 500 Factory	20-21	268611	7,60€			KN611	11,05€	267215010	20,20€		
510	Enduro 5.1i 510	06-08	268611	7,60€			KN611	11,05€				
510	SE 5.1i-F 510	09-11	268611	7,60€			KN611	11,05€				
510	SM 5.1i-F 510	09-13	268611	7,60€			KN611	11,05€				
510	Supermotard 5.1i 510	07-08	268611	7,60€			KN611	11,05€				
SUZUKI												
65	RM65	03-06			267549	12,50€			267170040	20,20€		
80	RM80	86-88							267170020	20,20€		
80	RM80	89-01							267170020	20,20€		
85	RM85	02-22			267549	12,50€			267170040	20,20€		
90	LT-Z 90	07-13	268131	4,40€			KN131	9,76€				
110	DRZ110	01-07	268112	4,40€			KN112	8,75€				
125	DR-Z 125 /L	03-15	268132	4,15€			KN132	8,75€				
125	DR-Z 125 L	16-22	268132	4,15€			KN132	8,75€				
125	LT 125 E,H	84-87	268131	4,40€			KN131	9,76€				
125	RM125	87-95							267140900	20,20€		
125	RM125	96-03							267170430	20,20€		
125	RM125	04-13			267551	12,50€			267170500	20,20€		
160	LT160E Quadrunner	89-92	268132	4,15€			KN132	8,75€				
160	LT160F Quadsport	91-04	268132	4,15€			KN132	8,75€				
230	LT230 EH-EP	86-93	268132	4,15€			KN132	8,75€				
230	LT230 GEF-GEG	85-86	268132	4,15€			KN132	8,75€				
230	LT230 SF-SJ	85-88	268132	4,15€			KN132	8,75€				
250	DR-Z 250	01-10	268136	6,10€								
250	LT-F 250	00-02	268132	4,15€			KN132	8,75€				
250	LT-F 250 Ozark	02-04	268132	4,15€			KN132	8,75€				
250	LT-Z 250 Quadsport	04-10	268132	4,15€			KN132	8,75€				
250	LT250 EFF-EFG (4T)	85-85	268132	4,15€			KN132	8,75€				
250	LT250 RJ-RR (4temps)	88-88	268132	4,15€			KN132	8,75€				
250	RM-Z 250	04-06	268207	5,65€			KN207	10,10€	267170520	20,20€		
250	RM-Z 250	07-17	268207	5,65€	267551	12,50€	KN207	10,10€	267170500	20,20€		
250	RM-Z 250	18-18	268207	5,65€	267551	12,50€			267170500	20,20€		
250	RM-Z 250	19-22							267170180	20,20€		
250	RM250	87-95							267140900	20,20€		
250	RM250	96-02							267170430	20,20€		
250	RM250	03-08			267551	12,50€			267170500	20,20€		
250	RMX250	89-01							267140900	20,20€		
300	LT-F 300 Kingquad	91-11	268132	4,15€			KN132	8,75€				
400	DR-Z 400 /S	00-09	268139	5,10€	267555	12,50€	KN139	8,75€	267270020	20,20€		
400	DR-Z 400 E	00-07	268139	5,10€	267555	12,50€	KN139	8,75€	267270020	20,20€		
400	LT-A 400 Eiger	02-08	268138	10,66€			KN138	18,10€				
400	LT-F 400 Eiger	03-08	268138	10,66€			KN138	18,10€				
400	LT-Z 400 Quadsport	03-19	268139	5,10€			KN139	8,75€				
400	LT400 A/F King Quad	08-15	268138	10,66€			KN138	18,10€				



Cyl	Modèle	Année	EVO	€ T.T.C.	COUVERCLE DE NETTOYAGE	€ T.T.C.	CAGE ALU STANDARD	€ T.T.C.	CAGE ALU EVO	€ T.T.C.
SHERCO										
125	SE 125-R	18-22								
250	SE 2.5i-F 250	09-13								
250	SE-R 250	14-22								
250	SE-R 250 Factory	14-22								
250	SEF-R 2,5 250 4T	14-22								
250	SEF-R 2,5 250 4T Factory	14-22								
250	SX 250 2,5i-F	09-11								
300	SE-R 3,0	13-16								
300	SE-R 3,0 i	12-12								
300	SE-R 300	15-22								
300	SE-R 300 Factory	13-22								
300	SEF-R 300 4T	14-22								
300	SEF-R 300 4T Factory	14-22								
450	Enduro 4.5i 450	04-08								
450	SCF450	19-19								
450	SE 4.5i-F 450	09-11								
450	SE 4.5i-F 450	12-13								
450	SEF-R 450	17-21								
450	SEF-R 450 Factory	16-21								
450	SM 4.5i-F 450	09-13								
450	Supermotard 4.5i 450	05-08								
500	SEF-R 500	20-21								
500	SEF-R 500 Factory	20-21								
510	Enduro 5.1i 510	06-08								
510	SE 5.1i-F 510	09-11								
510	SM 5.1i-F 510	09-13								
510	Supermotard 5.1i 510	07-08								
SUZUKI										
65	RM65	03-06								
80	RM80	86-88								
80	RM80	89-01								
85	RM85	02-22								
90	LT-Z 90	07-13								
110	DRZ110	01-07								
125	DR-Z 125 /L	03-15								
125	DR-Z 125 L	16-22								
125	LT 125 E,H	84-87								
125	RM125	87-95								
125	RM125	96-03								
125	RM125	04-13	267E170500	22,40€	267YZF9603BL	25,00€			26780710	114,00€
160	LT160E Quadrunner	89-92								
160	LT160F Quadsport	91-04								
230	LT230 EH-EP	86-93								
230	LT230 GEF-GEG	85-86								
230	LT230 SF-SJ	85-88								
250	DR-Z 250	01-10								
250	LT-F 250	00-02								
250	LT-F 250 Ozark	02-04								
250	LT-Z 250 Quadsport	04-10								
250	LT250 EFF-EFG (4T)	85-85								
250	LT250 RJ-RR (4temps)	88-88								
250	RM-Z 250	04-06								
250	RM-Z 250	07-17	267E170500	22,40€	267YZF9603BL	25,00€			26780710	114,00€
250	RM-Z 250	18-18	267E170500	22,40€	267YZF9603BL	25,00€			26780710	114,00€
250	RM-Z 250	19-22	267E170180	22,40€	267SUZ0018BL	25,00€				
250	RM250	87-95								
250	RM250	96-02								
250	RM250	03-08	267E170500	22,40€	267YZF9603BL	25,00€			26780710	114,00€
250	RMX250	89-01								
300	LT-F 300 Kingquad	91-11								
400	DR-Z 400 /S	00-09								
400	DR-Z 400 E	00-07								
400	LT-A 400 Eiger	02-08								
400	LT-F 400 Eiger	03-08								
400	LT-Z 400 Quadsport	03-19								
400	LT400 A/F King Quad	08-15								

FILTRATION



Cyl	Modèle	Année	FILTRE À HUILE	€ T.T.C.	FILTRE À AIR MOUSSE	€ T.T.C.	FILTRE À HUILE	€ T.T.C.	DOUBLE MOUSSE	€ T.T.C.	TRIPLE MOUSSE	€ T.T.C.
SUZUKI												
450	LT-A 450 King Quad	08-08	268138	10,66€			KN138	18,10€				
450	LT-R 450 Quadracer	06-14	268139	5,10€			KN139	8,75€				
450	RM-Z 450	05-17	268207	5,65€	267551	12,50€	KN207	10,10€	267170500	20,20€		
450	RM-Z 450	18-22	268207	5,65€			KN207	10,10€	267170180	20,20€		
450	RMX450 Z	10-15	268207	5,65€			KN207	10,10€	267170510	20,20€		
500	LT-A 500 F Quadmaster	00-01	268138	10,66€			KN138	18,10€				
500	LT-A 500 F Vinson	02-10	268138	10,66€			KN138	18,10€				
500	LT-A 500 King Quad	11-15	268138	10,66€			KN138	18,10€				
500	LT-F 500 F Quadranner	98-10	268138	10,66€			KN138	18,10€				
700	LT-A 700 King Quad	05-10	268138	10,66€			KN138	18,10€				
700	LT-V 700 Quadranner	04-10	268204	10,66€			KN204	18,10€				
TM												
85	MX	16-19							267190340	20,20€		
85	MX Junior	16-21							267190340	20,20€		
85	MX Junior >428<	14-15							267190340	20,20€		
125	Cross MX125	98-07							267190420	20,20€		
125	Cross MX125	08-12							267190430	20,20€		
125	Cross MX125	13-22							267190340	20,20€		
125	Enduro 125	98-04							267190420	20,20€		
125	Enduro EN125	05-07							267190420	20,20€		
125	Enduro EN125	08-12							267190430	20,20€		
125	Enduro EN125	13-19							267190340	20,20€		
125	Enduro EN125 FI	20-22							267190340	20,20€		
250	Cross 250 /F	01-06							267190430	20,20€		
250	Cross 250 /F	07-07	268142	10,85€			KN142	12,70€	267190430	20,20€		
250	Cross 250 /F	08-12	268141	6,95€			KN141	11,35€	267190430	20,20€		
250	Cross 250 /F	13-13	268141	6,95€			KN141	11,35€	267190340	20,20€		
250	Cross MX 250 2 temps	14-17	268141	6,95€			KN141	11,35€	267190340	20,20€		
250	Cross MX 250 2 temps	18-22							267190340	20,20€		
250	Cross MX 250 Fi 4 temps	14-17	268141	6,95€			KN141	11,35€	267190360	20,20€		
250	Cross MX 250 Fi 4 temps	18-22							267190360	20,20€		
250	Enduro 250 /F	01-06							267190430	20,20€		
250	Enduro 250 /F	07-07	268142	10,85€			KN142	12,70€	267190430	20,20€		
250	Enduro 250 /F	08-13	268141	6,95€			KN141	11,35€	267190430	20,20€		
250	Enduro EN 250 2 temps	14-22							267190350	20,20€		
250	Enduro EN 250 4 temps	14-17	268141	6,95€			KN141	11,35€	267190350	20,20€		
250	Enduro EN 250 4 temps	18-22							267190350	20,20€		
250	Enduro EN 250 Fi 2 temps	19-22							267190350	20,20€		
300	Cross 300	01-07							267190420	20,20€		
300	Cross 300	08-12							267190430	20,20€		
300	Cross 300	13-13							267190340	20,20€		
300	Cross MX 300 2 temps	14-17	268141	6,95€			KN141	11,35€	267190340	20,20€		
300	Cross MX 300 2 temps	18-22							267190340	20,20€		
300	Enduro 300	01-07							267190420	20,20€		
300	Enduro 300	08-12							267190430	20,20€		
300	Enduro 300	13-13							267190340	20,20€		
300	Enduro EN 300 2 temps	14-22							267190340	20,20€		
300	Enduro EN 300 4 temps	14-22							267190340	20,20€		
300	Enduro EN 300 Fi 2 temps	19-22							267190340	20,20€		
400	Cross 400	02-10							267190430	20,20€		
400	Enduro 400	01-01							267190430	20,20€		
450	Cross 450 F	06-06							267190430	20,20€		
450	Cross 450 F	07-10	268142	10,85€			KN142	12,70€	267190430	20,20€		
450	Cross 450 F	11-12	268141	6,95€			KN141	11,35€	267190430	20,20€		
450	Cross 450 F	13-14	268141	6,95€			KN141	11,35€	267190340	20,20€		
450	Cross 450 F	15-17	268141	6,95€			KN141	11,35€	267190360	20,20€		
450	Cross 450 F	18-22							267190360	20,20€		
450	Enduro 450 F	06-06							267190430	20,20€		
450	Enduro 450 F	07-10	268142	10,85€			KN142	12,70€	267190430	20,20€		
450	Enduro 450 F	11-12	268141	6,95€			KN141	11,35€	267190430	20,20€		
450	Enduro 450 F	13-14	268141	6,95€			KN141	11,35€	267190340	20,20€		
450	Enduro 450 F	15-16	268141	6,95€			KN141	11,35€	267190360	20,20€		
450	Enduro 450 F	17-22							267190360	20,20€		
450	SMR450 F	07-10	268142	10,85€			KN142	12,70€				
450	SMR450 F	11-12	268141	6,95€			KN141	11,35€				
450	SMR450 F	13-14	268141	6,95€			KN141	11,35€	267190340	20,20€		



Cyl	Modèle	Année	EVO	€ T.T.C.	COUVERCLE DE NETTOYAGE	€ T.T.C.	CAGE ALU STANDARD	€ T.T.C.	CAGE ALU EVO	€ T.T.C.
SUZUKI										
450	LT-A 450 King Quad	08-08								
450	LT-R 450 Quadracer	06-14								
450	RM-Z 450	05-17	267E170500	22,40€	267YZF9603BL	25,00€			26780710	114,00€
450	RM-Z 450	18-22	267E170180	22,40€	267SUZ0018BL	25,00€				
450	RMX450 Z	10-15								
500	LT-A 500 F Quadmaster	00-01								
500	LT-A 500 F Vinson	02-10								
500	LT-A 500 King Quad	11-15								
500	LT-F 500 F Quadrunner	98-10								
700	LT-A 700 King Quad	05-10								
700	LT-V 700 Quadrunner	04-10								
TM										
85	MX	16-19	267E190340	22,40€						
85	MX Junior	16-21	267E190340	22,40€						
85	MX Junior >428<	14-15	267E190340	22,40€						
125	Cross MX125	98-07								
125	Cross MX125	08-12								
125	Cross MX125	13-22	267E190340	22,40€						
125	Enduro 125	98-04								
125	Enduro EN125	05-07								
125	Enduro EN125	08-12								
125	Enduro EN125	13-19	267E190340	22,40€						
125	Enduro EN125 FI	20-22	267E190340	22,40€						
250	Cross 250 /F	01-06								
250	Cross 250 /F	07-07								
250	Cross 250 /F	08-12								
250	Cross 250 /F	13-13	267E190340	22,40€						
250	Cross MX 250 2 temps	14-17	267E190340	22,40€						
250	Cross MX 250 2 temps	18-22	267E190340	22,40€						
250	Cross MX 250 Fi 4 temps	14-17	267E190360	22,40€						
250	Cross MX 250 Fi 4 temps	18-22	267E190360	22,40€						
250	Enduro 250 /F	01-06								
250	Enduro 250 /F	07-07								
250	Enduro 250 /F	08-13								
250	Enduro EN 250 2 temps	14-22	267E190350	22,40€						
250	Enduro EN 250 4 temps	14-17	267E190350	22,40€						
250	Enduro EN 250 4 temps	18-22	267E190350	22,40€						
250	Enduro EN 250 Fi 2 temps	19-22	267E190350	22,40€						
300	Cross 300	01-07								
300	Cross 300	08-12								
300	Cross 300	13-13	267E190340	22,40€						
300	Cross MX 300 2 temps	14-17	267E190340	22,40€						
300	Cross MX 300 2 temps	18-22	267E190340	22,40€						
300	Enduro 300	01-07								
300	Enduro 300	08-12								
300	Enduro 300	13-13	267E190340	22,40€						
300	Enduro EN 300 2 temps	14-22	267E190340	22,40€						
300	Enduro EN 300 4 temps	14-22	267E190340	22,40€						
300	Enduro EN 300 Fi 2 temps	19-22	267E190340	22,40€						
400	Cross 400	02-10								
400	Enduro 400	01-01								
450	Cross 450 F	06-06								
450	Cross 450 F	07-10								
450	Cross 450 F	11-12								
450	Cross 450 F	13-14	267E190340	22,40€						
450	Cross 450 F	15-17	267E190360	22,40€						
450	Cross 450 F	18-22	267E190360	22,40€						
450	Enduro 450 F	06-06								
450	Enduro 450 F	07-10								
450	Enduro 450 F	11-12								
450	Enduro 450 F	13-14	267E190340	22,40€						
450	Enduro 450 F	15-16	267E190360	22,40€						
450	Enduro 450 F	17-22	267E190360	22,40€						
450	SMR450 F	07-10								
450	SMR450 F	11-12								
450	SMR450 F	13-14	267E190340	22,40€						

FILTRATION



Cyl	Modèle	Année	FILTRE À HUILE	€ T.T.C.	FILTRE À AIR MOUSSE	€ T.T.C.	FILTRE À HUILE	€ T.T.C.	DOUBLE MOUSSE	€ T.T.C.	TRIPLE MOUSSE	€ T.T.C.
TM												
450	SMR450 F	15-17	268141	6,95€			KN141	11,35€				
450	SMX450 F	07-10	268142	10,85€			KN142	12,70€				
450	SMX450 F	11-12	268141	6,95€			KN141	11,35€				
450	SMX450 F	13-14	268141	6,95€			KN141	11,35€	267190340	20,20€		
530	Cross 530 F	01-01							267190340	20,20€		
530	Cross 530 F	02-06							267190430	20,20€		
530	Cross 530 F	07-10	268142	10,85€			KN142	12,70€	267190430	20,20€		
530	Cross 530 F	11-11	268141	6,95€			KN141	11,35€	267190430	20,20€		
530	Enduro 530 F	01-06							267190430	20,20€		
530	Enduro 530 F	07-10	268142	10,85€			KN142	12,70€	267190430	20,20€		
530	Enduro 530 F	11-12	268141	6,95€			KN141	11,35€	267190430	20,20€		
530	Enduro 530 F	13-14	268141	6,95€			KN141	11,35€	267190340	20,20€		
530	Enduro 530 F	19-21							267190340	20,20€		
530	SMR530 F	07-10	268142	10,85€			KN142	12,70€				
530	SMR530 F	11-12	268141	6,95€			KN141	11,35€				
530	SMR530 F	13-14	268141	6,95€			KN141	11,35€	267190340	20,20€		
530	SMR530 F	15-17	268141	6,95€			KN141	11,35€				
600	SMX600 F	08-09	268141	6,95€			KN141	11,35€				
660	SMX660 F	08-09	268141	6,95€			KN141	11,35€				
YAMAHA												
65	YZ 65	18-22							267180060	20,20€		
85	YZ85 /LW	02-22							267180040	20,20€		
125	YZ125	89-92							267180440	20,20€		
125	YZ125	93-94							267180430	20,20€		
125	YZ125	95-02							267180440	20,20€		
125	YZ125	03-04							267180440	20,20€		
125	YZ125	05-22			267570	12,50€			267180500	20,20€		
225	TT225R	01-01	268143	10,85€			KN143	13,50€				
230	TT230R	05-16	268143	10,85€			KN143	13,50€				
250	TT250 R	87-92	268145	5,90€			KN145	10,00€				
250	TT250 R	93-07	268143	10,85€			KN143	13,50€				
250	WR250	89-97							267180440	20,20€		
250	WR250 F	01-02	268142	10,85€	267570	12,50€	KN142	12,70€	267180500	20,20€		
250	WR250 F	03-08	268141	6,95€	267572	12,50€	KN141	11,35€	267180510	20,20€		
250	WR250 F	09-14	268140	6,95€	267572	12,50€	KN140	10,10€	267180510	20,20€		
250	WR250 F	15-19	268140	6,95€	267568	12,50€	KN140	10,10€	267180140	20,20€		
250	WR250 F	20-22	268140	6,95€	267580	13,50€	KN140	10,10€				
250	XG250 Tricker	05-06	268141	6,95€			KN141	11,35€				
250	YFM250 AN Bruin	05-06	268143	10,85€			KN143	13,50€				
250	YFM250 Bear Tracker	00-05	268143	10,85€			KN143	13,50€				
250	YFM250 R Raptor	08-13	268140	6,95€			KN140	10,10€				
250	YFM250 Timberwolf	95-99	268143	10,85€			KN143	13,50€				
250	YZ250	89-92							267180440	20,20€		
250	YZ250	93-94							267180430	20,20€		
250	YZ250	95-02							267180440	20,20€		
250	YZ250	03-22			267570	12,50€			267180500	20,20€		
250	YZ250 F	01-02	268142	10,85€	267570	12,50€	KN142	12,70€	267180500	20,20€		
250	YZ250 F	03-08	268141	6,95€	267570	12,50€	KN141	11,35€	267180500	20,20€		
250	YZ250 F	09-13	268140	6,95€	267570	12,50€	KN140	10,10€	267180500	20,20€		
250	YZ250 F	14-18	268140	6,95€	267568	12,50€	KN140	10,10€	267180140	20,20€		
250	YZ250 F	19-22	268140	6,95€	267580	13,50€	KN140	10,10€				
250	YZ250 X	16-19			267570	12,50€			267180500	20,20€		
350	TT350	86-97	268143	10,85€			KN143	13,50€				
350	YFM350 Bruin	04-06	268303	10,66€			KN303	18,10€				
350	YFM350 FX Wolverine	95-04	268142	10,85€			KN142	12,70€				
350	YFM350 Grizzly	07-18	268204	10,66€			KN204	18,10€				
350	YFM350 R Raptor	04-16	268142	10,85€			KN142	12,70€				
350	YFM350 X Warrior (Cour.4trous.diam.10.5)	87-88	268142	10,85€			KN142	12,70€				
350	YFM350 X Warrior (Cour.6trous.diam.8.5)	89-04	268142	10,85€			KN142	12,70€				
400	WR400 F	98-01	268142	10,85€			KN142	12,70€	267180440	20,20€		
400	YFM400 FA Kodiak	00-05	268303	10,66€			KN303	18,10€				
400	YFM400 FP Big Bear	03-05	268142	10,85€			KN142	12,70€				
400	YFM400 FW Big Bear Pro	00-03	268142	10,85€			KN142	12,70€				
400	YZ400 F	98-99	268142	10,85€			KN142	12,70€	267180440	20,20€		



Cyl	Modèle	Année	EVO	€ T.T.C.	COUVERCLE DE NETTOYAGE	€ T.T.C.	CAGE ALU STANDARD	€ T.T.C.	CAGE ALU EVO	€ T.T.C.
TM										
450	SMR450 F	15-17								
450	SMX450 F	07-10								
450	SMX450 F	11-12								
450	SMX450 F	13-14	267E190340	22,40€						
530	Cross 530 F	01-01	267E190340	22,40€						
530	Cross 530 F	02-06								
530	Cross 530 F	07-10								
530	Cross 530 F	11-11								
530	Enduro 530 F	01-06								
530	Enduro 530 F	07-10								
530	Enduro 530 F	11-12								
530	Enduro 530 F	13-14	267E190340	22,40€						
530	Enduro 530 F	19-21	267E190340	22,40€						
530	SMR530 F	07-10								
530	SMR530 F	11-12								
530	SMR530 F	13-14	267E190340	22,40€						
530	SMR530 F	15-17								
600	SMX600 F	08-09								
660	SMX660 F	08-09								
YAMAHA										
65	YZ 65	18-22								
85	YZ85 /LW	02-22								
125	YZ125	89-92			267YZF9603BL	25,00€				
125	YZ125	93-94			267YZF9603BL	25,00€				
125	YZ125	95-02			267YZF9603BL	25,00€				
125	YZ125	03-04	267E180500	22,40€	267YZF9603BL	25,00€			26780860	126,00€
125	YZ125	05-22	267E180500	22,40€	267YZF9603BL	25,00€			26780860	126,00€
225	TT225R	01-01								
230	TT230R	05-16								
250	TT250 R	87-92								
250	TT250 R	93-07								
250	WR250	89-97			267YZF9603BL	25,00€				
250	WR250 F	01-02	267E180500	22,40€	267YZF9603BL	25,00€			26780860	126,00€
250	WR250 F	03-08								
250	WR250 F	09-14								
250	WR250 F	15-19	267E180140	22,40€	267YZF0014BL	25,00€			26780940	174,80€
250	WR250 F	20-22	267E180190	20,20€	267YAMFAC19*	25,00€	26780970¹	233,40€	26780960	91,90€
250	XG250 Tricker	05-06								
250	YFM250 AN Bruin	05-06								
250	YFM250 Bear Tracker	00-05								
250	YFM250 R Raptor	08-13								
250	YFM250 Timberwolf	95-99								
250	YZ250	89-92			267YZF9603BL	25,00€				
250	YZ250	93-94			267YZF9603BL	25,00€				
250	YZ250	95-02			267YZF9603BL	25,00€				
250	YZ250	03-22	267E180500	22,40€	267YZF9603BL	25,00€			26780860	126,00€
250	YZ250 F	01-02	267E180500	22,40€	267YZF9603BL	25,00€			26780860	126,00€
250	YZ250 F	03-08	267E180500	22,40€	267YZF9603BL	25,00€			26780860	126,00€
250	YZ250 F	09-13	267E180500	22,40€	267YZF9603BL	25,00€			26780860	126,00€
250	YZ250 F	14-18	267E180140	22,40€	267YZF0014BL	25,00€			26780940	174,80€
250	YZ250 F	19-22	267E180190	20,20€	267YAMFAC19*	25,00€	26780970¹	233,40€	26780960	91,90€
250	YZ250 X	16-19	267E180500	22,40€	267YZF9603BL	25,00€			26780860	126,00€
350	TT350	86-97								
350	YFM350 Bruin	04-06								
350	YFM350 FX Wolverine	95-04								
350	YFM350 Grizzly	07-18								
350	YFM350 R Raptor	04-16								
350	YFM350 X Warrior (Cour.4trous.diam.10.5)	87-88								
350	YFM350 X Warrior (Cour.6trous.diam.8.5)	89-04								
400	WR400 F	98-01			267YZF9603BL	25,00€				
400	YFM400 FA Kodiak	00-05								
400	YFM400 FP Big Bear	03-05								
400	YFM400 FW Big Bear Pro	00-03								
400	YZ400 F	98-99			267YZF9603BL	25,00€				

FILTRATION



Cyl	Modèle	Année	FILTRE À HUILE	€ T.T.C.	FILTRE À AIR MOUSSE	€ T.T.C.	FILTRE À HUILE	€ T.T.C.	DOUBLE MOUSSE	€ T.T.C.	TRIPLE MOUSSE	€ T.T.C.
YAMAHA												
426	WR426 F	01-02	268142	10,85€			KN142	12,70€	267180440	20,20€		
426	YZ426 F	00-02	268142	10,85€			KN142	12,70€	267180440	20,20€		
450	WR450 F	03-08	268141	6,95€	267572	12,50€	KN141	11,35€	267180510	20,20€		
450	WR450 F	09-14	268140	6,95€	267572	12,50€	KN140	10,10€	267180510	20,20€		
450	WR450 F	15-18	268140	6,95€	267568	12,50€	KN140	10,10€	267180140	20,20€		
450	WR450 F	19-22	268140	6,95€	267580	13,50€	KN140	10,10€				
450	YFM450 FA Kodiak	03-06	268303	10,66€			KN303	18,10€				
450	YFM450 FG Grizzly	07-12	268204	10,66€			KN204	18,10€				
450	YFM450 FWB Kodiak	17-19	268303	10,66€			KN303	18,10€				
450	YFM450 FX Wolverine	06-07	268204	10,66€			KN204	18,10€				
450	YFZ450 /S	04-06	268141	6,95€			KN141	11,35€				
450	YFZ450 /S	07-08	268140	6,95€			KN140	10,10€				
450	YFZ450 R	09-18	268140	6,95€			KN140	10,10€				
450	YZ450 F	03-08	268141	6,95€	267570	12,50€	KN141	11,35€	267180500	20,20€		
450	YZ450 F	09-09	268140	6,95€	267570	12,50€	KN140	10,10€	267180500	20,20€		
450	YZ450 F	10-13	268140	6,95€	267567	13,50€	KN140	10,10€	267180100	20,20€		
450	YZ450 F	14-17	268140	6,95€	267568	12,50€	KN140	10,10€	267180140	20,20€		
450	YZ450 F	18-22	268140	6,95€	267580	13,50€	KN140	10,10€				
600	YFM600 FWA	98-01	268145	5,90€			KN145	10,00€				
660	YFM660 Grizzly	02-06	268303	10,66€			KN303	18,10€				
660	YFM660 Grizzly	07-08	268204	10,66€			KN204	18,10€				
660	YFM660 Raptor	01-05	268147	10,66€			KN147	18,25€				
700	YFM700 F Grizzly	07-18	268204	10,66€			KN204	18,10€				
700	YFM700 R Raptor	06-18	268145	5,90€			KN145	10,00€				





Cyl	Modèle	Année	EVO	€ T.T.C.	COUVERCLE DE NETTOYAGE	€ T.T.C.	CAGE ALU STANDARD	€ T.T.C.	CAGE ALU EVO	€ T.T.C.
YAMAHA										
426	WR426 F	01-02			267YZF9603BL	25,00€				
426	YZ426 F	00-02			267YZF9603BL	25,00€				
450	WR450 F	03-08			267YZF9603BL	25,00€				
450	WR450 F	09-14			267YZF9603BL	25,00€				
450	WR450 F	15-18	267E180140	22,40€	267YZF0014BL	25,00€			26780940	174,80€
450	WR450 F	19-22	267E180190	20,20€	267YAMFAC19*	25,00€	26780970 ¹	233,40€	26780960	91,90€
450	YFM450 FA Kodiak	03-06			267YZF9603BL	25,00€				
450	YFM450 FG Grizzly	07-12			267YZF9603BL	25,00€				
450	YFM450 FWB Kodiak	17-19			267YZF9603BL	25,00€				
450	YFM450 FX Wolverine	06-07			267YZF9603BL	25,00€				
450	YFZ450 /S	04-06			267YZF9603BL	25,00€				
450	YFZ450 /S	07-08			267YZF9603BL	25,00€				
450	YFZ450 R	09-18			267YZF9603BL	25,00€				
450	YZ450 F	03-08	267E180500	22,40€	267YZF9603BL	25,00€			26780860	126,00€
450	YZ450 F	09-09	267E180500	22,40€	267YZF9603BL	25,00€			26780860	126,00€
450	YZ450 F	10-13			267YZF0010BL	25,00€			26780930	100,10€
450	YZ450 F	14-17	267E180140	22,40€	267YZF0014BL	25,00€			26780940	174,80€
450	YZ450 F	18-22	267E180190	20,20€	267YAMFAC19*	25,00€	26780970 ¹	233,40€	26780960	91,90€
600	YFM600 FWA	98-01								
660	YFM660 Grizzly	02-06								
660	YFM660 Grizzly	07-08								
660	YFM660 Raptor	01-05								
700	YFM700 F Grizzly	07-18								
700	YFM700 R Raptor	06-18								

¹Kit Air Power



Montage Racing KTM

Les filtres présentés ici ne se montent qu'avec une cage alu 5 pins

Cyl.	Nom véhicule	Années	Cage alu	€ T.T.C.	Filtre à air Triple mousse	€ T.T.C.	Filtre à air Evolution	€ T.T.C.
KTM								
85	SX85	13 - 17	26780910	82,80 €	267KTM030	19,80 €	267EKTMO30	19,80 €
125	EXC125	12 - 16	26780910	82,80 €	267KTM030	19,80 €	267EKTMO30	19,80 €
125	SX125	11 - 15	26780910	82,80 €	267KTM030	19,80 €	267EKTMO30	19,80 €
150	SX150	11 - 15	26780910	82,80 €	267KTM030	19,80 €	267EKTMO30	19,80 €
200	EXC200	12 - 15	26780910	82,80 €	267KTM030	19,80 €	267EKTMO30	19,80 €
250	EXC250	12 - 16	26780910	82,80 €	267KTM030	19,80 €	267EKTMO30	19,80 €
250	EXC250-F	12 - 16	26780910	82,80 €	267KTM030	19,80 €	267EKTMO30	19,80 €
250	SX250-F	11 - 15	26780910	82,80 €	267KTM030	19,80 €	267EKTMO30	19,80 €
300	EXC300	11 - 16	26780910	82,80 €	267KTM030	19,80 €	267EKTMO30	19,80 €
350	EXC350-F	12 - 16	26780910	82,80 €	267KTM030	19,80 €	267EKTMO30	19,80 €
350	SX350-F	11 - 15	26780910	82,80 €	267KTM030	19,80 €	267EKTMO30	19,80 €
450	EXC450	12 - 16	26780910	82,80 €	267KTM030	19,80 €	267EKTMO30	19,80 €
450	SMR450	12 - 14	26780910	82,80 €	267KTM030	19,80 €	267EKTMO30	19,80 €
450	SX450-F	11 - 15	26780910	82,80 €	267KTM030	19,80 €	267EKTMO30	19,80 €
500	EXC500-F	12 - 16	26780910	82,80 €	267KTM030	19,80 €	267EKTMO30	19,80 €



Kit spécifique KTM FREERIDE 250/350

Désignation	Référence	€ T.T.C.
Pour 250 CC - 250 R 14-16 : 1 CAGE / 2 FILTRES / 1 BONNET	267KTM07S	154,80
Pour 350 CC - 250 F 18-20 : 1 CAGE / 2 FILTRES / 1 BONNET	267KTM06S	144,00



Autres produits DT-1

DT-1 produits universels	Référence	€ T.T.C.
FILTRE A AIR CROSS 25 CM x 30 CM not oiled	267FOAMCR010	17,40
DT1 BONNET SANDSTOP, UNIVERSEL	267BONNET01	20,70
DT1 BONNET SANDSTOP YAMAHA YZF 450 (10-13) POUR 267180100	267BONNET02	20,70
DT1 BONNET SANDSTOP UNIVERSEL POUR 60-65-85 CC / YAMAHA YZF 250/450 (14>)	267BONNET03	20,70
DT1 BONNET SANDSTOP POUR KTM FREERIDE 350	267BONNET04	20,70
DT1 BONNET SANDSTOP POUR KTM FREERIDE 250	267BONNET05	20,70
Filtre à air - Diamètre 25 à 29 mm	267PITBIKE28NO	18,60
Filtre à air - Diamètre 34 à 38 mm	267PITBIKE36NO	20,00
Filtre à air - Diamètre 43 à 47 mm	267PITBIKE45NO	20,00
Filtre à air - Diamètre 48 à 52 mm	267PITBIKE50NO	20,00



YAMAHA YZF OEM standard

Cage réf. 26780960 (AIRC-YAM-19) et Filtre 267E180190 (EVO-180-19).

Montage sur la boîte à air d'origine. Remplacement de l'origine avec cage alu pour meilleure étanchéité.



SPÉCIAL

YZ 250 F 2019>
YZ 450 F 2018>
WRF 250 2020>
WRF 450 2019>

YAMAHA YZF special factory parts

Support de cage + cage réf. 26780970 (AIRC-YAMFAC-19), KIT AIR POWER à monter en lieu et place de la grille de protection. Livré avec filtre (DT-YAMFAC-19NO).

Kit d'évolution à monter sur la boîte à air d'origine, filtre bombé = plus grande surface de filtration, meilleure performance.

Étanchéité maximum avec cage et support alu.





ENTRETIEN FILTRE À AIR



DT-1 nettoyant / huiles

	Référence	€ T.T.C.
Nettoyant filtre à air DT-1	267CLEANER	47,70
Huile filtre à air DT-1 Ignifugé Biodegradable	267OLIE	14,80
Huile filtre à air DT-1	267OLIE01	14,20
Kit de nettoyage : seau, graisse et nettoyant filtre à air	267WASHKIT01	60,50
Kit de nettoyage : seau, graisse et nettoyant filtre à air BIO	267WASHKIT02	59,90



Air Filter Oil

Huile filtre à air
Retient la poussière, le sable
et la boue
Séchage rapide

Liquide 50cl - 2800651

17,80 €
T.T.C.

Spray 75cl - 2800652

24,70 €
T.T.C.



Air Filter Cleaner

Nettoyant filtre à air
40 utilisations

5L - 2800683

51,50 €
T.T.C.



Action Kit

Tout ce dont vous avez besoin pour l'entretien du filtre à air en mousse :

- Action Cleaner 4 L
- 1 seau 10 L + grille & couvercle
- Action Fluid 1 L
- 1 seau 3 L + couvercle
- 10 g de graisse céramique
- Gants jetables

70010

85,20 € I.T.C.



Action Cleaner

Dégraissage de haute qualité pour le nettoyage efficace de tous les filtres à air en mousse modernes. Soluble dans l'eau, assure une durée de vie plus longue du moteur et du filtre.

600 ml x 12 - 70004

15,30 € I.T.C.

2 L x 5 - 74484

19,30 € I.T.C.



Action Fluid

L'huile originale de filtre à air en mousse n° 1 mondiale.

Convient aux filtres à air en mousse bicouches de première qualité utilisés pour GP Motocross et FIM Enduro WC.

600 ml x 12 - 70007

15,30 € I.T.C.

1 L x 12 - 70005

18,00 € I.T.C.

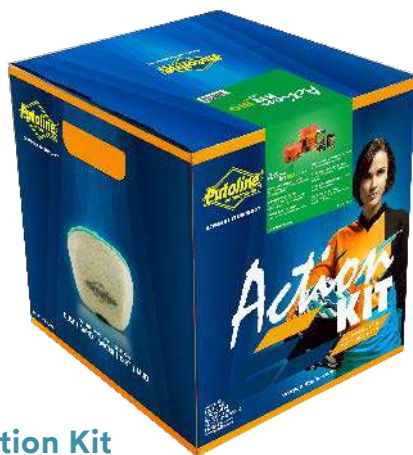

Action Kit Biodegradable

Tout ce dont vous avez besoin pour l'entretien du filtre à air en mousse :

- Action Cleaner Bio 600g
- 1 seau 10 L + couvercle & grille
- Action Fluid Bio 1 L
- 1 seau 3 L + couvercle
- 10 g de graisse céramique
- Gants jetables

70011

91,70 € I.T.C.



Bio Action Cleaner

Dégraissage de haute qualité pour le nettoyage efficace de tous les filtres à air en mousse modernes. Soluble dans l'eau et biodégradable.

Assure une durée de vie plus longue du moteur et du filtre.

600 g x 12 - 74102

19,30 € I.T.C.



Action Fluid Bio

L'huile originale biodégradable de filtre à air en mousse n° 1 mondiale. Convient aux filtres à air en mousse bicouches de première qualité utilisés pour GP Motocross et FIM Enduro WC.

600 ml x 12 - 70031

13,80 € I.T.C.

1 L x 12 - 70030

33,50 € I.T.C.

FILTRATION



MIW Filters



www.miwfilters.com/fr

La filtration depuis 1964

Meiwa et MIW sont des noms bien connus dans l'industrie de la filtration. Issus d'une expérience OEM et produits au Japon depuis 50 ans, ces filtres sont acceptés dans l'industrie de la moto. Aujourd'hui, MIW aborde un nouveau chapitre avec l'introduction d'une gamme plus complète de filtres pour les marchés asiatiques, européens et américains.

Filtres mousse

NOUVEAUTÉ

Retrouvez les filtres à air mousés dans notre guide d'application. Toujours le meilleur rapport qualité prix.



Les références des pros

Que ce soit sur asphalte ou sur terre, les plus grandes marques de la filtration sont chez MORACO : DT-1, K&N et MIW. Toutes ces références sont fabriquées à partir des meilleurs matériaux et surpassent la monte d'origine.





30 ans d'expérience

Choisi par de nombreux professionnels, DT-1 est vendu dans le monde entier. La technologie mousse de DT-1 délivre un débit d'air maximal tout en maintenant la protection du moteur. Le joint de base fournit la meilleure étanchéité du marché. Tous les filtres à air DT-1 sont faits main, fabriqués en Belgique et aux USA avec la plus haute qualité double et triple mousse disponible. Les filtres DT-1 Air sont livrés en standard ou pré-huilés. Les filtres pré-huilés sont huilés à l'huile de filtre bio-dégradable aux propriétés ignifugeantes. Un filtre pré-huilé utilise 50% d'huile en moins et offre un rendement moteur inégalable.



Double mousse

Le filtre à air double mousse DT-1 permet une étanchéité parfaite entre le filtre à air et la boîte à air grâce à sa base spécifique.

Triple mousse évolution

Le filtre à air triple mousse DT-1 permet de délivrer un débit d'air maximal tout en maintenant une protection optimale du moteur.



Double mousse ignifugé pré-huilé

Filtre à air double mousse avec mousse intérieure aux propriétés anti-feu accrues.

Disponible sur demande



Kit Airpower

La cage en aluminium, plus rigide que la cage d'origine en plastique, dispense d'utiliser un écran de retour de flamme lorsqu'elle est utilisée avec l'huile spécifique DT1.



Embase de boîte à air carbone

Guide pour faciliter la mise en place du filtre. Permet une meilleure étanchéité.

Surfiltre simple mousse

Protection supplémentaire pour les conditions extrêmes.



Couvercle de boîte

Le couvercle DT-1 empêche l'eau et la saleté de pénétrer dans la boîte à air lors du nettoyage. Il est moulé pour tenir sur la boîte à air et la bague d'étanchéité crée le joint.





Ride Bold*

**Pilotez avec audace*

Pneus pour toutes les motos. Vee Rubber Group est le leader en Thaïlande, en termes de variété de types de pneus pour véhicules produits, allant du petit karting au grand commercial. VEE Moto, filiale de Vee Rubber Group depuis de longues années, utilise la meilleure ingénierie et les meilleures gommages sur le marché depuis 1977.



VEE RUBBER

PNEUMATIQUES

PNEUMATIQUES /
MOUSSES /
CHAMBRES À AIR /



Cross	416
Enduro	417
Trail / Trial / Mini Pitbike	418
Mousses	420
Chambres à air	422



PNEUMATIQUES

MX / XC / Enduro



FORCE AT

Le pneu AT qui offre un contrôle incroyable dans toutes les conditions. Il s'attaque à la boue, au sable, aux rochers, racines et bûches. Plus besoin de changer de pneus pour différentes conditions de piste.

Sa conception peut gérer l'utilisation de pressions inférieures, d'inserts en mousse ou de systèmes sans chambre à air pour une meilleure traction.

NOUVEAUTÉ



VRM 462 FORCE AT			
Dimensions	Indices	Référence	€ T.T.C.
90/100-21	57M	9121462	70,50€

Homologué Route

VRM 463 FORCE AT			
Dimensions	Indices	Référence	€ T.T.C.
110/100-18	64M	1118463	82,90€
120/100-18	68M	12118463	85,80€

Homologué Route

MX / XC / Enduro



VRM 500
AGGRESSIVE

Dimensions	Indices	Référence	€ T.T.C.
100/100-18	59M TT	1118500	58,20
110/90-19	62M TT	11919500	68,50
110/100-18	64M TT	11118500	65,60
100/90-19	57M TT	1919500	62,40
80/100-21	51M TT	8121500	52,80

Homologué Route

Enduro



VRM 211
Enduro FIM

Dimensions	Indices	Référence	€ T.T.C.
120/90-18	65R TT	12918211	71,10
140/80-18	70R TT	14818211	82,80
90/90-21	54R TT	9921211	56,20

Homologué FIM



VRM 175
Enduro FIM Terrain sec

Dimensions	Indices	Référence	€ T.T.C.
140/80-18	70R TT	14818175	86,10

Homologué FIM

Trail



VRM 122

Dimensions	Indices	Référence	€ T.T.C.
110/80-17	57J TT	11817122	44,20€
110/80-18	62P TT	11818122	63,10€
90/90-19	52J TT	9919122	39,40€
80/90-21	48P TT	8921122	45,90€



VRM 163

Dimensions	Indices	Référence	€ T.T.C.
120/90-16	63P TT	12916163	75,40€
130/80-17	65S TL	13817163	89,70€
4.10-18	59P TT	4118163	70,60€
90/100-19	55P TL	9119163	93,80€
2.75-21	45P TT	27521163	51,20€
90/90-21	54S TL	9921163	72,40€



VRM 193

Dimensions	Indices	Référence	€ T.T.C.
90/90-21	54H TL	9921193	90,40€
130/80-17	65H TL	13817193	116,00€

Trial



VRM 021
Loisir

Dimensions	Indices	Référence	€ T.T.C.
4.00-18	64P TT	418021	70,30
2.75-21	50R TT	27521021	42,90
3.00-18	52P TT	318021	44,50
3.00-14	40R TT	314021	41,90
3.25-18	59R TT	32518021	50,60
2.50-17	43M TT	2517021	27,90
2.75-19	49P TT	27519021	40,90
2.75-17	47P TT	27517021	38,20



VRM 308
Radial - Racing

Dimensions	Indices	Référence	€ T.T.C.
2.50-19	41L TT	2519308	67,20
2.75-21	45L TT	27521308	78,60
3.50-17	54L TL	3517308	109,80
4-18	64L TL	418308	127,00

Mini-pitbike

VRM 140

Dimensions	Indices	Référence	€ T.T.C.
2.50-10	33J TT	251140	23,60
80/100-12	41M TT	8112140	33,60
80/100-14	49M TT	8114140	49,00
90/100-16	51M TT	9116140	61,60
70/100-17	40M TT	7117140	37,50
70/100-19	42M TT	7119140	64,60

VRM 174

Dimensions	Indices	Référence	€ T.T.C.
2.50-10	TT	251174	20,20
2.50-14	TT	2514174	31,00

VRM 270

Dimensions	Indices	Référence	€ T.T.C.
2.50-10	32J TT	251270	22,70
2.50-12	42J TT	2512270	30,10

VRM 271

Dimensions	Indices	Référence	€ T.T.C.
2.75-10	37J TT	2751271	24,30

VRM 272

Dimensions	Indices	Référence	€ T.T.C.
60/100-14	29M TT	6114272	41,00

VRM 273

Dimensions	Indices	Référence	€ T.T.C.
80/100-12	41M TT	8112273	38,20

MORACO

a mandaté ALIAPUR pour collecter les pneus usagés, décret n° 2015-1003 du 18 août 2015. Numéro SYDEREP FR011829_16A5CS

Coût prélevé sur tout pneu vendu : 0,94 € H.T.

Informations au 09 70 24 13 13

MOUSSES



NOUVEAUTÉ

Mousse pour pneu haute qualité.

Longévité accrue. Gel pour installation inclus

Dimensions	Référence	€ T.T.C.
90/100-16 MX NEW	MUP90116	102,20€
70/100-19 MX NEW	MUP70119	99,90€
100/90-19 MX	MUP10919	99,90€
110/90-19 MX	MUP11919	99,90€
80/100-21 MX NEW	MUP80121	89,90€
120/90-18 Enduro	MUP12918	93,40€
140/80-18 Enduro	MUP14818	99,90€
90/90-21 et 80/100-21 Enduro	MUP8121	87,90€
120/90-18 Enduro soft NEW	MUP12918S	104,40€
140/80-18 Enduro soft* NEW	MUP14818S	109,90€
90/90-21 Enduro soft NEW	MUP9921S	99,90€
MUPLUB - Gel pour installation	MUPLUB	5,40€

Enduro classique, randonnée et gamme MX.

Correspondance Pression :
 Mousse enduro 0,8 - 0,9 Bar
 Mousse enduro soft 0,7 Bar
 Mousse MX avant 0,8 - 0,9 Bar
 Mousse MX arrière 1,1 - 1,3 Bar

*Montage compatible pneumatique Michelin medium

FULL CONTACT

NOUVEAUTÉ

Dimensions	Référence	€ T.T.C.
140/80-18 Enduro	MFC81841	115,90€
140/80-18 Enduro soft	MFC81841S	126,40€
90/90-21 - 80/100-21 Enduro	MFC92109	109,90€

**Pression optimale dès le montage, excellent grip pour passages enduro techniques.
Mousse compatible tous pneus enduro**

Pression : 0,7 - 0,8 Bar

MADE IN EUROPE



ENDURO
MOTOCROSS
RALLY
HARD ENDURO

mousse



Anti-crevaison

La mousse de pneu est la solution anti-crevaison pour les activités de Moto Cross, Rallye-Raid et Enduro.

Une technologie exclusive alliant air et mélange de gomme pour une parfaite symbiose pneu / mousse.

La mousse confère plus de maniabilité, plus de grip, une meilleure tenue latérale et une excellente longévité.

Précautions :

- Ne pas stocker à plus de 30°C pendant plus de 30 jours
- Évitez de les exposer à des températures supérieures à 40°C
- Une fois utilisé, la mousse tiendra 6 mois maximum avant de se dégrader
- Ne pas utiliser sur route publique (NHS)
- Ne pas rouler à plus de 130 km/h

CHAMBRES À AIR



Type de valve

Les chambres à air sont livrées avec bouchon et écrou de valve.

Droite : TR4 standard / Coudée : PV78 - TR87 / Double renforcée : TR4 - HEAVY / Épaisseur 5 mm : TR4 - SUPER HEAVY DUTY



TR4

TR87

PV78

Standard

Dimensions	Référence	Valve	€ T.T.C.
350/400-8	35484	TR4	7,60
250/275-10	2514	TR4	5,90
250/275-10	25187	JS87	6,40
100/80-10	18187	TR87	7,10
100/90-10	19187	JS87	6,70
300/350-10	335187	JS87	6,70
250-12	25124	TR4	6,60
275/300-12	275124	TR4	7,10
275/300-12	2751287	JS87	7,30
350/400-13	3541387	JS87	7,20
250/275-14	25275144	TR4	7,00
60/100-14	61144	TR4	5,00
275/300-14	2753144	TR4	7,40
3.50/4.10-14	41144	TR4	7,50
180/80-14	188144	TR4	17,90
130/90-15	139154	TR4	10,30
130/90-15	1391578	PV78	11,70
4.50/5.10-15	4551154	TR4	10,30
2-2 1/2-16-17	221216174	TR4	5,90
2 1/4-16	214164	TR4	5,90
2 3/4-16	234164	TR4	6,90
90/90-16	99164	TR4	7,60
120/80-16	128164	TR4	7,90

Dimensions	Référence	Valve	€ T.T.C.
120/80-16	1281678	PV78	9,50
110/90-16	119164	TR4	7,90
300/325-16, 90/100-16	3325164	TR4	7,60
325/350-16	32535164	TR4	7,90
450/510-16	4551164	TR4	11,30
250-17 - 70/100-17	71174	TR4	13,50
275/300-17	2753174	TR4	7,50
100/80-17	18174	TR4	7,50
130/70-17	137174	TR4	8,30
60/100-17	611713	TR13	5,70
350/400-17	354174	TR4	9,20
4.50/5.10-17	4551174	TR4	11,40
2.75/3.00-18	2753184	TR4	7,10
3.00/3.25-18	325184	TR4	8,00
350-18 TR4	25184	TR4	6,80
325/350-18	32535184	TR4	8,50
350/400-140/80-18	148184	TR4	9,00
400/450/475-18	445184	TR4	10,60
500/550-18	555184	TR4	12,50
225/250-70/100-19	22525194	TR4	6,80
300/325-90/90-19	3325194	TR4	8,20
110-120/90-19	11129194	TR4	10,70
275/300-21	2753214	TR4	8,30

Heavy - Super Heavy Duty

Dimensions	Référence	Valve	€ T.T.C.
80/100-12 HEAVY	81124H	TR4	12,80
80/100-14 HEAVY	81144H	TR4	13,50
90/100-16 HEAVY	91164H	TR4	14,50
70/100-17 HEAVY	71174H	TR4	13,50
100/100-18	11184	TR4	17,10
100/100-18 SUPER HEAVY	11184S	TR4	26,80
110/100-18	111184	TR4	17,10
110/100-18 SUPER HEAVY	111184S	TR4	28,40

Dimensions	Référence	Valve	€ T.T.C.
120/100-18	121184	TR4	19,30
70/100-19	711194	TR4	12,70
100/90-19	19194	TR4	16,50
110/90-19	119194	TR4	19,30
110/90-19 SUPER HEAVY	119194S	TR4	28,70
120/90-19	129194	TR4	19,30
80/100-21	81214	TR4	16,50
80/100-21 SUPER HEAVY	81214S	TR4	26,20

Fond de jante

Dimensions	Référence	€ T.T.C.
250-15 - 5 x 112 cm	FJ15	3,70
225/300-16 - 5 x 118 cm	FJ16	3,70
450/550-17 - 5 x 120 cm	FJ17	3,70
350/450-18	FJ18	3,70
275/325-21	FJ21	3,70



Gripster



Dimensions	Référence	€ T.T.C.
1.40' / 1.60'	RFERMACOP160	21,95
1.85'	RFERMACOP185	21,95
2.15'	RFERMACOP215	21,95
2.5'	RFERMACOP250	21,95



Aide au (dé)montage



NOUVEAUTÉ

Tyre Fitting Lube

Aérosol de première qualité pour (dé)monter les pneus de moto.

Évite que le pneu se déchire et se détache



500ml - 74221

13,90 €
I.T.C.



Driven by technology

Gamme professionnelle complète

Putoline Oil fournit une large gamme de lubrifiants et de produits d'entretien de haute qualité. Nos années d'expérience et nos efforts de recherche continus vous garantissent le meilleur rapport qualité/prix. La fabrication de nos propres produits assure une qualité élevée et constante.

+ PRODUITS 100% MOTO

Nous sommes spécialisés dans les produits destinés aux motos et cela nous rend unique.

+ CONSEILS PRODUIT

Notre base de données en ligne est la plus consultée. Putoline Oil donne des conseils de lubrification pour tout type de moto.

+ PROFESSIONNEL

Le service, la gamme, les recommandations faits par des professionnels pour des professionnels ainsi que pour les motards.

+ PROMOTION

Nous parrainons des événements route et off road de dimension nationale et internationale.

+ PRODUCTEUR

Nos produits sont innovants, livrés rapidement et surtout **FABRIQUÉS EXCLUSIVEMENT EN HOLLANDE** dans nos usines de production.



LUBRIFIANTS



LUBRIFIANTS / ENTRETIEN /



PUTOLINE	426
IPONE	442
WD40	450
KYB	453
GS27	454

GAMME PUTOLINE



Huiles **4T OFFROAD**



N-TECH® Pro R+

100% synthèse.

Avec additifs N-TECH® révolutionnaires pour une très faible usure.

Bonnes facultés de nettoyage et compatibilité optimale avec les embrayages à huile.

SPECIFICATIONS :

API SN, JASO MA2



Ester Tech 4+

100% synthèse.

Avec les additifs Ester Tech. Protection sans précédent contre l'usure, performance maximale et compatibilité optimale avec embrayage à huile.

SPECIFICATIONS :

API SM, JASO MA2



Off Road 4

Semi-synthèse.

Avec additif Pure Bike Technomoto. Compatible avec les matériaux de friction d'embrayage moderne. Créée pour les motos tout-terrain.

SPECIFICATIONS :

JASO MA2, API SM

Viscosité	Conditionnement	Référence	€ T.T.C.
10W-40	1 L x 12	74352	22,30 €
	4 L x 4	74353	81,10 €
10W-50	1 L x 12	74358	22,30 €
	4 L x 4	74359	81,10 €
10W-60	1 L x 12	74371	22,30 €
	4 L x 4	74372	81,10 €

Viscosité	Conditionnement	Référence	€ T.T.C.
10W-40	1 L x 12	70634	20,20 €
10W-50	1 L x 12	70636	20,20 €
10W-60	1 L x 12	70638	20,20 €
10W-60	20 L bib	74262	295,60 €

Viscosité	Conditionnement	Référence	€ T.T.C.
10W-40	1 L x 12	70194	18,40 €
10W-40	4 L x 4	70392	67,60 €

HUILES MOTEUR

Huiles **4T OFFROAD**



S4

Minérale.
Plinement compatible avec un matériau de friction d'embrayage moderne. Développée spécialement pour les motos de sport et de tourisme.

SPECIFICATIONS :

API SG, JASO MA



Ester Tech Quad RF4+

100% synthèse.

Avec additifs Ester Tech. Protection sans précédent contre l'usure, performance maximale et compatibilité optimale avec embrayages à bain d'huile.

SPECIFICATIONS :

JASO MA2, API SM



Castor R

Castor R est une huile de ricin pure de la plus haute qualité, combinée à des additifs spéciaux. Ce produit spécial est destiné aux motos 2 et 4 temps de compétition Grass Track et Speedway. Castor R peut être mélangée avec du méthanol, du nitrométhane et de l'essence.



Viscosité	Conditionnement	Référence	€ T.T.C.
	1 L x 12	74098	15,80 €
10W-40	4 L x 4	74099	63,70 €
	60 L	74191	Nous consulter*

Viscosité	Conditionnement	Référence	€ T.T.C.
10W-40	1 L x 12	70307	20,20 €

Viscosité	Conditionnement	Référence	€ T.T.C.
10W-40	1 L x 12	74165	21,30 €



Qu'est-ce qui rend la technologie additive N-TECH® supérieure ?

- Détruit les résidus de combustion
- Indice de viscosité élevé, pour un fonctionnement à haute température.
- Gains de puissance grâce à ses propriétés à faible frottement.
- Excellentes propriétés à basse température
- Durée de vie du moteur accrue
- Réduction des coûts de maintenance.

HUILES MOTEUR

Huiles **2T OFFROAD**



MX 9

100 % synthétique avec additifs Ester Tech qui protègent très bien contre l'usure. Peu de dépôts de carbone, la performance reste optimale.

SPECIFICATIONS :

API TC, JASO FD, ISO-L-EGD, Husqvarna

1 L x 12 - 70695

26,20 €
I.I.C.

20 L bib - 74269

415,80 €
I.I.C.



MX 7

100 % synthétique pour moteur de course 2 temps, prémélange/injection, avec additifs MHR qui protègent efficacement contre l'usure. Peu de dépôts de carbone pour une performance optimale.

SPECIFICATIONS :

API TC, JASO FD, Husqvarna

1 L x 12 - 70275

24,30 €
I.I.C.



MX 5

Synthétique pour moteur de course 2 temps, prémélange/injection, avec additifs MHR qui protègent contre l'usure. Peu de dépôts de carbone, donc la performance reste optimale.

SPECIFICATIONS :

API TC, JASO FD

1 L x 12 - 70272

17,40 €
I.I.C.

4 L x 4 - 70274

70,70 €
I.I.C.

20 L bib - 74271

300,80 €
I.I.C.



TT Trial Pro Scented

100 % synthétique : Réduit la consommation de carburant. Pas de dépôts sur les segments de piston et le système d'échappement

SPECIFICATIONS :

API TC, JASO FD, TISI

1 L x 12 - 70494

18,00 €
I.I.C.



S2

Huile semi-synthétique. Avec prémélange ou lubrification automatique. Proportion de 2-4 %.

SPECIFICATIONS :

API TC, JASO FD, ISO-L-EGD

1 L x 12 - 74096

12,90 €
I.I.C.

20 L bib - 74306

225,40 €
I.I.C.



RS 959

100 % synthétique : Avec des additifs Ester Tech révolutionnaires.

Adaptée pour moteurs 2 temps qui fonctionnent dans des conditions de course difficiles. Proportion recommandée : 2-4 %.

SPECIFICATIONS :

API TC, JASO FD, TISI

1 L x 12 - 70319

22,30 €
I.I.C.



DRIVEN BY TECHNOLOGY

WORLD CLASS RIDERS USE WORLD CLASS OILS



BE CONNECTED

W WWW.PUTOLINE.COM

f FACEBOOK.COM/PUTOLINE

t TWITTER.COM/PUTOLINE

Transmission



N-TECH® Trans GP

Huile de boîte de vitesses entièrement synthétique avec additifs N-TECH® pour les moteurs 2 et 4 temps. Réduit l'usure de l'embrayage et espace les vidanges.

SPECIFICATIONS :

API GL-1, GL-2, GL-3

1 L x 12 - 73608

22,30 €
I.T.C.



SP Gear Oil 75W-90

Haute qualité, 100% synthèse pour motos, scooters, quads, sur route et tout-terrain.

SPECIFICATIONS :

API GL-4/5

1 L x 12 - 70309

21,90 €
I.T.C.

20 L bib - 74302

354,90 €
I.T.C.

60 L - 74113

Nous consulter*



Light Gear 75W

Passage de vitesse souple, bonne compatibilité d'embrayage et longue durée de service dans des conditions difficiles.

SPECIFICATIONS :

API GL-1

1 L x 12 - 70154

14,00 €
I.T.C.



Medium Gear 80W

Passage de vitesse souple, bonne compatibilité d'embrayage et longue durée de service dans des conditions difficiles.

SPECIFICATIONS :

API GL-1

1 L x 12 - 70158

14,80 €
I.T.C.



Heavy Gear 80W-90

Avec additifs EP (pressions extrêmes). Pour les transmissions à joint universel.

SPECIFICATIONS :

API GL-5, MIL-L-2105D

1 L x 12 - 70148

16,60 €
I.T.C.

20 L bib - 74297

344,90 €
I.T.C.

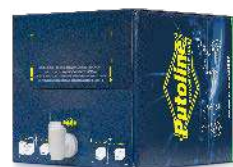

Heavy Gear Extra 85W-140

Avec additifs EP (pressions extrêmes). Pour les transmissions à joint universel.

SPECIFICATIONS :

API GL-5

20 L bib - 74298

308,20 €
I.T.C.



GP 10 75W

Réduction significative de la friction et de la génération de chaleur pour une puissance maximale délivrée à la roue arrière. Créée pour une utilisation sur circuit et pour les motos de route.

SPECIFICATIONS :

API GL-4

1 L x 12 - 70162

13,60 € I.T.C.

20 L bib - 74273

303,40 € I.T.C.



ATF

Réduction de friction, haute stabilité thermique.

Convient aux boîtes de vitesses 2T automatiques et synchronisées, transmissions assistées, convertisseurs de couple, systèmes d'asservissement et embrayages hydrauliques

SPECIFICATIONS :

GM Dexron IID/IIIE/IIIF/IIIG/IIIH

1 L x 12 - 70021

16,20 € I.T.C.

20 L - 74427

286,80 € I.T.C.

60 L - 70023

Nous consulter*

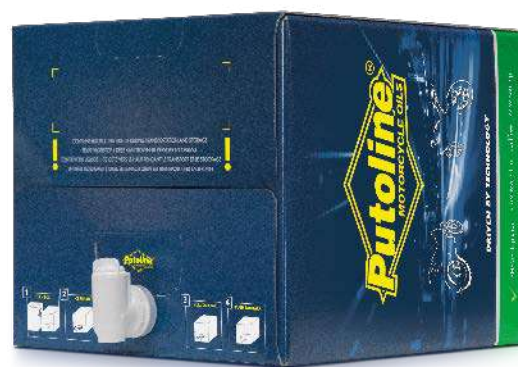

BAG-IN-BOX Bib 20 L

- Packaging recyclable
- Logistique facilitée
- Gaspillage réduit
- Versement aisé
- Sans déversement.

Huiles de fourche et amortisseur



HPX R

Huile de fourche synthétique de haute qualité avec additifs de pointe. Évite corrosion, oxydation, fuites des joints et moussage. Pour motos de route convient à la compétition.



Formula GP

Huile de fourche de première qualité avec des additifs modernes.

Viscosité stable, réduit la friction. Convient à la compétition.



Light Fork

Huile de fourche minérale SAE 5 pour une utilisation sur route normale.

Viscosité	Cond.	Référence	€ T.T.C.
2.5W	1 L x 12	70219	18,00 €
	20 L bib	74276	337,20 €
4W	1 L x 12	74167	18,30 €
	20 L bib	74277	331,80 €
5W	1 L x 12	70226	18,30 €
	20 L bib	74278	332,70 €
7.5W	1 L x 12	70231	17,70 €
	60 L	70543	Nous consulter*
10W	1 L x 12	70212	17,70 €
	20 L bib	74280	341,90 €
15W	1 L x 12	70216	8,00 €
	20 L bib	74281	337,10 €
20W	1 L x 12	70222	17,70 €

5W 1 L - 70139

39,90 €
I.T.C.

10W 1 L - 70135

32,20 €
I.T.C.

500 ml x 12 - 74050

10,20 €
I.T.C.



Medium Fork

Huile de fourche minérale SAE 10 pour une utilisation sur route normale.



Heavy Fork

Huile de fourche minérale SAE 20 pour une utilisation sur route normale.

500 ml x 12 - 74051

10,20 €
I.T.C.

20 L bib - 74301

285,90 €
I.T.C.

500 ml x 12 - 74049

10,20 €
I.T.C.

Huile d'amortisseur



GPR 6 2.5W

Créée pour la compétition. Réduit la friction. Neutralise la formation de mousse. Viscosité très stable.

1 L x 12 - 70177

40,56 €
I.T.C.

20 L bib - 74283

603,50 €
I.T.C.

HUILES FOURCHE / AMORTISSEUR

Lubrifiants chaîne



Chain Wax

Lubrification optimale, résiste à la corrosion et assure une longue durée de vie à la chaîne et aux pignons.

1 kg x 5 - 70051

42,30 €
I.T.C.



Tech Chain

Graisse à base de cire céramique et de PTFE. Protection optimale contre l'usure des chaînes à joints toriques O/X/Z et des pignons dans toutes les conditions de conduite

500 ml x 12 - 70367

24,30 €
I.T.C.



O/X-Ring

100% synthèse. Hydrofuge, fournit une protection optimale contre la corrosion et l'usure.

Pour chaînes à joints toriques et en O/X/Z.

500 ml x 12 - 70289

14,60 €
I.T.C.



DX 11

100% synthèse. Hydrofuge, fournit une protection optimale contre la corrosion et l'usure.

Pour chaînes ouvertes, à joints toriques et en O/X/Z.

500 ml x 12 - 70082

14,60 €
I.T.C.



Drytec Race

PTFE, pénètre bien dans la chaîne. Laisse une couche protectrice transparente et non collante pour que la saleté et le sel ne puissent pas adhérer à la chaîne.

500 ml x 12 - 74086

14,00 €
I.T.C.

LUBRIFIANTS CHAÎNE

Liquides de frein

DOT 4



Liquide de frein synthétique haute performance. Aussi pour motos avec ABS/antipatinage. Peut être mélangé à des liquides DOT 3 et 5.1.

SPECIFICATIONS :

FMVSS 116 DOT 4, SAE J1703, ISO 4925

500 ml x 12 - 74040

14,80 €
I.T.C.

1 L x 12 - 70037

16,50 €
I.T.C.

20 L - 74285

318,50 €
I.T.C.

Ultimate Racing



Liquide de frein synthétique haute performance. Pour motos de course avec ABS/antipatinage. Peut être mélangé à des liquides DOT 3, 4 et 5.1.

SPECIFICATIONS :

FMVSS 116 DOT 4, SAE J1703/J1704

500 ml x 12 - 74041

21,40 €
I.T.C.

DOT 5.1



Liquide de frein synthétique haute performance. Surtout pour motos avec ABS/antipatinage. Peut être mélangé à des liquides DOT 3 et 4.

SPECIFICATIONS :

FMVSS 116 DOT 5.1, SAE J1703, ISO 4925

500 ml x 12 - 74043

15,90 €
I.T.C.

DOT 5 SILICONE



Pour systèmes exigeant un liquide de frein silicone. Plage de températures de -40 à +260 °C.

Ne pas mélanger à un liquide de frein DOT 3, 4 ou 5.1.

SPECIFICATIONS :

FMVSS 116 DOT 5, MIL-B-46176

500 ml x 12 - 74042

39,40 €
I.T.C.

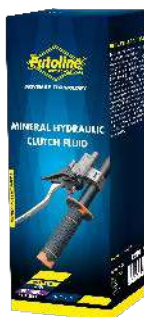

Hydraulic Clutch Fluid

LIQUIDE D'EMBRAYAGE

spécial convenant entre autres aux systèmes d'embrayage Magura, qui nécessitent spécifiquement une huile minérale.

125 ml x 12 - 74209

8,90 €
I.T.C.

Liquides de refroidissement



Coolant NF

Organique, prêt à l'usage. Résiste au gel jusqu'à -38°C. Additifs spéciaux protégeant de la corrosion les métaux souvent présents dans les moteurs et systèmes de refroidissement.



Ice Cooler

Longue durée, biodégradable et prêt à l'emploi. Protège jusqu'à -26°C. Empêche la surchauffe du moteur et réduit considérablement la température de fonctionnement.



Ultracool 12

Longue durée haut de gamme prêt à l'emploi. Protection antigel jusqu'à -40°C. Pour les systèmes de refroidissement en métaux légers : aluminium, magnésium.

Conditionnement	Référence	€ T.T.C.
1 L x 12	70055	10,00 €
4 L x 4	70057	40,70 €
20 L bib	74288	174,50 €
60 L	70058	Nous consulter*
200 L	70250	Nous consulter*

2 L x 5 - 73607

28,20 €
T.T.C.

1 L x 12 - 74130

20 L bib - 74289

10,50 €
T.T.C.

169,90 €
T.T.C.

Putoline Oil

Spécialistes huiles et lubrifiants, nous couvrons tous les besoins de vos clients et de leurs motos



LIQUIDES DE REFROIDISSEMENT

Lubrifiants filtre à air



Action Kit

Tout ce dont vous avez besoin pour l'entretien du filtre à air en mousse :

- Action Cleaner 4 L
- 1 seau 10 L + grille & couvercle
- Action Fluid 1 L
- 1 seau 3 L + couvercle
- 10 g de graisse céramique
- Gants jetables

70010

85,20 € T.T.C.

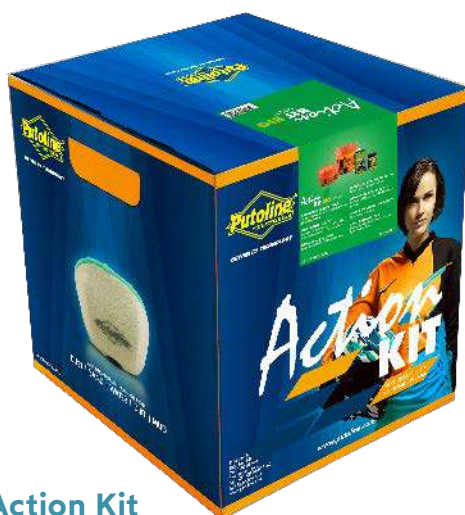

Action Kit Biodegradable

Tout ce dont vous avez besoin pour l'entretien du filtre à air en mousse :

- Action Cleaner Bio 600g
- 1 seau 10 L + couvercle & grille
- Action Fluid Bio 1 L
- 1 seau 3 L + couvercle
- 10 g de graisse céramique
- Gants jetables

70011

91,70 € T.T.C.



Action Cleaner

Dégraissage de haute qualité pour le nettoyage efficace de tous les filtres à air en mousse modernes. Soluble dans l'eau, assure une durée de vie plus longue du moteur et du filtre.

600 ml x 12 - 70004

15,30 € T.T.C.

2 L x 5 - 74484

19,30 € T.T.C.



Action Fluid

L'huile originale de filtre à air en mousse n° 1 mondiale.

Convient aux filtres à air en mousse bicouches de première qualité utilisés pour GP Motocross et FIM Enduro WC.

600 ml x 12 - 70007

15,30 € T.T.C.

1 L x 12 - 70005

18,00 € T.T.C.



Bio Action Cleaner

Dégraissage de haute qualité pour le nettoyage efficace de tous les filtres à air en mousse modernes. Soluble dans l'eau et biodégradable.

Assure une durée de vie plus longue du moteur et du filtre.

600 g x 12 - 74102

19,30 € T.T.C.



Action Fluid Bio

L'huile originale biodégradable de filtre à air en mousse n° 1 mondiale. Convient aux filtres à air en mousse bicouches de première qualité utilisés pour GP Motocross et FIM Enduro WC.

600 ml x 12 - 70031

13,80 € T.T.C.

1 L x 12 - 70030

33,50 € T.T.C.

Additifs carburant



E10 Fuel Fighter

Protège le circuit d'alimentation contre les effets nocifs des carburants E10.

- Anti-corrosion
- Meilleures lubrification
- Réduit les frottements et la consommation de carburant
- Nettoie les injecteurs et les soupapes

250 ml x 12 - 74223

14,70 €
I.T.C.



Octane Booster

Augmente les indices d'octane de l'essence. Réduit le risque de dégâts moteur dûs aux cliquetis : dépose une couche protectrice sur les sièges de soupape pour allonger leur durée de vie et réduire les chocs. Sans danger pour les catalyseurs et les moteurs modifiés.

150 ml x 12 - 74451

9,30 €
I.T.C.



Nettoyant injecteurs et soupapes

Nettoie tout le système d'injection, les soupapes et les chambres de combustion ; ce qui préserve les performances du moteur.

150 ml x 12 - 74452

9,30 €
I.T.C.



Stabilisateur essence

Protège des effets nocifs des carburants E10 pendant les périodes de remisage. Aide au démarrage après une immobilisation prolongée. Anti-corrosion. Convient pour les catalyseurs.

150 ml x 12 - 74453

9,30 €
I.T.C.



Graisses



Racing

Graisse complexe au lithium de très haute qualité EP2. Excellente stabilité mécanique et structure fine qui fait que l'huile n'est pas séparée. Résiste à l'eau.

SPECIFICATIONS :

N.L.G.I. Class 2, DIN 51825, KP2N-30

100 g x 12 - 74114

9,40 €
I.T.C.

600 g x 6 - 73610

22,20 €
I.T.C.

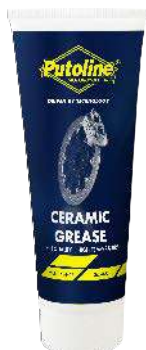

Ceramic

Pâte d'assemblage haut de gamme et graisse lubrifiante pour hautes températures. Plage de températures élevées jusqu'à 1500°C. Haute résistance à la pression. Sans métaux lourds.

SPECIFICATIONS :

N.L.G.I. Class 2,5, DIN 51825, KP2,5N-30

100 g x 12 - 74115

11,50 €
I.T.C.



White Action + PTFE

Graisse au lithium et de première qualité avec PTFE pour une excellente lubrification et peu de friction.

SPECIFICATIONS :

N.L.G.I. Class 2, DIN 51502, KP 2 N-25

100 g x 12 - 74116

8,40 €
I.T.C.

Lubrifiants



1001 Penetrating + PTFE

Lubrifiant multifonction. Lubrifie, chasse l'humidité, a un effet hydrofuge et protège tous les métaux contre la corrosion. Pour motos, scooters, tondeuses et de nombreuses autres utilisations.

500 ml x 12 - 70713

13,30 €
I.T.C.



Tyre Fitting

Aérosol de première qualité pour (dé)monter les pneus de moto.

Évite que le pneu se déchire et se détache.

500 ml x 12 - 74221

13,90 €
I.T.C.

Entretien et nettoyeurs



Chain & Engine Degreaser

Dégraissant spécial puissant, pouvant être rincé à l'eau.

Ôte efficacement huiles et graisses. Convient au chrome, à la peinture, aux pièces en caoutchouc et en plastique.

Non biodégradable.

500 ml x 12 - 70049

14,70 €
I.T.C.



Brake Cleaner

Nettoyant puissant à action rapide, pour nettoyer et dégraisser toutes les pièces des freins : maître-cylindres, étriers et disques.

Sèche proprement et ne laisse pas de résidus de graisse.

500 ml x 12 - 70034

7,90 €
I.T.C.



Contact Cleaner

Spray puissant spécialement préparé pour le nettoyage des bougies, des rupteurs et autres composants électriques. Un additif spécial empêche la corrosion.

500 ml x 12 - 70054

9,60 €
I.T.C.



Carb Cleaner

Nettoyant puissant pour l'ensemble du système de carburant/injection.

Retire l'encrassement nuisible du système de carburant.

Assure un fonctionnement stable du moteur.

Réduit la consommation de carburant.

500 ml x 12 - 70047

14,60 €
I.T.C.



Helmet Sanitizer

Nettoyant hygiénique et moussant pour casque.

Nettoie et neutralise les odeurs désagréables dans la doublure du casque.

Convient également pour nettoyer la coque du casque et la visière.

500 ml x 12 - 74085

11,30 €
I.T.C.



Silicone Spray

Produit de protection et de nettoyage haut de gamme. Le meilleur choix pour protéger correctement les composants électriques contre l'infiltration de l'humidité.

500 ml x 12 - 70334

12,70 €
I.T.C.

Entretien et nettoyeurs



RS1 Bike Wash Pro

Nettoyant biodégradable à action rapide. Protège contre la corrosion.

N'abîme pas le caoutchouc et le plastique.

Laisse un éclat éblouissant. Ne pas utiliser sous des rayons solaires puissants.

1 L x 6 - 74148

15,10 €
I.T.C.



Dirt Bike Super Cleaner Pro

Nettoyant hautement concentré, non toxique, biodégradable pour les motos Motocross et Enduro. Ne laisse pas de taches sur l'aluminium. N'abîme pas le caoutchouc et le plastique.

1 L x 6 - 74149

11,30 €
I.T.C.



Put Off Concentrated

Nettoyant puissant à usage multiple pour motos, quads, scooters, etc. Formule concentrée avec des composants Nano Tech. N'affecte pas le magnésium, les composants anodisés, l'aluminium, etc.

1 L x 6 - 74213

9,30 €
I.T.C.

5 L - 73606

36,50 €
I.T.C.



Matt Wax

Cire de nettoyage haut de gamme à base aqueuse. Adéquate pour être appliquée sur une peinture mate, du métal, de l'aluminium, du titane, du carbone et du plastique. Parfum de vanille.

500 ml x 12 - 74193

13,30 €
I.T.C.



RS1 Wax Polish Spray

Produit nettoyant à la cire de carnauba. Crée une couche protectrice longue durée, avec un éclat profond, sur toutes les surfaces peintes. N'abîme pas le caoutchouc et le plastique.

500 ml x 12 - 70315

19,50 €
I.T.C.



Degreaser RL

Dégraissant minéral.

Élimine huiles, graisses, saletés. Non agressif.

Rincez à l'eau

L'eau de rinçage doit passer par un séparateur d'huile.

20 L bib - 74290

223,70 €
I.T.C.

60 L - 70070

Nous consulter*

Nettoyants



Hand Cleaner Yellow

Savon pour les mains super efficace. N'est pas dangereux et n'irrite pas la peau. Bien rincer à l'eau chaude ou froide ou essuyer avec un chiffon. Ranger dans un endroit frais à l'abri du gel.

4,5 L x 4 - 74117

49,60 €
I.T.C.



Distributeur

Pour savon liquide.
Contenance : 4 L

Distributeur - 74212

139,00 €
I.T.C.



Hand Cleaner Starter

Distributeur de savon et 2 x 4 L de hand cleaner white

Distrib. + 4Lx2 - 74238

204,60 €
I.T.C.



Hand Cleaner White

Recharge pour distributeur 74212

Très bon savon pour les mains sans solvant. Testé dermatologiquement et non irritant. Bien rincer à l'eau. Ranger dans un endroit frais à l'abri du gel.

Recharge 4 L - 74237

41,30 €
I.T.C.



Hand Cleaner Yellow

Recharge pour distributeur 74212

Savon pour les mains super efficace. N'est pas dangereux et n'irrite pas la peau. Bien rincer à l'eau. Ranger dans un endroit frais à l'abri du gel.

Recharge 4 L - 74202

41,30 €
I.T.C.

GAMME IPONE



IPONE, fournisseur exclusif



Créée en 1985, plus de 50 distributeurs sur les 5 continents, plus de 1500 revendeurs en France, plus de 300 références produits.

Red Bull MotoGP Rookies Cup

IPONE et Red Bull s'associent au sein de la Red Bull MotoGP Rookies



CuTremplin d'accès aux Grands Prix moto pour les jeunes talents. IPONE développe les produits de sa gamme racing pour les 24 KTM RC 250 R de la Rookies Cup.

Championnat MXGP

IPONE et le MXGP, c'est l'engagement autour de passions



et de valeurs communes, que le motocross véhicule : dépassement de soi, excellence et partage d'émotions. IPONE est le partenaire exclusif de lubrifiants et de produits d'entretien du championnat MXGP.

Qualité des bases

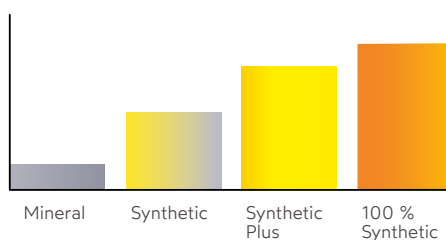

Norme JASO 4T

Elle mesure le niveau de friction.



JASO MA2, haut niveau de friction : évite le patinage, fonctionnement optimal embrayage et boîte de vitesse.



JASO MB, bas niveau de friction : réduction de la conso. d'essence pour les scooters avec un embrayage à sec.

Norme API 4T

Elle mesure la propreté du moteur, la résistance à l'oxydation et la protection contre l'usure.



Norme JASO 2T

Elle mesure le pouvoir lubrifiant, la propreté du moteur et la réduction des émissions de fumée



VENTE À L'UNITÉ
 Livraison J+1

Huiles



Stroke 4

Huile très haute performance, étudiée et testée pour répondre à de très fortes sollicitations tout en augmentant la puissance de la moto.

Les résultats sont spectaculaires :

- + 3% de couple
- - 15% de frictions
- + 2% de performance

RACING

Viscosité	Conditionnement	Référence	Unitaire T.T.C.
5W40	1 L x 15	2800004	25,70 €
5W40	4 L x 6	2800005	90,50 €



Off Road Katana

100% synthèse à base d'esters, très haute performance, pour motos 4 temps, destiné à une conduite sportive sur route.

Normes : JASO MA2 – API SN

SPORTS

Viscosité	Conditionnement	Référence	Unitaire T.T.C.
10W60	1 L x 15	2800019	24,75 €
10W60	2 L x 8	2800364	48,05 €
10W60	4 L x 6	2800020	91,90 €



10.4

Semi-synthèse, pour motos 4 temps, qui assure une lubrification optimale et une protection complète du moteur.

Normes : JASO MA2 – API SL

BASIC

Viscosité	Conditionnement	Référence	Unitaire T.T.C.
10W40	1 L x 15	2800053	19,75 €
10W40	4 L x 6	2800054	67,85 €



R4000 RS

Semi-synthèse à base d'esters, haute performance, pour motos 4 temps, destiné à un usage régulier.

Normes : JASO MA2 – API SM

REGULAR

Viscosité	Conditionnement	Référence	Unitaire T.T.C.
10W40	1 L x 15	2800028	21,55 €
10W40	2 L x 8	2800029	38,50 €
10W40	4 L x 6	2800030	70,45 €
15W50	1 L x 15	2800369	21,55 €
15W50	4 L x 6	2800370	70,45 €

HUILES MOTEUR

Huiles



Stroke 2R

100% Synthetic avec ester

RACING

1L x 15 - 2800088

28,35 €
I.T.C.



Samourai

100% Synthetic avec ester

RACING

1L x 15 - 2800089

26,35 €
I.T.C.

1L x 15 Fraise - 2800090



R2000 RS

Synthetic Plus

REGULAR

1L x 15 - 2800104

21,70 €
I.T.C.



Self Oil

Synthetic Plus

BASIC

1L x 15 - 2800350

19,80 €
I.T.C.

1L x 15 Fraise - 2800352

2L x 8 - 2800379

36,90 €
I.T.C.



HUILES MOTEUR

VENTE À L'UNITÉ
 Livraison J+1

Huiles de fourche



Fork fluid

Huile de fourche
 100 % Synthetic
 Additif anti-friction
 Flacon de 1L

RACING

Grade 3 - 2800204
 Grade 7 - 2800208

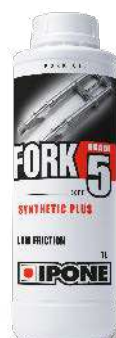
30,00 €
I.T.C.

Fork

Huile de fourche
 Synthetic Plus
 Basse friction
 Confort de pilotage

Grade	Référence	Flacon de 1L T.T.C.
5	2800212	
10	2800213	
15	2800214	25,80 €
20	2800215	
30	2800533	

Huile d'amortisseur

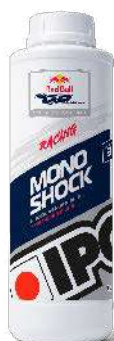

Mono Shock fluid

Huile amortisseur
 Synthetic avec ester
 Anti-friction et anti-emulsion
 Parfaite stabilité de la suspension

RACING

1L - 2800202

30,45 €
I.T.C.
HUILES DE FOURCHE ET D'AMORTISSEUR

Transmission



Box X-Trem

Huile de boîte

100 % Synthetic avec ester
Pour la compétition
Flacon de 1L

RACING

1L - 2800186

28,55 €
T.T.C.



Box 2

Huile de boîte

Synthetic avec ester
Pour boîte de vitesse séparée avec un embrayage humide. Haute protection JASO-MA2-GL4.
Flacon de 1L

Grade 3 - 2800189

20,85 €
T.T.C.

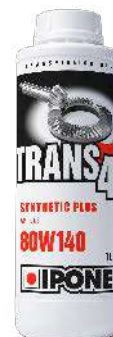

Trans 4

Huile de transmission

Mineral
Additifs extrême pression
Résistance aux fortes charges API GL5
Flacon de 1L

80W90 - 2800194

22,00 €
T.T.C.



Clutch One

Huile d'embrayage

Mineral
Assure progressivité, constance et facilité d'utilisation

125 ml - 2800545

11,60 €
T.T.C.



HUILES TRANSMISSION

Liquide de frein



VENTE À L'UNITÉ
Livraison J+1



X-Trem Brake

Liquide de frein

100 % Synthetic
Point d'ébullition à sec
328°C pour une parfaite
stabilité du fluide

RACING

500 ml - 2800544

34,00 €
I.T.C.



Brake DOT 4

Liquide de frein

100 % Synthetic
Point d'ébullition à sec
260°C
Adapté au système de
freinage ABS
Compatible DOT 3

500 ml - 2800312

16,30 €
I.T.C.



Brake DOT 5.1

Liquide de frein

100 % Synthetic
Point d'ébullition à sec
270°C
Adapté au système de
freinage ABS

500 ml - 2800313

17,60 €
I.T.C.

Liquide de refroidissement

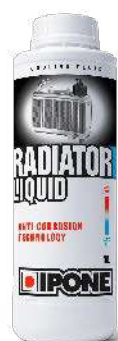

Radiator Liquid

Liquide de
refroidissement

Réduction de température
optimale
Protection antigel jusqu'à
-38°C/-36°F

1L - 2800219

20,80 €
I.T.C.



LIQUIDES FREIN/ REFROIDISSEMENT

Maintenance



X-Trem Chain

Lubrifiant chaîne
Lubrifie, protège et graisse

250 ml - 2800647

12,00 €
I.T.C.

750 ml - 2800648

24,70 €
I.T.C.



Chain Cleaner

Dégraissant chaîne
Dégraissant surpuissant
Compatible avec les joints
O-X-Z
Diffuseur multi-positions

750 ml - 2800649

24,70 €
I.T.C.



White Chain

Graisse de couleur
Lubrifie, protège
Couleur blanche

250 ml - 2800645

12,00 €
I.T.C.



Air Filter Oil

Huile filtre à air
Retient la poussière, le sable
et la boue
Séchage rapide

Liquide 50cl - 2800651

17,80 €
I.T.C.

Spray 75cl - 2800652

24,70 €
I.T.C.



Carbu Cleaner

Dégraissant carbu
Élimine les dépôts autour et
à l'intérieur du carburateur
Diffuseur multi-positions

750 ml - 2800650

24,70 €
I.T.C.



Air Filter Cleaner

Nettoyant filtre à air
40 utilisations

5L - 2800683

51,50 €
I.T.C.



Brake Cleaner

Dégraissant freins
Nettoie tout le système de
freinage
Séchage rapide
Diffuseur multi-positions

750 ml - 2800658

24,70 €
I.T.C.



Full Protect

Lubrifiant 6 en 1
Dégrippe, lubrifie, nettoie
Protège de l'humidité, des
contacts électriques et de la
corrosion
Diffuseur multi-positions

750 ml - 2800664

24,70 €
I.T.C.



Plastic Shine

Rénovateur plastique
À base de silicone
Effet neuf et brillant durable

750 ml - 2800666

24,70 €
I.T.C.



VENTE À L'UNITÉ
Livraison J+1



Cleaner Polish

Nettoyant à sec
Multi-surfaces
Finition brillante

750 ml - 2800669

24,70 €
I.T.C.



Moto Wash

Multi-surfaces
Formule moussante

1L - 2800670

18,35 €
I.T.C.

5L - 2800700

63,00 €
I.T.C.



Visor Rain Off

Effet déperlant
Améliore la visibilité

10 ml - 2800676

8,60 €
I.T.C.



Waterproof Grease

Graisse résistante à l'eau
Aluminium Complexe

200g - 2800673

19,60 €
I.T.C.



Hand Cleaner

Usage atelier
Microbilles actives
Senteur agrumes

4L - 2800681

88,30 €
I.T.C.



GAMME WD-40



Multifonction

Indispensable, parfait !



Flexible 600ml - 050021

18,25 €
I.T.C.

Recommandé sur

- Coudes d'échappement
- Câbles et poignées d'embrayage
- Grips de poignées
- Roues
- Câbles d'accélération
- Cadres
- Moteurs
- Sélecteurs
- Filtres à air
- Suspensions
- Écrous et boulons
- Boulons d'étriers de frein
- Repose-pieds



Double position

Pro 500ml - 050020

11,35 €
I.T.C.



200ml - 0500201

6,95 €
I.T.C.

220ml - 0500201-20

6,95 €
I.T.C.



200ml - 0500200

5,70 €
I.T.C.



5L - 050030

76,60 €
I.T.C.



Pulvérisateur - 050031

10,20 €
I.T.C.

Nettoyants



Nettoyant chaîne

400ml - 050040

10,80 €
T.T.C.

Facile à utiliser, il élimine rapidement saleté, crasse, poussière et huile de vos chaînes. Il sèche en quelques minutes et aide à réduire l'usure de vos chaînes ainsi qu'à maintenir leur niveau de performance sur la durée.

Avantages du produit :

Sèche rapidement
Ne laisse pas de résidus

Recommandé pour :

Chaîne / Bras oscillant / Transmission



Nettoyant freins

500ml - 050070

12,70 €
T.T.C.

Il élimine, poussières, liquide de freinage, saleté et huile des freins et systèmes d'embrayage. Il sèche rapidement et son utilisation régulière prolonge la durée de vie de vos disques et plaquettes de frein.

Avantages du produit :

Sans résidus
Réduit les grincements
Sèche rapidement

Recommandé pour :

Freins à disque / Étriers de frein / Embrayages



Nettoyant complet

1L - 0500500

14,05 €
T.T.C.

Conçu pour éliminer rapidement les dépôts de pollution et saletés provenant de la route. Sa formule procure une finition parfaite et est adaptée pour être utilisée sans risque sur l'ensemble de la moto !

Avantages du produit :

Polyvalence
Simple d'utilisation
Action rapide

Recommandé pour :

Carrosserie / Pièces mécaniques / Fibre de carbone



Lubrifiants

Lubrifiant chaîne

400ml - 050100

14,50 €
T.T.C.

Idéal pour les conditions sèches, il apporte une lubrification et une protection durable aux chaînes. Son action à séchage rapide et ses propriétés exceptionnelles anti-éclaboussures aident à augmenter la durée de vie des chaînes.

Avantages du produit :

Conditions sèches et séchage rapide
Propriétés anti-éclaboussures
Lubrification longue durée

Recommandé pour :

Chaîne / Transmission / Joints toriques en O, X et Z



Graisse chaîne

400ml - 050090

14,80 €
T.T.C.

Idéale en conditions humides, elle procure une protection anticorrosion exceptionnelle pour les chaînes. Grâce à l'ajout de PTFE, elle adhère et lubrifie sans projection, réduisant les frictions des pièces en mouvement.

Avantages du produit :

Conditions humides / séchage rapide
Propriétés anti-éclaboussures et anticorrosion

Recommandé pour :

Chaîne / Transmission / Joints toriques en O, X et Z

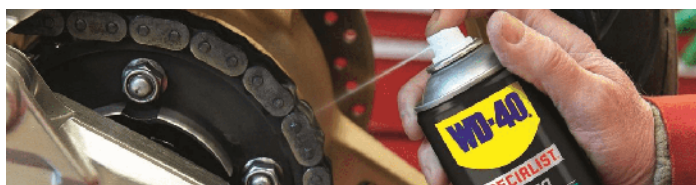

Lustreurs

Lustreur silicone

400ml - 050060

10,60 €
T.T.C.

Spécialement conçu pour donner une grande brillance à votre moto, sa formule à évaporation rapide agit rapidement, est facile à appliquer et ne nécessite pas de lustrage.

Avantages du produit :

Superbe brillance
Facilité d'utilisation sans polissage
Empêche le caoutchouc de craqueler et de vieillir

Recommandé pour :

Plastiques / Caoutchoucs / Métal / Fibre de carbone / Pièces exposées



Cire & polish

400ml - 050050

11,25 €
T.T.C.

Conçue pour donner aux motos une brillance extrême et longue durée, sa formule contient de la cire de Carnauba qui est une cire naturelle procurant un effet perlant et une superbe finition sans aucune trace.

Avantages du produit :

Brillance extrême
Sans trace / effet longue durée

Recommandé pour :

Parties peintes / Aluminium / Chrome / Métal / Plastiques



HUILES SUSPENSIONS

01M

Huile de fourche

Performances inégalées : amortissement et frottement. Protection maximale des joints. Elle est aussi utilisée par les préparateurs et recommandée par les constructeurs.

1L - 2921924

24,90 €
T.T.C.

5L - 2921926

110,00 €
T.T.C.

KYB



K2C

Huile amortisseurs

Conçue pour les motos récentes hautes performances. Indice de viscosité élevé pour obtenir un amortissement et une durabilité même sous de fortes températures. Additifs spéciaux pour réduire l'usure prématurée des pièces internes de l'amortisseur

1L - 2921928

24,90 €
T.T.C.

5L - 2921929

110,00 €
T.T.C.

KYB

Our precision, your advantage.

GAMME GS27 MOTO

Lavage



Ultra Wash super dégraissant

Nettoie et dégraisse en profondeur
élimine toutes les traces tenaces
Sans Acide et Anticorrosif
Compatible avec tous les matériaux
Parfum pomme

1L - M0120162

14,20 €
T.T.C.



Nettoyant Protecteur

Toutes surfaces
Élimine les tâches incrustées
Limite l'encrassement, protège de la corrosion
Peut s'utiliser sur les peintures mates

300ml - M0110162

11,20 €
T.T.C.

Lavage



Brosse jantes

Idéale pour les jantes, les pneus et le passage de roues.
Sans risque de rayures grâce à la tête de brosse entourée de caoutchouc.

Unitaire - OUI180120

17,90 €
I.T.C.

Gant de lavage

Triple Action, permet de nettoyer toutes la carrosserie comme un pro. Partie noire pour frotter, partie alvéolée pour démailloter sans rayer et sa surface micro-fibrée grise pour les tâches tenaces.
Lavable en machine

Unitaire - OUI180140

12,90 €
I.T.C.

Éponge lavage absolu

Éponge spéciale carrosserie 3 surfaces pour frotter sans rayures, démailloter et retirer les taches tenaces.

Unitaire - OUI180150

15,80 €
I.T.C.

Microfibre Séchage Extreme

Après un lavage, essuyer rapidement et sans effort avec la Microfibre format XXL 600x800 mm.
Absorbe 3x plus d'eau qu'une peau de chamois traditionnelle !

Unitaire - OUI180170

18,40 €
I.T.C.

Microfibre Double Face

Possède 2 faces ce qui permet de multiplier ses utilisations.
La partie noire est parfaite pour frotter lors du lavage ou pour essuyer la carrosserie.
Sa partie verte est idéale pour appliquer un lustreur ou un nettoyant vitres.

Unitaire - OUI180180

17,30 €
I.T.C.

Produits techniques



Graisse Chaîne Tout Terrain

Conditions extrêmes : eau, sable, boue, etc.
Graisse colorée blanche
Hydrofuge et anticorrosif
Protège et augmente la durée de vie de la chaîne
Embout précision

500ml - M0110131

15,30 €
I.T.C.

Dégraissant chaîne

Séchage rapide sans résidus
Élimine les dépôts incrustés
Maintient le niveau de performance de la chaîne
Jet Puissant
Compatible joints O-X-Z
Embout précision

500ml - M0110102

11,60 €
I.T.C.

Répare crevaison express

Réparation instantanée des pneus en 2 min chrono
Sans outils, sans démontage de la roue
Pour tous types de pneus, avec ou sans chambre à air

300ml - M0110221

10,20 €
I.T.C.

Entretien équipement du motard



Assainissant

Désinfecte et nettoie l'intérieur des casques, bottes, gants, blousons et combinaisons. Élimine les odeurs

Anti-bactérien
Séchage rapide.

250ml - M0110141

9,20 €
T.T.C.



Anti-pluie

Rend le support déperlant
Effet longue durée.
Améliore la visibilité pour plus de sécurité par temps de pluie.

250ml - M0110161

11,20 €
T.T.C.



Anti-buée

Évite la formation de buée due au froid et à la transpiration. Toutes surfaces soumises à la vapeur ou à la condensation. Améliore la visibilité

250ml - M0110181

11,20 €
T.T.C.



Imperméabilisant Anti-tâches

Tous textiles
Laisse une barrière protectrice sur les supports
N'altère pas la respirabilité
Non gras, non collant, non glissant

500ml - M0110132

11,20 €
T.T.C.



Casque extérieur

Formule moussante pour nettoyer casques et visières.
Ne laisse pas de trace.
Brillance et protection
Tous revêtements

250ml - M0110151

9,20 €
T.T.C.

Désinfection

NOUVEAUTÉS



Virucide

Utilisation toutes surfaces
Antibactérien,
fongicide
Norme EN14476+A1

400ml
M0110011

10,20 €
T.T.C.



GEL MAINS HYDROALCOOLIQUE

Bactéricide en 1min
norme EN 1500.
Virucide en 30s
norme EN 14476.

250ml x12
M0130011

57,40 €
T.T.C.
Le carton de 12



GEL MAINS HYDROALCOOLIQUE

Flacon 1L pour support mural.
Hauteur : 29cm
Largeur : 12cm
Profondeur : 11cm

1L
M0130012

15,20 €
T.T.C.



Support mural

Livré seul, sans gel.
Support inox pour gels hydroalcooliques ou savons.

Unitaire
M0130013

28,50 €
T.T.C.





La puissance sans compromis

Qualité supérieure sans entretien.

ENERYSAFE s'impose d'entrée comme la batterie polyvalente pour tous types de moto

ENERYSAFE
batteries / chargeurs

NOUVEAUTÉ





ÉLECTRICITÉ

BATTERIES /
CHARGEURS /
BOUGIES /
AMPOULES /







GUIDE D'APPLICATION



460



BATTERIES	514
CHARGEURS ENERGYSAFE	528
CHARGEURS LITHIUM	530
CHARGEURS OPTIMATE	532
CONNECTIQUE OPTIMATE	543
BOUGIES NGK	546
AMPOULES	550

Cyl	Modèle	Année	 € T.T.C.	 € T.T.C.	 € T.T.C.	 € T.T.C.	
ADLY							
50	RS XXL SuperSonic 50	05-10	ESTX4L-BS CTX4L(FA) 28,90 € 30,90 €	YTX4L-BS YTX4L(FA) 36,30 € 39,40 €	YTX4L-BS YTX4L(FA) 17,80 € 25,60 €		
300	ATV-Crossover Boost 300	07-12					
300	Hurricane 300	07-12					
300	Interceptor 300	07-12					
300	Sentinel 300	07-12					
AEON							
50	Cobra 50	03-11	ESTX4L-BS CTX4L(FA) 28,90 € 30,90 €	YTX4L-BS YTX4L(FA) 36,30 € 39,40 €	YTX4L-BS YTX4L(FA) 17,80 € 25,60 €		
50	Minikolt 50	03-07	ESTX4L-BS CTX4L(FA) 28,90 € 30,90 €	YTX4L-BS YTX4L(FA) 36,30 € 39,40 €	YTX4L-BS YTX4L(FA) 17,80 € 25,60 €		
50	Revo 50	04-07	ESTX4L-BS CTX4L(FA) 28,90 € 30,90 €	YTX4L-BS YTX4L(FA) 36,30 € 39,40 €	YTX4L-BS YTX4L(FA) 17,80 € 25,60 €		
100	Cobra 100	02-10	ESTX4L-BS CTX4L(FA) 28,90 € 30,90 €	YTX4L-BS YTX4L(FA) 36,30 € 39,40 €	YTX4L-BS YTX4L(FA) 17,80 € 25,60 €		
100	Revo 100	04-10	ESTX4L-BS CTX4L(FA) 28,90 € 30,90 €	YTX4L-BS YTX4L(FA) 36,30 € 39,40 €	YTX4L-BS YTX4L(FA) 17,80 € 25,60 €		
125	Cobra 125 RS	03-06					
125	Cobra 125 RS II	03-06					
125	Cobra Sport 125	02-09					
125	Cobra Utility 125	02-09					
125	Overland 125	02-09					
180	Cobra 180 RS	02-03					
180	Cobra 180 RS II	04-08					
180	Cobra Sport 180	02-03					
180	Overland 180	02-10					
180	Utility 180	05-10					
220	Cobra 220	05-10					
APRILIA							
350	Tuareg	86-89	ESB12AL-A2 64,40 €	YB12AL-A2 63,60 €	CB12AL-A2 CB12AL-A(FA) 52,80 € 62,50 €		
450	MXV450	09-14	ESTX7A-BS CTX7A(FA) 47,40 € 53,70 €	YTX7A-BS YTX7A(FA) 70,50 € 75,80 €	YTX7A-BS YTX7A(FA) 35,50 € 46,10 €		
450	RXV450	06-14	ESTX7A-BS CTX7A(FA) 47,40 € 53,70 €	YTX7A-BS YTX7A(FA) 70,50 € 75,80 €	YTX7A-BS YTX7A(FA) 35,50 € 46,10 €		
450	SXV450	06-14	ESTX7A-BS CTX7A(FA) 47,40 € 53,70 €	YTX7A-BS YTX7A(FA) 70,50 € 75,80 €	YTX7A-BS YTX7A(FA) 35,50 € 46,10 €		
550	RXV550	06-14	ESTX7A-BS CTX7A(FA) 47,40 € 53,70 €	YTX7A-BS YTX7A(FA) 70,50 € 75,80 €	YTX7A-BS YTX7A(FA) 35,50 € 46,10 €		
550	SXV550	06-14	ESTX7A-BS CTX7A(FA) 47,40 € 53,70 €	YTX7A-BS YTX7A(FA) 70,50 € 75,80 €	YTX7A-BS YTX7A(FA) 35,50 € 46,10 €		
ARCTIC CAT							
50	DVX50	06-11	ESTX5L-BS CTX5L(FA) 35,95 € 40,20 €	YTX5L-BS YTX5L(FA) 64,80 € 70,90 €	YTX5L-BS YTX5L(FA) 24,10 € 34,90 €		
90	2WD 90	02-05	ESTX4L-BS CTX4L(FA) 28,90 € 30,90 €	YTX4L-BS YTX4L(FA) 36,30 € 39,40 €	YTX4L-BS YTX4L(FA) 17,80 € 25,60 €		
90	DVX90	06-11	ESTX5L-BS CTX5L(FA) 35,95 € 40,20 €	YTX5L-BS YTX5L(FA) 64,80 € 70,90 €	YTX5L-BS YTX5L(FA) 24,10 € 34,90 €		
250	Cat 2x4 250	99-11	ESB14L-A2 65,80 €	YB14L-A2 70,30 €	CB14L-A2 YTX14AHL(FA) 57,80 € 80,60 €		
250	Cat 4x4 250	00-04	ESB14L-A2 65,80 €	YB14L-A2 70,30 €	CB14L-A2 YTX14AHL(FA) 57,80 € 80,60 €		
250	DVX250	06-08	ESTX12-BS CTX12(FA) 68,90 € 81,80 €	YTX12-BS YTX12(FA) 80,10 € 90,00 €	YTX12-BS YTX12(FA) 45,30 € 67,70 €		
300	Cat 2x4 300	98-04	ESB14L-A2 65,80 €	YB14L-A2 70,30 €	CB14L-A2 YTX14AHL(FA) 57,80 € 80,60 €		
300	Cat 4x4 300	05-11	ESB14L-A2 65,80 €	YB14L-A2 70,30 €	CB14L-A2 YTX14AHL(FA) 57,80 € 80,60 €		
400	Cat 2x4 400	98-01	ESB14-A2 65,80 €	YB14-A2 69,40 €	CB14-A2 63,60 €		
400	Cat 2x4 400	02-04	ESB14-A2 65,80 €	YB14-A2 69,40 €	CB14-A2 63,60 €		
400	Cat 2x4 400	05-08	ESB14-A2 65,80 €	YB14-A2 69,40 €	CB14-A2 63,60 €		







CATALOGUE ÉLECTRIQUE : Schémas, visuels, spécification et applications

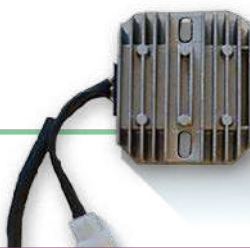

Cyl	Modèle	Année	 Skorich	€ T.T.C.	 STANDARD	€ T.T.C.	 Iridium	€ T.T.C.
ADLY								
50	RS XXL SuperSonic 50	05-10	HJTX5L-FP HJTZ5S-FP	55,10 € 77,10 €	BPR7HS	6,95 €	BPR7HIX	28,10 €
300	ATV-Crossover Boost 300	07-12			DR8ESL	6,65 €	DR8EIX	26,35 €
300	Hurricane 300	07-12			DR8ESL	6,65 €	DR8EIX	26,35 €
300	Interceptor 300	07-12			DR8ESL	6,65 €	DR8EIX	26,35 €
300	Sentinel 300	07-12			DR8ESL	6,65 €	DR8EIX	26,35 €
AEON								
50	Cobra 50	03-11	HJTX5L-FP HJTZ5S-FP	55,10 € 77,10 €	BPR7HS	6,95 €	BPR7HIX	28,10 €
50	Minikolt 50	03-07	HJTX5L-FP HJTZ5S-FP	55,10 € 77,10 €	BPR7HS	6,95 €	BPR7HIX	28,10 €
50	Revo 50	04-07	HJTX5L-FP HJTZ5S-FP	55,10 € 77,10 €	BPR7HS	6,95 €	BPR7HIX	28,10 €
100	Cobra 100	02-10	HJTX5L-FP HJTZ5S-FP	55,10 € 77,10 €	BPR7HS	6,95 €	BPR7HIX	28,10 €
100	Revo 100	04-10	HJTX5L-FP HJTZ5S-FP	55,10 € 77,10 €	BPR7HS	6,95 €	BPR7HIX	28,10 €
125	Cobra 125 RS	03-06			CR7HS	6,65 €	CR7HIX	26,86 €
125	Cobra 125 RS II	03-06			CR7HS	6,65 €	CR7HIX	26,86 €
125	Cobra Sport 125	02-09			CR8HSA	7,36 €	CR8HIX	26,86 €
125	Cobra Utility 125	02-09			CR7HS	6,65 €	CR7HIX	26,86 €
125	Overland 125	02-09			CR7HS	6,65 €	CR7HIX	26,86 €
180	Cobra 180 RS	02-03			CR7HS	6,65 €	CR7HIX	26,86 €
180	Cobra 180 RS II	04-08			CR7HSA	6,85 €	CR7HIX	26,86 €
180	Cobra Sport 180	02-03			CR8HSA	7,36 €	CR8HIX	26,86 €
180	Overland 180	02-10			CR7HS	6,65 €	CR7HIX	26,86 €
180	Utility 180	05-10			CR7HS	6,65 €	CR7HIX	26,86 €
220	Cobra 220	05-10			CR7HSA	6,85 €	CR7HIX	26,86 €
APRILIA								
350	Tuareg	86-89	HJTX14AHQ-FP	175,30 €				
450	MXV450	09-14	HJTX7A-FP	81,50 €	CR8EKB	19,50 €		
450	RXV450	06-14	HJTX7A-FP	81,50 €	CR8EB	13,60 €	CR8EIX	26,35 €
450	SXV450	06-14	HJTX7A-FP	81,50 €	CR8EB	13,60 €	CR8EIX	26,35 €
550	RXV550	06-14	HJTX7A-FP	81,50 €	CR8EB	13,60 €	CR8EIX	26,35 €
550	SXV550	06-14	HJTX7A-FP	81,50 €	CR8EB	13,60 €	CR8EIX	26,35 €
ARCTIC CAT								
50	DVX50	06-11	HJTX5L-FP HJTZ5S-FP	55,10 € 77,10 €				
90	2WD 90	02-05	HJTX5L-FP HJTZ5S-FP	55,10 € 77,10 €	BPR7HS	6,95 €	BPR7HIX	28,10 €
90	DVX90	06-11	HJTX5L-FP HJTZ5S-FP	55,10 € 77,10 €				
250	Cat 2x4 250	99-11	HJTX14AHQ-FP	175,30 €	DR7EA	6,95 €		
250	Cat 4x4 250	00-04	HJTX14AHQ-FP	175,30 €	DR7EA	6,95 €		
250	DVX250	06-08	HJTX14H-FP	109,90 €	DR7EA	6,95 €		
300	Cat 2x4 300	98-04	HJTX14AHQ-FP	175,30 €	DR7EA	6,95 €		
300	Cat 4x4 300	05-11	HJTX14AHQ-FP	175,30 €	DR7EA	6,95 €		
400	Cat 2x4 400	98-01	HJTX14AHQ-FP	175,30 €	CR8E	13,85 €		
400	Cat 2x4 400	02-04	HJTX14AHQ-FP	175,30 €	CR7E	14,10 €		
400	Cat 2x4 400	05-08	HJTX14AHQ-FP	175,30 €				

En ligne, moraco.fr/moraco/documents.





Cyl	Modèle	Année	 € T.T.C.	 € T.T.C.	 € T.T.C.	 € T.T.C.
ARCTIC CAT						
400	Cat 4x4 400	98-05	ESB14-A2 65,80 €	YB14-A2 69,40 €	CB14-A2 63,60 €	
400	DVX400	04-08	ESTX9-BS 53,90 € CTX9(FA) 59,30 €	YTX9-BS 64,10 € YTX9(FA) 72,40 €	YTX9-BS 34,80 € YTX9(FA) 51,20 €	
400	TBX 4x4 400	04-05	ESB14-A2 65,80 €	YB14-A2 69,40 €	CB14-A2 63,60 €	
500	Cat 2x4 500	98-04	ESB14-A2 65,80 €	YB14-A2 69,40 €	CB14-A2 63,60 €	
500	Cat 4x4 500	98-10	ESB14-A2 65,80 €	YB14-A2 69,40 €	CB14-A2 63,60 €	
500	TBX 4x4 500	02-10	ESB14-A2 65,80 €	YB14-A2 69,40 €	CB14-A2 63,60 €	
500	TRV 4x4 500	03-11	ESB14-A2 65,80 €	YB14-A2 69,40 €	CB14-A2 63,60 €	
650	Cat 4x4 650 H1	05-11	ESB14-A2 65,80 €	YB14-A2 69,40 €	CB14-A2 63,60 €	
650	Cat 4x4 650 V2 /LE	05-11	ESB14-A2 65,80 €	YB14-A2 69,40 €	CB14-A2 63,60 €	
650	Prowler XT 650 4x4 H1	06-11	ESB14-A2 65,80 €	YB14-A2 69,40 €	CB14-A2 63,60 €	
BETA						
50	RK 6 (enduro)	97-98				
50	RR50 Enduro	12-13				
50	RR50 Enduro Factory	12-16				
50	RR50 Enduro Std	12-15				
80	Evo 80 Junior (Trial) 17/19 pouces	12-15				
80	Evo 80 Senior (Trial)	12-15				
125	Alp 125	98-99				
125	Alp 125	00-05				
125	Evo 125 (Trial)	12-16				
125	Evo 125 (Trial)	17-22				
125	RR125 Enduro	15-16	ESTX5L-BS 35,95 € CTX5L(FA) 40,20 €	YTX5L-BS 64,80 € YTX5L(FA) 70,90 €	YTX5L-BS 24,10 € YTX5L(FA) 34,90 €	
125	RR125 Enduro	18-22	ESTX5L-BS 35,95 € CTX5L(FA) 40,20 €	YTX5L-BS 64,80 € YTX5L(FA) 70,90 €	YTX5L-BS 24,10 € YTX5L(FA) 34,90 €	
125	RR125 Enduro LC 4T	15-22	ESTX5L-BS 35,95 € CTX5L(FA) 40,20 €	YTX5L-BS 64,80 € YTX5L(FA) 70,90 €	YTX5L-BS 24,10 € YTX5L(FA) 34,90 €	
125	RR125Mortard LC	21-21	ESTX5L-BS 35,95 € CTX5L(FA) 40,20 €	YTX5L-BS 64,80 € YTX5L(FA) 70,90 €	YTX5L-BS 24,10 € YTX5L(FA) 34,90 €	
125	Zero (Trial)	90-92				
200	Alp 200	00-05	ESTX5L-BS 35,95 € CTX5L(FA) 40,20 €	YTX5L-BS 64,80 € YTX5L(FA) 70,90 €	YTX5L-BS 24,10 € YTX5L(FA) 34,90 €	
200	Alp 200	15-21				
200	EVO (Tial)	12-20				
200	RR200 Enduro	19-22	ESTX5L-BS 35,95 € CTX5L(FA) 40,20 €	YTX5L-BS 64,80 € YTX5L(FA) 70,90 €	YTX5L-BS 24,10 € YTX5L(FA) 34,90 €	
200	Urban	12-16				
240	Alp 240	90-97				
240	Gara (Trial) 240	93-93				
240	Super Trial	92-92				
240	Techno (Trial)	97-97				
247	Rev 3, 247	99-00				
247	Rev3, 247	01-02				
250	Alp 250	92-98				
250	EVO (Trial)	12-16				
250	EVO (Trial)	17-22				
250	EVO (Trial) 4T	12-19				
250	Rev3, 250	00-03				
250	RR250	05-07				
250	RR250 Enduro	13-15				
250	RR250 Enduro 2T	13-16				
250	RR250 Enduro 2T	17-22				







CATALOGUE ÉLECTRIQUE : Schémas, visuels, spécification et applications

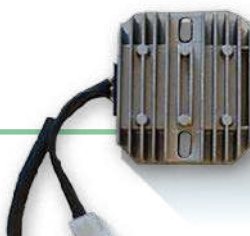

Cyl	Modèle	Année	 Skriich	€ T.T.C.	 STANDARD	€ T.T.C.	 IRIIDIUM	€ T.T.C.
ARCTIC CAT								
400	Cat 4x4 400	98-05	HJTX14AHQ-FP	175,30 €				
400	DVX400	04-08	HJTX9-FP	93,70 €	CR7E	14,10 €		
400	TBX 4x4 400	04-05	HJTX14AHQ-FP	175,30 €	CR7E	14,10 €	CR7EIX	27,35 €
500	Cat 2x4 500	98-04	HJTX14AHQ-FP	175,30 €	CR6E	13,80 €		
500	Cat 4x4 500	98-10	HJTX14AHQ-FP	175,30 €	CR6E	13,80 €		
500	TBX 4x4 500	02-10	HJTX14AHQ-FP	175,30 €	CR6E	13,80 €		
500	TRV 4x4 500	03-11	HJTX14AHQ-FP	175,30 €	CR6E	13,80 €		
650	Cat 4x4 650 H1	05-11	HJTX14AHQ-FP	175,30 €				
650	Cat 4x4 650 V2 /LE	05-11	HJTX14AHQ-FP	175,30 €				
650	Prowler XT 650 4x4 H1	06-11	HJTX14AHQ-FP	175,30 €	CPR8E	13,80 €		
BETA								
50	RK 6 (enduro)	97-98			B8ES	4,70 €	BR8EIX	26,75 €
50	RR50 Enduro	12-13			BR9ES	6,76 €	BR9EIX	26,35 €
50	RR50 Enduro Factory	12-16			BR9ES	6,76 €	BR9EIX	26,35 €
50	RR50 Enduro Std	12-15			BR9ES	6,76 €	BR9EIX	26,35 €
80	Evo 80 Junior (Trial) 17/19 pouces	12-15			BR8ES	6,35 €	BR8EIX	26,75 €
80	Evo 80 Senior (Trial)	12-15			BR8ES	6,35 €	BR8EIX	26,75 €
125	Alp 125	98-99			BP7ES	4,70 €	BPR7EIX	29,26 €
125	Alp 125	00-05			CR7HSA	6,85 €	CR7HIX	26,86 €
125	Evo 125 (Trial)	12-16			BR8ES	6,35 €	BR8EIX	26,75 €
125	Evo 125 (Trial)	17-22					GR7CI8	24,05 €
125	RR125 Enduro	15-16	HJTX5L-FP HJTZ5S-FP	55,10 € 77,10 €	CR7HSA	6,85 €	CR7HIX	26,86 €
125	RR125 Enduro	18-22	HJTX5L-FP HJTZ5S-FP	55,10 € 77,10 €			BR9ECMIX	26,86 €
125	RR125 Enduro LC 4T	15-22	HJTX5L-FP HJTZ5S-FP	55,10 € 77,10 €	CR8E	13,85 €	CR8EIX	26,35 €
125	RR125Mortard LC	21-21	HJTX5L-FP HJTZ5S-FP	55,10 € 77,10 €	CR8E	13,85 €	CR8EIX	26,35 €
125	Zero (Trial)	90-92			B8ES	4,70 €	BR8EIX	26,75 €
200	Alp 200	00-05	HJTX5L-FP HJTZ5S-FP	55,10 € 77,10 €	DR8EA	6,76 €	DR8EIX	26,35 €
200	Alp 200	15-21			BR7ES	7,06 €	BR7EIX	26,86 €
200	EVO (Tial)	12-20			BR7ES	7,06 €	BR7EIX	26,86 €
200	RR200 Enduro	19-22	HJTX5L-FP HJTZ5S-FP	55,10 € 77,10 €	BR8ECM	14,70 €	BR8ECMIX	26,86 €
200	Urban	12-16			DR8EA	6,76 €	DR8EIX	26,35 €
240	Alp 240	90-97			B8ES	4,70 €	BR8EIX	26,75 €
240	Gara (Trial) 240	93-93			B8ES	4,70 €	BR8EIX	26,75 €
240	Super Trial	92-92			B8ES	4,70 €	BR8EIX	26,75 €
240	Techno (Trial)	97-97			B8ES	4,70 €	BR8EIX	26,75 €
247	Rev 3, 247	99-00			BP7ES	4,70 €	BPR7EIX	29,26 €
247	Rev3, 247	01-02			BP7ES	4,70 €	BPR7EIX	29,26 €
250	Alp 250	92-98			BP7ES	4,70 €	BPR7EIX	29,26 €
250	EVO (Trial)	12-16			BR7ES	7,06 €	BR7EIX	26,86 €
250	EVO (Trial)	17-22					GR7CI8	24,05 €
250	EVO (Trial) 4T	12-19			CR7EB	13,66 €	CR7EIX	27,35 €
250	Rev3, 250	00-03			BP7ES	4,70 €	BPR7EIX	29,26 €
250	RR250	05-07			BR8ES	6,35 €	BR8EIX	26,75 €
250	RR250 Enduro	13-15			DCPR8E	11,86 €	DCPR8EIX	29,30 €
250	RR250 Enduro 2T	13-16			BR8ES	6,35 €	BR8EIX	26,75 €
250	RR250 Enduro 2T	17-22	HJTZ5S-FP	77,10 €	BR8ES BR8ECM	6,35 € 14,70 €	BR8EIX BR8ECMIX	26,75 € 26,86 €

En ligne, moraco.fr/moraco/documents.



Cyl	Modèle	Année	 € T.T.C.	 € T.T.C.	 € T.T.C.	 € T.T.C.
BETA						
250	Techno (Trial)	96-98				
250	XTrainer	18-22	ESTX5L-BS CTX5L(FA) 35,95 € 40,20 €	YTX5L-BS YTX5L(FA) 64,80 € 70,90 €	YTX5L-BS YTX5L(FA) 24,10 € 34,90 €	
250	Zero (Trial)	91-91				
260	Alp 260 (Trial)	96-96				
260	Synt (Trial)	92-92				
260	TR34, 35, Zero	89-89				
270	Techno (Trial)	98-98				
300	300RR Enduro	11-17				
300	300RR Enduro 2T	13-13				
300	300RR Enduro 2T	14-16				
300	300RR Enduro 2T	17-21				
300	300RR Enduro 2T	22-22				
300	EVO (Trial)	09-16				
300	EVO (Trial)	17-22				
300	EVO (Trial) 4T	12-20				
300	EVO (Trial) 4T	21-22				
300	XTrainer	18-22	ESTX5L-BS CTX5L(FA) 35,95 € 40,20 €	YTX5L-BS YTX5L(FA) 64,80 € 70,90 €	YTX5L-BS YTX5L(FA) 24,10 € 34,90 €	
350	350RR Enduro	12-16				
350	350RR Enduro	17-22	ESTZ7S 54,90 €	YTZ7S 162,90 €	YTZ7S 43,90 €	F4977 69,30 €
350	Alp 4.0 350	04-05	ESTX7L-BS CTX7L(FA) 49,60 € 52,90 €	YTX7L-BS YTX7L(FA) 70,50 € 75,20 €	YTX7L-BS YTX7L(FA) 33,40 € 47,30 €	
350	Motard 4.0 350	04-05				
390	RR390 Enduro	14-22	ESTZ7S 54,90 €	YTZ7S 162,90 €	YTZ7S 43,90 €	F4977 69,30 €
400	RR400 Enduro	05-09	ESTX5L-BS CTX5L(FA) 35,95 € 40,20 €	YTX5L-BS YTX5L(FA) 64,80 € 70,90 €	YTX5L-BS YTX5L(FA) 24,10 € 34,90 €	
400	RR400 Enduro	10-15	ESTX5L-BS CTX5L(FA) 35,95 € 40,20 €	YTX5L-BS YTX5L(FA) 64,80 € 70,90 €	YTX5L-BS YTX5L(FA) 24,10 € 34,90 €	
430	RR430 Enduro	13-22	ESTZ7S 54,90 €	YTZ7S 162,90 €	YTZ7S 43,90 €	F4977 69,30 €
450	RR450 Enduro	05-09	ESTX5L-BS CTX5L(FA) 35,95 € 40,20 €	YTX5L-BS YTX5L(FA) 64,80 € 70,90 €	YTX5L-BS YTX5L(FA) 24,10 € 34,90 €	
450	RR450 Enduro	10-15	ESTX5L-BS CTX5L(FA) 35,95 € 40,20 €	YTX5L-BS YTX5L(FA) 64,80 € 70,90 €	YTX5L-BS YTX5L(FA) 24,10 € 34,90 €	
480	RR480 Enduro	13-22	ESTZ7S 54,90 €	YTZ7S 162,90 €	YTZ7S 43,90 €	F4977 69,30 €
498	RR498 Enduro	12-15	ESTX5L-BS CTX5L(FA) 35,95 € 40,20 €	YTX5L-BS YTX5L(FA) 64,80 € 70,90 €	YTX5L-BS YTX5L(FA) 24,10 € 34,90 €	
520	RR520 Enduro	13-15	ESTX5L-BS CTX5L(FA) 35,95 € 40,20 €	YTX5L-BS YTX5L(FA) 64,80 € 70,90 €	YTX5L-BS YTX5L(FA) 24,10 € 34,90 €	
525	RR525 Enduro	05-12	ESTX5L-BS CTX5L(FA) 35,95 € 40,20 €	YTX5L-BS YTX5L(FA) 64,80 € 70,90 €	YTX5L-BS YTX5L(FA) 24,10 € 34,90 €	
BMW						
450	G450 X	08-11	ESTZ7S 54,90 €	YTZ7S 162,90 €	YTZ7S 43,90 €	F4977 69,30 €
BOMBARDIER						
50	DS50	02-06	ESTX4L-BS CTX4L(FA) 28,90 € 30,90 €	YTX4L-BS YTX4L(FA) 36,30 € 39,40 €	YTX4L-BS YTX4L(FA) 17,80 € 25,60 €	
50	Goes 50	06-06	ESTX4L-BS CTX4L(FA) 28,90 € 30,90 €	YTX4L-BS YTX4L(FA) 36,30 € 39,40 €	YTX4L-BS YTX4L(FA) 17,80 € 25,60 €	
50	Quest 50	03-04	ESTX4L-BS CTX4L(FA) 28,90 € 30,90 €	YTX4L-BS YTX4L(FA) 36,30 € 39,40 €	YTX4L-BS YTX4L(FA) 17,80 € 25,60 €	
90	DS90	02-06	ESTX4L-BS CTX4L(FA) 28,90 € 30,90 €	YTX4L-BS YTX4L(FA) 36,30 € 39,40 €	YTX4L-BS YTX4L(FA) 17,80 € 25,60 €	
90	Quest 90	03-04	ESTX4L-BS CTX4L(FA) 28,90 € 30,90 €	YTX4L-BS YTX4L(FA) 36,30 € 39,40 €	YTX4L-BS YTX4L(FA) 17,80 € 25,60 €	
200	Rally 200	03-06			CB14A-A2 63,60 €	
220	Goes 220	05-06	ESTX12-BS CTX12(FA) 68,90 € 81,80 €	YTX12-BS YTX12(FA) 80,10 € 90,00 €	YTX12-BS YTX12(FA) 45,30 € 67,70 €	







CATALOGUE ÉLECTRIQUE : Schémas, visuels, spécification et applications

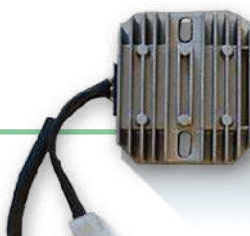

Cyl	Modèle	Année	Skriich	€ T.T.C.	NGK STANDARD	€ T.T.C.	NGK IRIIDIUM	€ T.T.C.
BETA								
250	Techno (Trial)	96-98			BP7ES	4,70 €	BPR7EIX	29,26 €
250	XTrainer	18-22	HJTX5L-FP HJTZ5S-FP	55,10 € 77,10 €			GR7C18	24,05 €
250	Zero (Trial)	91-91			B8ES	4,70 €	BR8EIX	26,75 €
260	Alp 260 (Trial)	96-96			B8ES	4,70 €	BR8EIX	26,75 €
260	Synt (Trial)	92-92			B8ES	4,70 €	BR8EIX	26,75 €
260	TR34, 35, Zero	89-89			B8ES	4,70 €	BR8EIX	26,75 €
270	Techno (Trial)	98-98			BP7ES	4,70 €	BPR7EIX	29,26 €
300	300RR Enduro	11-17			DCPR8E	11,86 €	DCPR8EIX	29,30 €
300	300RR Enduro 2T	13-13			DCPR8E	11,86 €	DCPR8EIX	29,30 €
300	300RR Enduro 2T	14-16			BPR7ES BR7ES	5,95 € 7,06 €		
300	300RR Enduro 2T	17-21	HJTZ5S-FP	77,10 €	BR7ES	7,06 €	BR7EIX	26,86 €
300	300RR Enduro 2T	22-22	HJTZ5S-FP	77,10 €	GR7C18	24,05 €		
300	EVO (Trial)	09-16			BR7ES	7,06 €	BR7EIX	26,86 €
300	EVO (Trial)	17-22					GR7C18	24,05 €
300	EVO (Trial) 4T	12-20			CR7EB	13,66 €	CR7EIX	27,35 €
300	EVO (Trial) 4T	21-22			MR7B18	48,20 €		
300	XTrainer	18-22	HJTX5L-FP HJTZ5S-FP	55,10 € 77,10 €			GR7C18	24,05 €
350	350RR Enduro	12-16			LKAR8A9	32,00 €		
350	350RR Enduro	17-22	HJTZ7S-FP	99,20 €	LKAR8A9	32,00 €		
350	Alp 4.0 350	04-05	HJTZ7S-FP	99,20 €	CR9EK	18,76 €	CR9EIX	26,35 €
350	Motard 4.0 350	04-05			CR9EK	18,76 €	CR9EIX	26,35 €
390	RR390 Enduro	14-22	HJTZ7S-FP HJTZ7S-FPZ	99,20 € 164,30 €	LKAR8A9	32,00 €		
400	RR400 Enduro	05-09	HJTX5L-FP HJTZ5S-FP	55,10 € 77,10 €	DCPR8E	11,86 €	DCPR8EIX	29,30 €
400	RR400 Enduro	10-15	HJTX5L-FP HJTZ5S-FP	55,10 € 77,10 €	LKAR8A9	32,00 €		
430	RR430 Enduro	13-22	HJTZ7S-FP HJTZ7S-FPZ	99,20 € 164,30 €	LKAR8A9	32,00 €		
450	RR450 Enduro	05-09	HJTX5L-FP HJTZ5S-FP	55,10 € 77,10 €	DCPR8E	11,86 €	DCPR8EIX	29,30 €
450	RR450 Enduro	10-15	HJTX5L-FP HJTZ5S-FP	55,10 € 77,10 €	LKAR8A9	32,00 €		
480	RR480 Enduro	13-22	HJTZ7S-FP HJTZ7S-FPZ	99,20 € 164,30 €	LKAR8A9	32,00 €		
498	RR498 Enduro	12-15	HJTX5L-FP HJTZ5S-FP	55,10 € 77,10 €	LKAR8A9	32,00 €		
520	RR520 Enduro	13-15	HJTX5L-FP HJTZ5S-FP	55,10 € 77,10 €	LKAR8A9	32,00 €		
525	RR525 Enduro	05-12	HJTX5L-FP HJTZ5S-FP	55,10 € 77,10 €	DCPR8E	11,86 €	DCPR8EIX	29,30 €
BMW								
450	G450 X	08-11	HJTZ7S-FP HJTZ7S-FPZ	99,20 € 164,30 €	CR9EKB	20,50 €	CR9EIX	26,35 €
BOMBARDIER								
50	DS50	02-06	HJTX5L-FP HJTZ5S-FP	55,10 € 77,10 €	BPR7HS	6,95 €	BPR7HIX	28,10 €
50	Goes 50	06-06	HJTX5L-FP HJTZ5S-FP	55,10 € 77,10 €	BPR7HS	6,95 €	BPR7HIX	28,10 €
50	Quest 50	03-04	HJTX5L-FP HJTZ5S-FP	55,10 € 77,10 €	BPR7HS	6,95 €	BPR7HIX	28,10 €
90	DS90	02-06	HJTX5L-FP HJTZ5S-FP	55,10 € 77,10 €	BPR7HS	6,95 €	BPR7HIX	28,10 €
90	Quest 90	03-04	HJTX5L-FP HJTZ5S-FP	55,10 € 77,10 €	BPR7HS	6,95 €	BPR7HIX	28,10 €
200	Rally 200	03-06			CR8E	13,85 €	CR8EIX	26,35 €
220	Goes 220	05-06	HJTX14H-FP	109,90 €				

En ligne, moraco.fr/moraco/documents.



Cyl	Modèle	Année	 € T.T.C.	 € T.T.C.	 € T.T.C.	 € T.T.C.	
BOMBARDIER							
250	DS250	06-06	ESTX12-BS CTX12(FA) 68,90 € 81,80 €	YTX12-BS YTX12(FA) 80,10 € 90,00 €	YTX12-BS YTX12(FA) 45,30 € 67,70 €		
330	Outlander 330	04-06		Y4815627 215,10 €			
400	Outlander 400 /Max	03-06	ESTX20L-BS 100,90 €	YTX20L-BS YTX20L(FA) 154,10 € 173,60 €	YTX20L-BS YTX20L(FA) 77,90 € 96,90 €		
500	Quest 500	02-06		YB16L-B			
500	Traxter 500	99-99		YB16L-B			
500	Traxter 500	00-00	ESTX20L-BS 100,90 €	YTX20L-BS 154,10 €	YTX20L-BS 77,90 €		
500	Traxter 500	01-06		YB16L-B			
500	Traxter 500 Max	03-05		YB16L-B			
650	DS650 Desert Storm	00-06		Y4815627 215,10 €			
650	Quest 650	02-06		YB16L-B			
650	Quest 650 Max	03-06		YB16L-B			
800	Outlander 800	06-06	ESTX20L-BS 100,90 €	YTX20L-BS YTX20L(FA) 154,10 € 173,60 €	YTX20L-BS YTX20L(FA) 77,90 € 96,90 €		
800	Outlander 800 XT	06-06	ESTX20L-BS 100,90 €	YTX20L-BS YTX20L(FA) 154,10 € 173,60 €	YTX20L-BS YTX20L(FA) 77,90 € 96,90 €		
CPI							
250	XS250	05-10					
DERBI							
250	DRX250	04-10					
DINLI							
50	Dino 50	00-04					
50	Helix 50	00-04					
50	T-Rex 50	00-04					
100	Helix 100	00-04					
E-TON							
40	Rascal IXL-40	98-01	EST12B-4 78,80 €	YT12B-BS YT12B(FA) 108,40 € 118,00 €	YT12B-4 56,10 €		
40	Viper JXL-40 JR /E	03-03	EST12B-4 78,80 €	YT12B-BS YT12B(FA) 108,40 € 118,00 €	YT12B-4 56,10 €		
50	Lightning AXL-50	99-03	ESTX4L-BS CTX4L(FA) 28,90 € 30,90 €	YTX4L-BS YTX4L(FA) 36,30 € 39,40 €	YTX4L-BS YTX4L(FA) 17,80 € 25,60 €		
50	Thunder TXL-50	99-03	ESTX4L-BS CTX4L(FA) 28,90 € 30,90 €	YTX4L-BS YTX4L(FA) 36,30 € 39,40 €	YTX4L-BS YTX4L(FA) 17,80 € 25,60 €		
50	Viper NXL-50	99-03	ESTX4L-BS CTX4L(FA) 28,90 € 30,90 €	YTX4L-BS YTX4L(FA) 36,30 € 39,40 €	YTX4L-BS YTX4L(FA) 17,80 € 25,60 €		
50	Viper RXL-50 /M	03-07	ESTX4L-BS CTX4L(FA) 28,90 € 30,90 €	YTX4L-BS YTX4L(FA) 36,30 € 39,40 €	YTX4L-BS YTX4L(FA) 17,80 € 25,60 €		
90	Sierra DXL-90	03-09	ESTX4L-BS CTX4L(FA) 28,90 € 30,90 €	YTX4L-BS YTX4L(FA) 36,30 € 39,40 €	YTX4L-BS YTX4L(FA) 17,80 € 25,60 €		
90	Thunder AXL-90	99-03	ESTX4L-BS CTX4L(FA) 28,90 € 30,90 €	YTX4L-BS YTX4L(FA) 36,30 € 39,40 €	YTX4L-BS YTX4L(FA) 17,80 € 25,60 €		
90	Thunder NXL-90	99-03	ESTX4L-BS CTX4L(FA) 28,90 € 30,90 €	YTX4L-BS YTX4L(FA) 36,30 € 39,40 €	YTX4L-BS YTX4L(FA) 17,80 € 25,60 €		
90	Thunder TXL-90	99-03	ESTX4L-BS CTX4L(FA) 28,90 € 30,90 €	YTX4L-BS YTX4L(FA) 36,30 € 39,40 €	YTX4L-BS YTX4L(FA) 17,80 € 25,60 €		
90	Viper RXL-90 /R	03-11	ESTX4L-BS CTX4L(FA) 28,90 € 30,90 €	YTX4L-BS YTX4L(FA) 36,30 € 39,40 €	YTX4L-BS YTX4L(FA) 17,80 € 25,60 €		
150	Challenger CXL-150	03-11	ESTX9-BS CTX9(FA) 53,90 € 59,30 €	YTX9-BS YTX9(FA) 64,10 € 72,40 €	YTX9-BS YTX9(FA) 34,80 € 51,20 €		
150	Yukon EXL-150	03-11	ESTX9-BS CTX9(FA) 53,90 € 59,30 €	YTX9-BS YTX9(FA) 64,10 € 72,40 €	YTX9-BS YTX9(FA) 34,80 € 51,20 €		
150	Yukon EXL-150	12-12					
150	Yukon YXL-150	00-02	ESTX9-BS CTX9(FA) 53,90 € 59,30 €	YTX9-BS YTX9(FA) 64,10 € 72,40 €	YTX9-BS YTX9(FA) 34,80 € 51,20 €		
FANTIC							
125	XE 125	21-22					
125	XX 125	21-22					
250	XEF 250	21-22	ESTZ7S 54,90 €	YTZ7S 162,90 €	YTZ7S 43,90 €	F4977 69,30 €	







CATALOGUE ÉLECTRIQUE : Schémas, visuels, spécification et applications

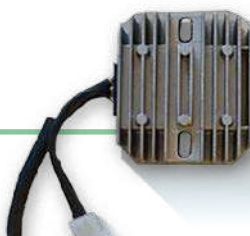

Cyl	Modèle	Année	Skriich	€ T.T.C.	NGK STANDARD	€ T.T.C.	NGK IRIIDIUM	€ T.T.C.
BOMBARDIER								
250	DS250	06-06	HJTX14H-FP	109,90 €				
330	Outlander 330	04-06			DCPR8E	11,86 €	DCPR8EIX	29,30 €
400	Outlander 400 /Max	03-06	HJTX20HQ-FP	242,70 €	DCPR8E	11,86 €	DCPR8EIX	29,30 €
500	Quest 500	02-06	HJTX20HQ-FP	242,70 €	DCPR8E	11,86 €	DCPR8EIX	29,30 €
500	Traxter 500	99-99	HJTX20HQ-FP	242,70 €	DR8EA	6,76 €	DR8EIX	26,35 €
500	Traxter 500	00-00	HJTX20HQ-FP	242,70 €	DR8EA	6,76 €	DR8EIX	26,35 €
500	Traxter 500	01-06	HJTX20HQ-FP	242,70 €				
500	Traxter 500 Max	03-05	HJTX20HQ-FP	242,70 €	DR8EA	6,76 €	DR8EIX	26,35 €
650	DS650 Desert Storm	00-06			DR8EA	6,76 €	DR8EIX	26,35 €
650	Quest 650	02-06	HJTX20HQ-FP	242,70 €	DR8EA	6,76 €	DR8EIX	26,35 €
650	Quest 650 Max	03-06	HJTX20HQ-FP	242,70 €				
800	Outlander 800	06-06	HJTX20HQ-FP	242,70 €	DCPR8E	11,86 €	DCPR8EIX	29,30 €
800	Outlander 800 XT	06-06	HJTX20HQ-FP	242,70 €	DCPR8E	11,86 €	DCPR8EIX	29,30 €
CPI								
250	XS250	05-10			CR7HSA	6,85 €	CR7HIX	26,86 €
DERBI								
250	DRX250	04-10			CR8HS	6,20 €	CR8HIX	26,86 €
DINLI								
50	Dino 50	00-04			BPR7HS	6,95 €	BPR7HIX	28,10 €
50	Helix 50	00-04			BPR7HS	6,95 €	BPR7HIX	28,10 €
50	T-Rex 50	00-04			BPR7HS	6,95 €	BPR7HIX	28,10 €
100	Helix 100	00-04			BPR7HS	6,95 €	BPR7HIX	28,10 €
E-TON								
40	Rascal IXL-40	98-01	HJT12B-FP	164,30 €	BPM7A	4,36 €		
40	Viper JXL-40 JR /E	03-03	HJT12B-FP	164,30 €	BPM7A	4,36 €		
50	Lightning AXL-50	99-03	HJTX5L-FP HJTZ5S-FP	55,10 € 77,10 €	BPR7HS	6,95 €		
50	Thunder TXL-50	99-03	HJTX5L-FP HJTZ5S-FP	55,10 € 77,10 €	BPR7HS	6,95 €		
50	Viper NXL-50	99-03	HJTX5L-FP HJTZ5S-FP	55,10 € 77,10 €	BPR7HS	6,95 €		
50	Viper RXL-50 /M	03-07	HJTX5L-FP HJTZ5S-FP	55,10 € 77,10 €	BPR7HS	6,95 €		
90	Sierra DXL-90	03-09	HJTX5L-FP HJTZ5S-FP	55,10 € 77,10 €	BPR7HS	6,95 €	BPR7HIX	28,10 €
90	Thunder AXL-90	99-03	HJTX5L-FP HJTZ5S-FP	55,10 € 77,10 €	BPR7HS	6,95 €	BPR7HIX	28,10 €
90	Thunder NXL-90	99-03	HJTX5L-FP HJTZ5S-FP	55,10 € 77,10 €	BPR7HS	6,95 €	BPR7HIX	28,10 €
90	Thunder TXL-90	99-03	HJTX5L-FP HJTZ5S-FP	55,10 € 77,10 €	BPR7HS	6,95 €	BPR7HIX	28,10 €
90	Viper RXL-90 /R	03-11	HJTX5L-FP HJTZ5S-FP	55,10 € 77,10 €	BPR7HS	6,95 €	BPR7HIX	28,10 €
150	Challenger CXL-150	03-11	HJTX9-FP	93,70 €	C7HSA	5,86 €	CR7HIX	26,86 €
150	Yukon EXL-150	03-11	HJTX9-FP	93,70 €	C7HSA	5,86 €	CR7HIX	26,86 €
150	Yukon EXL-150	12-12			C7HSA	5,86 €	CR7HIX	26,86 €
150	Yukon YXL-150	00-02	HJTX9-FP	93,70 €	C7HSA	5,86 €	CR7HIX	26,86 €
FANTIC								
125	XE 125	21-22					BR9EIX	26,35 €
125	XX 125	21-22					BR9EIX	26,35 €
250	XEF 250	21-22	HJTZ7S-FP HJTZ7S-FPZ	99,20 € 164,30 €	LMAR8EJ	-		

En ligne, moraco.fr/moraco/documents.



Cyl	Modèle	Année	 € T.T.C.	 € T.T.C.	 € T.T.C.	 € T.T.C.
FANTIC						
250	XX 250	22-22				
250	XXF 250	22-22				
450	XEF 450	22-22	ESTZ7S 54,90 €	YTZ7S 162,90 €	YTZ7S 43,90 €	F4977 69,30 €
450	XXF 450	22-22				
GAS GAS						
50	EC50 Boy	00-00				
50	EC50 Boy	01-07				
50	MC50	21-22				
65	MC65	21-22				
85	MC85 14/17 pouces	22-22				
85	MC85 16/19 pouces	21-22				
125	EC125	97-14				
125	MC125	01-13				
125	MC125	21-22				
125	Pampera 125	96-04				
125	SM125	02-09				
125	TXT125	00-03				
125	TXT125 Pro	04-17				
125	TXT125 Racing	18-22				
200	EC200	99-03				
200	EC200	04-18				
200	EC200	19-20				
200	EC200 Hobby	07-13				
200	EC200 Ranger	19-20				
200	MC200	04-08				
200	TXT200	00-13				
250	EC250	96-17				
250	EC250	18-20				
250	EC250	21-22		YTZ5S 77,40 €		
250	EC250F	21-22				
250	JT25 250	95-99				
250	MC250	97-07				
250	MC250	22-22				
250	MC250F	21-22		YTZ5S 77,40 €		
250	Pampera 250	97-04	ESTX4L-BS 28,90 € CTX4L(FA) 30,90 €	YTX4L-BS 36,30 € YTX4L(FA) 39,40 €	YTX4L-BS 17,80 € YTX4L(FA) 25,60 €	
250	TXT249	00-01				
250	TXT250	02-22				
270	TX270	97-99				
280	TXT280	00-22				
300	EC300	99-17				
300	EC300	18-20				
300	EC300	21-22		YTZ5S 77,40 €		
300	EC300 Ranger	19-20				
300	TXT300	04-06				
300	TXT300 Pro	07-22				
300	Wild HP 300	03-05				







CATALOGUE ÉLECTRIQUE : Schémas, visuels, spécification et applications

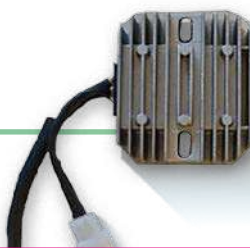

Cyl	Modèle	Année	Skriich	€ T.T.C.	NGK STANDARD	€ T.T.C.	NGK IRIIDIUM	€ T.T.C.
FANTIC								
250	XX 250	22-22			BR8EG	14,05 €	BR8EIX	26,75 €
250	XXF 250	22-22			LMAR9EJ	33,55 €		
450	XEF 450	22-22	HJTZ7S-FP HJTZ7S-FPZ	99,20 € 164,30 €	CPR8EA9	18,46 €		
450	XXF 450	22-22	LFP02	-	LMAR8G	17,60 €		
GAS GAS								
50	EC50 Boy	00-00			B8HS	5,20 €	BR8HIX	27,55 €
50	EC50 Boy	01-07			B9ES	5,35 €	BR9EIX	26,35 €
50	MC50	21-22			LR8B	16,10 €		
65	MC65	21-22			LR8B	16,10 €		
85	MC85 14/17 pouces	22-22			BR9ECMIX	26,86 €	BR9ECMIX	26,86 €
85	MC85 16/19 pouces	21-22			BR9ECMIX	26,86 €	BR9ECMIX	26,86 €
125	EC125	97-14			BR9EG	14,65 €		
125	MC125	01-13			BR9EG	14,65 €		
125	MC125	21-22			BR9ECMIX	26,86 €	BR9ECMIX	26,86 €
125	Pampera 125	96-04			BPR6ES	6,05 €	BPR6EIX	28,00 €
125	SM125	02-09			BR9EG	14,65 €		
125	TXT125	00-03			BPR5ES	5,86 €	BPR5EIX	29,40 €
125	TXT125 Pro	04-17			BPR5ES	5,86 €	BPR5EIX	29,40 €
125	TXT125 Racing	18-22			BPR5ES	5,86 €	BPR5EIX	29,40 €
200	EC200	99-03			B10EGV	18,98 €		
200	EC200	04-18			BR8EG	14,05 €		
200	EC200	19-20	HJTZ7S-FP HJTZ7S-FPZ	99,20 € 164,30 €	BR8EG	14,05 €		
200	EC200 Hobby	07-13			BR8EG	14,05 €		
200	EC200 Ranger	19-20	HJTZ7S-FP HJTZ7S-FPZ	99,20 € 164,30 €	BR8EG	14,05 €		
200	MC200	04-08			BR8EG	14,05 €		
200	TXT200	00-13			BPR5ES	5,86 €	BPR5EIX	29,40 €
250	EC250	96-17			BR8EG	14,05 €		
250	EC250	18-20	HJTZ7S-FP HJTZ7S-FPZ	99,20 € 164,30 €	BR8EG	14,05 €		
250	EC250	21-22	HJTZ5S-FP HJTZ7S-FP	77,10 € 99,20 €	BR7ES	7,06 €		
250	EC250F	21-22					LMAR9A10	35,35 €
250	JT25 250	95-99			BP5ES	4,85 €	BPR5EIX	29,40 €
250	MC250	97-07			BR8EG	14,05 €		
250	MC250	22-22			BR8ECM	14,70 €	BR8ECMIX	26,86 €
250	MC250F	21-22	HJTZ5S-FP	77,10 €			LMAR9A8	42,16 €
250	Pampera 250	97-04	HJTX5L-FP HJTZ5S-FP	55,10 € 77,10 €	BPR6ES	6,05 €	BPR6EIX	28,00 €
250	TXT249	00-01			BPR5ES	5,86 €	BPR5EIX	29,40 €
250	TXT250	02-22			BPR5ES	5,86 €	BPR5EIX	29,40 €
270	TX270	97-99			BPR5ES	5,86 €	BPR5EIX	29,40 €
280	TXT280	00-22			BPR5ES	5,86 €	BPR5EIX	29,40 €
300	EC300	99-17			BR8EG	14,05 €		
300	EC300	18-20	HJTZ7S-FP HJTZ7S-FPZ	99,20 € 164,30 €	BR8EG	14,05 €		
300	EC300	21-22	HJTZ5S-FP HJTZ7S-FP	77,10 € 99,20 €	BR7ES	7,06 €		
300	EC300 Ranger	19-20	HJTZ7S-FP HJTZ7S-FPZ	99,20 € 164,30 €	BR8EG	14,05 €		
300	TXT300	04-06			BPR5ES	5,86 €	BPR5EIX	29,40 €
300	TXT300 Pro	07-22			BPR5ES	5,86 €	BPR5EIX	29,40 €
300	Wild HP 300	03-05			BR8EG	14,05 €		

En ligne, moraco.fr/moraco/documents.





Cyl	Modèle	Année	 € T.T.C.	 € T.T.C.	 € T.T.C.	 € T.T.C.
GAS GAS						
320	TX320	97-99				
350	EC350F	21-22		YTZ5S	77,40 €	
350	JT35 350	95-95				
350	MC350F	22-22		YTZ5S	77,40 €	
370	Pampera 370	96-99	ESTX4L-BS CTX4L(FA) 28,90 € 30,90 €	YTX4L-BS YTX4L(FA) 36,30 € 39,40 €	YTX4L-BS YTX4L(FA) 17,80 € 25,60 €	
400	EC400 FSE	02-09	ESTZ7S 54,90 €	YTZ7S 162,90 €	YTZ7S 43,90 €	F4977 69,30 €
400	Pampera 400	05-09				
450	EC450 FSE	99-01				
450	EC450 FSE	02-06	ESTZ7S 54,90 €	YTZ7S 162,90 €	YTZ7S 43,90 €	F4977 69,30 €
450	EC450 FSR	07-14				
450	MC450F	21-22		YTZ5S	77,40 €	
450	Pampera 450	08-13				
450	Wild HP 450	03-05	ESTZ7S 54,90 €	YTZ7S 162,90 €	YTZ7S 43,90 €	F4977 69,30 €
515	EC515 FSR	08-09				
HM						
50	CRE50 Baja	97-00				
50	CRE50 Baja	07-16				
50	CRE50 Enduro	98-06				
50	CRE50 Six Compétition	07-16				
50	CRM50 Dérapage	07-16				
50	CRM50 Six Compétition	07-16				
125	CR125 Supermotard	04-06				
125	CRE125 Enduro	95-06				
125	CRE125 Supermotard	03-12				
125	CRM125 Dérapage 2T	11-16				
125	CRM125 F 4T	11-16				
125	CRM125 X Supermotard	07-13				
230	CRF230 Easy	04-06	ESTX5L-BS CTX5L(FA) 35,95 € 40,20 €	YTX5L-BS YTX5L(FA) 64,80 € 70,90 €	YTX5L-BS YTX5L(FA) 24,10 € 34,90 €	
250	CRE250 Enduro	95-06				
250	CRE250 F Enduro	04-04				
250	CRE250 F Enduro	05-06				
450	CRE450 F Enduro	02-05				
HONDA						
50	CRF50	04-14				
50	XR50	00-03				
70	CRF70	04-13				
70	TRX70	86-87				
70	XR70 R	95-03				
80	CR80 R	80-85				
80	CR80 R	86-02				
80	CRF80	04-09				
80	XR80	79-90				
80	XRR80	85-91				
85	CR85	03-08				
90	TRX90 Fourtrax	93-94				
90	TRX90 Fourtrax	95-98				
100	CRF100	04-13				







CATALOGUE ÉLECTRIQUE : Schémas, visuels, spécification et applications

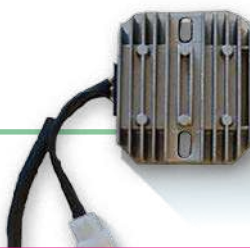

Cyl	Modèle	Année	 Skirich	€ T.T.C.	 STANDARD	€ T.T.C.	 IRIIDIUM	€ T.T.C.
GAS GAS								
320	TX320	97-99			BPR5ES	5,86 €	BPR5EIX	29,40 €
350	EC350F	21-22	HJTZ5S-FP	77,10 €			LMAR9AI8	42,16 €
350	JT35 350	95-95			BPR6ES	6,05 €	BPR6EIX	28,00 €
350	MC350F	22-22	HJTZ5S-FP	77,10 €			LMAR9AI8	42,16 €
370	Pampera 370	96-99	HJTX5L-FP HJTZ5S-FP	55,10 € 77,10 €	BPR6ES	6,05 €	BPR6EIX	28,00 €
400	EC400 FSE	02-09	HJTZ7S-FP HJTZ7S-FPZ	99,20 € 164,30 €	CR8E	13,85 €	CR8EIX	26,35 €
400	Pampera 400	05-09			CR8E	13,85 €	CR8EIX	26,35 €
450	EC450 FSE	99-01			CR8E	13,85 €	CR8EIX	26,35 €
450	EC450 FSE	02-06	HJTZ7S-FP HJTZ7S-FPZ	99,20 € 164,30 €	CR8E	13,85 €	CR8EIX	26,35 €
450	EC450 FSR	07-14			CR8E	13,85 €	CR8EIX	26,35 €
450	MC450F	21-22	HJTZ5S-FP	77,10 €	LMAR9AI8	42,16 €		
450	Pampera 450	08-13			CR8E	13,85 €	CR8EIX	26,35 €
450	Wild HP 450	03-05	HJTZ7S-FP HJTZ7S-FPZ	99,20 € 164,30 €	CR8E	13,85 €	CR8EIX	26,35 €
515	EC515 FSR	08-09			CR8E	13,85 €	CR8EIX	26,35 €
HM								
50	CRE50 Baja	97-00			B8ES	4,70 €	BR8EIX	26,75 €
50	CRE50 Baja	07-16			BR9ES	6,76 €	BR9EIX	26,35 €
50	CRE50 Enduro	98-06			B8ES	4,70 €	BR8EIX	26,75 €
50	CRE50 Six Compétition	07-16			BR9ES	6,76 €	BR9EIX	26,35 €
50	CRM50 Dérapage	07-16			BR9ES	6,76 €	BR9EIX	26,35 €
50	CRM50 Six Compétition	07-16			BR9ES	6,76 €	BR9EIX	26,35 €
125	CR125 Supermotard	04-06			BR9EG	14,65 €		
125	CRE125 Enduro	95-06			BR9EG	14,65 €		
125	CRE125 Supermotard	03-12			BR9EG	14,65 €		
125	CRM125 Dérapage 2T	11-16			BR9EG	14,65 €		
125	CRM125 F 4T	11-16			CR7E	14,10 €	CR7EIX	27,35 €
125	CRM125 X Supermotard	07-13			BR9EG	14,65 €		
230	CRF230 Easy	04-06	HJTX5L-FP HJTZ5S-FP	55,10 € 77,10 €	CR9EH9	19,45 €	CR9EHIX9	26,35 €
250	CRE250 Enduro	95-06			BR8EG	14,05 €		
250	CRE250 F Enduro	04-04			IMR8C9H	43,50 €	IMR8C9H	43,50 €
250	CRE250 F Enduro	05-06			R0409B8	94,66 €		
450	CRE450 F Enduro	02-05			IFR8H11	43,50 €		
HONDA								
50	CRF50	04-14			CR6HSA	7,20 €	CR6HIX	26,86 €
50	XR50	00-03			CR6HSA	7,20 €	CR6HIX	26,86 €
70	CRF70	04-13			CR6HSA	7,20 €	CR6HIX	26,86 €
70	TRX70	86-87			CR7HS	6,65 €	CR7HIX	26,86 €
70	XR70 R	95-03			CR6HSA	7,20 €	CR6HIX	26,86 €
80	CR80 R	80-85			BR9ES	6,76 €	BR9EIX	26,35 €
80	CR80 R	86-02			BR10EG	15,10 €		
80	CRF80	04-09			CR7HS	6,65 €	CR7HIX	26,86 €
80	XR80	79-90			CR7HSA	6,85 €	CR7HIX	26,86 €
80	XRR80	85-91			CR7HSA	6,85 €	CR7HIX	26,86 €
85	CR85	03-08			BR10EG	15,10 €		
90	TRX90 Fourtrax	93-94			CR6HSA	7,20 €	CR6HIX	26,86 €
90	TRX90 Fourtrax	95-98			CR7HSA	6,85 €	CR7HIX	26,86 €
100	CRF100	04-13			CR7HSA	6,85 €	CR7HIX	26,86 €

En ligne, moraco.fr/moraco/documents.



Cyl	Modèle	Année		€ T.T.C.		€ T.T.C.		€ T.T.C.		€ T.T.C.
HONDA										
100	XRR100	85-04								
125	CR125 R	87-07								
125	CRF125 F	14-21								
150	CRF150 F	03-06								
150	CRF150 F	07-14	ESTX5L-BS CTX5L(FA)	35,95 € 40,20 €	YTX5L-BS YTX5L(FA)	64,80 € 70,90 €	YTX5L-BS YTX5L(FA)	24,10 € 34,90 €		
150	CRF150 R (17"/14")	07-15								
150	CRF150 RB (19"/16")	07-15								
200	TRX 200	84-84			Y48141627	157,40 €	CB14A-A2	63,60 €		
200	TRX200 (Type2)	97-97			Y48141627	157,40 €	CB14A-A2	63,60 €		
230	CRF230 F	03-14	ESTX5L-BS CTX5L(FA)	35,95 € 40,20 €	YTX5L-BS YTX5L(FA)	64,80 € 70,90 €	YTX5L-BS YTX5L(FA)	24,10 € 34,90 €		
250	COTA 4T RT (Trial)	05-05								
250	CR250 R	88-08								
250	CRF250 R	04-04								
250	CRF250 R	05-09								
250	CRF250 R	10-17								
250	CRF250 R	18-18								
250	CRF250 R	19-21								
250	CRF250 R	22-22								
250	CRF250 RX	20-21								
250	CRF250 RX	22-22								
250	CRF250 X	04-07	ESTX5L-BS ESTZ7S	35,95 € 54,90 €	YTX5L-BS YTZ7S	64,80 € 162,90 €	YTX5L-BS YTZ7S	24,10 € 43,90 €		
250	CRF250 X	08-09	ESTX5L-BS ESTZ7S	35,95 € 54,90 €	YTX5L-BS YTZ7S	64,80 € 162,90 €	YTX5L-BS YTZ7S	24,10 € 43,90 €		
250	CRF250 X	10-15	ESTX5L-BS ESTZ7S	35,95 € 54,90 €	YTX5L-BS YTZ7S	64,80 € 162,90 €	YTX5L-BS YTZ7S	24,10 € 43,90 €		
250	TRX250 Fourtrax	02-19	ESTX14-BS CTX14(FA)	73,90 € 92,80 €	YTX14-BS YTX14(FA)	103,10 € 115,80 €	YTX14-BS YTX14(FA)	51,60 € 79,70 €		
250	TRX250 R	90-92	ESTX12-BS CTX12(FA)	68,90 € 81,80 €	YTX12-BS YTX12(FA)	80,10 € 90,00 €	YTX12-BS YTX12(FA)	45,30 € 67,70 €		
250	TRX250 Sportrax EX	01-08	ESTX9-BS CTX9(FA)	53,90 € 59,30 €	YTX9-BS YTX9(FA)	64,10 € 72,40 €	YTX9-BS YTX9(FA)	34,80 € 51,20 €		
250	TRX250 X	10-12	ESTX9-BS CTX9(FA)	53,90 € 59,30 €	YTX9-BS YTX9(FA)	64,10 € 72,40 €	YTX9-BS YTX9(FA)	34,80 € 51,20 €		
250	TRX250 X [US]	87-92	ESTX12-BS CTX12(FA)	68,90 € 81,80 €	YTX12-BS YTX12(FA)	80,10 € 90,00 €	YTX12-BS YTX12(FA)	45,30 € 67,70 €		
300	CRF300 RX	21-22								
300	TRX300 Sportrax EX	00-09	ESTX9-BS CTX9(FA)	53,90 € 59,30 €	YTX9-BS YTX9(FA)	64,10 € 72,40 €	YTX9-BS YTX9(FA)	34,80 € 51,20 €		
350	TRX350 FE /TE /FM	00-06	ESTX14-BS CTX14(FA)	73,90 € 92,80 €	YTX14-BS YTX14(FA)	103,10 € 115,80 €	YTX14-BS YTX14(FA)	51,60 € 79,70 €		
400	CRF400 RX	21-22								
400	TRX Foreman	95-03	ESTX14-BS CTX14(FA)	73,90 € 92,80 €	YTX14-BS YTX14(FA)	103,10 € 115,80 €	YTX14-BS YTX14(FA)	51,60 € 79,70 €		
400	TRX400 Fourtrax	99-99	ESTX9-BS CTX9(FA)	53,90 € 59,30 €	YTX9-BS YTX9(FA)	64,10 € 72,40 €	YTX9-BS YTX9(FA)	34,80 € 51,20 €		
400	TRX400 Fourtrax	00-09	ESTX9-BS CTX9(FA)	53,90 € 59,30 €	YTX9-BS YTX9(FA)	64,10 € 72,40 €	YTX9-BS YTX9(FA)	34,80 € 51,20 €		
400	TRX400 Sportrax	99-09	ESTX9-BS CTX9(FA)	53,90 € 59,30 €	YTX9-BS YTX9(FA)	64,10 € 72,40 €	YTX9-BS YTX9(FA)	34,80 € 51,20 €		
400	XR400 R	96-06								
400	XR400 Supermotard	96-06								
420	TRX420 Fourtrax	10-12	ESTX14-BS CTX14(FA)	73,90 € 92,80 €	YTX14-BS YTX14(FA)	103,10 € 115,80 €	YTX14-BS YTX14(FA)	51,60 € 79,70 €		
450	CRF450 R	02-04								
450	CRF450 R	05-08								
450	CRF450 R	09-16								







CATALOGUE ÉLECTRIQUE : Schémas, visuels, spécification et applications

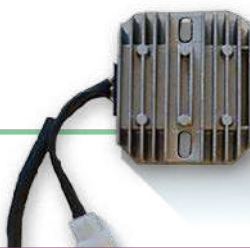

Cyl	Modèle	Année	Skorich	€ T.T.C.	STANDARD	€ T.T.C.	IRIDIUM	€ T.T.C.
HONDA								
100	XRR100	85-04			CR7HSA	6,85 €	CR7HIX	26,86 €
125	CR125 R	87-07			BR9EG	14,65 €	BR9EIX	26,35 €
125	CRF125 F	14-21			CPR6EA9	13,80 €		
150	CRF150 F	03-06			CR8EH9	18,70 €	CR8EHIX9	26,30 €
150	CRF150 F	07-14	HJTX5L-FP HJTZ5S-FP	55,10 € 77,10 €	R0409B9	69,76 €		
150	CRF150 R (17"/14")	07-15			R0409B9	69,76 €		
150	CRF150 RB (19"/16")	07-15			R0409B9	69,76 €		
200	TRX 200	84-84	HJTX14AHQ-FP	175,30 €				
200	TRX200 (Type2)	97-97	HJTX14AHQ-FP	175,30 €				
230	CRF230 F	03-14	HJTX5L-FP HJTZ5S-FP	55,10 € 77,10 €	DPR8EA9	6,65 €	DPR8EIX9	28,06 €
250	COTA 4T RT (Trial)	05-05			CR6EH9	19,70 €		
250	CR250 R	88-08			BR8EG	14,05 €		
250	CRF250 R	04-04			IMR8C9H	43,50 €		
250	CRF250 R	05-09			R0409B8	94,66 €		
250	CRF250 R	10-17			R0451B8	69,80 €		
250	CRF250 R	18-18	LFP01	99,20 €	R0451B8	69,80 €		
250	CRF250 R	19-21	LFP01	99,20 €	R0451B9	-		
250	CRF250 R	22-22	LFP01	99,20 €	SILMAR9A9S	44,35 €		
250	CRF250 RX	20-21	LFP01	99,20 €	R0451B9	-		
250	CRF250 RX	22-22	LFP01	99,20 €	SILMAR9A9S	44,35 €		
250	CRF250 X	04-07	HJTZ7S-FP HJTZ7S-FPZ	99,20 € 164,30 €	IMR8C9H	43,50 €		
250	CRF250 X	08-09	HJTZ7S-FP HJTZ7S-FPZ	99,20 € 164,30 €	R0409B8	94,66 €		
250	CRF250 X	10-15	HJTZ7S-FP HJTZ7S-FPZ	99,20 € 164,30 €	R0451B8	69,80 €		
250	TRX250 Fourtrax	02-19	HJTX14H-FP	109,90 €	DPR8EA9	6,65 €	DPR8EIX9	28,06 €
250	TRX250 R	90-92	HJTX14H-FP	109,90 €				
250	TRX250 Sportrax EX	01-08	HJTX9-FP	93,70 €	DPR8EA9	6,65 €	DPR8EIX9	28,06 €
250	TRX250 X	10-12	HJTX9-FP	93,70 €	DPR8EA9	6,65 €	DPR8EIX9	28,06 €
250	TRX250 X [US]	87-92	HJTX14H-FP	109,90 €				
300	CRF300 RX	21-22	LFP01	99,20 €	R0451B9	-		
300	TRX300 Sportrax EX	00-09	HJTX9-FP	93,70 €	DR8ESL	6,65 €	DR8EIX	26,35 €
350	TRX350 FE /TE /FM	00-06	HJTX14H-FP	109,90 €	DPR7EA9	6,65 €	DPR7EIX9	27,30 €
400	CRF400 RX	21-22	LFP01	99,20 €	SILMAR9A9S	44,35 €		
400	TRX Foreman	95-03	HJTX14H-FP	109,90 €				
400	TRX400 Fourtrax	99-99	HJTX9-FP	93,70 €	DPR7EA9	6,65 €	DPR7EIX9	27,30 €
400	TRX400 Fourtrax	00-09	HJTX9-FP	93,70 €	DPR8Z	14,10 €		
400	TRX400 Sportrax	99-09	HJTX9-FP	93,70 €	DPR8Z	14,10 €		
400	XR400 R	96-06			DPR8Z	14,10 €		
400	XR400 Supermotard	96-06			DPR8Z	14,10 €		
420	TRX420 Fourtrax	10-12	HJTX14H-FP	109,90 €	BKR5E11	5,80 €		
450	CRF450 R	02-04			IFR8H11	43,50 €	IFR8H11	43,50 €
450	CRF450 R	05-08			IFR9H11	42,50 €	IFR8H11	43,50 €
450	CRF450 R	09-16			SILMAR9A9S	44,35 €		

En ligne, moraco.fr/moraco/documents.



Cyl	Modèle	Année	 € T.T.C.	 € T.T.C.	 € T.T.C.	 € T.T.C.
HONDA						
450	CRF450 R	17-17	ESTX4L-BS CTX4L(FA) 28,90 € 30,90 €	YTX4L-BS YTX4L(FA) 36,30 € 39,40 €	YTX4L-BS YTX4L(FA) 17,80 € 25,60 €	
450	CRF450 R	18-21				
450	CRF450 R	22-22				
450	CRF450 RX	17-17	ESTX4L-BS CTX4L(FA) 28,90 € 30,90 €	YTX4L-BS YTX4L(FA) 36,30 € 39,40 €	YTX4L-BS YTX4L(FA) 17,80 € 25,60 €	
450	CRF450 RX	18-21				
450	CRF450 RX	22-22				
450	CRF450 X	05-08	ESTZ7S 54,90 €	YTZ7S 162,90 €	YTZ7S 43,90 €	F4977 69,30 €
450	CRF450 X	09-20	ESTZ7S 54,90 €	YTZ7S 162,90 €	YTZ7S 43,90 €	F4977 69,30 €
450	TRX450 Foreman	98-04	ESTX14-BS CTX14(FA) 73,90 € 92,80 €	YTX14-BS YTX14(FA) 103,10 € 115,80 €	YTX14-BS YTX14(FA) 51,60 € 79,70 €	
450	TRX450 R	04-09	ESTZ7S 54,90 €	YTZ7S 162,90 €	YTZ7S 43,90 €	F4977 69,30 €
450	TRX450 Sportrax	01-09	ESTX14-BS CTX14(FA) 73,90 € 92,80 €	YTX14-BS YTX14(FA) 103,10 € 115,80 €	YTX14-BS YTX14(FA) 51,60 € 79,70 €	
480	CR480 R	82-83				
500	CR500 R	84-02				
500	TRX500 FA Foretrax, Foreman	00-13	ESTX14-BS CTX14(FA) 73,90 € 92,80 €	YTX14-BS YTX14(FA) 103,10 € 115,80 €	YTX14-BS YTX14(FA) 51,60 € 79,70 €	
500	XR500 R	81-86				
500	XR500 S	79-80				
600	XR600 R	85-00				
650	Fourtrax650	04-04	ESTX14-BS CTX14(FA) 73,90 € 92,80 €	YTX14-BS YTX14(FA) 103,10 € 115,80 €	YTX14-BS YTX14(FA) 51,60 € 79,70 €	
650	TRX650 FA/FGA Rincon	03-05	ESTX14-BS CTX14(FA) 73,90 € 92,80 €	YTX14-BS YTX14(FA) 103,10 € 115,80 €	YTX14-BS YTX14(FA) 51,60 € 79,70 €	
650	XR650 L [US]	93-13	ESTX9-BS CTX9(FA) 53,90 € 59,30 €	YTX9-BS YTX9(FA) 64,10 € 72,40 €	YTX9-BS YTX9(FA) 34,80 € 51,20 €	
650	XR650 R	00-04	ESTX9-BS CTX9(FA) 53,90 € 59,30 €	YTX9-BS YTX9(FA) 64,10 € 72,40 €	YTX9-BS YTX9(FA) 34,80 € 51,20 €	
650	XR650 R	05-07				
680	TRX680 FA	06-09	ESTX20L-BS 100,90 €	YTX20L-BS YTX20L(FA) 154,10 € 173,60 €	YTX20L-BS YTX20L(FA) 77,90 € 96,90 €	
HUSABERG						
350	FE350 /E	96-99	ESTX9-BS CTX9(FA) 53,90 € 59,30 €	YTX9-BS YTX9(FA) 64,10 € 72,40 €	YTX9-BS YTX9(FA) 34,80 € 51,20 €	
390	FE390 Enduro	10-12	ESTZ7S 54,90 €	YTZ7S 162,90 €	YTZ7S 43,90 €	F4977 69,30 €
400	FC400	96-00	ESTX9-BS CTX9(FA) 53,90 € 59,30 €	YTX9-BS YTX9(FA) 64,10 € 72,40 €	YTX9-BS YTX9(FA) 34,80 € 51,20 €	
400	FE400 /S /E	96-99	ESTZ7S 54,90 €	YTZ7S 162,90 €	YTZ7S 43,90 €	F4977 69,30 €
400	FE400 /S /E	00-03	ESTZ7S 54,90 €	YTZ7S 162,90 €	YTZ7S 43,90 €	F4977 69,30 €
450	FC450	04-06	ESTZ7S 54,90 €	YTZ7S 162,90 €	YTZ7S 43,90 €	F4977 69,30 €
450	FE450	09-14	ESTZ7S 54,90 €	YTZ7S 162,90 €	YTZ7S 43,90 €	F4977 69,30 €
450	FE450 E	04-08	ESTZ7S 54,90 €	YTZ7S 162,90 €	YTZ7S 43,90 €	F4977 69,30 €
450	FS450 E /C	03-08	ESTZ7S 54,90 €	YTZ7S 162,90 €	YTZ7S 43,90 €	F4977 69,30 €
470	FC470	01-02	ESTX9-BS CTX9(FA) 53,90 € 59,30 €	YTX9-BS YTX9(FA) 64,10 € 72,40 €	YTX9-BS YTX9(FA) 34,80 € 51,20 €	
501	FC501	94-00	ESTX9-BS CTX9(FA) 53,90 € 59,30 €	YTX9-BS YTX9(FA) 64,10 € 72,40 €	YTX9-BS YTX9(FA) 34,80 € 51,20 €	
501	FE501	13-14	ESTZ7S 54,90 €	YTZ7S 162,90 €	YTZ7S 43,90 €	F4977 69,30 €
501	FE501 /S /E	00-04	ESTZ7S 54,90 €	YTZ7S 162,90 €	YTZ7S 43,90 €	F4977 69,30 €
501	TE 501	95-99	ESTX9-BS CTX9(FA) 53,90 € 59,30 €	YTX9-BS YTX9(FA) 64,10 € 72,40 €	YTX9-BS YTX9(FA) 34,80 € 51,20 €	







CATALOGUE ÉLECTRIQUE : Schémas, visuels, spécification et applications

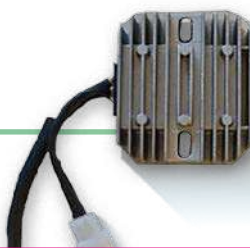

Cyl	Modèle	Année	Skriich		NGK STANDARD		NGK IRIIDIUM	
				€ T.T.C.		€ T.T.C.		€ T.T.C.
HONDA								
450	CRF450 R	17-17	HJTX5L-FP HJTZ5S-FP	55,10 € 77,10 €	SILMAR9A9S	44,35 €		
450	CRF450 R	18-21	LFP01	99,20 €	SILMAR9A9S	44,35 €		
450	CRF450 R	22-22	LFP01	99,20 €	SILMAR10A9S	46,50 €		
450	CRF450 RX	17-17	HJTX5L-FP HJTZ5S-FP	55,10 € 77,10 €	SILMAR9A9S	44,35 €		
450	CRF450 RX	18-21	LFP01	99,20 €	SILMAR9A9S	44,35 €		
450	CRF450 RX	22-22	LFP01	99,20 €	SILMAR10A9S	46,50 €		
450	CRF450 X	05-08	HJTZ7S-FP HJTZ7S-FPZ	99,20 € 164,30 €	IFR8H11	43,50 €	IFR8H11	43,50 €
450	CRF450 X	09-20	HJTZ7S-FP HJTZ7S-FPZ	99,20 € 164,30 €	SILMAR9A9S	44,35 €		
450	TRX450 Foreman	98-04	HJTX14H-FP	109,90 €	DPR7EA9	6,65 €	DPR7EIX9	27,30 €
450	TRX450 R	04-09	HJTZ7S-FP HJTZ7S-FPZ	99,20 € 164,30 €	IFR8H11	43,50 €		
450	TRX450 Sportrax	01-09	HJTX14H-FP	109,90 €				
480	CR480 R	82-83			BR8EG	14,05 €		
500	CR500 R	84-02			BR8EG	14,05 €		
500	TRX500 FA Foretrax, Foreman	00-13	HJTX14H-FP	109,90 €	IJR7A9	40,81 €	IJR7A9	40,81 €
500	XR500 R	81-86			DPR8EA9	6,65 €	DPR8EIX9	28,06 €
500	XR500 S	79-80			DR8ESL	6,65 €	DR8EIX	26,35 €
600	XR600 R	85-00			DPR8EA9	6,65 €	DPR8EIX9	28,06 €
650	Fourtrax650	04-04	HJTX14H-FP	109,90 €	IFR5L11	50,05 €		
650	TRX650 FA/FGA Rincon	03-05	HJTX14H-FP	109,90 €	IFR5L11	50,05 €	IFR5L11	50,05 €
650	XR650 L [US]	93-13	HJTX9-FP	93,70 €	DPR8EA9	6,65 €	DPR8EIX9	28,06 €
650	XR650 R	00-04	HJTX9-FP	93,70 €	BKR7E11	6,65 €		
650	XR650 R	05-07			BKR8E11	7,40 €		
680	TRX680 FA	06-09	HJTX20HQ-FP	242,70 €	IFR5L11	50,05 €		
HUSABERG								
350	FE350 /E	96-99	HJTX9-FP	93,70 €	C8E	11,70 €	CR8EIX	26,35 €
390	FE390 Enduro	10-12	HJTZ7S-FP HJTZ7S-FPZ	99,20 € 164,30 €	LKAR8AI9	38,70 €	LKAR8AI9	38,70 €
400	FC400	96-00	HJTX9-FP	93,70 €	C8E	11,70 €	CR8EIX	26,35 €
400	FE400 /S /E	96-99	HJTZ7S-FP HJTZ7S-FPZ	99,20 € 164,30 €	C8E	11,70 €	CR8EIX	26,35 €
400	FE400 /S /E	00-03	HJTZ7S-FP HJTZ7S-FPZ	99,20 € 164,30 €	DCPR8E	11,86 €	DCPR8EIX	29,30 €
450	FC450	04-06	HJTZ7S-FP HJTZ7S-FPZ	99,20 € 164,30 €	DCPR8E	11,86 €	DCPR8EIX	29,30 €
450	FE450	09-14	HJTZ7S-FP HJTZ7S-FPZ	99,20 € 164,30 €	LKAR8AI9	38,70 €		
450	FE450 E	04-08	HJTZ7S-FP HJTZ7S-FPZ	99,20 € 164,30 €	DCPR8E	11,86 €	DCPR8EIX	29,30 €
450	FS450 E /C	03-08	HJTZ7S-FP HJTZ7S-FPZ	99,20 € 164,30 €	DCPR8E	11,86 €	DCPR8EIX	29,30 €
470	FC470	01-02	HJTX9-FP	93,70 €	DCPR8E	11,86 €	DCPR8EIX	29,30 €
501	FC501	94-00	HJTX9-FP	93,70 €	DCPR8E	11,86 €	DCPR8EIX	29,30 €
501	FE501	13-14	HJTZ7S-FP HJTZ7S-FPZ	99,20 € 164,30 €				
501	FE501 /S /E	00-04	HJTZ7S-FP HJTZ7S-FPZ	99,20 € 164,30 €	DCPR8E	11,86 €	DCPR8EIX	29,30 €
501	TE 501	95-99	HJTX9-FP	93,70 €	C8E	11,70 €	CR8EIX	26,35 €

En ligne, moraco.fr/moraco/documents.



Cyl	Modèle	Année	 € T.T.C.	 € T.T.C.	 € T.T.C.	 € T.T.C.
HUSABERG						
501	TE 501	00-00	ESTX9-BS CTX9(FA) 53,90 € 59,30 €	YTX9-BS YTX9(FA) 64,10 € 72,40 €	YTX9-BS YTX9(FA) 34,80 € 51,20 €	
550	FC550	01-03	ESTX9-BS CTX9(FA) 53,90 € 59,30 €	YTX9-BS YTX9(FA) 64,10 € 72,40 €	YTX9-BS YTX9(FA) 34,80 € 51,20 €	
550	FC550	04-06	ESTZ7S 54,90 €	YTZ7S 162,90 €	YTZ7S 43,90 €	F4977 69,30 €
550	FE550 /E	04-08	ESTZ7S 54,90 €	YTZ7S 162,90 €	YTZ7S 43,90 €	F4977 69,30 €
570	FE570 Enduro	09-12	ESTZ7S 54,90 €	YTZ7S 162,90 €	YTZ7S 43,90 €	F4977 69,30 €
600	FC600 (Motocross)	93-97	ESTX9-BS CTX9(FA) 53,90 € 59,30 €	YTX9-BS YTX9(FA) 64,10 € 72,40 €	YTX9-BS YTX9(FA) 34,80 € 51,20 €	
600	FC600 (Motocross)	98-00	ESTX9-BS CTX9(FA) 53,90 € 59,30 €	YTX9-BS YTX9(FA) 64,10 € 72,40 €	YTX9-BS YTX9(FA) 34,80 € 51,20 €	
600	FC600 (Supermoto)	93-00	ESTX9-BS CTX9(FA) 53,90 € 59,30 €	YTX9-BS YTX9(FA) 64,10 € 72,40 €	YTX9-BS YTX9(FA) 34,80 € 51,20 €	
600	FE600 /S /E	00-03	ESTZ7S 54,90 €	YTZ7S 162,90 €	YTZ7S 43,90 €	F4977 69,30 €
650	FE650 E	01-08	ESTZ7S 54,90 €	YTZ7S 162,90 €	YTZ7S 43,90 €	F4977 69,30 €
650	FS650 C /E	01-08	ESTZ7S 54,90 €	YTZ7S 162,90 €	YTZ7S 43,90 €	F4977 69,30 €
HUSQVARNA						
50	CR Junior 50	06-14				
50	Husky boy50	00-01				
50	TC 50	17-22				
50	TC 50 Mini	19-22				
50	WXE50	08-10				
65	CR 65	12-14				
65	TC 65	17-22				
85	TC 85 14/17	16-22				
85	TC 85 16/19	14-22				
85	TC85 14/17 Zoll	14-15				
125	CR125	92-00				
125	CR125	01-13				
125	Cross Country	91-91				
125	TC125 2T	13-22				
125	TE125 2T	13-16				
125	TE125 4T	10-14				
125	TX125 2T	17-19				
125	WR125	92-94				
125	WR125	95-99				
125	WR125	00-13				
125	WRE125	94-13	ESTX4L-BS CTX4L(FA) 28,90 € 30,90 €	YTX4L-BS YTX4L(FA) 36,30 € 39,40 €	YTX4L-BS YTX4L(FA) 17,80 € 25,60 €	
150	TE150i	20-22				
250	CR250	92-92				
250	CR250	93-94				
250	CR250	95-00				
250	CR250	01-05				
250	FC 250	14-16				
250	FC 250	17-18				
250	FC 250	19-22		YTZ5S 77,40 €		
250	FE250	14-16				
250	FE250	17-22		YTZ5S 77,40 €		
250	TC250	02-03	ESTX5L-BS CTX5L(FA) 35,95 € 40,20 €	YTX5L-BS YTX5L(FA) 64,80 € 70,90 €	YTX5L-BS YTX5L(FA) 24,10 € 34,90 €	







CATALOGUE ÉLECTRIQUE : Schémas, visuels, spécification et applications

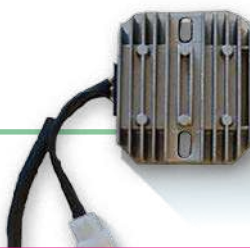

Cyl	Modèle	Année	Sk rich	€ T.T.C.	NGK STANDARD	€ T.T.C.	NGK IRIIDIUM	€ T.T.C.
HUSABERG								
501	TE 501	00-00	HJTX9-FP	93,70 €	DCPR8E	11,86 €	DCPR8EIX	29,30 €
550	FC550	01-03	HJTX9-FP	93,70 €	DCPR8E	11,86 €	DCPR8EIX	29,30 €
550	FC550	04-06	HJZ7S-FP HJZ7S-FPZ	99,20 € 164,30 €	DCPR8E	11,86 €	DCPR8EIX	29,30 €
550	FE550 /E	04-08	HJZ7S-FP HJZ7S-FPZ	99,20 € 164,30 €	DCPR8E	11,86 €	DCPR8EIX	29,30 €
570	FE570 Enduro	09-12	HJZ7S-FP HJZ7S-FPZ	99,20 € 164,30 €	LKAR8AI9	38,70 €		
600	FC600 (Motocross)	93-97	HJTX9-FP	93,70 €	DCPR8E	11,86 €	DCPR8EIX	29,30 €
600	FC600 (Motocross)	98-00	HJTX9-FP	93,70 €	C8E	11,70 €	CR8EIX	26,35 €
600	FC600 (Supersmoto)	93-00	HJTX9-FP	93,70 €	DCPR8E	11,86 €	DCPR8EIX	29,30 €
600	FE600 /S /E	00-03	HJZ7S-FP HJZ7S-FPZ	99,20 € 164,30 €	DCPR8E	11,86 €	DCPR8EIX	29,30 €
650	FE650 E	01-08	HJZ7S-FP HJZ7S-FPZ	99,20 € 164,30 €	DCPR8E	11,86 €	DCPR8EIX	29,30 €
650	FS650 C /E	01-08	HJZ7S-FP HJZ7S-FPZ	99,20 € 164,30 €	DCPR8E	11,86 €	DCPR8EIX	29,30 €
HUSQVARNA								
50	CR Junior 50	06-14			B10EGV BR9ES	18,98 € 6,76 €	BR9EIX	26,35 €
50	Husky boy50	00-01			B7HS	5,26 €	BR7HIX	26,86 €
50	TC 50	17-22			LR8B	16,10 €		
50	TC 50 Mini	19-22			LR8B	16,10 €		
50	WXE50	08-10			B9ES	5,35 €	BR9EIX	26,35 €
65	CR 65	12-14			BR8ECM	14,70 €	BR8ECMIX	26,86 €
65	TC 65	17-22			LR8B	16,10 €		
85	TC 85 14/17	16-22			BR9ECMIX	26,86 €		
85	TC 85 16/19	14-22			BR9ECMIX	26,86 €		
85	TC85 14/17 Zoll	14-15			BR9ECMIX	26,86 €		
125	CR125	92-00			B10EGV	18,98 €		
125	CR125	01-13			BR9EG	14,65 €		
125	Cross Country	91-91			B10EGV	18,98 €		
125	TC125 2T	13-22			BR9ECMIX	26,86 €		
125	TE125 2T	13-16			BR9ECMIX	26,86 €		
125	TE125 4T	10-14			CR8E	13,85 €	CR8EIX	26,35 €
125	TX125 2T	17-19			BR9ECMIX	26,86 €		
125	WR125	92-94			B9EGV	18,98 €		
125	WR125	95-99			B95EGV	18,98 €		
125	WR125	00-13			BR9EG	14,65 €		
125	WRE125	94-13	HJTX5L-FP HJZ5S-FP	55,10 € 77,10 €	B9EG	11,86 €		
150	TE150i	20-22			GR8DI12	-		
250	CR250	92-92			B9EGV	18,98 €		
250	CR250	93-94			B95EGV	18,98 €		
250	CR250	95-00			B9EGV	18,98 €		
250	CR250	01-05			BR8EG	14,05 €		
250	FC 250	14-16			LMAR9AI8	42,16 €		
250	FC 250	17-18	LFP01	99,20 €	LMAR9AI8	42,16 €		
250	FC 250	19-22	HJZ5S-FP	77,10 €	LMAR9AI8	42,16 €		
250	FE250	14-16			LMAR9AI10	35,35 €		
250	FE250	17-22	HJZ5S-FP	77,10 €	LMAR9AI10	35,35 €		
250	TC250	02-03	HJTX5L-FP HJZ5S-FP	55,10 € 77,10 €	CR8EB	13,60 €	CR8EIX	26,35 €

En ligne, moraco.fr/moraco/documents.



Cyl	Modèle	Année	 € T.T.C.	 € T.T.C.	 € T.T.C.	 € T.T.C.
HUSQVARNA						
250	TC250	04-10	ESTZ7S 54,90 €	YTZ7S 162,90 €	YTZ7S 43,90 €	F4977 69,30 €
250	TC250	11-12	ESTZ7S 54,90 €	YTZ7S 162,90 €	YTZ7S 43,90 €	F4977 69,30 €
250	TC250	13-17	ESTZ7S 54,90 €	YTZ7S 162,90 €	YTZ7S 43,90 €	F4977 69,30 €
250	TC250	18-22				
250	TE250	02-09	ESTZ7S 54,90 €	YTZ7S 162,90 €	YTZ7S 43,90 €	F4977 69,30 €
250	TE250	10-12	ESTZ7S 54,90 €	YTZ7S 162,90 €	YTZ7S 43,90 €	F4977 69,30 €
250	TE250	13-13	ESTZ7S 54,90 €	YTZ7S 162,90 €	YTZ7S 43,90 €	F4977 69,30 €
250	TE250	14-17				
250	TE250i	18-19		YTZ5S 77,40 €		
250	TE250i	20-22		YTZ5S 77,40 €		
250	WR250	92-95				
250	WR250	96-98				
250	WR250	99-13				
260	WR260	90-90				
300	TE300	14-17				
300	TE300i	18-19		YTZ5S 77,40 €		
300	TE300i	20-22		YTZ5S 77,40 €		
300	WR300	09-13				
310	TE310	08-08				
310	TE310	09-13	ESTZ7S 54,90 €	YTZ7S 162,90 €	YTZ7S 43,90 €	F4977 69,30 €
350	FC 350	14-16				
350	FC 350	16-17				
350	FC 350	18-22		YTZ5S 77,40 €		
350	FE 350	14-17				
350	FE 350	18-22				
350	TE350	90-96	ESTZ7S 54,90 €	YTZ7S 162,90 €	YTZ7S 43,90 €	F4977 69,30 €
350	TE350	97-99				
360	WR360	92-00				
360	WR360	01-02				
400	TE400	98-02				
410	TE410	96-01				
449	TC449	11-13				
449	TE449	11-13				
450	FC 450	14-15				
450	FC 450	16-16				
450	FC 450	17-17				
450	FC 450	18-22		YTZ5S 77,40 €		
450	FE 450	14-16				
450	FE 450	17-17				
450	FE 450	18-19		YTZ5S 77,40 €		
450	FE 450	20-22		YTZ5S 77,40 €		
450	FS 450	15-17				
450	FS 450	18-22		YTZ5S 77,40 €		
450	QM450	07-08				







CATALOGUE ÉLECTRIQUE : Schémas, visuels, spécification et applications

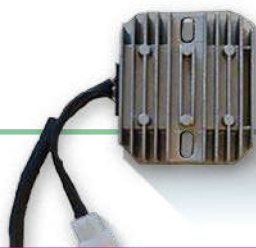

Cyl	Modèle	Année	Sk rich	€ T.T.C.	NGK STANDARD	€ T.T.C.	NGK IRIDIUM	€ T.T.C.
HUSQVARNA								
250	TC250	04-10	HJTZ7S-FP HJTZ7S-FPZ	99,20 € 164,30 €	CR8EB	13,60 €	CR8EIX	26,35 €
250	TC250	11-12	HJTZ7S-FP HJTZ7S-FPZ	99,20 € 164,30 €	CR9EB	14,10 €	CR9EIX	26,35 €
250	TC250	13-17	HJTZ7S-FP HJTZ7S-FPZ	99,20 € 164,30 €	BR8ECM	14,70 €	BR8ECMIX	26,86 €
250	TC250	18-22			BR8ECM	14,70 €	BR8ECMIX	26,86 €
250	TE250	02-09	HJTZ7S-FP HJTZ7S-FPZ	99,20 € 164,30 €	CR8EB	13,60 €	CR8EIX	26,35 €
250	TE250	10-12	HJTZ7S-FP HJTZ7S-FPZ	99,20 € 164,30 €	CR9EB	14,10 €	CR9EIX	26,35 €
250	TE250	13-13	HJTZ7S-FP HJTZ7S-FPZ	99,20 € 164,30 €	BR7ES	7,06 €	BR7EIX	26,86 €
250	TE250	14-17			BR7ES	7,06 €	BR7EIX	26,86 €
250	TE250i	18-19	HJTZ5S-FP HJTZ7S-FP	77,10 € 99,20 €	ZGR7G113G	-		
250	TE250i	20-22	HJTZ5S-FP HJTZ7S-FP	77,10 € 99,20 €	BR7ES	7,06 €		
250	WR250	92-95			B9EGV	18,98 €		
250	WR250	96-98			B9EG	11,86 €		
250	WR250	99-13			B8EG	11,95 €		
260	WR260	90-90			B9EGV	18,98 €		
300	TE300	14-17			BR7ES	7,06 €		
300	TE300i	18-19	HJTZ5S-FP HJTZ7S-FP	77,10 € 99,20 €	ZGR7G113G	-		
300	TE300i	20-22	HJTZ5S-FP HJTZ7S-FP	77,10 € 99,20 €	BR7ES	7,06 €		
300	WR300	09-13			BR8EG	14,05 €		
310	TE310	08-08			CR9EB	14,10 €	CR9EIX	26,35 €
310	TE310	09-13	HJTZ7S-FP HJTZ7S-FPZ	99,20 € 164,30 €	CR9EB	14,10 €	CR9EIX	26,35 €
350	FC 350	14-16			LMAR9AI8	42,16 €		
350	FC 350	16-17	LFP01	99,20 €	LMAR9AI8	42,16 €		
350	FC 350	18-22	HJTZ5S-FP	77,10 €	LMAR9AI8	42,16 €		
350	FE 350	14-17			LMAR9AI8	42,16 €		
350	FE 350	18-22	HJTZ5S-FP	77,10 €	LMAR9AI8	42,16 €		
350	TE350	90-96	HJTZ7S-FP HJTZ7S-FPZ	99,20 € 164,30 €	C7E	11,70 €	CR7EIX	27,35 €
350	TE350	97-99			C7E	11,70 €		
360	WR360	92-00			B8EG	11,95 €		
360	WR360	01-02			B8EGV	18,98 €		
400	TE400	98-02			C7E	11,70 €	CR8EIX	26,35 €
410	TE410	96-01			C7E	11,70 €	CR7EIX	27,35 €
449	TC449	11-13			CR9EKB	20,50 €	CR9EIX	26,35 €
449	TE449	11-13			CR9EKB	20,50 €	CR9EIX	26,35 €
450	FC 450	14-15			LKAR8AI9	38,70 €		
450	FC 450	16-16	LFP01	99,20 €	LKAR8AI9	38,70 €		
450	FC 450	17-17	LFP01	99,20 €	LMAR9AI8	42,16 €		
450	FC 450	18-22	HJTZ5S-FP	77,10 €	LMAR9AI8	42,16 €		
450	FE 450	14-16			LKAR8AI9	38,70 €		
450	FE 450	17-17			LMAR9AI10	35,35 €		
450	FE 450	18-19	HJTZ5S-FP	77,10 €	LMAR9AI10	35,35 €		
450	FE 450	20-22	HJTZ5S-FP	77,10 €	LZMAR8BI10	-		
450	FS 450	15-17			LKAR8AI9	38,70 €		
450	FS 450	18-22	HJTZ5S-FP	77,10 €	LKAR8AI9	38,70 €		
450	QM450	07-08			CR8EB	13,60 €	CR8EIX	26,35 €

En ligne, moraco.fr/moraco/documents.



Cyl	Modèle	Année	 € T.T.C.	 € T.T.C.	 € T.T.C.	 € T.T.C.
HUSQVARNA						
450	TC450	02-14	ESTZ7S 54,90 €	YTZ7S 162,90 €	YTZ7S 43,90 €	F4977 69,30 €
450	TE450	02-13	ESTZ7S 54,90 €	YTZ7S 162,90 €	YTZ7S 43,90 €	F4977 69,30 €
500	CR 500	84-86				
500	XC 500	87-87				
501	FE 501	14-16				
501	FE 501	17-17				
501	FE 501	18-19		YTZ5S 77,40 €		
501	FE 501	20-22		YTZ5S 77,40 €		
510	510	87-89				
510	SM510 Centennial	06-07	ESTZ7S 54,90 €	YTZ7S 162,90 €	YTZ7S 43,90 €	F4977 69,30 €
510	SMR510	04-12	ESTZ7S 54,90 €	YTZ7S 162,90 €	YTZ7S 43,90 €	F4977 69,30 €
510	TC510	02-12	ESTZ7S 54,90 €	YTZ7S 162,90 €	YTZ7S 43,90 €	F4977 69,30 €
510	TE510	88-91	ESTZ7S 54,90 €	YTZ7S 162,90 €	YTZ7S 43,90 €	F4977 69,30 €
510	TE510	02-10	ESTZ7S 54,90 €	YTZ7S 162,90 €	YTZ7S 43,90 €	F4977 69,30 €
510	TE510	11-13	ESTZ7S 54,90 €	YTZ7S 162,90 €	YTZ7S 43,90 €	F4977 69,30 €
510	TE510 Centennial	04-07	ESTZ7S 54,90 €	YTZ7S 162,90 €	YTZ7S 43,90 €	F4977 69,30 €
570	TC570	01-02	ESTX5L-BS 35,95 € CTX5L(FA) 40,20 €	YTX5L-BS 64,80 € YTX5L(FA) 70,90 €	YTX5L-BS 24,10 € YTX5L(FA) 34,90 €	
570	TC570	03-13				
570	TE570	01-03	ESTX5L-BS 35,95 € CTX5L(FA) 40,20 €	YTX5L-BS 64,80 € YTX5L(FA) 70,90 €	YTX5L-BS 24,10 € YTX5L(FA) 34,90 €	
570	TE570	04-13				
610	TC610	92-02	ESTX5L-BS 35,95 € CTX5L(FA) 40,20 €	YTX5L-BS 64,80 € YTX5L(FA) 70,90 €	YTX5L-BS 24,10 € YTX5L(FA) 34,90 €	
610	TC610	03-05				
610	TC610	06-13				
610	TC610 Cross	91-91				
610	TE610	92-02	ESTX5L-BS 35,95 € CTX5L(FA) 40,20 €	YTX5L-BS 64,80 € YTX5L(FA) 70,90 €	YTX5L-BS 24,10 € YTX5L(FA) 34,90 €	
610	TE610	03-05				
610	TE610	06-09				
610	TE610 E	97-99				
610	TE610 E	00-05	ESTX14-BS 73,90 € CTX14(FA) 92,80 €	YTX14-BS 103,10 € YTX14(FA) 115,80 €	YTX14-BS 51,60 € YTX14(FA) 79,70 €	
610	TE610 E	06-06	ESTX14-BS 73,90 € CTX14(FA) 92,80 €	YTX14-BS 103,10 € YTX14(FA) 115,80 €	YTX14-BS 51,60 € YTX14(FA) 79,70 €	
610	TE610 E	07-13				
610	TE610 i.e.	08-10	ESTZ7S 54,90 €	YTZ7S 162,90 €	YTZ7S 43,90 €	F4977 69,30 €
630	TE630	10-12				
693	Enduro 701	16-22				
HYOSUNG						
450	TE450 Sport	07-09	ESTX9-BS 53,90 € CTX9(FA) 59,30 €	YTX9-BS 64,10 € YTX9(FA) 72,40 €	YTX9-BS 34,80 € YTX9(FA) 51,20 €	
KAWASAKI						
50	KFX50 (KSF [US])	02-09				
60	KX60	83-92				
60	KX60	93-99				
65	KX65	00-18				
80	KFX80 (KSF[US])	03-06	ESTX5L-BS 35,95 € CTX5L(FA) 40,20 €	YTX5L-BS 64,80 € YTX5L(FA) 70,90 €	YTX5L-BS 24,10 € YTX5L(FA) 34,90 €	







CATALOGUE ÉLECTRIQUE : Schémas, visuels, spécification et applications

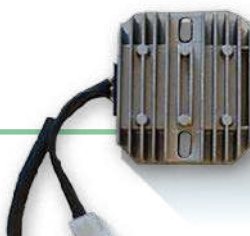

Cyl	Modèle	Année	Skriich	€ T.T.C.	NGK STANDARD	€ T.T.C.	NGK IRIDIUM	€ T.T.C.
HUSQVARNA								
450	TC450	02-14	HJTZ7S-FP HJTZ7S-FPZ	99,20 € 164,30 €	CR8EB	13,60 €	CR8EIX	26,35 €
450	TE450	02-13	HJTZ7S-FP HJTZ7S-FPZ	99,20 € 164,30 €	CR8EB	13,60 €	CR8EIX	26,35 €
500	CR 500	84-86			B8EG	11,95 €		
500	XC 500	87-87			B8EG	11,95 €		
501	FE 501	14-16			LKAR8AI9	38,70 €		
501	FE 501	17-17			LMAR9AI10	35,35 €		
501	FE 501	18-19	HJTZ5S-FP	77,10 €	LMAR9AI10	35,35 €		
501	FE 501	20-22	HJTZ5S-FP	77,10 €	LZMAR8BI10	-		
510	510	87-89			C7E	11,70 €	CR7EIX	27,35 €
510	SM510 Centennial	06-07	HJTZ7S-FP HJTZ7S-FPZ	99,20 € 164,30 €	CR8EB	13,60 €	CR8EIX	26,35 €
510	SMR510	04-12	HJTZ7S-FP HJTZ7S-FPZ	99,20 € 164,30 €	CR8EB	13,60 €	CR8EIX	26,35 €
510	TC510	02-12	HJTZ7S-FP HJTZ7S-FPZ	99,20 € 164,30 €	CR8EB	13,60 €	CR8EIX	26,35 €
510	TE510	88-91	HJTZ7S-FP HJTZ7S-FPZ	99,20 € 164,30 €	C7E	11,70 €	CR7EIX	27,35 €
510	TE510	02-10	HJTZ7S-FP HJTZ7S-FPZ	99,20 € 164,30 €	CR8EB	13,60 €	CR8EIX	26,35 €
510	TE510	11-13	HJTZ7S-FP HJTZ7S-FPZ	99,20 € 164,30 €	CR8EB	13,60 €		
510	TE510 Centennial	04-07	HJTZ7S-FP HJTZ7S-FPZ	99,20 € 164,30 €	CR8EB	13,60 €	CR8EIX	26,35 €
570	TC570	01-02	HJTX5L-FP HJTZ5S-FP	55,10 € 77,10 €	C7E	11,70 €	CR7EIX	27,35 €
570	TC570	03-13			CR7EB	13,66 €	CR7EIX	27,35 €
570	TE570	01-03	HJTX5L-FP HJTZ5S-FP	55,10 € 77,10 €	C7E	11,70 €	CR7EIX	27,35 €
570	TE570	04-13			C7E	11,70 €	CR7EIX	27,35 €
610	TC610	92-02	HJTX5L-FP HJTZ5S-FP	55,10 € 77,10 €	C7E	11,70 €	CR7EIX	27,35 €
610	TC610	03-05			C7E	11,70 €	CR7EIX	27,35 €
610	TC610	06-13			CPR8E	13,80 €		
610	TC610 Cross	91-91			C7E	11,70 €	CR7EIX	27,35 €
610	TE610	92-02	HJTX5L-FP HJTZ5S-FP	55,10 € 77,10 €	C7E	11,70 €	CR7EIX	27,35 €
610	TE610	03-05			C7E	11,70 €	CR7EIX	27,35 €
610	TE610	06-09			CPR8E	13,80 €		
610	TE610 E	97-99			C7E	11,70 €	CR7EIX	27,35 €
610	TE610 E	00-05	HJTX14H-FP	109,90 €	C7E	11,70 €	CR7EIX	27,35 €
610	TE610 E	06-06	HJTX14H-FP	109,90 €	CPR8E	13,80 €		
610	TE610 E	07-13			CPR8E	13,80 €		
610	TE610 i.e.	08-10	HJTZ7S-FP HJTZ7S-FPZ	99,20 € 164,30 €	CPR8E	13,80 €		
630	TE630	10-12			CR8EB	13,60 €	CR8EIX	26,35 €
693	Enduro 701	16-22			LKAR9BI10 LMRA7DI10	-		
HYOSUNG								
450	TE450 Sport	07-09	HJTX9-FP	93,70 €	CR8E	13,85 €	CR8EIX	26,35 €
KAWASAKI								
50	KFX50 (KSF [US])	02-09			BPR4HS	7,15 €		
60	KX60	83-92			B9EG	11,86 €		
60	KX60	93-99			BR9EG	14,65 €		
65	KX65	00-18			BR10EG	15,10 €		
80	KFX80 (KSF[US])	03-06	HJTX5L-FP HJTZ5S-FP	55,10 € 77,10 €	BPR4HS	7,15 €		

En ligne, moraco.fr/moraco/documents.



Cyl	Modèle	Année	 € T.T.C.	 € T.T.C.	 € T.T.C.	 € T.T.C.		
KAWASAKI								
80	KX80	89-91						
80	KX80	92-00						
85	KX85	01-22						
110	KLX110	02-21						
125	KDX125	88-94	ESB3L-A	23,70 €	Y3361			
125	KLX125 C	10-16	ESTX7L-BS CTX7L(FA)	49,60 € 52,90 €	YTX7L-BS YTX7L(FA)	70,50 € 75,20 €	YTX7L-BS YTX7L(FA)	33,40 € 47,30 €
125	KLX125 D D-Tracker	10-14	ESTX7L-BS CTX7L(FA)	49,60 € 52,90 €	YTX7L-BS YTX7L(FA)	70,50 € 75,20 €	YTX7L-BS YTX7L(FA)	33,40 € 47,30 €
125	KX125	82-85						
125	KX125	86-89						
125	KX125	90-90						
125	KX125	91-91						
125	KX125	92-94						
125	KX125	95-96						
125	KX125	97-97						
125	KX125	98-99						
125	KX125	00-03						
200	KDX200	92-94	ESB3L-A	23,70 €	Y3361			
200	KDX200	95-95	ESB3L-A	23,70 €	Y3361			
200	KDX200	96-06	ESB3L-A	23,70 €	Y3361			
200	KLT 200	83-84	ESB12A-A	61,50 €	YB12A-A	74,80 €	CB12A-A	51,30 €
220	KLF220 Bayou	88-97						
220	KLF220 Bayou	98-98	ESB3L-A	23,70 €	Y3361			
220	KLF220 Bayou	99-03						
250	KDX250	91-97						
250	KFX250 Mojave (KSF [US])	87-04						
250	KLA 250	78-84			6N6-1D-2	28,10 €		
250	KLT 250	83-85	ESB12A-A	61,50 €	YB12A-A	74,80 €	CB12A-A	51,30 €
250	KLX250 R	93-98			YB4L-A	36,50 €		
250	KLX250 S /SF	09-17	ESTX7L-BS CTX7L(FA)	49,60 € 52,90 €	YTX7L-BS YTX7L(FA)	70,50 € 75,20 €	YTX7L-BS YTX7L(FA)	33,40 € 47,30 €
250	KSF Mojave	87-87						
250	KX250	82-85						
250	KX250	86-91						
250	KX250	92-93						
250	KX250	94-96						
250	KX250	97-04						
250	KX250	05-08						
250	KX250 F	04-05						
250	KX250 F	06-10						
250	KX250 F	11-18						
250	KX250 F - KX	19-19						
250	KX250 F - KX	20-22						
250	KX250X Enduro (KL)	22-22						
250	KX250 F Tecate quad	87-88						
300	KEF300 Lakota	95-03					CB14A-A2	63,60 €
300	KFX300 (KSF [US])	04-05						
300	KLF300 Bayou	86-87			YB16L-B			
300	KLF300 Bayou	88-07					CB14A-A2	63,60 €
300	KLX300 R	97-07						







CATALOGUE ÉLECTRIQUE : Schémas, visuels, spécification et applications

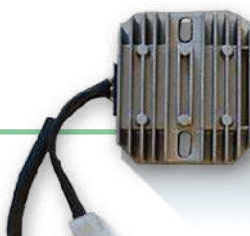

Cyl	Modèle	Année	Sk rich	€ T.T.C.	NGK STANDARD	€ T.T.C.	NGK IRIIDIUM	€ T.T.C.
KAWASAKI								
80	KX80	89-91			B9EG	11,86 €		
80	KX80	92-00			R6252K105	12,85 €		
85	KX85	01-22			R6252K105	12,85 €		
110	KLX110	02-21			CR6HSA	7,20 €	CR6HIX	26,86 €
125	KDX125	88-94			BR8ES	6,35 €	BR8EIX	26,75 €
125	KLX125 C	10-16	HJTZ7S-FP	99,20 €	CR7HSA	6,85 €	CR7HIX	26,86 €
125	KLX125 D D-Tracker	10-14	HJTZ7S-FP	99,20 €	CR7HSA	6,85 €	CR7HIX	26,86 €
125	KX125	82-85			BR9EIX	26,35 €	BR9EIX	26,35 €
125	KX125	86-89			BR10EIX	26,86 €	BR10EIX	26,86 €
125	KX125	90-90			R6254E105	13,15 €	BR10EIX	26,86 €
125	KX125	91-91			R6254E105	13,15 €		
125	KX125	92-94			R6252K105	12,85 €		
125	KX125	95-96			BR9EIX	26,35 €		
125	KX125	97-97			R6252K105	12,85 €		
125	KX125	98-99			BR9EIX	26,35 €		
125	KX125	00-03			BR9EIX	26,35 €	BR9EIX	26,35 €
200	KDX200	92-94			BR9ES	6,76 €	BR9EIX	26,35 €
200	KDX200	95-95			BR9ES	6,76 €	BR8EIX	26,75 €
200	KDX200	96-06			BR9ES	6,76 €	BR9EIX	26,35 €
200	KLT 200	83-84	HJTX14AHQ-FP	175,30 €	B7ES	5,45 €	BR7EIX	26,86 €
220	KLF220 Bayou	88-97			DR8ES	6,65 €	DR8EIX	26,35 €
220	KLF220 Bayou	98-98			DR8ES	6,65 €	DR8EIX	26,35 €
220	KLF220 Bayou	99-03			DR8ES	6,65 €	DR8EIX	26,35 €
250	KDX250	91-97			BR9ES	6,76 €	BR9EIX	26,35 €
250	KFX250 Mojave (KSF [US])	87-04			DPR8EA9	6,65 €	DPR8EIX9	28,06 €
250	KLA 250	78-84						
250	KLT 250	83-85	HJTX14AHQ-FP	175,30 €	B8ES	4,70 €	BR8EIX	26,75 €
250	KLX250 R	93-98	HJB5L-FP	66,10 €	CR8E	13,85 €	CR8EIX	26,35 €
250	KLX250 S /SF	09-17	HJTZ7S-FP	99,20 €	CR8E	13,85 €	CR8EIX	26,35 €
250	KSF Mojave	87-87			DP8EA9	5,95 €		
250	KX250	82-85			B8EG	11,95 €		
250	KX250	86-91			B9EG	11,86 €		
250	KX250	92-93			R6252E9	9,70 €		
250	KX250	94-96			BR8EIX	26,75 €		
250	KX250	97-04			BR8EIX	26,75 €	BR8EIX	26,75 €
250	KX250	05-08			BR8ECMIX	26,86 €		
250	KX250 F	04-05			CR8EB	13,60 €	CR8EIX	26,35 €
250	KX250 F	06-10			CR8E	13,85 €	CR8EIX	26,35 €
250	KX250 F	11-18			CPR8EB9	14,00 €		
250	KX250 F - KX	19-19			CPR8EB9	14,00 €		
250	KX250 F - KX	20-22			CR9EIB9	36,25 €		
250	KX250X Enduro (KL)	22-22			CR9EIB9	36,25 €		
250	KX250 F Tecate quad	87-88			B9EG	11,86 €	BR9EIX	26,35 €
300	KEF300 Lakota	95-03			DR8EA	6,76 €	DR8EIX	26,35 €
300	KFX300 (KSF [US])	04-05			DR7EA	6,95 €	DR7EIX	28,10 €
300	KLF300 Bayou	86-87	HJTX20HQ-FP	242,70 €	DR8EA	6,76 €	DR8EIX	26,35 €
300	KLF300 Bayou	88-07			DR8EA	6,76 €	DR8EIX	26,35 €
300	KLX300 R	97-07			CR8E	13,85 €	CR8EIX	26,35 €

En ligne, moraco.fr/moraco/documents.



Cyl	Modèle	Année	 € T.T.C.	 € T.T.C.	 € T.T.C.	 € T.T.C.	
KAWASAKI							
300	KVF300 4x4	12-19		YB16L-B			
360	KVF360 Prairie 2x4	03-09				CB14A-A2	63,60 €
360	KVF360 Prairie 4x4	03-13				CB14A-A2	63,60 €
400	KFX400 (KSF [US])	02-06	ESTX9-BS CTX9(FA) 53,90 € 59,30 €	YTX9-BS YTX9(FA) 64,10 € 72,40 €		YTX9-BS YTX9(FA)	34,80 € 51,20 €
400	KLF400 Bayou	93-99		YB16L-B			
400	KVF400 Prairie	97-98				CB14A-A2	63,60 €
400	KVF400 Prairie 2x4	99-02				CB14A-A2	63,60 €
400	KVF400 Prairie 4x4	99-02				CB14A-A2	63,60 €
450	KFX450 R	07-14	ESTX7L-BS CTX7L(FA) 49,60 € 52,90 €	YTX7L-BS YTX7L(FA) 70,50 € 75,20 €		YTX7L-BS YTX7L(FA)	33,40 € 47,30 €
450	KLX450 R	05-15	ESTZ7S 54,90 €	YTZ7S 162,90 €		YTZ7S	43,90 € F4977 69,30 €
450	KX450 F	06-18					
450	KX450 F - KX	19-22					
450	KX450 F Efi	09-16					
450	KX450 X Enduro (KL)	22-22					
500	KX500	84-04					
650	KFX650 V-Force	01-02	ESTX14-BS CTX14(FA) 73,90 € 92,80 €	YTX14-BS YTX14(FA) 103,10 € 115,80 €		YTX14-BS YTX14(FA)	51,60 € 79,70 €
650	KLX650 C	93-95	ESTX9-BS CTX9(FA) 53,90 € 59,30 €	YTX9-BS YTX9(FA) 64,10 € 72,40 €		YTX9-BS YTX9(FA)	34,80 € 51,20 €
650	KLX650 R	93-01	ESTX9-BS CTX9(FA) 53,90 € 59,30 €	YTX9-BS YTX9(FA) 64,10 € 72,40 €		YTX9-BS YTX9(FA)	34,80 € 51,20 €
650	KVF650 Brute Force 4x4i	05-14					
650	KVF650 Prairie	01-03					
700	KFX700 V-Force	04-11					
700	KSV700 V-Force	04-11					
700	KVF700 Prairie	04-11					
750	KVF750 Brute Force 4x4	05-09					
750	KVF750 Brute Force 4x4	10-10	ESTX14-BS CTX14(FA) 73,90 € 92,80 €	YTX14-BS YTX14(FA) 103,10 € 115,80 €		YTX14-BS YTX14(FA)	51,60 € 79,70 €
750	KVF750 Brute Force 4x4	11-14					
750	KVF750 Brute Force 4x4	15-20					
KTM							
50	Mini Adventure 50	98-01					
50	Mini Adventure 50	02-07					
50	SX50	03-10					
50	SX50	11-22					
50	SX50 Junior	06-15					
50	SX50 Mini	19-22					
50	SX50 Pro Junior	97-01					
50	SX50 Pro Junior LC	02-06					
50	SX50 Pro Senior	97-01					
50	SX50 Pro Senior LC	02-05					
50	SX50 Senior Adventure	03-07					
60	SX60	98-01					
65	SX65	00-00					
65	SX65	01-02					
65	SX65	03-06					
65	SX65	07-08					
65	SX65	09-22					
80	SX/MX80	91-91					







CATALOGUE ÉLECTRIQUE : Schémas, visuels, spécification et applications

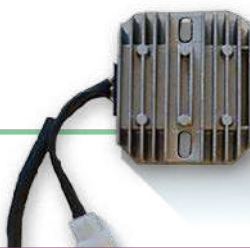

Cyl	Modèle	Année	Sk rich € T.T.C.	NGK STANDARD € T.T.C.	NGK IRIIDIUM € T.T.C.
KAWASAKI					
300	KVF300 4x4	12-19	HJTX20HQ-FP 242,70 €	DR8EA 6,76 €	DR8EIX 26,35 €
360	KVF360 Prairie 2x4	03-09		DPR8EA9 6,65 €	DPR8EIX9 28,06 €
360	KVF360 Prairie 4x4	03-13		DPR8EA9 6,65 €	DPR8EIX9 28,06 €
400	KFX400 (KSF [US])	02-06	HJTX9-FP 93,70 €	CR7E 14,10 €	CR7EIX 27,35 €
400	KLF400 Bayou	93-99	HJTX20HQ-FP 242,70 €	DPR8EA9 6,65 €	DPR8EIX9 28,06 €
400	KVF400 Prairie	97-98		DPR8EA9 6,65 €	DPR8EIX9 28,06 €
400	KVF400 Prairie 2x4	99-02		DPR8EA9 6,65 €	DPR8EIX9 28,06 €
400	KVF400 Prairie 4x4	99-02		DPR8EA9 6,65 €	DPR8EIX9 28,06 €
450	KFX450 R	07-14	HJZ75-FP 99,20 €	CPR8EB9 14,00 €	
450	KLX450 R	05-15	HJZ75-FP 99,20 € HJZ75-FPZ 164,30 €	CPR8EB9 14,00 €	
450	KX450 F	06-18		CPR8EB9 14,00 €	
450	KX450 F - KX	19-22	HJZ55-FP 77,10 €	CPR8EB9 14,00 €	
450	KX450 F Efi	09-16		CPR8EB9 14,00 €	
450	KX450 X Enduro (KL)	22-22	HJZ55-FP 77,10 €	CPR8EB9 14,00 €	
500	KX500	84-04		BR8EG 14,05 €	
650	KFX650 V-Force	01-02	HJTX14H-FP 109,90 €	CR7E 14,10 €	CR7EIX 27,35 €
650	KLX650 C	93-95	HJTX9-FP 93,70 €	DPR8EA9 6,65 €	DPR8EIX9 28,06 €
650	KLX650 R	93-01	HJTX9-FP 93,70 €	DPR8EA9 6,65 €	DPR8EIX9 28,06 €
650	KVF650 Brute Force 4x4i	05-14		CR7E 14,10 €	CR7EIX 27,35 €
650	KVF650 Prairie	01-03		CR7E 14,10 €	CR7EIX 27,35 €
700	KFX700 V-Force	04-11		CR7E 14,10 €	CR7EIX 27,35 €
700	KSV700 V-Force	04-11		CR7E 14,10 €	CR7EIX 27,35 €
700	KVF700 Prairie	04-11		CR7E 14,10 €	CR7EIX 27,35 €
750	KVF750 Brute Force 4x4	05-09		CR7E 14,10 €	CR7EIX 27,35 €
750	KVF750 Brute Force 4x4	10-10	HJTX14H-FP 109,90 €	CR7E 14,10 €	CR7EIX 27,35 €
750	KVF750 Brute Force 4x4	11-14		CR7E 14,10 €	CR7EIX 27,35 €
750	KVF750 Brute Force 4x4	15-20		CPR7EA9 13,60 €	
KTM					
50	Mini Adventure 50	98-01		B8HS 5,20 €	BR8HIX 27,55 €
50	Mini Adventure 50	02-07		BR8HS 6,40 €	BR8HIX 27,55 €
50	SX50	03-10		B8HS 5,20 €	BR8HIX 27,55 €
50	SX50	11-22		LR8B 16,10 €	
50	SX50 Junior	06-15		B8HS 5,20 €	BR8HIX 27,55 €
50	SX50 Mini	19-22		LR8B 16,10 €	
50	SX50 Pro Junior	97-01		B8HS 5,20 €	BR8HIX 27,55 €
50	SX50 Pro Junior LC	02-06		BR8ECM 14,70 €	BR8ECMIX 26,86 €
50	SX50 Pro Senior	97-01		B8HS 5,20 €	BR8HIX 27,55 €
50	SX50 Pro Senior LC	02-05		B8HS 5,20 €	BR8HIX 27,55 €
50	SX50 Senior Adventure	03-07		BR8HS 6,40 €	BR8HIX 27,55 €
60	SX60	98-01		B10SEGV 18,98 €	
65	SX65	00-00		B10SEGV 18,98 €	
65	SX65	01-02		BR10EG 15,10 €	
65	SX65	03-06		B10SEGV 18,98 €	
65	SX65	07-08		BR8ECM 14,70 €	BR8ECMIX 26,86 €
65	SX65	09-22		LR8B 16,10 €	
80	SX/MX80	91-91		B10EGV 18,98 €	

En ligne, moraco.fr/moraco/documents.



Cyl	Modèle	Année	 € T.T.C.	 € T.T.C.	 € T.T.C.	 € T.T.C.
KTM						
85	SX85	03-07				
85	SX85	08-22				
125	EGS125	86-93				
125	EGS125	94-97				
125	EGS125	98-99				
125	EXC125 Enduro	95-00				
125	EXC125 Enduro	01-18				
125	EXE125 Enduro	00-01				
125	LC 2, 125	98-98				
125	MX125	85-86				
125	MX125	87-87				
125	MX125	88-93				
125	MX125	94-94				
125	SX125	93-93				
125	SX125	94-94				
125	SX125	95-98				
125	SX125	99-00				
125	SX125	01-06				
125	SX125	07-22				
125	XC125 W Enduro	19-19				
150	EXC150 TPI Enduro	20-22				
150	SX144	07-08				
150	SX150	09-22				
200	EGS200	98-99				
200	EXC200 Enduro	98-99	ESTX4L-BS 28,90 € CTX4L(FA) 30,90 €	YTX4L-BS 36,30 € YTX4L(FA) 39,40 €	YTX4L-BS 17,80 € YTX4L(FA) 25,60 €	
200	EXC200 Enduro	00-01	ESTX4L-BS 28,90 € CTX4L(FA) 30,90 €	YTX4L-BS 36,30 € YTX4L(FA) 39,40 €	YTX4L-BS 17,80 € YTX4L(FA) 25,60 €	
200	EXC200 Enduro	02-15	ESTX4L-BS 28,90 € CTX4L(FA) 30,90 €	YTX4L-BS 36,30 € YTX4L(FA) 39,40 €	YTX4L-BS 17,80 € YTX4L(FA) 25,60 €	
200	EXC200 Enduro	16-16				
200	SX200	00-06				
250	EGS250	92-93				
250	EGS250	94-97				
250	EGS250	98-99				
250	EXC250 Enduro	95-96				
250	EXC250 Enduro	97-02				
250	EXC250 Enduro	03-17				
250	EXC250 Racing	02-15	ESTX5L-BS 35,95 € CTX5L(FA) 40,20 €	YTX5L-BS 64,80 € YTX5L(FA) 70,90 €	YTX5L-BS 24,10 € YTX5L(FA) 34,90 €	
250	EXC250 TPI Enduro	18-19		YTZ5S 77,40 €		
250	EXC250 TPI Enduro	20-22		YTZ5S 77,40 €		
250	EXC250-F Enduro	07-13				
250	EXC250-F Enduro	14-16				
250	EXC250-F Enduro	17-19		YTZ5S 77,40 €		
250	EXC250-F Enduro	20-22				
250	EXE250 Enduro	04-14				
250	Freeride	13-17	ESTX4L-BS 28,90 € CTX4L(FA) 30,90 €	YTX4L-BS 36,30 € YTX4L(FA) 39,40 €	YTX4L-BS 17,80 € YTX4L(FA) 25,60 €	
250	Freeride F	18-20	ESTX4L-BS 28,90 € CTX4L(FA) 30,90 €	YTX4L-BS 36,30 € YTX4L(FA) 39,40 €	YTX4L-BS 17,80 € YTX4L(FA) 25,60 €	
250	MX250	90-93				







CATALOGUE ÉLECTRIQUE : Schémas, visuels, spécification et applications

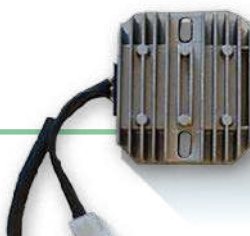

Cyl	Modèle	Année	SKORICH	€ T.T.C.	STANDARD	€ T.T.C.	IRIDIUM	€ T.T.C.
KTM								
85	SX85	03-07			BR10ECMIX	27,40 €	BR10ECMIX	27,40 €
85	SX85	08-22			BR9ECMIX	26,86 €	BR9ECMIX	26,86 €
125	EGS125	86-93			B10EGV	18,98 €		
125	EGS125	94-97			B10EG	11,70 €		
125	EGS125	98-99			R6918B8	86,60 €		
125	EXC125 Enduro	95-00			R6918B8	86,60 €		
125	EXC125 Enduro	01-18			BR9ECMIX	26,86 €	BR9ECMIX	26,86 €
125	EXE125 Enduro	00-01			BR8HS	6,40 €	BR8HIX	27,55 €
125	LC 2, 125	98-98			BR10EG	15,10 €		
125	MX125	85-86			B10EGV	18,98 €		
125	MX125	87-87			R6918B8	86,60 €		
125	MX125	88-93			B10EGV	18,98 €		
125	MX125	94-94			BR10EG	15,10 €		
125	SX125	93-93			B10EGV	18,98 €		
125	SX125	94-94			R6918B8	86,60 €		
125	SX125	95-98			BR10EG	15,10 €		
125	SX125	99-00			R6918B8	86,60 €		
125	SX125	01-06			BR9EIX	26,35 €	BR9EIX	26,35 €
125	SX125	07-22			BR9ECMIX	26,86 €	BR9ECMIX	26,86 €
125	XC125 W Enduro	19-19			BR9ECMIX	26,86 €	BR9ECMIX	26,86 €
150	EXC150 TPI Enduro	20-22			GR8D112	-		
150	SX144	07-08			BR9ECMIX	26,86 €	BR9ECMIX	26,86 €
150	SX150	09-22			BR9ECMIX	26,86 €	BR9ECMIX	26,86 €
200	EGS200	98-99			BR8EG	14,05 €		
200	EXC200 Enduro	98-99	HJTX5L-FP HJTZ5S-FP	55,10 € 77,10 €	BR8EG	14,05 €		
200	EXC200 Enduro	00-01	HJTX5L-FP HJTZ5S-FP	55,10 € 77,10 €	BR9EG	14,65 €		
200	EXC200 Enduro	02-15	HJTX5L-FP HJTZ5S-FP	55,10 € 77,10 €	BR8EG	14,05 €		
200	EXC200 Enduro	16-16			BR8EG	14,05 €		
200	SX200	00-06			BR9EIX	26,35 €		
250	EGS250	92-93			B9EGV	18,98 €		
250	EGS250	94-97			BR8EG	14,05 €		
250	EGS250	98-99			BR8ECM	14,70 €	BR8ECMIX	26,86 €
250	EXC250 Enduro	95-96			BR9EG	14,65 €		
250	EXC250 Enduro	97-02			BR8ECM	14,70 €	BR8ECMIX	26,86 €
250	EXC250 Enduro	03-17			BR7ES	7,06 €	BR7EIX	26,86 €
250	EXC250 Racing	02-15	HJTX5L-FP HJTZ5S-FP	55,10 € 77,10 €	BR7ES	7,06 €	BR7EIX	26,86 €
250	EXC250 TPI Enduro	18-19	HJTZ5S-FP HJTZ7S-FP	77,10 € 99,20 €	ZGR7G113G	-		
250	EXC250 TPI Enduro	20-22	HJTZ5S-FP HJTZ7S-FP	77,10 € 99,20 €	BR7ES	7,06 €		
250	EXC250-F Enduro	07-13			CR9EKB	20,50 €	CR9EIX	26,35 €
250	EXC250-F Enduro	14-16					LMAR9A110	35,35 €
250	EXC250-F Enduro	17-19	HJTZ5S-FP HJTZ7S-FP	77,10 € 99,20 €			LMAR9A110	35,35 €
250	EXC250-F Enduro	20-22					LMAR9A110	35,35 €
250	EXE250 Enduro	04-14			R6918B8	86,60 €		
250	Freeride	13-17	HJTX5L-FP HJTZ5S-FP	55,10 € 77,10 €	BR7ES	7,06 €	BR7EIX	26,86 €
250	Freeride F	18-20	HJTX5L-FP HJTZ5S-FP	55,10 € 77,10 €			LMAR9A110	35,35 €
250	MX250	90-93			B9EGV	18,98 €		

En ligne, moraco.fr/moraco/documents.



Cyl	Modèle	Année		€ T.T.C.		€ T.T.C.		€ T.T.C.		€ T.T.C.
KTM										
250	MX250	94-94								
250	SX250	95-03								
250	SX250 2T	04-22								
250	SX250-F	05-12								
250	SX250-F	13-15								
250	SX250-F	16-17								
250	SX250-F	18-22			YTZ5S	77,40 €				
300	EGS300	92-94								
300	EGS300	95-97								
300	EGS300	98-99								
300	EXC300 Enduro	94-98	ESTX4L-BS CTX4L(FA)	28,90 € 30,90 €	YTX4L-BS YTX4L(FA)	36,30 € 39,40 €	YTX4L-BS YTX4L(FA)	17,80 € 25,60 €		
300	EXC300 Enduro	99-15	ESTX4L-BS CTX4L(FA)	28,90 € 30,90 €	YTX4L-BS YTX4L(FA)	36,30 € 39,40 €	YTX4L-BS YTX4L(FA)	17,80 € 25,60 €		
300	EXC300 Enduro	16-17								
300	EXC300 TPI Enduro	18-19			YTZ5S	77,40 €				
300	EXC300 TPI Enduro	20-22			YTZ5S	77,40 €				
300	SX300	93-95								
350	EXC350-F	12-17								
350	EXC350-F	18-22			YTZ5S	77,40 €				
350	LC4 350	14-14								
350	MX350	87-88								
350	SX350-F	11-16	ESTX4L-BS CTX4L(FA)	28,90 € 30,90 €	YTX4L-BS YTX4L(FA)	36,30 € 39,40 €	YTX4L-BS YTX4L(FA)	17,80 € 25,60 €		
350	SX350-F	17-22			YTZ5S	77,40 €				
360	EGS360	96-97								
360	EXC360	96-97								
360	SX360	96-98								
380	EGS380	98-99								
380	EXC380	98-02								
380	SX380	98-02								
380	XC380	98-99								
400	EGS400 LC4	93-97								
400	EGS400 LC4	98-98								
400	EGS400 LC4 LSE	97-98	ESTX9-BS CTX9(FA)	53,90 € 59,30 €	YTX9-BS YTX9(FA)	64,10 € 72,40 €	YTX9-BS YTX9(FA)	34,80 € 51,20 €		
400	EGS400 LC4-E	99-99	ESTX9-BS CTX9(FA)	53,90 € 59,30 €	YTX9-BS YTX9(FA)	64,10 € 72,40 €	YTX9-BS YTX9(FA)	34,80 € 51,20 €		
400	EGS400 LC4-E 4T	01-01	ESTX9-BS CTX9(FA)	53,90 € 59,30 €	YTX9-BS YTX9(FA)	64,10 € 72,40 €	YTX9-BS YTX9(FA)	34,80 € 51,20 €		
400	EXC400	00-01								
400	EXC400	02-14								
400	SC400	99-00								
400	SX400 Enduro	00-02								
400	SX400 Racing (> 04/2002)	00-02								
400	SX400 Racing (05/2002 >)	02-02								
400	SXC400 Tiainen Replica	99-00								
450	EXC450-F	03-06								
450	EXC450-F	07-08								
450	EXC450-F	09-16								
450	EXC450-F	17-19			YTZ5S	77,40 €				
450	EXC450-F	20-22			YTZ5S	77,40 €				







CATALOGUE ÉLECTRIQUE : Schémas, visuels, spécification et applications

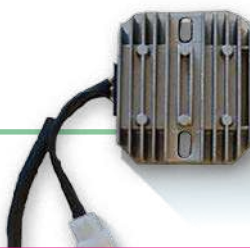

Cyl	Modèle	Année	Skriich	€ T.T.C.	NGK STANDARD	€ T.T.C.	NGK IRIIDIUM	€ T.T.C.
KTM								
250	MX250	94-94			BR8ECM	14,70 €	BR8ECMIX	26,86 €
250	SX250	95-03			BR8ECM	14,70 €	BR8ECMIX	26,86 €
250	SX250 2T	04-22			BR8ECM	14,70 €	BR8ECMIX	26,86 €
250	SX250-F	05-12			CR9EKB	20,50 €	CR9EIX	26,35 €
250	SX250-F	13-15					LMAR9A18	42,16 €
250	SX250-F	16-17	LFP01	99,20 €			LMAR9A18	42,16 €
250	SX250-F	18-22	HJTZ5S-FP	77,10 €			LMAR9A18	42,16 €
300	EGS300	92-94			B9EGV	18,98 €		
300	EGS300	95-97			BR8EG	14,05 €		
300	EGS300	98-99			BR8ECM	14,70 €	BR8ECMIX	26,86 €
300	EXC300 Enduro	94-98	HJTX5L-FP HJTZ5S-FP	55,10 € 77,10 €	BR8ECM	14,70 €	BR8ECMIX	26,86 €
300	EXC300 Enduro	99-15	HJTX5L-FP HJTZ5S-FP	55,10 € 77,10 €	BR7ES	7,06 €	BR7EIX	26,86 €
300	EXC300 Enduro	16-17			BR7ES	7,06 €	BR7EIX	26,86 €
300	EXC300 TPI Enduro	18-19	HJTZ5S-FP HJTZ7S-FP	77,10 € 99,20 €	ZGR7G113G	-		
300	EXC300 TPI Enduro	20-22	HJTZ5S-FP HJTZ7S-FP	77,10 € 99,20 €	BR7ES	7,06 €		
300	SX300	93-95			B9EGV	18,98 €		
350	EXC350-F	12-17					LMAR9A18	42,16 €
350	EXC350-F	18-22	HJTZ5S-FP	77,10 €			LMAR9A18	42,16 €
350	LC4 350	14-14			D8EA	5,86 €	DR8EIX	26,35 €
350	MX350	87-88					BR9EIX	26,35 €
350	SX350-F	11-16	HJTX5L-FP HJTZ5S-FP	55,10 € 77,10 €			LMAR9A18	42,16 €
350	SX350-F	17-22	HJTZ5S-FP	77,10 €			LMAR9A18	42,16 €
360	EGS360	96-97			BR8EG	14,05 €		
360	EXC360	96-97			BR8EG	14,05 €		
360	SX360	96-98			BR8EG	14,05 €		
380	EGS380	98-99			BR8ECM	14,70 €	BR8ECMIX	26,86 €
380	EXC380	98-02			BR8ECM	14,70 €	BR8ECMIX	26,86 €
380	SX380	98-02			BR8ECM	14,70 €	BR8ECMIX	26,86 €
380	XC380	98-99			BR8ECM	14,70 €	BR8ECMIX	26,86 €
400	EGS400 LC4	93-97			D8EA	5,86 €	DR8EIX	26,35 €
400	EGS400 LC4	98-98			DR8EA	6,76 €	DR8EIX	26,35 €
400	EGS400 LC4 LSE	97-98	HJTX9-FP	93,70 €	DR8EA	6,76 €	DR8EIX	26,35 €
400	EGS400 LC4-E	99-99	HJTX9-FP	93,70 €	DR8EA	6,76 €	DR8EIX	26,35 €
400	EGS400 LC4-E 4T	01-01	HJTX9-FP	93,70 €	DR8EA	6,76 €	DR8EIX	26,35 €
400	EXC400	00-01			CR8EK	18,60 €	CR8EIX	26,35 €
400	EXC400	02-14			DCPR8E	11,86 €	DCPR8EIX	29,30 €
400	SC400	99-00			D8EA	5,86 €	DR8EIX	26,35 €
400	SX400 Enduro	00-02			D8EA	5,86 €	DR8EIX	26,35 €
400	SX400 Racing (> 04/2002)	00-02			CR8EK	18,60 €	CR8EIX	26,35 €
400	SX400 Racing (05/2002 >)	02-02			DCPR8E	11,86 €	DCPR8EIX	29,30 €
400	SXC400 Tiainen Replica	99-00			DR8EA	6,76 €	DR8EIX	26,35 €
450	EXC450-F	03-06			DCPR8E	11,86 €	DCPR8EIX	29,30 €
450	EXC450-F	07-08			LKAR8A9	32,00 €		
450	EXC450-F	09-16			LKAR8A9	38,70 €		
450	EXC450-F	17-19	HJTZ5S-FP	77,10 €	LMAR9A110	35,35 €	LMAR9A110	35,35 €
450	EXC450-F	20-22	HJTZ5S-FP	77,10 €	LZMAR8B110	-		

En ligne, moraco.fr/moraco/documents.



Cyl	Modèle	Année	 € T.T.C.	 € T.T.C.	 € T.T.C.	 € T.T.C.
KTM						
450	EXC450-R	02-07				
450	EXC450-R	08-09				
450	EXC450-R	10-16				
450	MXC450	03-06				
450	SMR450	04-08				
450	SMR450	09-10	ESTX5L-BS CTX5L(FA) 35,95 € 40,20 €	YTX5L-BS YTX5L(FA) 64,80 € 70,90 €	YTX5L-BS YTX5L(FA) 24,10 € 34,90 €	
450	SMR450	11-14	ESTX4L-BS CTX4L(FA) 28,90 € 30,90 €	YTX4L-BS YTX4L(FA) 36,30 € 39,40 €	YTX4L-BS YTX4L(FA) 17,80 € 25,60 €	
450	SMR450	21-21	ESTX4L-BS CTX4L(FA) 28,90 € 30,90 €	YTX4L-BS YTX4L(FA) 36,30 € 39,40 €	YTX4L-BS YTX4L(FA) 17,80 € 25,60 €	
450	SX450 ATV	08-10	ESTX5L-BS CTX5L(FA) 35,95 € 40,20 €	YTX5L-BS YTX5L(FA) 64,80 € 70,90 €	YTX5L-BS YTX5L(FA) 24,10 € 34,90 €	
450	SX450 ATV	11-13	ESTX4L-BS CTX4L(FA) 28,90 € 30,90 €	YTX4L-BS YTX4L(FA) 36,30 € 39,40 €	YTX4L-BS YTX4L(FA) 17,80 € 25,60 €	
450	SX450 Racing	03-06				
450	SX450 Racing	15-15				
450	SX450-F	03-06				
450	SX450-F	07-08				
450	SX450-F	09-10	ESTX5L-BS CTX5L(FA) 35,95 € 40,20 €	YTX5L-BS YTX5L(FA) 64,80 € 70,90 €	YTX5L-BS YTX5L(FA) 24,10 € 34,90 €	
450	SX450-F	11-11	ESTX4L-BS CTX4L(FA) 28,90 € 30,90 €	YTX4L-BS YTX4L(FA) 36,30 € 39,40 €	YTX4L-BS YTX4L(FA) 17,80 € 25,60 €	
450	SX450-F	12-15	ESTX4L-BS CTX4L(FA) 28,90 € 30,90 €	YTX4L-BS YTX4L(FA) 36,30 € 39,40 €	YTX4L-BS YTX4L(FA) 17,80 € 25,60 €	
450	SX450-F	16-16				
450	SX450-F	17-22		YTZ5S 77,40 €		
450	SXS450-F	07-08				
450	XC450 ATV	08-08				
450	XC450 ATV	09-13	ESTX5L-BS CTX5L(FA) 35,95 € 40,20 €	YTX5L-BS YTX5L(FA) 64,80 € 70,90 €	YTX5L-BS YTX5L(FA) 24,10 € 34,90 €	
450	XC450-F	07-07				
450	XC450-F	08-08				
450	XC450-F	09-13	ESTX5L-BS CTX5L(FA) 35,95 € 40,20 €	YTX5L-BS YTX5L(FA) 64,80 € 70,90 €	YTX5L-BS YTX5L(FA) 24,10 € 34,90 €	
500	EXC500-F	12-16		YTZ5S 77,40 €		
500	EXC500-F	17-19		YTZ5S 77,40 €		
500	EXC500-F	20-22				
500	GS500 2T	82-84				
500	GS500 4T	82-84				
500	GS500 K4 Enduro 4T	82-84				
500	MX500	88-93				
500	SX500	92-95				
505	SX505	09-13				
505	SX505 F Racing	07-11				
505	SX505 F Racing (US)	07-11				
505	XC505 ATV	08-08				
505	XC505 ATV	09-13	ESTX5L-BS CTX5L(FA) 35,95 € 40,20 €	YTX5L-BS YTX5L(FA) 64,80 € 70,90 €	YTX5L-BS YTX5L(FA) 24,10 € 34,90 €	
520	EXC520 Racing	99-99				
520	EXC520 Racing 2T (> 04/2002)	00-02	ESTX5L-BS CTX5L(FA) 35,95 € 40,20 €	YTX5L-BS YTX5L(FA) 64,80 € 70,90 €	YTX5L-BS YTX5L(FA) 24,10 € 34,90 €	
520	EXC520 Racing 2T (05/2002 >)	02-02	ESTX5L-BS CTX5L(FA) 35,95 € 40,20 €	YTX5L-BS YTX5L(FA) 64,80 € 70,90 €	YTX5L-BS YTX5L(FA) 24,10 € 34,90 €	
520	EXC520 Racing 4T (> 04/2002)	01-02	ESTX5L-BS CTX5L(FA) 35,95 € 40,20 €	YTX5L-BS YTX5L(FA) 64,80 € 70,90 €	YTX5L-BS YTX5L(FA) 24,10 € 34,90 €	
520	EXC520 Racing 4T (05/2002 >)	02-02	ESTX5L-BS CTX5L(FA) 35,95 € 40,20 €	YTX5L-BS YTX5L(FA) 64,80 € 70,90 €	YTX5L-BS YTX5L(FA) 24,10 € 34,90 €	







CATALOGUE ÉLECTRIQUE : Schémas, visuels, spécification et applications

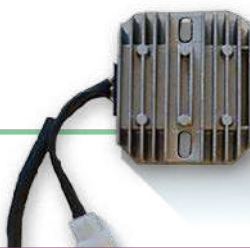

Cyl	Modèle	Année	Sk rich		NGK STANDARD		NGK IRIIDIUM	
				€ T.T.C.		€ T.T.C.		€ T.T.C.
KTM								
450	EXC450-R	02-07			DCPR8E	11,86 €	DCPR8EIX	29,30 €
450	EXC450-R	08-09			LKAR8A9	32,00 €		
450	EXC450-R	10-16					LKAR8A19	38,70 €
450	MXC450	03-06			DCPR8E	11,86 €	DCPR8EIX	29,30 €
450	SMR450	04-08			DCPR8E	11,86 €	DCPR8EIX	29,30 €
450	SMR450	09-10	HJTX5L-FP HJTZ5S-FP	55,10 € 77,10 €	DCPR8E	11,86 €	DCPR8EIX	29,30 €
450	SMR450	11-14	HJTX5L-FP HJTZ5S-FP	55,10 € 77,10 €	DCPR8E	11,86 €	DCPR8EIX	29,30 €
450	SMR450	21-21	HJTX5L-FP HJTZ5S-FP	55,10 € 77,10 €	LMAR9A18	42,16 €		
450	SX450 ATV	08-10	HJTX5L-FP HJTZ5S-FP	55,10 € 77,10 €	CR9EKB	20,50 €		
450	SX450 ATV	11-13	HJTX5L-FP HJTZ5S-FP	55,10 € 77,10 €	CR9EKB	20,50 €		
450	SX450 Racing	03-06			DCPR8E	11,86 €	DCPR8EIX	29,30 €
450	SX450 Racing	15-15			LKAR8A19	38,70 €		
450	SX450-F	03-06			DCPR8E	11,86 €	DCPR8EIX	29,30 €
450	SX450-F	07-08			CR9EKB	20,50 €	CR9EIX	26,35 €
450	SX450-F	09-10	HJTX5L-FP HJTZ5S-FP	55,10 € 77,10 €	CR9EKB	20,50 €	CR9EIX	26,35 €
450	SX450-F	11-11	HJTX5L-FP HJTZ5S-FP	55,10 € 77,10 €	CR9EKB	20,50 €	CR9EIX	26,35 €
450	SX450-F	12-15	HJTX5L-FP HJTZ5S-FP	55,10 € 77,10 €	LKAR8A19	38,70 €		
450	SX450-F	16-16	LFP01	99,20 €	LMAR9A18	42,16 €		
450	SX450-F	17-22	HJTZ5S-FP	77,10 €	LMAR9A18	42,16 €		
450	SXS450-F	07-08			CR9EKB	20,50 €	CR9EIX	26,35 €
450	XC450 ATV	08-08			DCPR8E	11,86 €	DCPR8EIX	29,30 €
450	XC450 ATV	09-13	HJTX5L-FP HJTZ5S-FP	55,10 € 77,10 €	DCPR8E	11,86 €	DCPR8EIX	29,30 €
450	XC450-F	07-07			DCPR8E	11,86 €	DCPR8EIX	29,30 €
450	XC450-F	08-08			DCPR8E	11,86 €	DCPR8EIX	29,30 €
450	XC450-F	09-13	HJTX5L-FP HJTZ5S-FP	55,10 € 77,10 €	DCPR8E	11,86 €	DCPR8EIX	29,30 €
500	EXC500-F	12-16	HJTZ5S-FP	77,10 €	LKAR8A19	38,70 €		
500	EXC500-F	17-19	HJTZ5S-FP	77,10 €	LMAR9A110	35,35 €		
500	EXC500-F	20-22	HJTZ5S-FP	77,10 €	LZMAR8B110	-		
500	GS500 2T	82-84			R6918B8	86,60 €		
500	GS500 4T	82-84			D8EA	5,86 €	DR8EIX	26,35 €
500	GS500 K4 Enduro 4T	82-84			D8EA	5,86 €	DR8EIX	26,35 €
500	MX500	88-93			BR9EIX	26,35 €		
500	SX500	92-95			B10ES	6,10 €		
505	SX505	09-13			CR9EKB	20,50 €	CR9EIX	26,35 €
505	SX505 F Racing	07-11			CR9EKB	20,50 €	CR9EIX	26,35 €
505	SX505 F Racing (US)	07-11			CR9EKB	20,50 €	CR9EIX	26,35 €
505	XC505 ATV	08-08			CR9EKB	20,50 €	CR9EIX	26,35 €
505	XC505 ATV	09-13	HJTX5L-FP HJTZ5S-FP	55,10 € 77,10 €	CR9EKB	20,50 €	CR9EIX	26,35 €
520	EXC520 Racing	99-99			CR8EK	18,60 €	CR8EIX	26,35 €
520	EXC520 Racing 2T (> 04/2002)	00-02	HJTX5L-FP HJTZ5S-FP	55,10 € 77,10 €	CR8EK	18,60 €	CR8EIX	26,35 €
520	EXC520 Racing 2T (05/2002 >)	02-02	HJTX5L-FP HJTZ5S-FP	55,10 € 77,10 €	DCPR8E	11,86 €	DCPR8EIX	29,30 €
520	EXC520 Racing 4T (> 04/2002)	01-02	HJTX5L-FP HJTZ5S-FP	55,10 € 77,10 €	CR8EK	18,60 €	CR8EIX	26,35 €
520	EXC520 Racing 4T (05/2002 >)	02-02	HJTX5L-FP HJTZ5S-FP	55,10 € 77,10 €	DCPR8E	11,86 €	DCPR8EIX	29,30 €

En ligne, moraco.fr/moraco/documents.



Cyl	Modèle	Année		€ T.T.C.		€ T.T.C.		€ T.T.C.		€ T.T.C.
KTM										
520	SX520 Racing	99-99								
520	SX520 Racing 4T (> 04/2002)	01-02	ESTX5L-BS CTX5L(FA)	35,95 € 40,20 €	YTX5L-BS YTX5L(FA)	64,80 € 70,90 €	YTX5L-BS YTX5L(FA)	24,10 € 34,90 €		
520	SX520 Racing 4T (05/2002 >)	02-02	ESTX5L-BS CTX5L(FA)	35,95 € 40,20 €	YTX5L-BS YTX5L(FA)	64,80 € 70,90 €	YTX5L-BS YTX5L(FA)	24,10 € 34,90 €		
525	EXC525 Racing 4T	03-07								
525	MXC525 2T	03-03	ESTX5L-BS CTX5L(FA)	35,95 € 40,20 €	YTX5L-BS YTX5L(FA)	64,80 € 70,90 €	YTX5L-BS YTX5L(FA)	24,10 € 34,90 €		
525	MXC525 4T	03-06	ESTX5L-BS CTX5L(FA)	35,95 € 40,20 €	YTX5L-BS YTX5L(FA)	64,80 € 70,90 €	YTX5L-BS YTX5L(FA)	24,10 € 34,90 €		
525	SX525 Racing 2T	03-03								
525	SX525 Racing 4T	03-08								
525	XC525 ATV	08-13								
530	EXC530	08-11								
530	SX530 Racing	08-08								
540	GS 540	98-00								
540	SXC540 Tiainen Replica	98-00								
560	SMR560	06-07								
600	DUKE 600	93-93	ESTX9-BS CTX9(FA)	53,90 € 59,30 €	YTX9-BS YTX9(FA)	64,10 € 72,40 €	YTX9-BS YTX9(FA)	34,80 € 51,20 €		
600	EGS600 LC4 Enduro	88-93								
600	EXC600 LC4	88-92								
600	LC4 MX	88-99								
620	EXC620 LC4	94-99								
620	SC620	96-97								
620	SC620	98-99	ESTX9-BS CTX9(FA)	53,90 € 59,30 €	YTX9-BS YTX9(FA)	64,10 € 72,40 €	YTX9-BS YTX9(FA)	34,80 € 51,20 €		
620	SC620	00-02								
620	SX620 LC4	94-99	ESTZ10S	95,90 €	YTZ10S	198,70 €	YTZ10S	49,60 €	F49107	109,70 €
620	SXC620 LC4	00-02	ESTZ10S	95,90 €	YTZ10S	198,70 €	YTZ10S	49,60 €	F49107	109,70 €
690	Enduro 690	08-13	ESTZ10S	95,90 €	YTZ10S	198,70 €	YTZ10S	49,60 €	F49107	109,70 €
690	Enduro 690	14-15	ESTZ10S	95,90 €	YTZ10S	198,70 €	YTZ10S	49,60 €	F49107	109,70 €
690	Enduro 690 R	09-14	ESTZ10S	95,90 €	YTZ10S	198,70 €	YTZ10S	49,60 €	F49107	109,70 €
690	Enduro 690 R	15-21	ESTZ10S	95,90 €	YTZ10S	198,70 €	YTZ10S	49,60 €	F49107	109,70 €
KYMCO										
50	FOX 50	00-00	ESB4L-B	25,80 €	YB4L-B YB4L-B pack acide Y4246FA	20,30 € 24,60 € 31,20 €	CB4-LB CB4-LB pack acide CB4L-B(FA)	17,40 € 16,20 € 22,60 €		
50	KXer 50	04-06								
50	Maxxer 50	07-18	ESTX5L-BS CTX5L(FA)	35,95 € 40,20 €	YTX5L-BS YTX5L(FA)	64,80 € 70,90 €	YTX5L-BS YTX5L(FA)	24,10 € 34,90 €		
50	Maxxer 50 S	19-20	ESTX5L-BS CTX5L(FA)	35,95 € 40,20 €	YTX5L-BS YTX5L(FA)	64,80 € 70,90 €	YTX5L-BS YTX5L(FA)	24,10 € 34,90 €		
50	MXer 50	03-06	ESTX5L-BS CTX5L(FA)	35,95 € 40,20 €	YTX5L-BS YTX5L(FA)	64,80 € 70,90 €	YTX5L-BS YTX5L(FA)	24,10 € 34,90 €		
50	MXU50	05-15	ESTX5L-BS CTX5L(FA)	35,95 € 40,20 €	YTX5L-BS YTX5L(FA)	64,80 € 70,90 €	YTX5L-BS YTX5L(FA)	24,10 € 34,90 €		
90	Maxxer 90	15-15								
100	FOX 100	15-15								
150	Mxer 150	03-06	ESTX9-BS CTX9(FA)	53,90 € 59,30 €	YTX9-BS YTX9(FA)	64,10 € 72,40 €	YTX9-BS YTX9(FA)	34,80 € 51,20 €		
150	MXU150	07-19	ESTX9-BS CTX9(FA)	53,90 € 59,30 €	YTX9-BS YTX9(FA)	64,10 € 72,40 €	YTX9-BS YTX9(FA)	34,80 € 51,20 €		
250	KXR250 Sport	04-14	ESTX12-BS CTX12(FA)	68,90 € 81,80 €	YTX12-BS YTX12(FA)	80,10 € 90,00 €	YTX12-BS YTX12(FA)	45,30 € 67,70 €		
250	Maxxer 250	08-17	ESTX12-BS CTX12(FA)	68,90 € 81,80 €	YTX12-BS YTX12(FA)	80,10 € 90,00 €	YTX12-BS YTX12(FA)	45,30 € 67,70 €		







CATALOGUE ÉLECTRIQUE : Schémas, visuels, spécification et applications

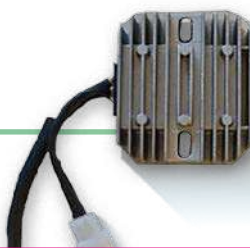

Cyl	Modèle	Année	Sk rich		NGK STANDARD		NGK IRIIDIUM	
				€ T.T.C.		€ T.T.C.		€ T.T.C.
KTM								
520	SX520 Racing	99-99			CR8EK	18,60 €	CR8EIX	26,35 €
520	SX520 Racing 4T (> 04/2002)	01-02	HJTX5L-FP HJTZ5S-FP	55,10 € 77,10 €	CR8EK	18,60 €	CR8EIX	26,35 €
520	SX520 Racing 4T (05/2002 >)	02-02	HJTX5L-FP HJTZ5S-FP	55,10 € 77,10 €	DCPR8E	11,86 €	DCPR8EIX	29,30 €
525	EXC525 Racing 4T	03-07			DCPR8E	11,86 €	DCPR8EIX	29,30 €
525	MXC525 2T	03-03	HJTX5L-FP HJTZ5S-FP	55,10 € 77,10 €	DCPR8E	11,86 €	DCPR8EIX	29,30 €
525	MXC525 4T	03-06	HJTX5L-FP HJTZ5S-FP	55,10 € 77,10 €	DCPR8E	11,86 €	DCPR8EIX	29,30 €
525	SX525 Racing 2T	03-03			DCPR8E	11,86 €	DCPR8EIX	29,30 €
525	SX525 Racing 4T	03-08			DCPR8E	11,86 €	DCPR8EIX	29,30 €
525	XC525 ATV	08-13			DCPR8E	11,86 €	DCPR8EIX	29,30 €
530	EXC530	08-11			LKAR8A9	32,00 €		
530	SX530 Racing	08-08			LKAR8A9	32,00 €		
540	GS 540	98-00			D8EA	5,86 €	DR8EIX	26,35 €
540	SXC540 Tiainen Replica	98-00			D8EA	5,86 €	DR8EIX	26,35 €
560	SMR560	06-07			DCPR8E	11,86 €	DCPR8EIX	29,30 €
600	DUKE 600	93-93	HJTX9-FP	93,70 €	D8EA	5,86 €	DR8EIX	26,35 €
600	EGS600 LC4 Enduro	88-93			D8EA	5,86 €	DR8EIX	26,35 €
600	EXC600 LC4	88-92			D8EA	5,86 €	DR8EIX	26,35 €
600	LC4 MX	88-99			D8EA	5,86 €	DR8EIX	26,35 €
620	EXC620 LC4	94-99			D8EA	5,86 €	DR8EIX	26,35 €
620	SC620	96-97			D8EA	5,86 €	DR8EIX	26,35 €
620	SC620	98-99	HJTX9-FP	93,70 €	D8EA	5,86 €	DR8EIX	26,35 €
620	SC620	00-02			D8EA	5,86 €	DR8EIX	26,35 €
620	SX620 LC4	94-99	HJTZ10S-FP	143,30 €	D8EA	5,86 €	DR8EIX	26,35 €
620	SXC620 LC4	00-02	HJTZ10S-FP	143,30 €	DR8EA	6,76 €	DR8EIX	26,35 €
690	Enduro 690	08-13	HJTZ10S-FP	143,30 €	LKAR8A19	38,70 €		
690	Enduro 690	14-15	HJTZ10S-FP	143,30 €	LKAR8B19 LMAR7A9	40,50 € 32,20 €		
690	Enduro 690 R	09-14	HJTZ10S-FP	143,30 €	LKAR8A19	38,70 €		
690	Enduro 690 R	15-21	HJTZ10S-FP	143,30 €	LKAR8B19 LMAR7A9	40,50 € 32,20 €		
KYMCO								
50	FOX 50	00-00	HJB5L-FP	66,10 €	BR8HSA	7,06 €	BR8HIX	27,55 €
50	KXer 50	04-06			BR8HSA	7,06 €	BR8HIX	27,55 €
50	Maxxer 50	07-18	HJTX5L-FP HJTZ5S-FP	55,10 € 77,10 €	BR8HSA	7,06 €	BR8HIX	27,55 €
50	Maxxer 50 S	19-20	HJTX5L-FP HJTZ5S-FP	55,10 € 77,10 €	BR8HSA	7,06 €	BR8HIX	27,55 €
50	MXer 50	03-06	HJTX5L-FP HJTZ5S-FP	55,10 € 77,10 €	BR8HS	6,40 €	BR8HIX	27,55 €
50	MXU50	05-15	HJTX5L-FP HJTZ5S-FP	55,10 € 77,10 €	BR8HSA	7,06 €	BR8HIX	27,55 €
90	Maxxer 90	15-15			CR7HSA	6,85 €	CR7HIX	26,86 €
100	FOX 100	15-15			BR8HSA	7,06 €	BR8HIX	27,55 €
150	Mxer 150	03-06	HJTX9-FP	93,70 €	DR8EA	6,76 €	DR8EIX	26,35 €
150	MXU150	07-19	HJTX9-FP	93,70 €	DR8EA	6,76 €	DR8EIX	26,35 €
250	KXR250 Sport	04-14	HJTX14H-FP	109,90 €	DPR7EA9	6,65 €	DPR7EIX9	27,30 €
250	Maxxer 250	08-17	HJTX14H-FP	109,90 €	DPR7EA9	6,65 €	DPR7EIX9	27,30 €

En ligne, moraco.fr/moraco/documents.





Cyl	Modèle	Année	 € T.T.C.	 € T.T.C.	 € T.T.C.	 € T.T.C.
KYMCO						
250	MXU250	05-10	ESTX12-BS CTX12(FA) 68,90 € 81,80 €	YTX12-BS YTX12(FA) 80,10 € 90,00 €	YTX12-BS YTX12(FA) 45,30 € 67,70 €	
300	Maxxer 300	06-21	ESTX12-BS CTX12(FA) 68,90 € 81,80 €	YTX12-BS YTX12(FA) 80,10 € 90,00 €	YTX12-BS YTX12(FA) 45,30 € 67,70 €	
300	MXU300	06-21	ESTX12-BS CTX12(FA) 68,90 € 81,80 €	YTX12-BS YTX12(FA) 80,10 € 90,00 €	YTX12-BS YTX12(FA) 45,30 € 67,70 €	
400	MXU400	12-17	ESB14-A2 65,80 €	YB14-A2 69,40 €	CB14-A2 63,60 €	
450	Maxxer 450 I	12-19	ESTX20L-BS 100,90 €	YTX20L-BS YTX20L(FA) 154,10 € 173,60 €	YTX20L-BS YTX20L(FA) 77,90 € 96,90 €	
450	UXV i 450	14-21	ESTX20L-BS 100,90 €	YTX20L-BS YTX20L(FA) 154,10 € 173,60 €	YTX20L-BS YTX20L(FA) 77,90 € 96,90 €	
450	UXV i Sport 450	15-15	ESTX20L-BS 100,90 €	YTX20L-BS YTX20L(FA) 154,10 € 173,60 €	YTX20L-BS YTX20L(FA) 77,90 € 96,90 €	
465	MXU 465	12-15	ESTX20L-BS 100,90 €	YTX20L-BS YTX20L(FA) 154,10 € 173,60 €	YTX20L-BS YTX20L(FA) 77,90 € 96,90 €	
500	MXU500	06-17	ESTX20L-BS 100,90 €	YTX20L-BS YTX20L(FA) 154,10 € 173,60 €	YTX20L-BS YTX20L(FA) 77,90 € 96,90 €	
500	UXV i 500	12-15	ESTX20L-BS 100,90 €	YTX20L-BS YTX20L(FA) 154,10 € 173,60 €	YTX20L-BS YTX20L(FA) 77,90 € 96,90 €	
550	MXU550 I	14-21	ESTX20L-BS 100,90 €	YTX20L-BS YTX20L(FA) 154,10 € 173,60 €	YTX20L-BS YTX20L(FA) 77,90 € 96,90 €	
700	MXU700 I	18-21	ESTX20L-BS 100,90 €	YTX20L-BS YTX20L(FA) 154,10 € 173,60 €	YTX20L-BS YTX20L(FA) 77,90 € 96,90 €	
700	UXV i 700	14-21	ESTX20L-BS 100,90 €	YTX20L-BS YTX20L(FA) 154,10 € 173,60 €	YTX20L-BS YTX20L(FA) 77,90 € 96,90 €	
700	UXV i 700 Sport	15-15	ESTX20L-BS 100,90 €	YTX20L-BS YTX20L(FA) 154,10 € 173,60 €	YTX20L-BS YTX20L(FA) 77,90 € 96,90 €	
MONTESA						
125	Cota 304 125	86-99				
250	Cota 4RT 250	05-13				
260	Cota 309 260	89-90				
260	Cota 310 260	90-92				
260	Cota 311 260	92-96				
260	Evasion 260	91-91				
300	Cota 300 RR	16-19				
360	Enduro 360	85-86				
MUZ						
125	SM125	99-01		YT12A-BS		
125	SX125	99-01		YT12A-BS		
125	VRT125	05-06		YT12A-BS		
POLARIS						
50	Outlaw 50	08-09	ESTX5L-BS CTX5L(FA) 35,95 € 40,20 €	YTX5L-BS YTX5L(FA) 64,80 € 70,90 €	YTX5L-BS YTX5L(FA) 24,10 € 34,90 €	
50	Predator 50	04-05	ESTX5L-BS CTX5L(FA) 35,95 € 40,20 €	YTX5L-BS YTX5L(FA) 64,80 € 70,90 €	YTX5L-BS YTX5L(FA) 24,10 € 34,90 €	
50	Scrambler 50	01-03	ESTX4L-BS CTX4L(FA) 28,90 € 30,90 €	YTX4L-BS YTX4L(FA) 36,30 € 39,40 €	YTX4L-BS YTX4L(FA) 17,80 € 25,60 €	
90	Outlaw 90	08-09	ESTX5L-BS CTX5L(FA) 35,95 € 40,20 €	YTX5L-BS YTX5L(FA) 64,80 € 70,90 €	YTX5L-BS YTX5L(FA) 24,10 € 34,90 €	
90	Predator 90	03-05	ESTX5L-BS CTX5L(FA) 35,95 € 40,20 €	YTX5L-BS YTX5L(FA) 64,80 € 70,90 €	YTX5L-BS YTX5L(FA) 24,10 € 34,90 €	
90	Scrambler 90	01-03	ESTX4L-BS CTX4L(FA) 28,90 € 30,90 €	YTX4L-BS YTX4L(FA) 36,30 € 39,40 €	YTX4L-BS YTX4L(FA) 17,80 € 25,60 €	
90	Sportsman 90	01-11	ESTX4L-BS CTX4L(FA) 28,90 € 30,90 €	YTX4L-BS YTX4L(FA) 36,30 € 39,40 €	YTX4L-BS YTX4L(FA) 17,80 € 25,60 €	
200	Phoenix 200	05-14	ESTX12-BS CTX12(FA) 68,90 € 81,80 €	YTX12-BS YTX12(FA) 80,10 € 90,00 €	YTX12-BS YTX12(FA) 45,30 € 67,70 €	
200	Sawtooth	06-07	ESTX12-BS CTX12(FA) 68,90 € 81,80 €	YTX12-BS YTX12(FA) 80,10 € 90,00 €	YTX12-BS YTX12(FA) 45,30 € 67,70 €	
250	2x4 250	90-93		Y48141627 157,40 €	CB14A-A2 63,60 €	
250	4x4 250	90-93		Y48141627 157,40 €	CB14A-A2 63,60 €	
250	Big Boss 4x6 250	89-93		Y48141627 157,40 €	CB14A-A2 63,60 €	
250	Big Boss 6x6 250	89-93		Y48141627 157,40 €	CB14A-A2 63,60 €	







CATALOGUE ÉLECTRIQUE : Schémas, visuels, spécification et applications

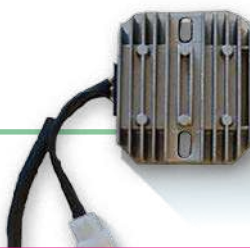

Cyl	Modèle	Année	 Skirich	€ T.T.C.	 STANDARD	€ T.T.C.	 IRIDIUM	€ T.T.C.
KYMCO								
250	MXU250	05-10	HJTX14H-FP	109,90 €	DPR7EA9	6,65 €	DPR7EIX9	27,30 €
300	Maxxer 300	06-21	HJTX14H-FP	109,90 €	DPR7EA9	6,65 €	DPR7EIX9	27,30 €
300	MXU300	06-21	HJTX14H-FP	109,90 €	DPR7EA9	6,65 €	DPR7EIX9	27,30 €
400	MXU400	12-17	HJTX14AHQ-FP	175,30 €	CR8E	13,85 €	CR8EIX	26,35 €
450	Maxxer 450 I	12-19	HJTX20HQ-FP	242,70 €				
450	UXV i 450	14-21	HJTX20HQ-FP	242,70 €	CR6E	13,80 €	CR6EIX	-
450	UXV i Sport 450	15-15	HJTX20HQ-FP	242,70 €	CR6E	13,80 €	CR6EIX	-
465	MXU 465	12-15	HJTX20HQ-FP	242,70 €				
500	MXU500	06-17	HJTX20HQ-FP	242,70 €	CR7E	14,10 €	CR7EIX	27,35 €
500	UXV i 500	12-15	HJTX20HQ-FP	242,70 €	CR7E	14,10 €	CR7EIX	27,35 €
550	MXU550 I	14-21	HJTX20HQ-FP	242,70 €	CR7E	14,10 €	CR7EIX	27,35 €
700	MXU700 I	18-21	HJTX20HQ-FP	242,70 €	CR7E	14,10 €	CR7EIX	27,35 €
700	UXV i 700	14-21	HJTX20HQ-FP	242,70 €	CR7E	14,10 €	CR7EIX	27,35 €
700	UXV i 700 Sport	15-15	HJTX20HQ-FP	242,70 €	CR7E	14,10 €	CR7EIX	27,35 €
MONTESA								
125	Cota 304 125	86-99			B8E5	4,70 €	BR8EIX	26,75 €
250	Cota 4RT 250	05-13			CR6EH9	19,70 €		
260	Cota 309 260	89-90			BPR7ES	5,95 €	BPR7EIX	29,26 €
260	Cota 310 260	90-92			BPR7ES	5,95 €	BPR7EIX	29,26 €
260	Cota 311 260	92-96			BPR5ES	5,86 €	BPR5EIX	29,40 €
260	Evasion 260	91-91			BPR7ES	5,95 €	BPR7EIX	29,26 €
300	Cota 300 RR	16-19			CR6EH9	19,70 €		
360	Enduro 360	85-86			B7ES	5,45 €	BR7EIX	26,86 €
MUZ								
125	SM125	99-01			CR8E	13,85 €	CR8EIX	26,35 €
125	SX125	99-01						
125	VRT125	05-06						
POLARIS								
50	Outlaw 50	08-09	HJTX5L-FP HJTZ5S-FP	55,10 € 77,10 €				
50	Predator 50	04-05	HJTX5L-FP HJTZ5S-FP	55,10 € 77,10 €	BPR7HS	6,95 €	BPR7HIX	28,10 €
50	Scrambler 50	01-03	HJTX5L-FP HJTZ5S-FP	55,10 € 77,10 €	BPR7HS	6,95 €	BPR7HIX	28,10 €
90	Outlaw 90	08-09	HJTX5L-FP HJTZ5S-FP	55,10 € 77,10 €				
90	Predator 90	03-05	HJTX5L-FP HJTZ5S-FP	55,10 € 77,10 €	BPR7HS	6,95 €	BPR7HIX	28,10 €
90	Scrambler 90	01-03	HJTX5L-FP HJTZ5S-FP	55,10 € 77,10 €	BPR7HS	6,95 €	BPR7HIX	28,10 €
90	Sportsman 90	01-11	HJTX5L-FP HJTZ5S-FP	55,10 € 77,10 €	BPR7HS	6,95 €	BPR7HIX	28,10 €
200	Phoenix 200	05-14	HJTX14H-FP	109,90 €	CR6HSA	7,20 €	CR6HIX	26,86 €
200	Sawtooth	06-07	HJTX14H-FP	109,90 €	CR7HSA	6,85 €	CR7HIX	26,86 €
250	2x4 250	90-93	HJTX14AHQ-FP	175,30 €				
250	4x4 250	90-93	HJTX14AHQ-FP	175,30 €				
250	Big Boss 4x6 250	89-93	HJTX14AHQ-FP	175,30 €				
250	Big Boss 6x6 250	89-93	HJTX14AHQ-FP	175,30 €				

En ligne, moraco.fr/moraco/documents.





Cyl	Modèle	Année		€ T.T.C.		€ T.T.C.		€ T.T.C.		€ T.T.C.
POLARIS										
250	Trail Blazer 250	94-05			Y48141627	157,40 €	CB14A-A2	63,60 €		
250	Trail Blazer 250	99-01			Y48141627	157,40 €	CB14A-A2	63,60 €		
250	Trail Boss 250	85-99			Y48141627	157,40 €	CB14A-A2	63,60 €		
250	Trail Boss 2x4 250	91-93			Y48141627	157,40 €	CB14A-A2	63,60 €		
250	Trail Boss 4x4 250	91-92			Y48141627	157,40 €	CB14A-A2	63,60 €		
250	Xplorer 4x4 250	00-02			Y48141627	157,40 €	CB14A-A2	63,60 €		
300	2x4 300	94-95								
300	4x4 300	94-95								
300	Big Boss 6x6 300	94-95								
300	Hawkeye 2x4 300	06-13	ESB14-B2	66,10 €	YB14-B2	75,90 €				
300	Hawkeye 4x4 300	06-13	ESB14-B2	66,10 €	YB14-B2	75,90 €				
300	Sportsman 300	08-13	ESB14-B2	66,10 €	YB14-B2	75,90 €				
300	Xpress 300 L	96-98								
300	Xpress 300 L	99-99			Y48141627	157,40 €	CB14A-A2	63,60 €		
325	Magnum 2x4 325	00-02			Y48141627	157,40 €	CB14A-A2	63,60 €		
325	Magnum 4x4 325	00-02			Y48141627	157,40 €	CB14A-A2	63,60 €		
325	Trail Boss 325	00-02			Y48141627	157,40 €	CB14A-A2	63,60 €		
325	Xpedition 325	00-02			Y48141627	157,40 €	CB14A-A2	63,60 €		
330	ATP330	04-07			Y48141627	157,40 €	CB14A-A2	63,60 €		
330	Hawkeye 2x4 330	06-06			Y48141627	157,40 €	CB14A-A2	63,60 €		
330	Hawkeye 4x4 330	06-06			Y48141627	157,40 €	CB14A-A2	63,60 €		
330	Magnum 2x4 330	03-06			Y48141627	157,40 €	CB14A-A2	63,60 €		
330	Magnum 4x4 330	03-06			Y48141627	157,40 €	CB14A-A2	63,60 €		
330	Trail Blazer 2x4 330	08-13			Y48141627	157,40 €	CB14A-A2	63,60 €		
330	Trail Boss 2x4 330	03-03			Y48141627	157,40 €	CB14A-A2	63,60 €		
330	Trail Boss 2x4 330	04-13			Y48141627	157,40 €	CB14A-A2	63,60 €		
335	Sportsman 4x4 335	99-01			Y48141627	157,40 €	CB14A-A2	63,60 €		
350	Big Boss 6x6 350	93-95			Y48141627	157,40 €	CB14A-A2	63,60 €		
350	Sportsman 4x4 350	93-95			Y48141627	157,40 €	CB14A-A2	63,60 €		
350	Trail Boss 2x4 350 L	90-93			Y48141627	157,40 €	CB14A-A2	63,60 €		
350	Trail Boss 4x4 350 L	90-93			Y48141627	157,40 €	CB14A-A2	63,60 €		
400	Big Boss 6x6 400 L	96-97			Y48141627	157,40 €	CB14A-A2	63,60 €		
400	Scrambler 2x4 400	00-02			Y48141627	157,40 €	CB14A-A2	63,60 €		
400	Scrambler 4x4 400	98-02			Y48141627	157,40 €	CB14A-A2	63,60 €		
400	Scrambler 4x4 400 L	95-97			Y48141627	157,40 €	CB14A-A2	63,60 €		
400	Sport 400 L	94-00			Y48141627	157,40 €	CB14A-A2	63,60 €		
400	Sportsman 400	01-05			Y48141627	157,40 €	CB14A-A2	63,60 €		
400	Sportsman 400 HO	08-13			Y48141627	157,40 €	CB14A-A2	63,60 €		
400	Trail Blazer 2x4 400	03-03			Y48141627	157,40 €	CB14A-A2	63,60 €		
400	Xplorer 4x4 400 L	95-01			Y48141627	157,40 €	CB14A-A2	63,60 €		
400	Xpress 400 L	96-97			Y48141627	157,40 €	CB14A-A2	63,60 €		
425	Magnum 2x4 425	95-98			Y48141627	157,40 €	CB14A-A2	63,60 €		
425	Magnum 4x4 425	95-98			Y48141627	157,40 €	CB14A-A2	63,60 €		
425	Magnum 6x6 425	96-97			Y48141627	157,40 €	CB14A-A2	63,60 €		
425	Ranger 425	01-03			Y48141627	157,40 €	CB14A-A2	63,60 €		
425	Xpedition 4x4 425	00-02			Y48141627	157,40 €	CB14A-A2	63,60 €		
450	Outlaw 450 MXR /S	08-11	ESTX9-BS CTX9(FA)	53,90 € 59,30 €	YTX9-BS YTX9(FA)	64,10 € 72,40 €	YTX9-BS YTX9(FA)	34,80 € 51,20 €		
450	Sportsman 450	06-07								
500	ATP500 HO	04-05								







CATALOGUE ÉLECTRIQUE : Schémas, visuels, spécification et applications

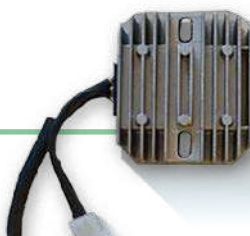

Cyl	Modèle	Année	 Skriich	€ T.T.C.	 STANDARD	€ T.T.C.	 IRIIDIUM	€ T.T.C.
POLARIS								
250	Trail Blazer 250	94-05	HJTX14AHQ-FP	175,30 €	BR8ES	6,35 €	BR8EIX	26,75 €
250	Trail Blazer 250	99-01	HJTX14AHQ-FP	175,30 €	BR8ES	6,35 €	BR8EIX	26,75 €
250	Trail Boss 250	85-99	HJTX14AHQ-FP	175,30 €	BR8ES	6,35 €	BR8EIX	26,75 €
250	Trail Boss 2x4 250	91-93	HJTX14AHQ-FP	175,30 €	BR8ES	6,35 €	BR8EIX	26,75 €
250	Trail Boss 4x4 250	91-92	HJTX14AHQ-FP	175,30 €	BR8ES	6,35 €	BR8EIX	26,75 €
250	Xplorer 4x4 250	00-02	HJTX14AHQ-FP	175,30 €	BR8ES	6,35 €	BR8EIX	26,75 €
300	2x4 300	94-95			BR8ES	6,35 €	BR8EIX	26,75 €
300	4x4 300	94-95			BR8ES	6,35 €	BR8EIX	26,75 €
300	Big Boss 6x6 300	94-95			BR8ES	6,35 €	BR8EIX	26,75 €
300	Hawkeye 2x4 300	06-13	HJTX14AHQ-FP	175,30 €	CR8E	13,85 €	CR8EIX	26,35 €
300	Hawkeye 4x4 300	06-13	HJTX14AHQ-FP	175,30 €	CR8E	13,85 €	CR8EIX	26,35 €
300	Sportsman 300	08-13	HJTX14AHQ-FP	175,30 €				
300	Xpress 300 L	96-98			BKR6E	6,10 €	BKR6EIX	29,90 €
300	Xpress 300 L	99-99	HJTX14AHQ-FP	175,30 €	BKR6E	6,10 €	BKR6EIX	29,90 €
325	Magnum 2x4 325	00-02	HJTX14AHQ-FP	175,30 €	BKR6E	6,10 €	BKR6EIX	29,90 €
325	Magnum 4x4 325	00-02	HJTX14AHQ-FP	175,30 €	BKR6E	6,10 €	BKR6EIX	29,90 €
325	Trail Boss 325	00-02	HJTX14AHQ-FP	175,30 €	BKR6E	6,10 €	BKR6EIX	29,90 €
325	Xpedition 325	00-02	HJTX14AHQ-FP	175,30 €	BKR6E	6,10 €	BKR6EIX	29,90 €
330	ATP330	04-07	HJTX14AHQ-FP	175,30 €	BKR6E	6,10 €	BKR6EIX	29,90 €
330	Hawkeye 2x4 330	06-06	HJTX14AHQ-FP	175,30 €				
330	Hawkeye 4x4 330	06-06	HJTX14AHQ-FP	175,30 €				
330	Magnum 2x4 330	03-06	HJTX14AHQ-FP	175,30 €				
330	Magnum 4x4 330	03-06	HJTX14AHQ-FP	175,30 €				
330	Trail Blazer 2x4 330	08-13	HJTX14AHQ-FP	175,30 €	BKR6E	6,10 €	BKR6EIX	29,90 €
330	Trail Boss 2x4 330	03-03	HJTX14AHQ-FP	175,30 €	BKR6E	6,10 €	BKR6EIX	29,90 €
330	Trail Boss 2x4 330	04-13	HJTX14AHQ-FP	175,30 €	BKR6ES	6,05 €	BKR6EIX	29,90 €
335	Sportsman 4x4 335	99-01	HJTX14AHQ-FP	175,30 €	BKR7E	6,70 €	BKR7EIX	30,35 €
350	Big Boss 6x6 350	93-95	HJTX14AHQ-FP	175,30 €	BR8ES	6,35 €	BR8EIX	26,75 €
350	Sportsman 4x4 350	93-95	HJTX14AHQ-FP	175,30 €	BR8ES	6,35 €	BR8EIX	26,75 €
350	Trail Boss 2x4 350 L	90-93	HJTX14AHQ-FP	175,30 €	BR8ES	6,35 €	BR8EIX	26,75 €
350	Trail Boss 4x4 350 L	90-93	HJTX14AHQ-FP	175,30 €	BR8ES	6,35 €	BR8EIX	26,75 €
400	Big Boss 6x6 400 L	96-97	HJTX14AHQ-FP	175,30 €	BR8ES	6,35 €	BR8EIX	26,75 €
400	Scrambler 2x4 400	00-02	HJTX14AHQ-FP	175,30 €	BR8ES	6,35 €	BR8EIX	26,75 €
400	Scrambler 4x4 400	98-02	HJTX14AHQ-FP	175,30 €	BR8ES	6,35 €	BR8EIX	26,75 €
400	Scrambler 4x4 400 L	95-97	HJTX14AHQ-FP	175,30 €	BR8ES	6,35 €	BR8EIX	26,75 €
400	Sport 400 L	94-00	HJTX14AHQ-FP	175,30 €	BR8ES	6,35 €	BR8EIX	26,75 €
400	Sportsman 400	01-05	HJTX14AHQ-FP	175,30 €	BKR5E	6,16 €	BKR5EIX	26,70 €
400	Sportsman 400 HO	08-13	HJTX14AHQ-FP	175,30 €	BKR5E	6,16 €	BKR5EIX	26,70 €
400	Trail Blazer 2x4 400	03-03	HJTX14AHQ-FP	175,30 €	BR8ES	6,35 €	BR8EIX	26,75 €
400	Xplorer 4x4 400 L	95-01	HJTX14AHQ-FP	175,30 €	BR8ES	6,35 €	BR8EIX	26,75 €
400	Xpress 400 L	96-97	HJTX14AHQ-FP	175,30 €	BR8ES	6,35 €	BR8EIX	26,75 €
425	Magnum 2x4 425	95-98	HJTX14AHQ-FP	175,30 €	BKR6E	6,10 €	BKR6EIX	29,90 €
425	Magnum 4x4 425	95-98	HJTX14AHQ-FP	175,30 €	BKR6E	6,10 €	BKR6EIX	29,90 €
425	Magnum 6x6 425	96-97	HJTX14AHQ-FP	175,30 €	BKR5E	6,16 €	BKR5EIX	26,70 €
425	Ranger 425	01-03	HJTX14AHQ-FP	175,30 €	BKR5E	6,16 €	BKR5EIX	26,70 €
425	Xpedition 4x4 425	00-02	HJTX14AHQ-FP	175,30 €	BKR5E	6,16 €	BKR5EIX	26,70 €
450	Outlaw 450 MXR /S	08-11	HJTX9-FP	93,70 €				
450	Sportsman 450	06-07			CR8E	13,85 €	CR8EIX	26,35 €
500	ATP500 HO	04-05			BKR6ES	6,05 €	BKR6EIX	29,90 €

En ligne, moraco.fr/moraco/documents.



Cyl	Modèle	Année	 € T.T.C.	 € T.T.C.	 € T.T.C.	 € T.T.C.
POLARIS						
500	Big Boss 6x6 500	98-99				
500	Magnum 2x4 500	02-02				
500	Magnum 4x4 500	00-02				
500	Outlaw 500	06-07	ESTX9-BS CTX9(FA) 53,90 € 59,30 €	YTX9-BS YTX9(FA) 64,10 € 72,40 €	YTX9-BS YTX9(FA) 34,80 € 51,20 €	
500	Predator 500	03-04	ESTX9-BS CTX9(FA) 53,90 € 59,30 €	YTX9-BS YTX9(FA) 64,10 € 72,40 €	YTX9-BS YTX9(FA) 34,80 € 51,20 €	
500	Predator 500	05-05				
500	Predator 500	06-07	ESTX9-BS CTX9(FA) 53,90 € 59,30 €	YTX9-BS YTX9(FA) 64,10 € 72,40 €	YTX9-BS YTX9(FA) 34,80 € 51,20 €	
500	Scrambler 2x4 500	00-07				
500	Scrambler 2x4 500 E	08-11				
500	Scrambler 4x4 500	96-07				
500	Scrambler 4x4 500 E	08-12				
500	Sportsman 500 EFI	06-10				
500	Sportsman 500 HO	03-10		Y48141627 157,40 €	CB14A-A2 63,60 €	
500	Sportsman 500 HO	11-14				
500	Sportsman 6x6 500	00-11				
500	Sportsman Touring 500 EFI	08-14				
500	Sportsman X2 500	06-07				
500	Sportsman X2 500 EFI	08-14				
500	Xplorer 4x4 500	97-97				
550	Sportsman XP 550 EFI	09-14				
600	Sportsman 600	03-06				
700	Ranger 6x6 EFI 700	07-13				
700	Ranger 700 Crew	09-13				
700	Ranger 700 HD	09-13				
700	Ranger 700 XP	08-13				
700	Sportsman 700	02-06				
700	Sportsman 700 EFI	05-07				
700	Sportsman 700 MV	05-06				
700	Sportsman X2 700 EFI	08-08				
800	Ranger RZR 800	08-13				
800	Sportsman 800 EFI	05-13				
800	Sportsman Big Boss 6x6 800	09-13				
800	Sportsman HO 800 EFI	08-13				
800	Sportsman Touring 800 EFI	08-13				
800	Sportsman X2 800 EFI	07-13				
850	Sportsman XP 850 EFI	09-13				
RIEJU						
250	MR250	22-22				
300	MR300	21-22				
300	MR300 Ranger	22-22				
450	MRX450	08-11				
SACHS						
50	T-Rex 50	04-05				
125	Dirty Devil 125	07-08				
125	ZX125 Enduro	09-13				
125	ZZ125 Supermoto	09-13				
450	4rock 450	08-08				







CATALOGUE ÉLECTRIQUE : Schémas, visuels, spécification et applications

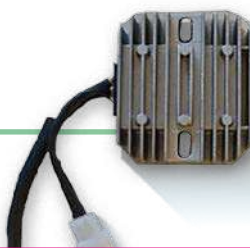

Cyl	Modèle	Année	Skriich	€ T.T.C.	NGK STANDARD	€ T.T.C.	NGK IRIIDIUM	€ T.T.C.
POLARIS								
500	Big Boss 6x6 500	98-99			BKR5E	6,16 €	BKR5EIX	26,70 €
500	Magnum 2x4 500	02-02			BKR5E	6,16 €	BKR5EIX	26,70 €
500	Magnum 4x4 500	00-02			BKR5E	6,16 €	BKR5EIX	26,70 €
500	Outlaw 500	06-07	HJTX9-FP	93,70 €	BKR5E	6,16 €	BKR5EIX	26,70 €
500	Predator 500	03-04	HJTX9-FP	93,70 €	DCPR8E	11,86 €	DCPR8EIX	29,30 €
500	Predator 500	05-05			DCPR8E	11,86 €	DCPR8EIX	29,30 €
500	Predator 500	06-07	HJTX9-FP	93,70 €	DCPR8E	11,86 €	DCPR8EIX	29,30 €
500	Scrambler 2x4 500	00-07			BKR5E	6,16 €	BKR5EIX	26,70 €
500	Scrambler 2x4 500 E	08-11			BKR5E	6,16 €	BKR5EIX	26,70 €
500	Scrambler 4x4 500	96-07			BKR6E	6,10 €	BKR6EIX	29,90 €
500	Scrambler 4x4 500 E	08-12			BKR6E	6,10 €	BKR6EIX	29,90 €
500	Sportsman 500 EFI	06-10			BKR6E	6,10 €	BKR6EIX	29,90 €
500	Sportsman 500 HO	03-10	HJTX14AHQ-FP	175,30 €	BKR6E	6,10 €	BKR6EIX	29,90 €
500	Sportsman 500 HO	11-14			BKR6E	6,10 €	BKR6EIX	29,90 €
500	Sportsman 6x6 500	00-11			BKR6ES	6,05 €	BKR6EIX	29,90 €
500	Sportsman Touring 500 EFI	08-14			BKR6E	6,10 €	BKR6EIX	29,90 €
500	Sportsman X2 500	06-07			BKR6E	6,10 €	BKR6EIX	29,90 €
500	Sportsman X2 500 EFI	08-14			BKR6E	6,10 €	BKR6EIX	29,90 €
500	Xplorer 4x4 500	97-97			BKR5E	6,16 €	BKR5EIX	26,70 €
550	Sportsman XP 550 EFI	09-14			BKR5E	6,16 €	BKR5EIX	26,70 €
600	Sportsman 600	03-06			BKR7E	6,70 €	BKR7EIX	30,35 €
700	Ranger 6x6 EFI 700	07-13			BKR7E	6,70 €	BKR7EIX	30,35 €
700	Ranger 700 Crew	09-13			BKR7E	6,70 €	BKR7EIX	30,35 €
700	Ranger 700 HD	09-13			BKR7E	6,70 €	BKR7EIX	30,35 €
700	Ranger 700 XP	08-13			BKR7E	6,70 €	BKR7EIX	30,35 €
700	Sportsman 700	02-06			BKR7E	6,70 €	BKR7EIX	30,35 €
700	Sportsman 700 EFI	05-07			BKR7E	6,70 €	BKR7EIX	30,35 €
700	Sportsman 700 MV	05-06			BKR7E	6,70 €	BKR7EIX	30,35 €
700	Sportsman X2 700 EFI	08-08			BKR7E	6,70 €	BKR7EIX	30,35 €
800	Ranger RZR 800	08-13			BKR7E	6,70 €	BKR7EIX	30,35 €
800	Sportsman 800 EFI	05-13			BKR7E	6,70 €	BKR7EIX	30,35 €
800	Sportsman Big Boss 6x6 800	09-13			BKR7E	6,70 €	BKR7EIX	30,35 €
800	Sportsman HO 800 EFI	08-13			BKR7E	6,70 €	BKR7EIX	30,35 €
800	Sportsman Touring 800 EFI	08-13			BKR7E	6,70 €	BKR7EIX	30,35 €
800	Sportsman X2 800 EFI	07-13			BKR7E	6,70 €	BKR7EIX	30,35 €
850	Sportsman XP 850 EFI	09-13			LZKAR7A	9,65 €		
RIEJU								
250	MR250	22-22	HJTZ7S-FP HJTZ7S-FPZ	99,20 € 164,30 €	BR8EG	14,05 €		
300	MR300	21-22	HJTZ7S-FP HJTZ7S-FPZ	99,20 € 164,30 €	BR8EG	14,05 €		
300	MR300 Ranger	22-22	HJTZ7S-FP HJTZ7S-FPZ	99,20 € 164,30 €	BR8EG	14,05 €		
450	MRX450	08-11			CR8E	13,85 €	CR8EIX	26,35 €
SACHS								
50	T-Rex 50	04-05			BPR7HS	6,95 €	BPR7HIX	28,10 €
125	Dirty Devil 125	07-08			CR7HSA	6,85 €	CR7HIX	26,86 €
125	ZX125 Enduro	09-13			CR8E	13,85 €	CR8EIX	26,35 €
125	ZZ125 Supermoto	09-13			CR8E	13,85 €	CR8EIX	26,35 €
450	4rock 450	08-08			DCPR7E	10,25 €	DCPR7EIX	27,95 €

En ligne, moraco.fr/moraco/documents.



Cyl	Modèle	Année	 € T.T.C.	 € T.T.C.	 € T.T.C.	 € T.T.C.	
SYM/SANYANG							
200	Track Runner 200	05-09	ESTX9-BS CTX9(FA) 53,90 € 59,30 €	YTX9-BS YTX9(FA) 64,10 € 72,40 €	YTX9-BS YTX9(FA) 34,80 € 51,20 €		
250	QuadLander 250	05-05	ESTX12-BS CTX12(FA) 68,90 € 81,80 €	YTX12-BS YTX12(FA) 80,10 € 90,00 €	YTX12-BS YTX12(FA) 45,30 € 67,70 €		
250	QuadLander 250	06-13	ESTX12-BS CTX12(FA) 68,90 € 81,80 €	YTX12-BS YTX12(FA) 80,10 € 90,00 €	YTX12-BS YTX12(FA) 45,30 € 67,70 €		
300	City Max 300	09-13					
300	Quadlander 300 S	06-13	ESTX12-BS CTX12(FA) 68,90 € 81,80 €	YTX12-BS YTX12(FA) 80,10 € 90,00 €	YTX12-BS YTX12(FA) 45,30 € 67,70 €		
600	Quad Raider 600	08-13	ESTX14-BS CTX14(FA) 73,90 € 92,80 €	YTX14-BS YTX14(FA) 103,10 € 115,80 €	YTX14-BS YTX14(FA) 51,60 € 79,70 €		
SHERCO							
50	Enduro 50	03-13					
50	SE 0.5 50	09-16					
50	Sherco 0.5 50	02-08					
50	Sherco 0.5 50 Kid	05-08					
50	Sherco 0.5 50 Trial	04-08					
50	SM 0.5 50	09-13					
50	SM 0.5 50 Black Panther	09-13					
80	Sherco 0.8 80	03-08					
80	ST 0.8 80	09-13					
125	City Corp 125 Enduro	04-06					
125	City Corp 125 Supermotard	04-06					
125	SE 125-R	18-22	ESTX5L-BS CTX5L(FA) 35,95 € 40,20 €	YTX5L-BS YTX5L(FA) 64,80 € 70,90 €	YTX5L-BS YTX5L(FA) 24,10 € 34,90 €		
125	ST 1.25 125	09-17					
125	ST 125	18-22					
125	TY 125 Classic	19-21	ESTX4L-BS CTX4L(FA) 28,90 € 30,90 €		YTX4L-BS YTX4L(FA) 17,80 € 25,60 €		
125	X-Ride 125	11-11					
125	X-Ride 125	12-19					
200	Sherco 2.0 200	03-06					
250	SE 2.5i-F 250	09-13					
250	SE-R 250	14-22	ESTX5L-BS CTX5L(FA) 35,95 € 40,20 €	YTX5L-BS YTX5L(FA) 64,80 € 70,90 €	YTX5L-BS YTX5L(FA) 24,10 € 34,90 €		
250	SE-R 250 Factory	14-22	ESTX5L-BS CTX5L(FA) 35,95 € 40,20 €	YTX5L-BS YTX5L(FA) 64,80 € 70,90 €	YTX5L-BS YTX5L(FA) 24,10 € 34,90 €		
250	SEF-R 2,5 250 4T	14-22	ESTX5L-BS CTX5L(FA) 35,95 € 40,20 €	YTX5L-BS YTX5L(FA) 64,80 € 70,90 €	YTX5L-BS YTX5L(FA) 24,10 € 34,90 €		
250	SEF-R 2,5 250 4T Factory	14-18	ESTX5L-BS CTX5L(FA) 35,95 € 40,20 €	YTX5L-BS YTX5L(FA) 64,80 € 70,90 €	YTX5L-BS YTX5L(FA) 24,10 € 34,90 €		
250	SEF-R 2,5 250 4T Factory	19-22					
250	Sherco 2.5 250	98-14					
250	ST 2.5 250	09-17					
250	ST 250	18-22					
290	Sherco 2.9 290	01-15					
290	ST 2.9 290	09-13					
290	X-Ride 290	11-19					
300	SE-R 3,0	13-16	ESTX5L-BS CTX5L(FA) 35,95 € 40,20 €	YTX5L-BS YTX5L(FA) 64,80 € 70,90 €	YTX5L-BS YTX5L(FA) 24,10 € 34,90 €		
300	SE-R 3,0 i	10-12					
300	SE-R 300	15-22	ESTX5L-BS CTX5L(FA) 35,95 € 40,20 €	YTX5L-BS YTX5L(FA) 64,80 € 70,90 €	YTX5L-BS YTX5L(FA) 24,10 € 34,90 €		
300	SE-R 300 Factory	13-18	ESTX5L-BS CTX5L(FA) 35,95 € 40,20 €	YTX5L-BS YTX5L(FA) 64,80 € 70,90 €	YTX5L-BS YTX5L(FA) 24,10 € 34,90 €		
300	SE-R 300 Factory	19-22					
300	SEF-R 300 4T	14-22	ESTX5L-BS CTX5L(FA) 35,95 € 40,20 €	YTX5L-BS YTX5L(FA) 64,80 € 70,90 €	YTX5L-BS YTX5L(FA) 24,10 € 34,90 €		







CATALOGUE ÉLECTRIQUE : Schémas, visuels, spécification et applications

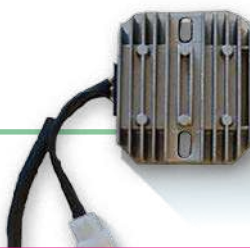

Cyl	Modèle	Année	Sk rich	€ T.T.C.	NGK STANDARD	€ T.T.C.	NGK IRIIDIUM	€ T.T.C.
SYM/SANYANG								
200	Track Runner 200	05-09	HJTX9-FP	93,70 €	CR8E	13,85 €	CR8EIX	26,35 €
250	QuadLander 250	05-05	HJTX14H-FP	109,90 €	CR8E	13,85 €	CR8EIX	26,35 €
250	QuadLander 250	06-13	HJTX14H-FP	109,90 €	CR8HSA	7,36 €	CR8HIX	26,86 €
300	City Max 300	09-13			CR8HSA	7,36 €	CR8HIX	26,86 €
300	Quadlander 300 S	06-13	HJTX14H-FP	109,90 €	CR8E	13,85 €	CR8EIX	26,35 €
600	Quad Raider 600	08-13	HJTX14H-FP	109,90 €	CR8E	13,85 €	CR8EIX	26,35 €
SHERCO								
50	Enduro 50	03-13			BR9ES	6,76 €	BR9EIX	26,35 €
50	SE 0.5 50	09-16			BR9ES	6,76 €	BR9EIX	26,35 €
50	Sherco 0.5 50	02-08			BR9ES	6,76 €	BR9EIX	26,35 €
50	Sherco 0.5 50 Kid	05-08			BR9ES	6,76 €	BR9EIX	26,35 €
50	Sherco 0.5 50 Trial	04-08			BR9ES	6,76 €	BR9EIX	26,35 €
50	SM 0.5 50	09-13			BR9ES	6,76 €	BR9EIX	26,35 €
50	SM 0.5 50 Black Panther	09-13			BR9ES	6,76 €	BR9EIX	26,35 €
80	Sherco 0.8 80	03-08			BP5ES	4,85 €	BPR5EIX	29,40 €
80	ST 0.8 80	09-13			BP5ES	4,85 €	BPR5EIX	29,40 €
125	City Corp 125 Enduro	04-06			CR6HSA	7,20 €	CR6HIX	26,86 €
125	City Corp 125 Supermotard	04-06			CR6HSA	7,20 €	CR6HIX	26,86 €
125	SE 125-R	18-22	HJTX5L-FP HJTZ5S-FP	55,10 € 77,10 €			BR9ECMIX	26,86 €
125	ST 1.25 125	09-17			BP5ES	4,85 €	BPR5EIX	29,40 €
125	ST 125	18-22			BP5ES	4,85 €	BPR5EIX	29,40 €
125	TY 125 Classic	19-21	HJTX5L-FP HJTZ5S-FP	55,10 € 77,10 €	CR6HSA	7,20 €	CR6HIX	26,86 €
125	X-Ride 125	11-11			BPR5ES	5,86 €		
125	X-Ride 125	12-19			BPR5ES	5,86 €	BPR5EIX	29,40 €
200	Sherco 2.0 200	03-06			BP5ES	4,85 €	BPR5EIX	29,40 €
250	SE 2.5i-F 250	09-13			CR8EK	18,60 €		
250	SE-R 250	14-22	HJTX5L-FP HJTZ5S-FP	55,10 € 77,10 €	BR7ES	7,06 €	BR7EIX	26,86 €
250	SE-R 250 Factory	14-22	HJTX5L-FP HJTZ5S-FP	55,10 € 77,10 €	BR7ES	7,06 €	BR7EIX	26,86 €
250	SEF-R 2,5 250 4T	14-22	HJTX5L-FP HJTZ5S-FP	55,10 € 77,10 €	CR8EK	18,60 €		
250	SEF-R 2,5 250 4T Factory	14-18	HJTX5L-FP HJTZ5S-FP	55,10 € 77,10 €	CR8EK	18,60 €		
250	SEF-R 2,5 250 4T Factory	19-22	HJTZ5S-FP	77,10 €	CR8EK	18,60 €		
250	Sherco 2.5 250	98-14			BP5ES	4,85 €	BPR5EIX	29,40 €
250	ST 2.5 250	09-17			BP5ES	4,85 €	BPR5EIX	29,40 €
250	ST 250	18-22			BP5ES	4,85 €	BPR5EIX	29,40 €
290	Sherco 2.9 290	01-15			BP5ES	4,85 €	BPR5EIX	29,40 €
290	ST 2.9 290	09-13			BP5ES	4,85 €	BPR5EIX	29,40 €
290	X-Ride 290	11-19			BP5ES	4,85 €	BPR5EIX	29,40 €
300	SE-R 3,0	13-16	HJTX5L-FP HJTZ5S-FP	55,10 € 77,10 €	BR7ES	7,06 €	BR7EIX	26,86 €
300	SE-R 3,0 i	10-12			BR7ES	7,06 €	BR7EIX	26,86 €
300	SE-R 300	15-22	HJTX5L-FP HJTZ5S-FP	55,10 € 77,10 €	BR7ES	7,06 €	BR7EIX	26,86 €
300	SE-R 300 Factory	13-18	HJTX5L-FP HJTZ5S-FP	55,10 € 77,10 €	BR7ES	7,06 €	BR7EIX	26,86 €
300	SE-R 300 Factory	19-22	HJTZ5S-FP	77,10 €	BR7ES	7,06 €	BR7EIX	26,86 €
300	SEF-R 300 4T	14-22	HJTX5L-FP HJTZ5S-FP	55,10 € 77,10 €	CR8EK	18,60 €		

En ligne, moraco.fr/moraco/documents.



Cyl	Modèle	Année	 € T.T.C.	 € T.T.C.	 € T.T.C.	 € T.T.C.
SHERCO						
300	SEF-R 300 4T Factory	14-18	ESTX5L-BS CTX5L(FA) 35,95 € 40,20 €	YTX5L-BS YTX5L(FA) 64,80 € 70,90 €	YTX5L-BS YTX5L(FA) 24,10 € 34,90 €	
300	SEF-R 300 4T Factory	19-22				
300	ST 3,0 Factory	14-16				
300	ST 3.0 2T	13-17				
300	ST 3.0R 2T	13-14				
300	ST 300	18-22				
320	Sherco 3.2 320	03-08				
450	Enduro 4.5i 450	04-08	EST7B-4 63,70 €	YT7B-BS YT7B(FA) 96,10 € 107,70 €	YT7B-4 50,40 €	
450	SE 4.5i-F 450	09-13				
450	SEF-R 450	17-17				
450	SEF-R 450	18-21	ESTX5L-BS CTX5L(FA) 35,95 € 40,20 €	YTX5L-BS YTX5L(FA) 64,80 € 70,90 €	YTX5L-BS YTX5L(FA) 24,10 € 34,90 €	
450	SEF-R 450 Factory	16-18	ESTX5L-BS CTX5L(FA) 35,95 € 40,20 €	YTX5L-BS YTX5L(FA) 64,80 € 70,90 €	YTX5L-BS YTX5L(FA) 24,10 € 34,90 €	
450	SEF-R 450 Factory	19-21				
450	SM 4.5i-F 450	09-09	ESTX5L-BS CTX5L(FA) 35,95 € 40,20 €	YTX5L-BS YTX5L(FA) 64,80 € 70,90 €	YTX5L-BS YTX5L(FA) 24,10 € 34,90 €	
450	SM 4.5i-F 450	10-13				
450	Supermotard 4.5i 450	05-08	EST7B-4 63,70 €	YT7B-BS YT7B(FA) 96,10 € 107,70 €	YT7B-4 50,40 €	
500	SCF500	19-19				
500	SEF-R 500	20-21				
500	SEF-R 500 Factory	20-21				
510	Enduro 5.1i 510	06-08				
510	SE 5.1i-F 510	09-11				
510	SM 5.1i-F 510	09-13				
510	Supermotard 5.1i 510	07-08				
SUZUKI						
50	LT50	84-99				
50	LT50 A Quadmaster	02-15				
50	LT50 L	98-03				
50	LT50 Z QuadSport	15-20	ESTX5L-BS CTX5L(FA) 35,95 € 40,20 €	YTX5L-BS YTX5L(FA) 64,80 € 70,90 €	YTX5L-BS YTX5L(FA) 24,10 € 34,90 €	
65	RM65	03-06				
70	DR-Z 70 L	12-17				
80	LT80 QuadSport	89-10	ESTX5L-BS CTX5L(FA) 35,95 € 40,20 €	YTX5L-BS YTX5L(FA) 64,80 € 70,90 €	YTX5L-BS YTX5L(FA) 24,10 € 34,90 €	
80	RM80	80-88				
80	RM80	89-89				
80	RM80	90-01				
85	RM85	02-22				
90	LT-Z 90	07-13				
110	DRZ110	01-07				
125	DR-Z 125 /L	03-15				
125	DR-Z 125 L	16-22				
125	LT 125 E,H	84-87				
125	RM125	76-92				
125	RM125	93-95				
125	RM125	96-13				
160	LT160E Quadrunner	89-92		Y3911 -		
160	LT160F QuadSport	91-04		Y3911 -		







CATALOGUE ÉLECTRIQUE : Schémas, visuels, spécification et applications

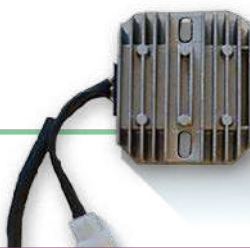

Cyl	Modèle	Année	SKORICH € T.T.C.	STANDARD € T.T.C.	IRIDIUM € T.T.C.
SHERCO					
300	SEF-R 300 4T Factory	14-18	HJTX5L-FP HJTZ5S-FP 55,10 € 77,10 €	CR8EK 18,60 €	
300	SEF-R 300 4T Factory	19-22	HJTZ5S-FP 77,10 €	CR8EK 18,60 €	
300	ST 3,0 Factory	14-16		BP5ES 4,85 €	BPR5EIX 29,40 €
300	ST 3.0 2T	13-17		BP5ES 4,85 €	BPR5EIX 29,40 €
300	ST 3.0R 2T	13-14		BP5ES 4,85 €	BPR5EIX 29,40 €
300	ST 300	18-22		BP5ES 4,85 €	BPR5EIX 29,40 €
320	Sherco 3.2 320	03-08		BCPR6E 6,90 €	
450	Enduro 4.5i 450	04-08	HJT98-FP 115,80 €	CR8EK 18,60 €	
450	SE 4.5i-F 450	09-13		CR8EK 18,60 €	
450	SEF-R 450	17-17		CR8EK 18,60 €	
450	SEF-R 450	18-21	HJTX5L-FP HJTZ5S-FP 55,10 € 77,10 €	LMAR9EJ 33,55 €	
450	SEF-R 450 Factory	16-18	HJTX5L-FP HJTZ5S-FP 55,10 € 77,10 €	LMAR9EJ 33,55 €	
450	SEF-R 450 Factory	19-21	HJTZ5S-FP 77,10 €	LMAR9EJ 33,55 €	
450	SM 4.5i-F 450	09-09	HJTX5L-FP HJTZ5S-FP 55,10 € 77,10 €	LMAR9EJ 33,55 €	
450	SM 4.5i-F 450	10-13		CR8EK 18,60 €	
450	Supermotard 4.5i 450	05-08	HJT98-FP 115,80 €	CR8EK 18,60 €	
500	SCF500	19-19	HJTX5L-FP HJTZ5S-FP 55,10 € 77,10 €	LMAR9EJ 33,55 €	
500	SEF-R 500	20-21	HJTZ5S-FP 77,10 €	LMAR9EJ 33,55 €	
500	SEF-R 500 Factory	20-21	HJTZ5S-FP 77,10 €	LMAR9EJ 33,55 €	
510	Enduro 5.1i 510	06-08		CR8EK 18,60 €	
510	SE 5.1i-F 510	09-11		CR8EK 18,60 €	
510	SM 5.1i-F 510	09-13		CR8EK 18,60 €	
510	Supermotard 5.1i 510	07-08		CR8EK 18,60 €	
SUZUKI					
50	LT50	84-99		BPR4HS 7,15 €	
50	LT50 A Quadmaster	02-15		BPR4HS 7,15 €	
50	LT50 L	98-03		BPR7HS 6,95 €	BPR7HIX 28,10 €
50	LT50 Z Quadspport	15-20	HJTX5L-FP HJTZ5S-FP 55,10 € 77,10 €	CR6HSA 7,20 €	
65	RM65	03-06		BR10EG 15,10 €	BR10EIX 26,86 €
70	DR-Z 70 L	12-17		CR7HSA 6,85 €	CR7HIX 26,86 €
80	LT80 Quadspport	89-10	HJTX5L-FP HJTZ5S-FP 55,10 € 77,10 €	BPR7HS 6,95 €	BPR7HIX 28,10 €
80	RM80	80-88		BR9ES 6,76 €	BR9EIX 26,35 €
80	RM80	89-89		BR9ES 6,76 €	BR9EIX 26,35 €
80	RM80	90-01		BR10ES 8,26 €	BR10EIX 26,86 €
85	RM85	02-22		BR10ES 8,26 €	BR10EIX 26,86 €
90	LT-Z 90	07-13		CR6HSA 7,20 €	CR6HIX 26,86 €
110	DRZ110	01-07		CR6HSA 7,20 €	CR6HIX 26,86 €
125	DR-Z 125 /L	03-15		DR8EA 6,76 €	DR8EIX 26,35 €
125	DR-Z 125 L	16-22		DR8EA 6,76 €	DR8EIX 26,35 €
125	LT 125 E,H	84-87		DR7ES 7,15 €	DR7EIX 28,10 €
125	RM125	76-92		BR9EG 14,65 €	BR9EIX 26,35 €
125	RM125	93-95		R4118S9 16,13 €	
125	RM125	96-13		R6918B8 86,60 €	
160	LT160E Quadrunner	89-92		DPR7EA9 6,65 €	DPR7EIX9 27,30 €
160	LT160F Quadspport	91-04		DPR7EA9 6,65 €	DPR7EIX9 27,30 €

En ligne, moraco.fr/moraco/documents.



Cyl	Modèle	Année	 € T.T.C.	 € T.T.C.	 € T.T.C.	 € T.T.C.
SUZUKI						
230	LT230 EH-EP	86-92	ESTX12-BS CTX12(FA) 68,90 € 81,80 €	YTX12-BS YTX12(FA) 80,10 € 90,00 €	YTX12-BS YTX12(FA) 45,30 € 67,70 €	
230	LT230 EH-EP	93-93				
230	LT230 GEF-GEG	85-86				
230	LT230 SF-SJ	85-88	ESTX12-BS CTX12(FA) 68,90 € 81,80 €	YTX12-BS YTX12(FA) 80,10 € 90,00 €	YTX12-BS YTX12(FA) 45,30 € 67,70 €	
250	DR-Z 250	01-10			YTZ7S 43,90 €	
250	LT-F 250	00-02			CB14A-A2 63,60 €	
250	LT-F 250 Ozark	02-04	ESTX12-BS CTX12(FA) 68,90 € 81,80 €	YTX12-BS YTX12(FA) 80,10 € 90,00 €	YTX12-BS YTX12(FA) 45,30 € 67,70 €	
250	LT-Z 250 QuadSport	04-10	ESTX12-BS CTX12(FA) 68,90 € 81,80 €	YTX12-BS YTX12(FA) 80,10 € 90,00 €	YTX12-BS YTX12(FA) 45,30 € 67,70 €	
250	LT250 EFF-EFG (4T)	85-85				
250	LT250 RF-RH	85-85				
250	LT250 RJ-RR (4temps)	88-88				
250	RM-Z 250	04-05				
250	RM-Z 250	06-12				
250	RM-Z 250	13-22				
250	RM250	82-86				
250	RM250	87-91				
250	RM250	92-95				
250	RM250	96-00				
250	RM250	01-08				
250	RMX250	89-95				
250	RMX250	96-01				
300	LT-F 300 Kingquad	91-11			CB14A-A2 63,60 €	
400	DR-Z 400 /S	00-09	EST7B-4 63,70 €	YT7B-BS YT7B(FA) 96,10 € 107,70 €	YT7B-4 50,40 €	
400	DR-Z 400 E	00-07	EST7B-4 63,70 €	YT7B-BS YT7B(FA) 96,10 € 107,70 €	YT7B-4 50,40 €	
400	LT-A 400 Eiger	02-08	ESTX14-BS CTX14(FA) 73,90 € 92,80 €	YTX14-BS YTX14(FA) 103,10 € 115,80 €	YTX14-BS YTX14(FA) 51,60 € 79,70 €	
400	LT-F 400 Eiger	03-08	ESTX14-BS CTX14(FA) 73,90 € 92,80 €	YTX14-BS YTX14(FA) 103,10 € 115,80 €	YTX14-BS YTX14(FA) 51,60 € 79,70 €	
400	LT-Z 400 QuadSport	03-19	ESTX9-BS CTX9(FA) 53,90 € 59,30 €	YTX9-BS YTX9(FA) 64,10 € 72,40 €	YTX9-BS YTX9(FA) 34,80 € 51,20 €	
400	LT400 A/F King Quad	08-15	ESTX14-BS CTX14(FA) 73,90 € 92,80 €	YTX14-BS YTX14(FA) 103,10 € 115,80 €	YTX14-BS YTX14(FA) 51,60 € 79,70 €	
450	LT-A 450 King Quad	08-08	ESTX14-BS CTX14(FA) 73,90 € 92,80 €	YTX14-BS YTX14(FA) 103,10 € 115,80 €	YTX14-BS YTX14(FA) 51,60 € 79,70 €	
450	LT-R 450 Quadracer	06-14	ESTX7A-BS CTX7A(FA) 47,40 € 53,70 €	YTX7A-BS YTX7A(FA) 70,50 € 75,80 €	YTX7A-BS YTX7A(FA) 35,50 € 46,10 €	
450	RM-Z 450	05-07				
450	RM-Z 450	08-17				
450	RM-Z 450	18-22				
450	RMX450 Z	10-15				
500	LT-A 500 F Quadmaster	00-01		YTX16-BS-1 158,90 €	YTX16-BS-1 78,10 €	
500	LT-A 500 F Vinson	02-03		YTX16-BS-1 158,90 €	YTX16-BS-1 78,10 €	
500	LT-A 500 F Vinson	04-10				
500	LT-A 500 King Quad	11-15				
500	LT-F 500 F Quadrunner	98-03		YTX16-BS-1 158,90 €	YTX16-BS-1 78,10 €	
500	LT-F 500 F Quadrunner	04-10				
500	RM500	83-87				
700	LT-A 700 King Quad	05-10				
750	LT-A750 King Quad	15-15				







CATALOGUE ÉLECTRIQUE : Schémas, visuels, spécification et applications

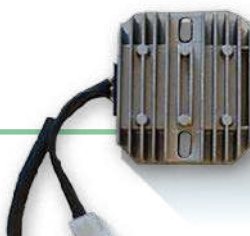

Cyl	Modèle	Année	Sk rich	€ T.T.C.	NGK STANDARD	€ T.T.C.	NGK IRIIDIUM	€ T.T.C.
SUZUKI								
230	LT230 EH-EP	86-92	HJTX14H-FP	109,90 €	D7EA	5,95 €	DR7EIX	28,10 €
230	LT230 EH-EP	93-93			D7EA	5,95 €	DR7EIX	28,10 €
230	LT230 GEF-GEG	85-86			D7EA	5,95 €	DR7EIX	28,10 €
230	LT230 SF-SJ	85-88	HJTX14H-FP	109,90 €	D7EA	5,95 €	DR7EIX	28,10 €
250	DR-Z 250	01-10	HJTX14H-FP	99,20 €				
250	LT-F 250	00-02			DR7EA	6,95 €	DR7EIX	28,10 €
250	LT-F 250 Ozark	02-04	HJTX14H-FP	109,90 €	DR7EA	6,95 €	DR7EIX	28,10 €
250	LT-Z 250 QuadSport	04-10	HJTX14H-FP	109,90 €	DR7ES	7,15 €	DR7EIX	28,10 €
250	LT250 EFF-EFG (4T)	85-85			DR7ES	7,15 €	DR7EIX	28,10 €
250	LT250 RF-RH	85-85			DR7ES	7,15 €	DR7EIX	28,10 €
250	LT250 RJ-RR (4temps)	88-88			DR7ES	7,15 €	DR7EIX	28,10 €
250	RM-Z 250	04-05			CR8EB	13,60 €	CR8EIX	26,35 €
250	RM-Z 250	06-12			CR8EIA10	27,85 €		
250	RM-Z 250	13-22			CR8EIB10	30,16 €		
250	RM250	82-86			B8EGV	18,98 €		
250	RM250	87-91			BR8EIX	26,75 €		
250	RM250	92-95			R4118S8	16,61 €		
250	RM250	96-00			R6918B7	63,28 €		
250	RM250	01-08			BR8EG	14,05 €		
250	RMX250	89-95			B8EGV	18,98 €		
250	RMX250	96-01			BR9EIX	26,35 €	BR9EIX	26,35 €
300	LT-F 300 Kingquad	91-11			D7EA	5,95 €	DR7EIX	28,10 €
400	DR-Z 400 /S	00-09	HJT9B-FP	115,80 €	CR8E	13,85 €	CR8EIX	26,35 €
400	DR-Z 400 E	00-07	HJT9B-FP	115,80 €	CR8E	13,85 €	CR8EIX	26,35 €
400	LT-A 400 Eiger	02-08	HJTX14H-FP	109,90 €	CR7E	14,10 €	CR7EIX	27,35 €
400	LT-F 400 Eiger	03-08	HJTX14H-FP	109,90 €	CR7E	14,10 €	CR7EIX	27,35 €
400	LT-Z 400 QuadSport	03-19	HJTX9-FP	93,70 €	CR8E	13,85 €	CR8EIX	26,35 €
400	LT400 A/F King Quad	08-15	HJTX14H-FP	109,90 €	CR7E	14,10 €	CR7EIX	27,35 €
450	LT-A 450 King Quad	08-08	HJTX14H-FP	109,90 €	CR8EB	13,60 €	CR8EIX	26,35 €
450	LT-R 450 Quadracer	06-14	HJTX7A-FP	81,50 €	CR8EB	13,60 €	CR8EIX	26,35 €
450	RM-Z 450	05-07			CR8EIB10	30,16 €	CR8EIB10	30,16 €
450	RM-Z 450	08-17			DIMR8A10	38,78 €	DIMR8B10	32,93 €
450	RM-Z 450	18-22			DIMR8C10	42,25 €		
450	RMX450 Z	10-15			DIMR8A10	38,78 €	DIMR8B10	32,93 €
500	LT-A 500 F Quadmaster	00-01			CR6E	13,80 €		
500	LT-A 500 F Vinson	02-03			CR7E	14,10 €	CR7EIX	27,35 €
500	LT-A 500 F Vinson	04-10			CR7E	14,10 €	CR7EIX	27,35 €
500	LT-A 500 King Quad	11-15			CR6E	13,80 €		
500	LT-F 500 F Quadrunner	98-03			CR7E	14,10 €	CR7EIX	27,35 €
500	LT-F 500 F Quadrunner	04-10			CR7E	14,10 €	CR7EIX	27,35 €
500	RM500	83-87			B8EGV	18,98 €	BR8EIX	26,75 €
700	LT-A 700 King Quad	05-10			CR6E	13,80 €		
750	LT-A750 King Quad	15-15			CR6E	13,80 €		

En ligne, moraco.fr/moraco/documents.



Cyl	Modèle	Année	 € T.T.C.	 € T.T.C.	 € T.T.C.	 € T.T.C.		
TM								
85	Cross 85 (19"/16")	02-05						
85	Enduro 85 (19"/16")	02-05						
85	MX	16-17						
85	MX	18-19						
85	MX Junior	16-17						
85	MX Junior	18-21						
85	MX Junior >428<	14-15						
125	Cross MX125	98-22						
125	Enduro 125	98-04						
125	Enduro EN125	05-19						
125	Enduro EN125 FI	20-22						
125	SMR125	05-10						
250	Cross 250 /F	01-13						
250	Cross MX 250 2 temps	14-17						
250	Cross MX 250 2 temps	18-22						
250	Cross MX 250 Fi 4 temps	14-18						
250	Cross MX 250 Fi 4 temps	19-22						
250	Enduro 250 /F	01-13						
250	Enduro EN 250 2 temps	14-18						
250	Enduro EN 250 2 temps	19-22						
250	Enduro EN 250 4 temps	14-18						
250	Enduro EN 250 4 temps	19-22						
250	Enduro EN 250 Fi 2 temps	19-22						
300	Cross 300	01-02						
300	Cross 300	03-13						
300	Cross MX 300 2 temps	14-18						
300	Cross MX 300 2 temps	19-22						
300	Enduro 300	01-01						
300	Enduro 300	02-02						
300	Enduro 300	03-09						
300	Enduro 300	10-10	ESTX7A-BS CTX7A(FA)	47,40 € 53,70 €	YTX7A-BS YTX7A(FA)	70,50 € 75,80 €	YTX7A-BS YTX7A(FA)	35,50 € 46,10 €
300	Enduro 300	11-13						
300	Enduro EN 300 2 temps	14-18						
300	Enduro EN 300 2 temps	19-22						
300	Enduro EN 300 4 temps	14-18						
300	Enduro EN 300 4 temps	19-22						
300	Enduro EN 300 Fi 2 temps	19-22						
400	Cross 400	02-10						
400	Enduro 400	01-01						
400	SMF400 F	02-02						
400	SMR400 F	03-03						
450	Cross 450 F	02-17	ESTX7L-BS CTX7L(FA)	49,60 € 52,90 €	YTX7L-BS YTX7L(FA)	70,50 € 75,20 €	YTX7L-BS YTX7L(FA)	33,40 € 47,30 €
450	Cross 450 F	18-19						
450	Cross 450 F	20-22						
450	Enduro 450 F	02-16	ESTX7L-BS CTX7L(FA)	49,60 € 52,90 €	YTX7L-BS YTX7L(FA)	70,50 € 75,20 €	YTX7L-BS YTX7L(FA)	33,40 € 47,30 €
450	Enduro 450 F	17-17						
450	Enduro 450 F	18-19						
450	Enduro 450 F	20-22						







CATALOGUE ÉLECTRIQUE : Schémas, visuels, spécification et applications

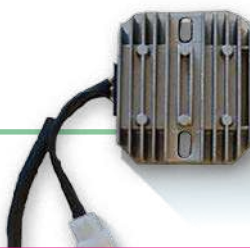

Cyl	Modèle	Année	Sk rich		NGK STANDARD		NGK IRIIDIUM	
				€ T.T.C.		€ T.T.C.		€ T.T.C.
TM								
85	Cross 85 (19"/16")	02-05			BR9EG	14,65 €		
85	Enduro 85 (19"/16")	02-05			BR9EG	14,65 €		
85	MX	16-17			BR9EG	14,65 €		
85	MX	18-19					BR9ECMIX	26,86 €
85	MX Junior	16-17			BR9EG	14,65 €		
85	MX Junior	18-21					BR9ECMIX	26,86 €
85	MX Junior >428<	14-15			BR9EG	14,65 €		
125	Cross MX125	98-22			BR9EG	14,65 €		
125	Enduro 125	98-04			BR9EG	14,65 €		
125	Enduro EN125	05-19			BR9EG	14,65 €		
125	Enduro EN125 FI	20-22			BR9EG	14,65 €		
125	SMR125	05-10			BR9EG	14,65 €		
250	Cross 250 /F	01-13			CR8E	13,85 €	CR8EIX	26,35 €
250	Cross MX 250 2 temps	14-17			BR8EG	14,05 €		
250	Cross MX 250 2 temps	18-22			BKR8EIX	28,20 €		
250	Cross MX 250 Fi 4 temps	14-18			CR8E	13,85 €	CR8EIX	26,35 €
250	Cross MX 250 Fi 4 temps	19-22			R0451B8	69,80 €		
250	Enduro 250 /F	01-13			CR8E	13,85 €	CR8EIX	26,35 €
250	Enduro EN 250 2 temps	14-18			BR8EG	14,05 €		
250	Enduro EN 250 2 temps	19-22			BKR8EIX	28,20 €		
250	Enduro EN 250 4 temps	14-18			CR8E	13,85 €	CR8EIX	26,35 €
250	Enduro EN 250 4 temps	19-22			R0451B8	69,80 €		
250	Enduro EN 250 Fi 2 temps	19-22			BKR8EIX	28,20 €		
300	Cross 300	01-02			BR9EG	14,65 €		
300	Cross 300	03-13			BR8EG	14,05 €		
300	Cross MX 300 2 temps	14-18			BR8EG	14,05 €		
300	Cross MX 300 2 temps	19-22			BKR8EIX	28,20 €		
300	Enduro 300	01-01			BR8EG	14,05 €		
300	Enduro 300	02-02			BR9EG	14,65 €		
300	Enduro 300	03-09			BR8EG	14,05 €		
300	Enduro 300	10-10	HJTX7A-FP	81,50 €	BR9EG	14,65 €		
300	Enduro 300	11-13			BR8EG	14,05 €		
300	Enduro EN 300 2 temps	14-18			BR8EG	14,05 €		
300	Enduro EN 300 2 temps	19-22			BKR8EIX	28,20 €		
300	Enduro EN 300 4 temps	14-18			CR8E	13,85 €	CR8EIX	26,35 €
300	Enduro EN 300 4 temps	19-22			R0451B8	69,80 €		
300	Enduro EN 300 Fi 2 temps	19-22			BKR8EIX	28,20 €		
400	Cross 400	02-10			CR8E	13,85 €	CR8EIX	26,35 €
400	Enduro 400	01-01			CR8E	13,85 €	CR8EIX	26,35 €
400	SMF400 F	02-02			CR8E	13,85 €	CR8EIX	26,35 €
400	SMR400 F	03-03			CR8E	13,85 €	CR8EIX	26,35 €
450	Cross 450 F	02-17	HJTZ7S-FP	99,20 €	CR8E	13,85 €	CR8EIX	26,35 €
450	Cross 450 F	18-19			CR9E	13,90 €	CR9EIX	26,35 €
450	Cross 450 F	20-22			R0451B8	69,80 €		
450	Enduro 450 F	02-16	HJTZ7S-FP	99,20 €	CR8E	13,85 €	CR8EIX	26,35 €
450	Enduro 450 F	17-17			CR8E	13,85 €	CR8EIX	26,35 €
450	Enduro 450 F	18-19			CR9E	13,90 €	CR9EIX	26,35 €
450	Enduro 450 F	20-22			R0451B8	69,80 €		

En ligne, moraco.fr/moraco/documents.



Cyl	Modèle	Année	 € T.T.C.	 € T.T.C.	 € T.T.C.	 € T.T.C.
TM						
450	SMR450 F	04-17	ESTX7L-BS CTX7L(FA) 49,60 € 52,90 €	YTX7L-BS YTX7L(FA) 70,50 € 75,20 €	YTX7L-BS YTX7L(FA) 33,40 € 47,30 €	
450	SMX450 F	03-14	ESTX7L-BS CTX7L(FA) 49,60 € 52,90 €	YTX7L-BS YTX7L(FA) 70,50 € 75,20 €	YTX7L-BS YTX7L(FA) 33,40 € 47,30 €	
530	Cross 530 F	01-11	ESTX7L-BS CTX7L(FA) 49,60 € 52,90 €	YTX7L-BS YTX7L(FA) 70,50 € 75,20 €	YTX7L-BS YTX7L(FA) 33,40 € 47,30 €	
530	Enduro 530 F	01-14	ESTX7L-BS CTX7L(FA) 49,60 € 52,90 €	YTX7L-BS YTX7L(FA) 70,50 € 75,20 €	YTX7L-BS YTX7L(FA) 33,40 € 47,30 €	
530	Enduro 530 F	19-21				
530	SMR530 F	03-17	ESTX7L-BS CTX7L(FA) 49,60 € 52,90 €	YTX7L-BS YTX7L(FA) 70,50 € 75,20 €	YTX7L-BS YTX7L(FA) 33,40 € 47,30 €	
600	SMX600 F	03-09				
600	SMX600 F	10-11		12N5.5-3B 42,30 €		
660	SMX660 F	04-11				
VOR						
400	EN400	02-02				
400	MX400	02-02				
400	SM400	02-02				
450	EN450	02-02				
450	MX450	02-02				
450	SM450	02-02				
530	EN530	02-02				
530	MX530	02-02				
530	SM530	02-02				
YAMAHA						
50	PW50	80-21				
50	TT-R50 E	18-22		YT4B-5 -		
50	TY50 M	77-80		6N4A-4D 24,00 €		
60	YZ60	85-85				
65	YZ 65	18-22				
80	PW80	83-13				
80	YFM80 Badger	95-01				
80	YFM80 Raptor	02-07				
80	YZ80	74-83				
80	YZ80	84-85				
80	YZ80	86-92				
80	YZ80 (17"/14")	93-01				
80	YZ80 (19"/16")	93-01				
85	YZ85 /LW (19"/16")	02-22				
90	TT90 R	00-03				
100	RT100	90-90		6N4-2A-4 19,30 €		
110	TT-R110 E	08-22				
125	TT125 R	00-22	ESTX4L-BS CTX4L(FA) 28,90 € 30,90 €	YTX4L-BS YTX4L(FA) 36,30 € 39,40 €	YTX4L-BS YTX4L(FA) 17,80 € 25,60 €	
125	TY125	80-82		6N4B-2A 27,10 €		
125	WR125	91-03				
125	YFA125 Breeze	89-04		YB12C-A 70,65 €	CB12C-A 56,10 €	
125	YFM125 Grizzly	04-13		YB12C-A 70,65 €	CB12C-A 56,10 €	
125	YZ125	76-92				
125	YZ125	93-07				
125	YZ125	08-22				
200	WR200 R	91-97				
200	YFS200 Blaster	88-06				







CATALOGUE ÉLECTRIQUE : Schémas, visuels, spécification et applications

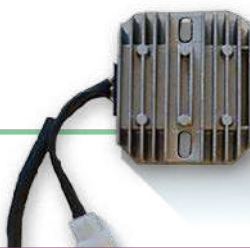

Cyl	Modèle	Année	Sk rich	€ T.T.C.	NGK STANDARD	€ T.T.C.	NGK IRIIDIUM	€ T.T.C.
TM								
450	SMR450 F	04-17	HJTZ7S-FP	99,20 €	CR8E	13,85 €	CR8EIX	26,35 €
450	SMX450 F	03-14	HJTZ7S-FP	99,20 €	CR8E	13,85 €	CR8EIX	26,35 €
530	Cross 530 F	01-11	HJTZ7S-FP	99,20 €	CR8E	13,85 €	CR8EIX	26,35 €
530	Enduro 530 F	01-14	HJTZ7S-FP	99,20 €	CR8E	13,85 €	CR8EIX	26,35 €
530	Enduro 530 F	19-21			CR9E	13,90 €	CR9EIX	26,35 €
530	SMR530 F	03-17	HJTZ7S-FP	99,20 €	CR8E	13,85 €	CR8EIX	26,35 €
600	SMX600 F	03-09			CR8E	13,85 €	CR8EIX	26,35 €
600	SMX600 F	10-11			CR8E	13,85 €	CR8EIX	26,35 €
660	SMX660 F	04-11			CR8E	13,85 €	CR8EIX	26,35 €
VOR								
400	EN400	02-02			CR7EK	20,15 €	CR7EIX	27,35 €
400	MX400	02-02			CR7EK	20,15 €	CR7EIX	27,35 €
400	SM400	02-02			CR7EK	20,15 €	CR7EIX	27,35 €
450	EN450	02-02			CR8EK	18,60 €	CR8EIX	26,35 €
450	MX450	02-02			CR8EK	18,60 €	CR8EIX	26,35 €
450	SM450	02-02			CR8EK	18,60 €	CR8EIX	26,35 €
530	EN530	02-02			CR8EK	18,60 €	CR8EIX	26,35 €
530	MX530	02-02			CR7EK	20,15 €	CR7EIX	27,35 €
530	SM530	02-02			CR7EK	20,15 €	CR7EIX	27,35 €
YAMAHA								
50	PW50	80-21			BPR4HS	7,15 €		
50	TT-R50 E	18-22			CR7HSA	6,85 €	CR7HIX	26,86 €
50	TY50 M	77-80			B6HS	5,20 €	BR6HIX	28,10 €
60	YZ60	85-85			B8ES	4,70 €	BR8EIX	26,75 €
65	YZ 65	18-22			BR9ECM	14,70 €	BR9ECMIX	26,86 €
80	PW80	83-13			BPR6HS	6,25 €	BPR6HIX	27,42 €
80	YFM80 Badger	95-01			C7HSA	5,86 €	CR7HIX	26,86 €
80	YFM80 Raptor	02-07			CR7HSA	6,85 €	CR7HIX	26,86 €
80	YZ80	74-83			B8ES	4,70 €	BR8EIX	26,75 €
80	YZ80	84-85			B9EG	11,86 €		
80	YZ80	86-92			BR9EG	14,65 €		
80	YZ80 (17"/14")	93-01			B10EG	11,70 €		
80	YZ80 (19"/16")	93-01			B10EG	11,70 €		
85	YZ85 /LW (19"/16")	02-22			BR10EG	15,10 €		
90	TT90 R	00-03			CR6HSA	7,20 €	CR6HIX	26,86 €
100	RT100	90-90			B7ES	5,45 €	BR7EIX	26,86 €
110	TT-R110 E	08-22			CR6HSA	7,20 €	CR6HIX	26,86 €
125	TT125 R	00-22	HJTX5L-FP HJTZ5S-FP	55,10 € 77,10 €	CR7HSA	6,85 €	CR7HIX	26,86 €
125	TY125	80-82			B7HS	5,26 €	BR7HIX	26,86 €
125	WR125	91-03			BR9EG	14,65 €		
125	YFA125 Breeze	89-04	HJTX14AHQ-FP	175,30 €	CR7HSA	6,85 €	CR7HIX	26,86 €
125	YFM125 Grizzly	04-13	HJTX14AHQ-FP	175,30 €	CR7HSA	6,85 €	CR7HIX	26,86 €
125	YZ125	76-92			B9EG	11,86 €		
125	YZ125	93-07			BR9EG	14,65 €		
125	YZ125	08-22			BR9EIX	26,35 €		
200	WR200 R	91-97			BR9ES	6,76 €	BR9EIX	26,35 €
200	YFS200 Blaster	88-06	HJTX14AHQ-FP	175,30 €	BR8ES	6,35 €	BR8EIX	26,75 €

En ligne, moraco.fr/moraco/documents.



Cyl	Modèle	Année	 € T.T.C.	 € T.T.C.	 € T.T.C.	 € T.T.C.
YAMAHA						
225	TT225R	01-01	EST7B-4 63,70 €	YT7B-BS YT7B(FA) 96,10 € 107,70 €	YT7B-4 50,40 €	
230	TT230R	05-16	ESTZ7S 54,90 €	YTZ7S 162,90 €	YTZ7S 43,90 €	F4977 69,30 €
250	TT250 R	87-92				
250	TT250 R	93-07	EST7B-4 63,70 €	YT7B-BS YT7B(FA) 96,10 € 107,70 €	YT7B-4 50,40 €	
250	WR250	91-96				
250	WR250	97-02				
250	WR250 F	01-02				
250	WR250 F	03-06	ESTX5L-BS CTX5L(FA) 35,95 € 40,20 €	YTX5L-BS YTX5L(FA) 64,80 € 70,90 €	YTX5L-BS YTX5L(FA) 24,10 € 34,90 €	
250	WR250 F	07-14	ESTZ7S 54,90 €	YTZ7S 162,90 €	YTZ7S 43,90 €	F4977 69,30 €
250	WR250 F	15-19	ESTZ7S 54,90 €	YTZ7S 162,90 €	YTZ7S 43,90 €	F4977 69,30 €
250	WR250 F	20-22	ESTZ7S 54,90 €	YTZ7S 162,90 €	YTZ7S 43,90 €	F4977 69,30 €
250	WR250 Z	91-05				
250	XG250 Tricker	05-06	ESTZ7S 54,90 €	YTZ7S 162,90 €	YTZ7S 43,90 €	F4977 69,30 €
250	YFM250 AN Bruin	05-06			CB14A-A2 63,60 €	
250	YFM250 Bear Tracker	00-05			CB14A-A2 63,60 €	
250	YFM250 R Raptor	08-13	ESTZ7S 54,90 €	YTZ7S 162,90 €	YTZ7S 43,90 €	F4977 69,30 €
250	YFM250 Timberwolf	95-99		YB12C-A 70,65 €	CB12C-A 56,10 €	
250	YZ250	81-84				
250	YZ250	85-95				
250	YZ250	96-22				
250	YZ250 F	01-13				
250	YZ250 F	14-18				
250	YZ250 F	19-22				
250	YZ250 X	16-19				
350	TT350	86-97		6N2-2A-4 17,00 €		
350	YFM350 Bruin	04-05		Y48141627 157,40 €	CB14A-A2 63,60 €	
350	YFM350 Bruin	06-06		YB12C-A 70,65 €	CB12C-A 56,10 €	
350	YFM350 FX Wolverine	95-04		YB12C-A 70,65 €	CB12C-A 56,10 €	
350	YFM350 Grizzly	07-18		Y48141627 157,40 €	CB14A-A2 63,60 €	
350	YFM350 R Raptor	04-16	ESTZ10S 95,90 €	YTZ10S 198,70 €	YTZ10S 49,60 €	F49107 109,70 €
350	YFM350 X Warrior	87-04		YB12C-A 70,65 €	CB12C-A 56,10 €	
350	YFZ350 Banshee	90-05				
400	WR400 F	98-01				
400	YFM400 FA Kodiak	00-05	ESTX20L-BS 100,90 €	YTX20L-BS YTX20L(FA) 154,10 € 173,60 €	YTX20L-BS YTX20L(FA) 77,90 € 96,90 €	
400	YFM400 FP Big Bear	03-05	ESTX20L-BS 100,90 €	YTX20L-BS YTX20L(FA) 154,10 € 173,60 €	YTX20L-BS YTX20L(FA) 77,90 € 96,90 €	
400	YFM400 FW Big Bear Pro	00-03	ESTX20L-BS 100,90 €	YTX20L-BS YTX20L(FA) 154,10 € 173,60 €	YTX20L-BS YTX20L(FA) 77,90 € 96,90 €	
400	YZ400 F	98-99				
426	WR426 F	01-02				
426	YZ426 F	00-02				
450	WR450 F	03-18	ESTZ7S 54,90 €	YTZ7S 162,90 €	YTZ7S 43,90 €	F4977 69,30 €
450	WR450 F	19-22	ESTZ7S 54,90 €	YTZ7S 162,90 €	YTZ7S 43,90 €	F4977 69,30 €
450	YFM450 FA Kodiak	03-06	ESTX20L-BS 100,90 €	YTX20L-BS YTX20L(FA) 154,10 € 173,60 €	YTX20L-BS YTX20L(FA) 77,90 € 96,90 €	
450	YFM450 FG Grizzly	07-12	ESTX20L-BS 100,90 €	YTX20L-BS YTX20L(FA) 154,10 € 173,60 €	YTX20L-BS YTX20L(FA) 77,90 € 96,90 €	







CATALOGUE ÉLECTRIQUE : Schémas, visuels, spécification et applications

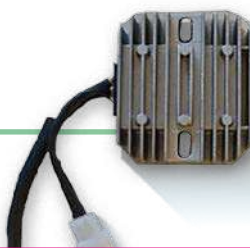

Cyl	Modèle	Année	SKORICH	€ T.T.C.	STANDARD	€ T.T.C.	IRIDIUM	€ T.T.C.
YAMAHA								
225	TT225R	01-01	HJT98-FP	115,80 €	DR8ESL	6,65 €	DR8EIX	26,35 €
230	TT230R	05-16	HJTZ75-FP HJTZ75-FPZ	99,20 € 164,30 €	DR8EA	6,76 €	DR8EIX	26,35 €
250	TT250 R	87-92			D8EA	5,86 €	DR8EIX	26,35 €
250	TT250 R	93-07	HJT98-FP	115,80 €	CR9E	13,90 €	CR9EIX	26,35 €
250	WR250	91-96			B8EG	11,95 €		
250	WR250	97-02			BR8EG	14,05 €		
250	WR250 F	01-02			CR8E	13,85 €	CR8EIX	26,35 €
250	WR250 F	03-06	HJTX5L-FP HJTZ5S-FP	55,10 € 77,10 €	CR8E	13,85 €	CR8EIX	26,35 €
250	WR250 F	07-14	HJTZ75-FP HJTZ75-FPZ	99,20 € 164,30 €	CR8E	13,85 €	CR8EIX	26,35 €
250	WR250 F	15-19	HJTZ75-FP HJTZ75-FPZ	99,20 € 164,30 €	LMAR8G	17,60 €		
250	WR250 F	20-22	HJTZ75-FP HJTZ75-FPZ	99,20 € 164,30 €	LMAR8EJ	-		
250	WR250 Z	91-05			BR8EG	14,05 €		
250	XG250 Tricker	05-06	HJTZ75-FP HJTZ75-FPZ	99,20 € 164,30 €	DR7EA	6,95 €	DR7EIX	28,10 €
250	YFM250 AN Bruin	05-06			DR7EA	6,95 €	DR7EIX	28,10 €
250	YFM250 Bear Tracker	00-05			DR7EA	6,95 €	DR7EIX	28,10 €
250	YFM250 R Raptor	08-13	HJTZ75-FP HJTZ75-FPZ	99,20 € 164,30 €	DR7EA	6,95 €	DR7EIX	28,10 €
250	YFM250 Timberwolf	95-99	HJTX14AHQ-FP	175,30 €	DR7EA	6,95 €	DR7EIX	28,10 €
250	YZ250	81-84			B9EG	11,86 €	BR9EIX	26,35 €
250	YZ250	85-95			B8EG	11,95 €	BR8EIX	26,75 €
250	YZ250	96-22			BR8EG	14,05 €	BR8EIX	26,75 €
250	YZ250 F	01-13			CR8E	13,85 €	CR8EIX	26,35 €
250	YZ250 F	14-18			LMAR8G	17,60 €		
250	YZ250 F	19-22			LMAR9EJ	33,55 €		
250	YZ250 X	16-19			BR8EG	14,05 €	BR8EIX	26,75 €
350	TT350	86-97			D8EA	5,86 €	DR8EIX	26,35 €
350	YFM350 Bruin	04-05	HJTX14AHQ-FP	175,30 €	DR8ESL	6,65 €	DR8EIX	26,35 €
350	YFM350 Bruin	06-06	HJTX14AHQ-FP	175,30 €	DR8EA	6,76 €	DR8EIX	26,35 €
350	YFM350 FX Wolverine	95-04	HJTX14AHQ-FP	175,30 €	DR8EA	6,76 €	DR8EIX	26,35 €
350	YFM350 Grizzly	07-18	HJTX14AHQ-FP	175,30 €	DR8EA	6,76 €	DR8EIX	26,35 €
350	YFM350 R Raptor	04-16	HJTZ10S-FP	143,30 €	DR8EA	6,76 €	DR8EIX	26,35 €
350	YFM350 X Warrior	87-04	HJTX14AHQ-FP	175,30 €	DR8EA	6,76 €	DR8EIX	26,35 €
350	YFZ350 Banshee	90-05			BR8ES	6,35 €	BR8EIX	26,75 €
400	WR400 F	98-01			CR8E	13,85 €	CR8EIX	26,35 €
400	YFM400 FA Kodiak	00-05	HJTX20HQ-FP	242,70 €	DR8EA	6,76 €	DR8EIX	26,35 €
400	YFM400 FP Big Bear	03-05	HJTX20HQ-FP	242,70 €	DR8EA	6,76 €	DR8EIX	26,35 €
400	YFM400 FW Big Bear Pro	00-03	HJTX20HQ-FP	242,70 €	DR8EA	6,76 €	DR8EIX	26,35 €
400	YZ400 F	98-99			CR8E	13,85 €	CR8EIX	26,35 €
426	WR426 F	01-02			CR8E	13,85 €	CR8EIX	26,35 €
426	YZ426 F	00-02			CR8E	13,85 €	CR8EIX	26,35 €
450	WR450 F	03-18	HJTZ75-FP HJTZ75-FPZ	99,20 € 164,30 €	CR8E	13,85 €	CR8EIX	26,35 €
450	WR450 F	19-22	HJTZ75-FP HJTZ75-FPZ	99,20 € 164,30 €	CPR8EA9	18,46 €		
450	YFM450 FA Kodiak	03-06	HJTX20HQ-FP	242,70 €	DR8EA	6,76 €	DR8EIX	26,35 €
450	YFM450 FG Grizzly	07-12	HJTX20HQ-FP	242,70 €	DR7EA	6,95 €	DR7EIX	28,10 €

En ligne, moraco.fr/moraco/documents.



Cyl	Modèle	Année		€ T.T.C.		€ T.T.C.		€ T.T.C.		€ T.T.C.
YAMAHA										
450	YFM450 FWB Kodiak	17-19	ESTX20L-BS	100,90 €	YTX20L-BS YTX20L(FA)	154,10 € 173,60 €	YTX20L-BS YTX20L(FA)	77,90 € 96,90 €		
450	YFM450 FX Wolverine	06-07	ESTX20L-BS	100,90 €	YTX20L-BS YTX20L(FA)	154,10 € 173,60 €	YTX20L-BS YTX20L(FA)	77,90 € 96,90 €		
450	YFZ450 /S	04-08	EST7B-4	63,70 €	YT7B-BS YT7B(FA)	96,10 € 107,70 €	YT7B-4	50,40 €		
450	YFZ450 R	09-18	ESTZ7S	54,90 €	YTZ7S	162,90 €	YTZ7S	43,90 €	F4977	69,30 €
450	YZ450 F	03-17								
450	YZ450 F	18-19								
450	YZ450 F	20-22								
600	YFM600 FWA	98-01	ESTX20L-BS	100,90 €	YTX20L-BS YTX20L(FA)	154,10 € 173,60 €	YTX20L-BS YTX20L(FA)	77,90 € 96,90 €		
660	YFM660 Grizzly	02-08	ESTX20L-BS	100,90 €	YTX20L-BS YTX20L(FA)	154,10 € 173,60 €	YTX20L-BS YTX20L(FA)	77,90 € 96,90 €		
660	YFM660 Raptor	01-05	ESTX14-BS CTX14(FA)	73,90 € 92,80 €	YTX14-BS YTX14(FA)	103,10 € 115,80 €	YTX14-BS YTX14(FA)	51,60 € 79,70 €		
700	YFM700 F Grizzly	07-08	ESTX20L-BS	100,90 €	YTX20L-BS YTX20L(FA)	154,10 € 173,60 €	YTX20L-BS YTX20L(FA)	77,90 € 96,90 €		
700	YFM700 F Grizzly	09-18	ESTX20L-BS	100,90 €	YTX20L-BS YTX20L(FA)	154,10 € 173,60 €	YTX20L-BS YTX20L(FA)	77,90 € 96,90 €		
700	YFM700 R Raptor	06-18	EST9B-4	69,80 €	YT9B-BS YT9B(FA)	132,40 € 138,70 €	YT9B-4	58,80 €		



CATALOGUE ÉLECTRIQUE : Schémas, visuels, spécification et applications



Cyl	Modèle	Année	Sk rich	€ T.T.C.	NGK STANDARD	€ T.T.C.	NGK IRIIDIUM	€ T.T.C.
YAMAHA								
450	YFM450 FWB Kodiak	17-19	HJTX20HQ-FP	242,70 €	DR7EA	6,95 €	DR7EIX	28,10 €
450	YFM450 FX Wolverine	06-07	HJTX20HQ-FP	242,70 €	DR8EA	6,76 €	DR8EIX	26,35 €
450	YFZ450 /S	04-08	HJT98-FP	115,80 €	CR8E	13,85 €	CR8EIX	26,35 €
450	YFZ450 R	09-18	HJTZ7S-FP HJTZ7S-FPZ	99,20 € 164,30 €	CR8E	13,85 €	CR8EIX	26,35 €
450	YZ450 F	03-17			CR8E	13,85 €	CR8EIX	26,35 €
450	YZ450 F	18-19	LFP02	-	CPR8EA9 CPR9EA9	18,46 € 14,26 €	CPR8EIX9 CPR9EIX9	
450	YZ450 F	20-22	LFP02	-	LMAR8G	17,60 €		
600	YFM600 FWA	98-01	HJTX20HQ-FP	242,70 €	DPR8EA9	6,65 €	DPR8EIX9	28,06 €
660	YFM660 Grizzly	02-08	HJTX20HQ-FP	242,70 €	DPR8EA9	6,65 €	DPR8EIX9	28,06 €
660	YFM660 Raptor	01-05	HJT14H-FP	109,90 €	DPR8EA9	6,65 €	DPR8EIX9	28,06 €
700	YFM700 F Grizzly	07-08	HJTX20HQ-FP	242,70 €	CPR7EA9	13,60 €		
700	YFM700 F Grizzly	09-18	HJTX20HQ-FP	242,70 €	CPR7EA9 LMAR6A9	13,60 € 23,40 €		
700	YFM700 R Raptor	06-18	HJT98-FP	115,80 €	CR8E	13,85 €	CR8EIX	26,35 €

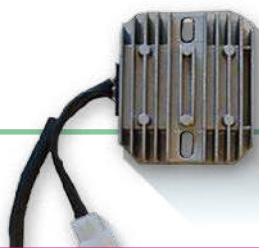

En ligne, moraco.fr/moraco/documents.



BATTERIES



La référence lithium



















Vous pouvez être assuré que lorsque vous achetez une batterie Skyrich, vous obtenez une batterie de qualité supérieure à un prix abordable. Skyrich améliore la qualité et la cohérence de ses produits en continu.



Benjamin MELOT
DAKAR 2021



Équivalence lithium

Référence	TYPE	Equivalence	Dimension LxIxH en mm	Capacité (AH) 10Hr	Poids (Kg)	Puissance (Wh)	Charge (A)		CCA Testé par A R G U S AA500P	Polarité
							STD	MAX		
LFP01		HY85S	92*52*90	2	0,44	24	1	10	120	
S4656	HJB5L-FP	YB4L-A / YB4L-B / YB5L-B / YB7C-A / 12N5-3B / 12N5.5-3B	120*60*92	1,6	0,4	19,2	0,8	8	96	
S4957	HJTZ5S-FP	YTZ5S / YTX4L-BS / YTX5L-BS	113*70*85	2	0,5	24	1	10	120	
S4977	HJTZ7S-FP	YTZ6V / YTZ7S / YTZ7V / YTZ8V	113*70*85	2,4	0,6	28,8	1	12	144	
S4977Z	HJTZ7S-FPZ	YTZ7S / YTX7L-BS	113*70*105	4	0,9	48	2	20	240	
S49107	HJTZ10S-FP	YTZ10S	150*87*93	4	0,9	48	2	20	240	
S49147	HJTZ14S-FP	YTZ12S / YTZ14S	150*87*93	4,5	1,1	60	2,5	22	300	
S492	HJT9B-FP	YT7B-BS / YT7B-4 / YT9B-BS / YT9B-4	150*65*92	3	0,7	36	1,5	15	180	
S4122	HJT12B-FP	YT12B-BS / YT12B-4 / YT14B-BS / YT14B-4 / YB16AL-A2	150*65*130	5	0,9	60	2,5	22	300	
S4856	HJTX5L-FP	YTX4L-BS / YTX5L-BS	113*70*85	1,6	0,4	19,2	0,8	8	96	
S4871	HJTX7A-FP	YTX7A-BS	150*87*93	2,4	0,6	24	1	10	120	
S489	HJTX9-FP	YTX9-BS / YTR9-BS	150*87*105	3	0,7	36	1,5	15	180	
S48145	HJTX14H-FP	YTX14H-BS / YTX14-BS / YTX12-BS / YTX12A-BS	150*87*93	4	1,1	48	2	20	240	
S481415Q	HJTX14AHQ-FP	YTX14AH-BS / YB14-A2 / YB14A-A2 / YB14-B2 / YB14L-A2 / YB14L-B2 / 12N14-3A / YB12A-A / YB12A-B / YB12C-A / 12N12A-4A-1 / YB10L-A2 / YB10L-B / YB10L-B2 / YB10L-BP / YB12AL-A2	134*75*133	5	1,1	48	2	20	240	
S48205Q	HJTX20HQ-FP	YTX20-BS / YB16-B / YB18-A / YTX24HL-BS / YTX15L-BS / YTX18L-BS / YTX20L-BS / YB16L-B / YB16CL-B / YB18L-A / YB18L-A2 / Y50-N18L-A	175*87*130	7	1,7	84	3,5	28	420	
S482035	HJTX20CH-FP	YTX16-BS / YTX16-BS-1 / YTX20CH-BS / YB16B-A / HYB16A-AB	150*87*105	6	1,2	72	3	24	360	
S51913	HJ51913-FP	51814 / 51913 / 52015	181*77*170	7,2	1,7	90	4	28	450	
S4830Q	HJTX30Q-FP	YIX30L-BS / Y60N24-A / Y60N24AL-B / YB30L-B / YB30CL-B / 52515 / 53030 / 53034 / YHD-12	166*123*163	8	2	96	4	32	480	



Un rapport qualité / prix remarquable

Vous recherchez une gamme de batteries abordable sans pour autant sacrifier la qualité ? **La gamme POWER THUNDER répond à vos attentes.** Présente sur le marché depuis plus de quinze ans, la marque Power Thunder répond aux besoins grâce à trois gammes essentielles.



Activées usine (FA)



NOUVEAUTÉ

La gamme FA est une nouvelle version des batteries courantes, destinées à remplacer celles de type « conventionnelles ». FA est une ligne de batteries étanches, activées usine et sans entretien pour une utilisation facilitée.

La batterie FA combine donc 3 atouts majeurs : sécurité, facilité et énergie optimale à long terme.

Principales caractéristiques :

- Prête à l'emploi et facile à installer
- Pas d'entretien et davantage de sécurité
- Puissance et durée de vie augmentée
- Forte résistance aux vibrations
- Montage en toutes positions
- Faibles émissions de gaz

ENERGYSAFE des batteries polyvalentes.



MOTO & POWERSPORT

Pour motos, scooters, quads, ATV/UTV, jetskis et scooters des neiges







LE CHOIX DES PLUS GRANDS CONSTRUCTEURS MONDIAUX.. AVANT ET MAINTENANT.

Les constructeurs motos demandent toujours ce qu'il y a de meilleur et c'est pour cela qu'ils choisissent les batteries YUASA.

Avec plus de 90 ans de développement, chaque batterie fournit le même niveau de performance, de qualité et de fiabilité exigé par le premier équipement.

- Durée de vie jusqu'à quatre fois supérieure aux batteries concurrentes
- Sans maintenance - ne jamais rajouter d'eau mais recharges régulières nécessaires quand non utilisées
- Premium AGM (Absorbed Glass Matt), acide emprisonné
- Scellées, sans renversement possible, plusieurs angles de montage
- Batteries authentiques haute performance, aux standards et exigences premier équipement des grands constructeurs
- Additif Sulphate Stop pour protéger les batteries des dommages liés à la sous-charge
- Fournies remplies et prêtes à l'emploi

Référence YUASA	Tension (V)	Capacité (Ah 10hr)	Capacité (Ah 20hr)	CCA @ -18°C	 (toutes les dimensions en mm ±2 mm)			 Poids avec acide (Kg)	 Volume acide (L)	 Courant charge (Amps)	Bornes (Voir page 29)	Gamme supérieure	Note	Type de pack	Montage éléments
					L	I	H								

Les batteries AGM haute performance

Gamme YTZ - AGM Haute performance sans entretien

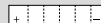
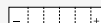
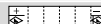
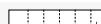

YTZ5S	12	3.5	3.7	65	115	72	86	1.6	0.19	0.1	5			CP	
YTZ6V	12	5	5.3	90	113	70	105	2	0.5	0.5	5			CP	
YTZ7S	12	6	6.3	130	113	70	105	2.1	N/A	0.6	5			WC	
YTZ8V	12	7	7.4	120	113	70	130	2.7	N/A	0.7	5			WC	
YTZ10S	12	8.6	9.1	190	150	87	93	3.2	N/A	0.9	11			WC	
YTZ12S	12	11	11.6	210	150	87	110	3.7	N/A	1.1	11			WC	
YTZ14S	12	11.2	11.8	230	150	87	110	3.9	N/A	1.1	11			WC	

Gamme YTX - AGM Haute performance sans entretien

YTX14AH-BS	12	12	12.6	210	134	89	166	4.9	0.66	1.2	4		(ii)	CP	
YTX14AHL-BS	12	12	12.6	210	134	89	166	4.9	0.66	1.2	4			CP	
YTX14H-BS	12	12	12.6	240	150	87	145	4.8	0.69	1.2	4			CP	
YTX20HL-BS	12	18	18.9	310	175	87	155	6.3	0.93	1.8	4	GYZ20HL		CP	

Batteries AGM sans maintenance

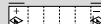
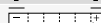
Gamme YTX - AGM sans maintenance

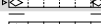
YTX4L-BS	12	3	3.2	50	114	71	86	1.4	0.18	0.4	5			CP	
YTX5L-BS	12	4	4.2	80	115	72	107	2	0.24	0.5	5			CP	
YTX7A-BS	12	6	6.3	105	150	87	93	2.6	0.33	0.6	5			CP	
YTX7L-BS	12	6	6.3	100	115	72	132	2.5	0.33	0.6	5	YTZ8V		CP	
YTX9-BS	12	8	8.4	135	152	87	107	3.1	0.4	0.8	5			CP	
YTX12-BS	12	10	10.5	180	150	87	130	4.2	0.6	1	5			CP	
YTX14-BS	12	12	12.6	200	150	87	145	4.6	0.69	1.2	5	YTX14H-BS		CP	
YTX14L-BS	12	12	12.6	200	150	87	145	4.6	0.69	1.4	5	GYZ16HL		CP	
YTX15L-BS	12	13	13.7	230	175	87	130	4.8	0.69	1.3	4			CP	
YTX16-BS	12	14	14.7	230	150	87	161	5.3	0.78	1.4	4	YTX20CH-BS		CP	
YTX16-BS-1	12	14	14.7	230	150	87	161	5.3	0.78	1.4	1			CP	
YTX20-BS	12	18	18.9	270	175	87	155	6.7	0.93	1.8	4	YTX20H-BS		CP	
YTX20L-BS	12	18	18.9	270	175	87	155	6.7	0.93	1.8	4	YTX20HL-BS		CP	

Gamme YT - AGM sans maintenance

YT4B-BS	12	2.3	2.4	40	114	39	86.5	1.1	0.12	0.3	13			CP	
YTR4A-BS	12	2.3	2.4	45	114	49	86	1.1	0.14	0.3	12			CP	
YT7B-BS / YT7B-4	12	6.5	6.8	110	150	65	93	2.7	0.31	0.7	11			CP	
YT9B-BS / YT9B-4	12	8	8.4	120	150	70	105	3	0.4	0.8	11			CP	
YT12A-BS	12	10	10.5	175	150	87	105	3.5	0.5	1	5			CP	
YT12B-BS / YT12B-4	12	10	10.5	210	150	69	130	4.1	0.5	1	11			CP	
YT14B-BS / YT14B-4	12	12	12.6	210	150	70	145	4.6	0.6	1.2	11			CP	
YT19BL-BS	12	17.7	19	170	186	82	171	5.7	0.95	1.9	10			CP	





(i) Comprend une entretoise de 20mm, requise pour le remplacement d'une YB16CL-B. (ii) Comprend une entretoise de 10mm requise pour le remplacement d'une YB14A-A1 et d'une YB14A-A2.
(iii) Comprend une entretoise de 17mm pour tous les modèles BRP(Sea-Doo) 1500cc 4-stroke, année 2003 et plus.

Référence YUASA	Tension (V)	Capacité (Ah 10hr)	Capacité (Ah 20hr)	CCA @ -18°C	Dimensions (mm) (toutes dimensions en mm ±2 mm)			Poids avec acide (Kg)	Volume acide (L)	Courant charge (Amps)	Bornes (Voir page 29)	Gamme supérieure	Note	Type de pack	Montage éléments
					L	I	H								

Batteries YuMicron CX & Batteries YuMicron

YuMicron															
YB2.5L-C	12	2.5	2.6	15	81	71	106	1	0.25	0.3	-			DC	
YB2.5L-C-2	12	2.5	2.6	15	81	71	106	1	0.24	0.3	-			DC	
YB3L-A	12	3	3.2	30	99	57	111	1.3	0.3	0.3	6			DC	
YB3L-B	12	3	3.2	30	99	57	111	1.3	0.3	0.3	6			CP	
YB4L-A	12	4	4.2	45	120	70	92	1.5	0.3	0.4	5	YTX4L-BS		DC	
YB4L-B	12	4	4.2	45	121	71	93	1.5	0.3	0.4	5	YTX4L-BS		CP	
YB5L-B	12	5	5.3	60	121	61	131	2	0.36	0.5	6			CP	
YB7C-A	12	7	7.4	75	130	90	114	3	0.6	0.8	3			CP	
YB7-A	12	8	8.4	105	136	75	133	3	0.6	0.8	6			CP	
YB7L-B	12	8	8.4	75	135	75	133	2.9	0.6	0.8	6			CP	
YB7L-B2	12	8	8.4	75	135	75	133	2.9	0.6	0.8	4			DC	
YB9A-A	12	9	9.5	115	135	75	155	3.1	0.6	0.9	6			DC	
YB9L-A2	12	9	9.5	100	135	75	139	3.1	0.6	0.9	2			CP	
YB9-B	12	9	9.5	115	137	77	141	3.1	0.6	0.9	6			CP	
YB10L-A2	12	11	11.6	120	135	90	145	4.2	0.8	1.1	8			CP	
YB10L-B	12	11	11.6	120	135	90	145	4	0.8	1.1	6			CP	
YB10L-B2	12	11	11.6	120	135	90	145	4	0.8	1.1	8			CP	
YB12B-B2	12	11	11.6	140	160	90	130	4	0.8	1.2	8			DC	
YB10L-BP	12	12	12.6	165	135	90	145	4	0.8	1.1	6			DC	
YB12A-A	12	12	12.6	150	134	80	160	4.1	0.8	1.2	6			CP	
YB12AL-A	12	12	12.6	150	136	82	162	4	0.8	1.2	6	YB12AL-A2		DC	
YB12AL-A2	12	12	12.6	150	134	80	160	4	0.75	1.2	8		(i)	CP	
YB12A-B	12	12	12.6	150	134	80	160	4	0.75	1.2	6			CP	
YB12C-A	12	12	12.6	150	134	80	175	4.3	0.8	1.2	4			DC	
YB14-A2	12	14	14.7	175	134	89	166	4.6	0.9	1.4	8	YTX14AH-BS		CP	
YB14-B2	12	14	14.7	175	134	89	166	4.6	0.9	1.4	8	YTX14AH-BS		CP	
YB14A-A1	12	14	14.7	175	134	89	176	4.5	0.9	1.4	6	YTX14AH-BS		DC	
YB14A-A2	12	14	14.7	175	134	89	176	4.5	0.9	1.4	8	YTX14AH-BS		CP	
YB14L-A	12	14	14.7	190	134	89	166	4.6	0.9	1.4	6			DC	
YB14L-A1	12	14	14.7	175	134	89	166	4.6	0.9	1.4	1			DC	
YB14L-A2	12	14	14.7	175	136	91	168	4.6	0.9	1.4	8	YTX14AHL-BS		CP	
YB14L-B2	12	14	14.7	175	136	91	168	4.6	0.9	1.4	8	YTX14AHL-BS		CP	
YB16AL-A2	12	16	16.8	210	207	71.5	164	5.3	1.1	1.6	2			CP	
HYB16A-AB	12	16	16.8	190	151	91	180	5	0.9	1.6	7			DC	
YB16B-A	12	16	16.8	207	160	90	161	5.1	1	1.6	4			DC	
YB18-A	12	18	18.9	215	180	90	162	5.8	1.2	1.8	7	YTX20-BS		DC	
YB18L-A	12	18	18.9	215	180	90	162	5.8	1.2	1.8	7	YTX20L-BS		CP	
YB16-B	12	19	20	215	175	100	155	6.3	1.2	1.9	6	YB16-B-CX		CP	
YB16L-B	12	19	20	215	175	100	155	6.3	1.2	1.9	6	YTX20L-BS		CP	
YB16CL-B	12	19	20	240	175	100	175	6.1	1.2	1.9	5	YTX20HL-BS-PW		CP	
Y50-N18L-A3	12	20	21.1	240	205	90	162	7.4	1.4	2	4	YTX24HL-BS		DC	









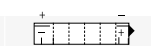
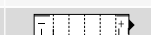
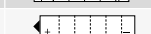
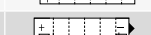
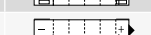
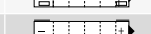
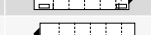
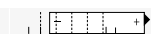
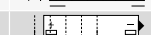
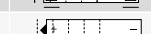
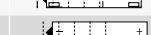
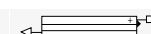
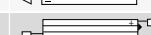

(i) Comprend une entree de 20mm requise pour le remplacement d'une YB16CL-B.
 * Le CCA (Cold Cranking Amps) indique concerne la référence uniquement. Le CCA est une valeur théoriquement calculée. Les performances peuvent varier selon les conditions

Référence YUASA	Tension (V)	Capacité (Ah 10hr)	Capacité (Ah 20hr)	CCA @ -18°C	 (toutes dimensions en mm ±2 mm)			 Poids avec acide (Kg)	 Volume acide (L)	 Courant charge (Amps)	Bornes (Voir page 29)	Gamme supérieure	note	Type de pack	 Montage éléments
					L	I	H								



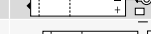

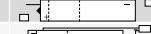
Batteries YuMicron

YuMicron															
SY50-N18L-AT	12	20	21.1	240	205	90	162	6.5	1.4	2	7	YTX24HL-BS		CP	
Y60-N24L-A	12	28	29.5	241	184	124	175	8.6	1.7	2.8	3			CP	
YB30L-B	12	30	31,6	300	168	132	176	8,5	1,7	3	4			DC	
51814	12	-	18	100	186	82	171	5.6	1	1.9	10		*	CP	
51913	12	-	19	100	186	82	171	5.6	1	1.9	10	YT19BL-BS	*	CP	
52015	12	-	20	110	186	82	171	5.6	1	2	10	YT19BL-BS	*	DC	
52515	12	-	25	130	186	130	171	8.4	1.8	2.5	10		*	CP	
53030	12	-	30	180	186	130	171	9.4	1.6	3	10		*	CP	

Batteries conventionnelles

Conventionnelles 12 Volt															
12N5-3B	12	5	5.3	35	120	60	130	2	0.4	0.5	6	YB5L-B		CP	
12N5.5-3B	12	5.5	5.8	55	135	60	130	2.5	0.4	0.6	6			CP	
12N5.5-4A	12	5.5	5.8	55	135	60	130	2.5	0.4	0.6	2			DC	
12N5.5-4B	12	5.5	5.8	55	137	61	131	2.5	0.4	0.6	6			DC	
12N5.5A-3B	12	5.5	5.8	55	103	90	114	2.4	0.5	0.6	6			CP	
12N7-3B	12	7	7.4	70	135	75	133	3	0.5	0.7	6	YB7L-B		CP	
12N7-4A	12	7	7.4	70	135	75	133	3	0.5	0.7	6	YB7-A		CP	
Conventionnelles 12 Volt															
12N9-3B	12	9	9.5	85	135	75	139	3.2	0.6	0.9	6	YB9L-B		CP	
12N9-4B-1	12	9	9.5	85	135	75	139	3.2	0.6	0.9	6	YB9-B		CP	
12N12A-4A-1	12	12	12.6	120	134	80	160	3.7	0.7	1.2	6	YB12A-A		CP	
12N14-3A	12	14	14.7	125	134	89	166	4.5	0.8	1.4	8	YB14L-A2		CP	
Conventionnelles 6 Volt															
6N2-2A	6	2	2.1		70	47	96	0.5	0.1	0.2	-			-	
6N2-2A-4	6	2	2.1		70	47	96	0.5	0.1	0.2	-			-	
6N2A-2C-3	6	2	2.1		70	47	106	0.5	0.1	0.2	-			-	
6N4-2A	6	4	4.2		71	71	96	0.8	0.2	0.4	-			-	
6N4-2A-4	6	4	4.2		71	71	96	0.8	0.2	0.4	-			-	
6N4-2A-5	6	4	4.2		71	71	96	0.8	0.2	0.4	-			-	
6N4-2A-7	6	4	4.2		71	71	96	0.8	0.2	0.4	-			-	
6N4A-4D	6	4	4.2		61	57	131	1	0.2	0.4	-			-	
6N4B-2A	6	4	4.2		102	48	96	1	0.2	0.4	-			-	
6N4B-2A-3	6	4	4.2		102	48	96	1	0.2	0.4	-			-	
6N4C-1B	6	4	4.2		71	71	105	0.8	0.2	0.4	-			-	
6N6-3B	6	6	6.3		99	57	111	1.3	0.3	0.6	6			6	
6N6-3B-1	6	6	6.3		99	57	111	1.3	0.3	0.6	6			6	

(i) Comprend une entretoise de 20mm requise pour le remplacement d'une YB16CL-B.
 * Le CCA (Cold Cranking Amps) indiqué concerne la référence uniquement. Le CCA est une valeur théoriquement calculée. Les performances peuvent varier selon les conditions d'usage

Référence YUASA	Tension (V)	Capacité (Ah 10hr)	Capacité (Ah 20hr)	CCA @ -18°C	 (toutes dimensions en mm ±2 mm)			 Poids avec acide (Kg)	 Volume acide (L)	 Courant charge (Amps)	Bornes (voir ci-dessous)	Gamme supérieure	Note	Type de pack	 Montage éléments
					L	I	H								











































Batteries conventionnelles

Conventionnelles 6 Volt

6N6-1D-2	6	6	6.3	99	57	111	1.2	0.3	0.6	-	DC	
6YB8L-B / 6N83B	6	8	8.4	120	70	95	1.6	0.31	0.8	6	DC	
6N11-2D	6	11	11.6	150	70	100	2	0.4	1.1	6	DC	
6N11A-1B	6	11	11.6	122	62	131	2.1	0.4	1.1	6	DC	
6N11A-4	6	11	11.6	122	62	131	2.1	0.4	1.1	6	DC	
B38-6A	6	13	13.7	119	83	161	2.9	0.62	1.3	6	DC	

* Le CCA (Cold Cranking Amps) indiqué concerne la référence uniquement. Le CCA est une valeur théoriquement calculée. Les performances peuvent varier selon les conditions d'usage

Type de bornes

Type	Face	Côté	Dessus
1			
2			
3			
4			
5			
6			
7			
8			
9			
10			
11			
12			
13			
14			

Batteries : classification et tarifs

CAPACITÉ AH	MARQUE	DÉNOMINATION	NOTE	Référence	€ H.T.	€ T.T.C.
SANS ENTRETIEN SERIE Z						
3,5	YUASA	YTZ5S	ACTIVEE USINE <i>New</i>	Y4957	64,50 €	77,40 €
5	YUASA	YTZ6V	ACTIVEE USINE <i>New</i>	Y4960	92,33 €	110,80 €
6	POWER THUNDER	YTZ7S	ACTIVEE USINE	P4977	34,00 €	40,80 €
6	ES	ESTZ7S	ACTIVEE USINE	E4977	45,75 €	54,90 €
6	FURUKAWA	FTZ7S	ACTIVEE USINE	F4977	45,75 €	54,90 €
6	YUASA	YTZ7S	ACTIVEE USINE	Y4977	135,75 €	162,90 €
7	ES	ESTZ8V	ACTIVEE USINE <i>New</i>	E4980	53,58 €	64,30 €
7	YUASA	YTZ8V	ACTIVEE USINE	Y4980	108,67 €	130,40 €
8	POWER THUNDER	YTZ10S	ACTIVEE USINE	P49107	38,25 €	45,90 €
8	ES	ESTZ10S	ACTIVEE USINE	E49107	79,92 €	95,90 €
8	FURUKAWA	FTZ10S	ACTIVEE USINE	F49107	79,92 €	95,90 €
8	YUASA	YTZ10S	ACTIVEE USINE	Y49107	165,58 €	198,70 €
11	POWER THUNDER	YTZ12S	ACTIVEE USINE	P49127	47,42 €	56,90 €
11	ES	ESTZ12S	ACTIVEE USINE	E49127	87,42 €	104,90 €
11	FURUKAWA	FTZ12S	ACTIVEE USINE	F49127	87,42 €	104,90 €
11	YUASA	YTZ12S	ACTIVEE USINE	Y49127	164,67 €	197,60 €
11,2	POWER THUNDER	YTZ14S	ACTIVEE USINE	P49147	49,92 €	59,90 €
11,2	ES	ESTZ14S	ACTIVEE USINE <i>New</i>	E49147	83,00 €	99,60 €
11,2	FURUKAWA	FTZ14S	ACTIVEE USINE <i>New</i>	F49147	83,00 €	99,60 €
11,2	YUASA	YTZ14S	ACTIVEE USINE	Y49147	179,58 €	215,50 €
SANS ENTRETIEN SERIE B4 ET B-BS						
6,5	YUASA	YT7B-BS	<i>New</i>	Y47227	80,08 €	96,10 €
6,5	POWER THUNDER	YT7B-4	ACTIVEE USINE	P47224	38,92 €	46,70 €
6,5	ES	EST7B-4	ACTIVEE USINE	E47224	53,08 €	63,70 €
6,5	GS BATTERY**	GS GT7B-4		4724	72,17 €	86,60 €
6,5	YUASA	YT7B	ACTIVEE USINE <i>New</i>	Y472FA	89,75 €	107,70 €
8	POWER THUNDER	YT9B-4	ACTIVEE USINE	P4924	45,33 €	54,40 €
8	ES	EST9B-4	ACTIVEE USINE	E4924	58,17 €	69,80 €
8	GS BATTERY*	GS GT9B-4		4924	85,37 €	102,44 €
8	YUASA	YT9B	ACTIVEE USINE <i>New</i>	Y492FA	115,58 €	138,70 €
10	POWER THUNDER	YT12A-BS		P412127	40,50 €	48,60 €
10	POWER THUNDER	YT12A-BS	ACTIVEE USINE <i>New</i>	P4121F	56,08 €	67,30 €
10	ES	EST12A-BS		E412127	63,67 €	76,40 €
10	ES	CTX12A-A	ACTIVEE USINE <i>New</i>	E481211F	68,25 €	81,90 €
10	YUASA	YT12A-BS		Y412127	90,42 €	108,50 €
10	YUASA	YT12A	ACTIVEE USINE <i>New</i>	Y4121FA	99,50 €	119,40 €
10	ES	EST12AB-4 (=EST12A-BS)	ACTIVEE USINE	E412124	64,92 €	77,90 €
10	YUASA	YT12B-BS		Y412227	90,33 €	108,40 €
10	POWER THUNDER	YT12B-4	ACTIVEE USINE	P41224	43,25 €	51,90 €
10	ES	EST12B-4 (=EST12BB4)	ACTIVEE USINE	E41224	65,67 €	78,80 €
10	YUASA	YT12B	ACTIVEE USINE <i>New</i>	Y4122FA	98,33 €	118,00 €
12	YUASA	YT14B-BS		Y414227	134,75 €	161,70 €
12	POWER THUNDER	YT14B-4	ACTIVEE USINE	P41424	56,33 €	67,60 €
12	ES	EST14B-4	ACTIVEE USINE	E41424	74,92 €	89,90 €
12	GS BATTERY*	GS GT14B-4	ACTIVEE USINE	41424	112,81 €	135,37 €
12	YUASA	YT14B	ACTIVEE USINE <i>New</i>	Y4142FA	139,25 €	167,10 €
17,7	YUASA	YT19BL-BS (=51913)		Y4192627	119,83 €	143,80 €
17,7	YUASA	YT19BL (=51913)	ACTIVEE USINE <i>New</i>	Y41926FA	116,50 €	139,80 €

* Jusqu'à épuisement des stocks.

CAPACITÉ AH	MARQUE	DÉNOMINATION	NOTE	Référence	€ H.T.	€ T.T.C.
SANS ENTRETIEN						
2,3	POWER THUNDER	YTR4A-BS		FB48127	27,08 €	32,50 €
2,3	POWER THUNDER	YTR4A-BS	ACTIVEE USINE	FB48127F	19,00 €	22,80 €
3	POWER THUNDER	YTX4L-BS		P44627	13,75 €	16,50 €
3	POWER THUNDER	YTX4L-BS	ACTIVEE USINE New	P4846F	19,75 €	23,70 €
3	ES	ESTX4L-BS		E44627	22,42 €	26,90 €
3	ES	CTX4L	ACTIVEE USINE New	E4846F	23,42 €	28,10 €
3	GS BATTERY*	GS GTX4L-BS		44627	25,84 €	31,01 €
3	YUASA	YTX4L-BS		Y484627	30,25 €	36,30 €
3	YUASA	YTX4L	ACTIVEE USINE New	Y4846FA	32,83 €	39,40 €
4	POWER THUNDER	YTX5L-BS		P485627	18,58 €	22,30 €
4	POWER THUNDER	YTX5L-BS	ACTIVEE USINE New	P4856F	26,92 €	32,30 €
4	ES	ESTX5L-BS		E485627	27,92 €	33,50 €
4	ES	CTX5L	ACTIVEE USINE New	E4856F	31,00 €	37,20 €
4	YUASA	YTX5L-BS		Y485627	54,00 €	64,80 €
4	YUASA	YTX5L	ACTIVEE USINE New	Y4856FA	59,08 €	70,90 €
6	POWER THUNDER	YTX7L-BS		P487627	25,75 €	30,90 €
6	POWER THUNDER	YTX7L-BS	ACTIVEE USINE New	P4876F	36,50 €	43,80 €
6	ES	ESTX7L-BS		E4876122	38,25 €	45,90 €
6	ES	CTX7L	ACTIVEE USINE	E4876122F	41,08 €	49,30 €
6	YUASA	YTX7L-BS		Y487627	58,75 €	70,50 €
6	YUASA	YTX7L	ACTIVEE USINE New	Y4876FA	62,67 €	75,20 €
6	POWER THUNDER	YTX7A-BS		P487127	27,42 €	32,90 €
6	POWER THUNDER	YTX7A-BS	ACTIVEE USINE New	P4871F	35,58 €	42,70 €
6	ES	ESTX7A-BS		E487127	36,58 €	43,90 €
6	ES	CTX7A	ACTIVEE USINE New	E4871F	41,42 €	49,70 €
6	YUASA	YTX7A-BS		Y487127	58,75 €	70,50 €
6	YUASA	YTX7A	ACTIVEE USINE New	Y4871FA	63,17 €	75,80 €
8	POWER THUNDER	YTX9-BS		P48927	26,83 €	32,20 €
8	POWER THUNDER	YTX9-BS	ACTIVEE USINE New	P489F	39,50 €	47,40 €
8	ES	ESTX9-BS		E48927	41,58 €	49,90 €
8	ES	CTX9	ACTIVEE USINE	E48927F	45,75 €	54,90 €
8	ES	YTX9-BS		Y48927	49,50 €	59,40 €
8	YUASA	YTX9	ACTIVEE USINE New	Y489FA	60,33 €	72,40 €
10	POWER THUNDER	YT12A-BS		P412127	40,50 €	48,60 €
10	POWER THUNDER	YT12A-BS	ACTIVEE USINE New	P4121F	56,08 €	67,30 €
10	ES	EST12A-BS		E412127	63,67 €	76,40 €
10	ES	CTX12A-A	ACTIVEE USINE New	E481211F	68,25 €	81,90 €
10	ES	EST12AB-4 (Equivalent EST12A-BS)	ACTIVEE USINE	E412124	64,92 €	77,90 €
10	POWER THUNDER	YTX12-BS		P481227	34,92 €	41,90 €
10	POWER THUNDER	YTX12-BS	ACTIVEE USINE New	P4812F	52,25 €	62,70 €
10	ES	ESTX12-BS		E481227	53,25 €	63,90 €
10	ES	CTX12	ACTIVEE USINE	E481227F	63,25 €	75,90 €
10	YUASA	YTX12-BS		Y481227	66,75 €	80,10 €
10	YUASA	YTX12	ACTIVEE USINE New	Y4812FA	75,00 €	90,00 €
12	POWER THUNDER	YTX14-BS		P481427	39,83 €	47,80 €
12	POWER THUNDER	YTX14-BS	ACTIVEE USINE New	P4814F	61,50 €	73,80 €
12	ES	ESTX14-BS		E481427	57,42 €	68,90 €
12	ES	CTX14	ACTIVEE USINE	E481427F	71,58 €	85,90 €
12	YUASA	YTX14-BS		Y481427	85,92 €	103,10 €
12	YUASA	YTX14	ACTIVEE USINE New	Y4814FA	96,50 €	115,80 €
12	YUASA	YTX14H-BS	New	Y4814527	120,75 €	144,90 €

* Jusqu'à épuisement des stocks.

CAPACITÉ AH	MARQUE	DÉNOMINATION	NOTE	Référence	€ H.T.	€ T.T.C.
SANS ENTRETIEN						
12	YUASA	YTX14L-BS	<i>New</i>	Y4814627	135,58 €	162,70 €
12	GS BATTERY*	GS GTX14AH-BS		48141627	105,14 €	126,17 €
14	POWER THUNDER	GTH16-12 (YTX16-BS)		P451612	54,50 €	65,40 €
14	POWER THUNDER	YTX16	ACTIVÉE USINE <i>New</i>	P4816F	76,83 €	92,20 €
14	ES	CTX16-BS		E481627	62,00 €	74,40 €
14	YUASA	YTX16-BS		Y481627	132,42 €	158,90 €
14	YUASA	YTX16	ACTIVÉE USINE <i>New</i>	Y4816FA	140,17 €	168,20 €
14	POWER THUNDER	YTX16-BS-1		P4516121	60,25 €	72,30 €
14	POWER THUNDER	YTX16-1	ACTIVÉE USINE <i>New</i>	P48161F	76,83 €	92,20 €
14	YUASA	YTX16-BS-1		Y4816271	132,42 €	158,90 €
18	GS BATTERY*	GS GTX18L-BS		4818627	116,72 €	140,06 €
18	YUASA	YTX20-BS		Y482027	143,42 €	172,10 €
18	POWER THUNDER	YTX20A-BS		P4820127	83,17 €	99,80 €
18	POWER THUNDER	YTX20A	ACTIVÉE USINE <i>New</i>	P48201F	116,42 €	139,70 €
18	YUASA	YTX20A-BS		Y4820127	142,92 €	171,50 €
18	POWER THUNDER	YTX20L-BS		P4820627	60,08 €	72,10 €
18	POWER THUNDER	YTX20L-BS	ACTIVÉE USINE <i>New</i>	P48206F	74,75 €	89,70 €
18	ES	ESTX20L-BS		E4820627	78,08 €	93,70 €
18	GS BATTERY*	GS GTX20L-BS		4820627	117,61 €	141,13 €
18	YUASA	YTX20L-BS		Y4820627	128,42 €	154,10 €
18	YUASA	YTX20L	ACTIVÉE USINE <i>New</i>	Y48206FA	144,67 €	173,60 €
18	YUASA	YTX20HL-BS			141,58 €	169,90 €
RENFORCÉES 12V BMW						
18	GS BATTERY*	GS 51814		51814	70,39 €	84,47 €
19	POWER THUNDER	51913		P51913	64,92 €	77,90 €
19	ES	12C16A-3A 51913	<i>New</i>	E51913	72,42 €	86,90 €
19	YUASA	51913		Y51913	89,33 €	107,20 €
20	POWER THUNDER	52015		P52015	74,83 €	89,80 €
20	GS BATTERY*	GS 52015		52015	73,06 €	87,67 €
25	YUASA	52515		Y52515	95,00 €	114,00 €
30	POWER THUNDER	53030		P53030	88,25 €	105,90 €
30	YUASA	53030		Y53030	117,58 €	141,10 €
CONVENTIONNELLES RENFORCÉES 12V						
2,5	YUASA	YB2,5L-C		Y32563	27,17 €	32,60 €
2,5	GS BATTERY*	GS CB2,5L-C-2		325632	31,19 €	37,43 €
3	GS BATTERY*	GS CB3L-A		3361	23,17 €	27,80 €
3	POWER THUNDER	CB3L-B		P3362	13,25 €	15,90 €
3	ES	ESB3L-B		E3362	17,42 €	20,90 €
3	GS BATTERY*	GS CB3L-B		3362	23,17 €	27,80 €
3	YUASA	YB3L-B		Y3362	26,00 €	31,20 €
3	ES	ESB3L-APack acide		E3361	18,25 €	21,90 €
4	GS BATTERY*	GS CB4L-A		3461	24,95 €	29,94 €
4	YUASA	YB4L-A		Y3461	30,42 €	36,50 €
4	POWER THUNDER	CB4L-B		P3462	13,42 €	16,10 €
4	POWER THUNDER	CB4L-BPack acide		P3462PA	13,50 €	16,20 €
4	POWER THUNDER	CB4L-B	ACTIVÉE USINE <i>New</i>	P3462F	17,42 €	20,90 €
4	ES	ESB4L-BPack acide		E3462	19,92 €	23,90 €
4	YUASA	YB4L-B		Y3462	16,92 €	20,30 €
4	YUASA	YTB4L	ACTIVÉE USINE <i>New</i>	Y4246FA	26,00 €	31,20 €
4	YUASA	YB4L-B Pack acide		Y3462PA	20,50 €	24,60 €
5	POWER THUNDER	CB5L-B		P3562	20,50 €	24,60 €

* Jusqu'à épuisement des stocks.

CAPACITÉ AH	MARQUE	DÉNOMINATION	NOTE	Référence	€ H.T.	€ T.T.C.
5	ES	ESB5L-BPack acide		E3562	24,08 €	28,90 €
5	GS BATTERY*	GS CB5L-B		3562	23,79 €	28,55 €
5	ES	CTX5AL	ACTIVEE USINE New	E48516F	29,83 €	35,80 €
5	YUASA	YB5L-B		Y3562	30,67 €	36,80 €
7	POWER THUNDER	CB7C-A		P3731	30,92 €	37,10 €
7	GS BATTERY*	GS CB7-A		371	34,75 €	41,70 €
7	ES	ESB7C-APack acide		E3731	35,75 €	42,90 €
7	YUASA	YB7C-A		Y3731	56,92 €	68,30 €
8	POWER THUNDER	CB7-A		P371	28,17 €	33,80 €
8	ES	ESB7-APack acide		E371	34,83 €	41,80 €
8	YUASA	YB7-A		Y371	43,42 €	52,10 €
8	YUASA	YB7L-B		Y3762	47,92 €	57,50 €
8	GS BATTERY*	GS CB7L-B2		37622	36,53 €	43,84 €
8	ES	ESB7L-B2 Pack Acide		E37622	36,58 €	43,90 €
8	YUASA	YB7L-B2		Y37622	47,92 €	57,50 €
9	GS BATTERY*	GS CB9A-A		3911	39,20 €	47,04 €
9	POWER THUNDER	CB9-B		P392	27,08 €	32,50 €
9	POWER THUNDER	CB9-B	ACTIVEE USINE New	P392F	38,92 €	46,70 €
9	GS BATTERY*	GS CB9-B		392	32,08 €	38,50 €
9	ES	ESB9-B Pack acide		E392	36,42 €	43,70 €
9	YUASA	YB9-B		Y392	37,92 €	45,50 €
9	YUASA	YTB9	ACTIVEE USINE New	Y429FA	46,92 €	56,30 €
9	GS BATTERY*	GS CB9L-A2		39612	44,55 €	53,46 €
11	POWER THUNDER	CB10L-A2		P310612	36,33 €	43,60 €
11	GS BATTERY*	GS CB10L-A2		310612	45,44 €	54,53 €
11	ES	ESB10L-A2 Pack acide		E310612	47,83 €	57,40 €
11	YUASA	YB10L-A2		Y310612	56,33 €	67,60 €
11	POWER THUNDER	CB10L-B		P31062	36,58 €	43,90 €
11	ES	ESB10L-BPack acide		E31062	42,42 €	50,90 €
11	GS BATTERY*	GS CB10L-B		31062	46,33 €	55,60 €
11	YUASA	YB10L-B		Y31062	58,58 €	70,30 €
11	ES	ESB10L-B2 Pack acide		E310622	45,75 €	54,90 €
11	GS BATTERY*	GS CB10L-B2		310622	48,11 €	57,73 €
11	YUASA	YB10L-B2		Y310622	58,58 €	70,30 €
11	GS BATTERY*	GS CB12B-B2		312222	51,68 €	62,02 €
11	YUASA	YB12B-B2		Y312222	63,00 €	75,60 €
12	YUASA	YB10L-BP		Y31062P	67,33 €	80,80 €
12	POWER THUNDER	CB12A-A		P31211	39,58 €	47,50 €
12	GS BATTERY*	GS CB12A-A		31211	46,33 €	55,60 €
12	ES	ESB12A-APack acide		E31211	47,42 €	56,90 €
12	YUASA	YB12A-A		Y31211	62,33 €	74,80 €
12	YUASA	YB12A-B		Y31212	60,58 €	72,70 €
12	POWER THUNDER	CB12A-B2		P31212	43,25 €	51,90 €
12	GS BATTERY*	GS CB12A-B2		31212	49,90 €	59,88 €
12	POWER THUNDER	CB12AL-A2		P3121612	40,75 €	48,90 €
12	POWER THUNDER	CB12AL-A	ACTIVEE USINE New	P312161F	48,25 €	57,90 €
12	GS BATTERY*	GS CB12AL-A2		3121612	44,55 €	53,46 €
12	ES	ESB12AL-A2 Pack acide		E3121612	49,67 €	59,60 €
12	YUASA	YB12AL-A2		Y3121612	53,00 €	63,60 €
12	POWER THUNDER	CB12C-A		P31231	43,25 €	51,90 €
12	GS BATTERY*	GS CB12C-A		31231	51,68 €	62,02 €

* Jusqu'à épuisement des stocks.

CAPACITÉ AH	MARQUE	DÉNOMINATION	NOTE	Référence	€ H.T.	€ T.T.C.
CONVENTIONNELLES RENFORCÉES 12V						
12	YUASA	YB12C-A		Y31231	63,00 €	75,60 €
14	GS BATTERY*	GS CB14A-A1		314111	55,24 €	66,29 €
14	POWER THUNDER	CB14-A2		P31412	49,08 €	58,90 €
14	GS BATTERY*	GS CB14-A2		31412	46,33 €	55,60 €
14	ES	ESB14-A2Pack acide		E31412	50,75 €	60,90 €
14	YUASA	YB14-A2		Y31412	57,83 €	69,40 €
14	POWER THUNDER	CB14A-A2		P314112	49,08 €	58,90 €
14	YUASA	YB14A-A2		Y314112	68,08 €	81,70 €
14	YUASA	YB14L-A		Y31461	67,33 €	80,80 €
14	GS BATTERY*	GS CB14L-A1		314611	50,79 €	60,95 €
14	ES	ESB14-B2Pack acide		E31422	51,00 €	61,20 €
14	GS BATTERY*	GS CB14-B2		31422	51,68 €	62,02 €
14	YUASA	YB14-B2		Y31422	63,25 €	75,90 €
14	POWER THUNDER	CB14L-A2		P314612	44,58 €	53,50 €
12	POWER THUNDER	YTX14AH-L (CB14LA2/ CB14LB2)	ACTIVEE USINE New	P4814156F	62,17 €	74,60 €
14	ES	ESB14L-A2 Pack acide		E314612	50,75 €	60,90 €
14	GS BATTERY*	GS CB14L-A2		314612	50,79 €	60,95 €
14	YUASA	YB14L-A2		Y314612	58,58 €	70,30 €
14	POWER THUNDER	CB14L-B2		P314622	49,92 €	59,90 €
14	POWER THUNDER	YTX14AH-L (CB14LA2/ CB14LB2)	ACTIVEE USINE New	P4814156F	62,17 €	74,60 €
14	GS BATTERY*	GS CB14L-B2		314622	50,79 €	60,95 €
14	ES	ESB14L-B2 Pack acide		E314622	54,08 €	64,90 €
14	YUASA	YB14L-B2		Y314622	63,25 €	75,90 €
16	GS BATTERY*	GS HCB16A-A		531611	92,66 €	111,19 €
19	YUASA	YB16-B		Y3162	102,17 €	122,60 €
19	POWER THUNDER	CB16B-A		P31621	69,75 €	83,70 €
19	YUASA	YB16B-A		Y31621	93,17 €	111,80 €
16	POWER THUNDER	CB16AL-A2		P3161612	49,92 €	59,90 €
16	ES	ESB16AL-A2 Pack acide		E3161612	67,42 €	80,90 €
16	GS BATTERY*	GS CB16AL-A2		3161612	73,06 €	87,67 €
16	YUASA	YB16AL-A2		Y3161612	81,33 €	97,60 €
19	GS BATTERY*	GS CB16L-B		31662	82,86 €	99,43 €
19	YUASA	YB16L-B		Y31662	104,00 €	124,80 €
19	GS BATTERY*	GS CB16CL-B		316362	93,56 €	112,27 €
18	GS BATTERY*	GS CB18-A		3181	84,65 €	101,58 €
18	GS BATTERY*	GS CB18L-A		31861	84,65 €	101,58 €
18	YUASA	YB18L-A		Y31861	104,92 €	125,90 €
18	GS BATTERY*	GS CB18L-A2		318612	84,65 €	101,58 €
20	POWER THUNDER	C50-N18L-A3		P3501861	73,75 €	88,50 €
20	GS BATTERY*	GS C50-N18LA3		3501861	89,10 €	106,92 €
20	YUASA	Y50-N18L-A3		Y3501861	111,25 €	133,50 €
20	YUASA	SY50-N18L-AT		YS35018618	114,08 €	136,90 €
28	GS BATTERY*	GS C60-N24L-A		3602461	97,12 €	116,54 €
28	YUASA	Y60-N24L-A		Y3602461	118,42 €	142,10 €
30	YUASA	YB30L-B	New	Y33062	144,75 €	173,70 €
CONVENTIONNELLES 12V						
5	GS BATTERY*	GS 12N5-3B		2532	26,73 €	32,08 €
5	YUASA	12N5-3B		Y2532	32,58 €	39,10 €
5,4	GS BATTERY*	GS 12N5.5-4B		25542	27,62 €	33,14 €
5,5	YUASA	12N5,5-3B		Y25532	35,25 €	42,30 €
5,5	GS BATTERY*	GS 12N5,5A-3B		255132	32,97 €	39,56 €

* Jusqu'à épuisement des stocks.

CAPACITÉ AH	MARQUE	DÉNOMINATION	NOTE	Référence	€ H.T.	€ T.T.C.
CONVENTIONNELLES 12V						
5,5	YUASA	12N5.5A-3B		Y255132	40,25 €	48,30 €
5,5	YUASA	12N5,5-4A		Y25541	36,08 €	43,30 €
7	POWER THUNDER	12N7-3B (CB7L-B)		P2732	27,08 €	32,50 €
7	GS BATTERY*	GS 12N7-3B		2732	29,40 €	35,28 €
7	YUASA	12N7-3B		Y2732	36,00 €	43,20 €
7	YUASA	12N7-4A		Y2741	35,17 €	42,20 €
9	GS BATTERY*	GS 12N9-3B		2932	38,31 €	45,97 €
9	YUASA	12N9-3B	New	Y2932	47,00 €	56,40 €
9	POWER THUNDER	12N9-4B-1		P29421	32,42 €	38,90 €
9	GS BATTERY*	GS 12N9-4B-1		29421	38,31 €	45,97 €
9	YUASA	12N9-4B-1	New	Y29421	46,92 €	56,30 €
12	GS BATTERY*	GS 12N12A-4A-1		2121411	47,22 €	56,66 €
12	YUASA	12N12A-4A-1		Y2121411	57,58 €	69,10 €
13	GS BATTERY*	GS B38-6A		23861	35,64 €	42,77 €
13	YUASA	B38-6A		Y23861	45,17 €	54,20 €
14	GS BATTERY*	GS 12N14-3A		21431	49,90 €	59,88 €
14	YUASA	12N14-3A		Y21431	60,83 €	73,00 €
16	GS BATTERY*	GS 12N16-3B		21632	53,46 €	64,15 €
24	YUASA	12N24-3A		Y22431	92,33 €	110,80 €
29	YUASA	YHD-12		Y354412	123,00 €	147,60 €
CONVENTIONNELLES 6V						
2	GS BATTERY*	GS 6N2A-2C		12123	14,52 €	17,42 €
2	GS BATTERY*	GS 6N2A-2C-3		121233	14,52 €	17,42 €
2	YUASA	6N2A-2C-3		Y121233	17,67 €	21,20 €
2	GS BATTERY*	GS 6N2-2A-4		12214	11,58 €	13,90 €
2	YUASA	6N2-2A-4		Y12214	14,17 €	17,00 €
2	GS BATTERY*	GS 6N2-2D		1224	12,47 €	14,96 €
4	GS BATTERY*	GS 6N4A-4D		14144	16,30 €	19,56 €
4	GS BATTERY*	GS 6N4-2A		1421	13,19 €	15,83 €
4	YUASA	6N4B-2A		Y14221	22,58 €	27,10 €
4	YUASA	6N4C-1B		Y14312	23,25 €	27,90 €
4	GS BATTERY*	GS 6N4-2A-4		14214	13,19 €	15,83 €
4	YUASA	6N4-2A-4		Y14214	16,08 €	19,30 €
4	GS BATTERY*	GS 6N4-2A-5		14215	13,19 €	15,83 €
4	YUASA	6N4-2A-5		Y14215	16,08 €	19,30 €
4	YUASA	6N4-2A-7		Y14217	17,08 €	20,50 €
4	GS BATTERY*	GS 6N4B-2A-3		142213	17,96 €	21,55 €
6	YUASA	6N6-1D-2		Y16142	23,42 €	28,10 €
6	GS BATTERY*	GS 6N6-3B		1632	18,23 €	21,88 €
6	YUASA	6N6-3B		Y1632	22,83 €	27,40 €
6	GS BATTERY*	GS 6N6-3B-1		16321	18,23 €	21,88 €
6	YUASA	6N6-3B-1		Y16321	22,83 €	27,40 €
8	GS BATTERY*	GS 6N8-3B		1832	24,95 €	29,94 €
11	GS BATTERY*	GS 6N11A-1B		111112	33,86 €	40,63 €
11	GS BATTERY*	GS 6N11A-4A		111141	33,86 €	40,63 €
11	YUASA	6N11A-4		Y111141	42,42 €	50,90 €
11	YUASA	6N11-2D		Y11124	41,33 €	49,60 €
12	YUASA	6N12A-2C/B54-6		Y112123	45,17 €	54,20 €

* Jusqu'à épuisement des stocks.

CHARGEURS DE BATTERIES

NOUVEAUTÉ



La puissance, sans compromis !

ENERGYSAFE, batteries polyvalentes, mais aussi des chargeurs adaptés à vos besoins au rapport qualité prix irrécusable !

Chargeur PREMIUM

NOUVEAUTÉ



Chargeur ES premium* - PREMIUM14

44,90 €
T.T.C.

Chargeur Premium intelligent pour batteries 6V / 12V. 6 modes sélectionnables pour une charge efficace de la batterie.

L'appareil utilise une charge spéciale en 10 étapes qui protège et régénère la batterie. L'écran LCD affiche l'état de charge de la batterie. Mode fonction mémoire.

Protection contre : la surcharge, l'inversion de polarité, la surchauffe et les courts-circuits.



6V/12V 1A/4A
1,2 - 120 Ah



Chargeur SMART

NOUVEAUTÉ



Chargeur ES smart* - SMARTI

34,90 €
I.T.C.

6V/12V 1A
0,8 - 14 Ah



Chargeur de batterie intelligent avec contrôle par microprocesseur.

Activation à faible voltage 2V.

Sécurité anti-électrisation lorsque le chargeur est branché au secteur.

Fonction mémoire de charge.

Sélection 6-12V avec indicateurs LED.

Courant de charge constant 1A

ES
ENERGYSAFE
BATTERY





La référence lithium

Vous pouvez être assuré que lorsque vous achetez une batterie Skyrich, vous obtenez une batterie de qualité supérieure à un prix abordable. Skyrich améliore la qualité et la cohérence de ses produits en continu.

Fournisseur officiel de Ducati, KTM et Husqvarna.



Chargeur lithium

Chargeur intelligent dédié aux batteries lithium.



12V 2A LFP 50/60Hz

Chargeur lithium* - HBC-LF0202

82,80 €
T.T.C.

Chargeur intelligent dédié aux batteries lithium

Il peut évaluer l'état de la batterie et sélectionner automatiquement le programme de charge approprié. Fonction de récupération de tension inférieure, de charge à courant constant, de charge à tension constante et de charge de maintenance.

Protection contre les courts-circuits, l'inversion de polarité, les hautes tensions et les fortes intensités.

Connectivité SAE, compatible avec les accessoires Tecmate.

Certifications : UL, CE, ROHS, TUV, SAA, FCC, CUL, PSE

Chargeur SKYRICH

Puissance, sécurité et longévité.

Réputé pour ses batteries Powersport lithium-ion hautes performances et ultra légères, Skyrich vous propose son chargeur de batterie spécial lithium pour un entretien et une charge optimale.



CHARGEURS TESTEURS

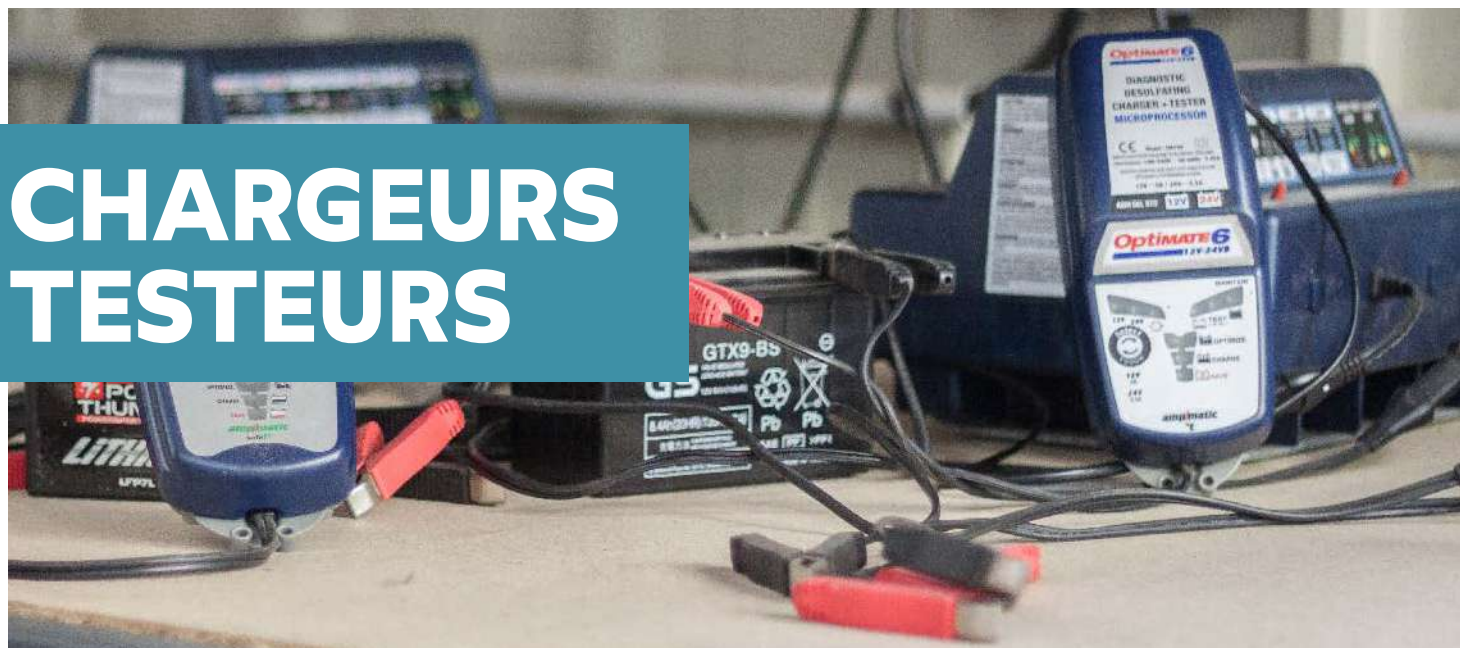

Une qualité sans faille

Optimate

TecMate met au point et fabrique des outils, qui permettent de charger, tester et entretenir des batteries.

La supériorité d'optimate en 4 points

- **RÉALISATION DE TESTS** de l'état de la batterie au moment du raccordement et après la charge sur certains modèles avancés
- **PROGRAMME DE MAINTENANCE UNIQUE et sûre** : 24h/24, 7j/7 et 365j/an, le maintien de la charge à 100% garantit l'allumage du faisceau électrique.
- **ÉGALISATION DES CELLULES DE BATTERIE** : méthode unique par impulsions « sans gazage » chargeant complètement chaque cellule pour des performances supérieures garanties.
- **RÉCUPÉRATION DES BATTERIES « MORTES » QUE LES AUTRES CHARGEURS NE PEUVENT SAUVER** : à basse tension avec charge de récupération par impulsions. Les modèles avancés comportent un mode de **RÉCUPÉRATION « DE SECOURS »** pour les batteries fortement déchargées / sulfatées.

Bien choisir son chargeur

Les chargeurs OptiMate correspondent au type et à la taille de la batterie couramment rencontrés dans les véhicules associés.



Tension de la batterie adaptée au chargeur OptiMate.

12V 1A

Courant de charge maximum

8/9 ÉTAPES

3 - 50 Ah

Étapes : phases de test, de charge et de récupération.
Capacité de charge en ampère heure, Ah.

25 ANS D'EXPÉRIENCE
AU SERVICE
DU MOTARD

Chargeurs entretien

Plomb Acide **DUO** Lithium

Chargeurs « DUO » pour batteries plomb-acide ET lithium

Les batteries lithium sont sensibles aux surcharges et aux décharges profondes. Les décharges importantes peuvent conduire à la surchauffe et à la fonte de la batterie. Un chargeur de batterie plomb-acide pourrait endommager une batterie au lithium.

La gamme duo permet de **charger et d'entretenir tous types de batteries** de manière automatique et en toute sécurité.

$$DUO = \begin{matrix} \text{Standard} \\ 12V \\ \text{Pb} \end{matrix} + \begin{matrix} \text{Lithium} \\ 12.8V \\ \text{Li} \end{matrix}$$

NOUVEAUTÉ

Optimate 2
Duo 12V2A

TM550

Plomb Acide **DUO** Lithium



Standard 12V Pb + Lithium 12.8V Li



12V 2A / 6-96Ah

5 ÉTAPES

12,8V-13,2 2A / 2-24Ah

Le chargeur-mainteneur lithium ou plomb !

Ampérages / tension de charges : 2A / 4V – 14,4V

S'adapte automatiquement aux batteries Pb ou LFMaintenance sûre, 24h/24, 7j/7.

Pas de surcharge. Sécurisé pour l'électronique des véhicules. Arrêt en cas de court-circuit ou batterie déconnectée.



2 DUO* - TM550

82,90 € I.T.C.

Optimate 1
Duo

TM402D

Plomb Acide **DUO** Lithium



TOP VENTES

Standard 12V Pb + Lithium 12.8V Li

12V 0,6A / 2-29Ah

4 ÉTAPES

12,8V-13,2 0,6A / 1-8Ah



1 duo* - TM402D

50,90 € I.T.C.

Optimate 1

TM400A

voltmatic

NOUVEAUTÉ



6V-12V 0.6A

4 ÉTAPES

2 - 28 Ah



1 Voltmatic* - TM400A

47,90 € I.T.C.

Optimate 2

TM420



12V 0.8A

4 ÉTAPES

3 - 96 Ah



2* - TM420

64,90 € I.T.C.

* Eco-participation 0,42 € H.T.

Chargeurs Lithium

Les batteries lithium, sensibles aux surcharges et décharges profondes nécessitent un chargeur adapté.

Les décharges importantes entraînent une surchauffe et la fonte de la batterie.

Optimate LFP
lithium 4s 0.8A

TM470



12.8V 0.8A
8 ÉTAPES
2,5-30Ah

Le chargeur LiFePO4 professionnel destiné à la moto

Charge les batteries LiFePO4/LFP (lithium-ferro-phosphate), dont la tension nominale est comprise entre 12,8 V – 13,2 V.

Entretient et protège les batteries LiFePO4 à basse tension. Cycle de charge LiFePO4 spécialisé. Réinitialisation du BMS de la batterie.

Aucun risque de surcharge pour l'électronique du véhicule. Suppression des étincelles. Maintenance longue durée de la batterie extinction automatique en cas de court-circuit ou si la batterie est débranchée.



LFP* - TM470

75,90 €
T.T.C.

NOUVEAUTÉ

Optimate 2
DUO 12V 2A

TM550

Plomb Acide **DUO** Lithium



2 DUO* - TM550

82,90 €
T.T.C.

Standard 12V Pb + Lithium 12.8V LI



12V 2A / 6-96Ah
5 ÉTAPES
12,8V-13,2 2A / 2-24Ah



Optimate 1
(DUO)

TM402D

Plomb Acide **DUO** Lithium



1 duo* - TM402D

50,90 €
T.T.C.



Standard 12V Pb + Lithium 12.8V LI

12V 0,6A / 2-29Ah
4 ÉTAPES
12,8V-13,2 0,6A / 1-8Ah



NOUVEAUTÉ

Optimate PRO TM390
lithium



☂
12.8V 5A
10 ÉTAPES
2,5-100Ah

Pro* - TM390

153,90 €
T.T.C.

Optimate select TM270
lithium



☂ ❄️
12.8V 9.5A
10 ÉTAPES
16V 7.5A
2-120Ah

Select V2* - TM270

189,90 €
T.T.C.

Chargeur spécial lithium

Les batteries lithium sont sensibles aux surcharges et aux décharges profondes. Les décharges importantes peuvent conduire à la surchauffe et à la fonte de la batterie.

Un chargeur de batterie plomb-acide pourrait endommager une batterie au lithium.



* Eco-participation 0,42 € H.T.

Chargeurs entretien et récupération

Optimate 4 Dual program

TM340



12V 1A
9 ÉTAPES
3-50Ah



Optimate 4* - TM340

85,90 €
T.T.C.

Optimate 4 Canbus* - TM350

93,90 €
T.T.C.

Optimate 4 Dual program CAN Bus

TM350



12V 1A
8/9 ÉTAPES
3-50Ah

Le plus avancé et le plus fiable. Édition CANBUS pour motos BMW.

Chargez, testez et entretenez votre batterie 12V (STD, AGM, GEL). Permet de sauver les batteries sulfatées « mortes ». Tests avancés et précis avant et après la charge.

L'OptiMate 4 Dual Program édition CANBUS comprend deux programmes de charge.
Programme 1 : destiné aux charges directes d'une batterie
Programme 2 : charge sans surveillance et en toute sécurité **via une prise 12 V contrôlée par le bus CAN d'une moto BMW.**

Fonctions avancées du programme CANBUS : activation automatique SANS CLÉ et maintenance continue jusqu'à la déconnexion du chargeur.

Optimate 3

TM430



12V 0,8A
7 ÉTAPES
2,5-50Ah



Optimate 3* - TM430

74,90 €
T.T.C.

Optimate 5 start/stop

TM220



12V 4A
6 ÉTAPES
15-192Ah



Optimate 5* - TM220

96,90 €
T.T.C.

Récupération de batterie

La décharge profonde d'une batterie sous la tension recommandée peut conduire à une sulfatation rapide des batteries plomb-acide et à un déséquilibre des cellules des batteries au lithium.

Les chargeurs OptiMate comportent tous une étape de RÉCUPÉRATION par impulsions à basse tension, tandis que les chargeurs OptiMate plus avancés sont capables de récupérer des batteries que les autres chargeurs ne peuvent sauver.

Chargeurs motos et autres véhicules

OptiMATE 6
ampmatic

TM180



12V 5A

9 ÉTAPES

3 - 240 Ah

OptiMATE 6
select

TM360



NOUVEAUTÉ



12V 6A

9 ÉTAPES

3 - 144 Ah



ampmatic



Optimate 6 TM180* - 0M6EU

132,90 €
I.T.C.

Optimate 6 Ampmatic* - TM360

139,90 €
I.T.C.

Disponible premier semestre 2022

OptiMATE 6
select

TM370



NOUVEAUTÉ



12V 6A

9 ÉTAPES

3 - 240 Ah

Optimate 6 Select* - TM370

150,90 €
I.T.C.

Le chargeur de batterie 12 V entièrement automatique le plus avancé au monde !

OptiMate 6 récupère les batteries que d'autres chargeurs n'arrivent pas à prendre en charge, car il reconnaît la différence entre une batterie déchargée qui a besoin d'être rechargée et une batterie sulfatée complètement à plat qui doit être récupérée.

Version GOLD

OptiMate 6 select permet de choisir la tension de charge administrée à la batterie via le bouton Power Supply.

Chargeurs motos et autres véhicules

Optimate 5 voltmatic TM320



Optimate 5* - TM320

99,90 €
T.T.C.

Optimate 7 12-24V TM260

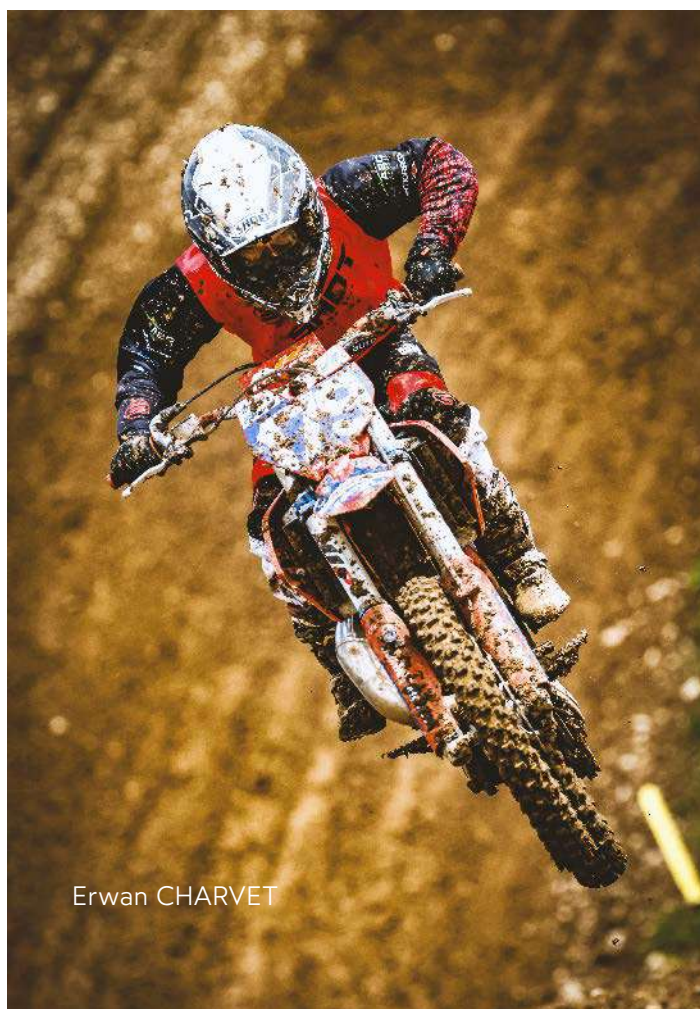

Optimate 7 V3* - TM260

188,90 €
T.T.C.

Erwan CHARVET

AmpMatic

Les modèles OptiMate AmpMatic constituent des chargeurs polyvalents parfaits pour les batteries de toute taille. Le courant de charge est adapté en fonction de la taille et de l'état de la batterie.

VoltMatic

La tension de charge est sélectionnée de manière automatique selon la tension de la batterie connectée.

Alimentation solaire

Optimate
solar

 Plomb Acide **DUO** Lithium

NOUVEAUTÉ
TM522D1
10 W_{att}

6 ÉTAPES 12V STD / 12,8V Li 0.8A / 2-240Ah

Chargeur solaire avec maintenance intelligente : chargeur le jour, contrôleur la nuit!

Récupère les batteries à partir de 4V grâce à son action par impulsions unique. Charge plus rapide, "smart charge" : sélectionne le type de charge en fonction de l'intensité des rayons du soleil.

Maintenance intelligente – continue le lendemain si la batterie a conservé la charge pendant la nuit sinon le programme revient à l'étape OPTIMISATION.

L'état de la batterie s'affiche toutes les 3 secondes. Indication prête pour les batteries standard, AGM hautes performances et batteries lithium LFL mode contrôle consomme moins de 0,5mA. Bascule automatiquement en mode CHARGE lorsque l'énergie solaire est suffisante.

Ampérage de charge : 0,83A (courant moyen) / impulsions 3-5 A.

Puissance du panneau solaire 10W

Solar Duo 10W* - TM522D1
140,90 €
T.T.C.

Optimate
solar

 Plomb Acide **DUO** Lithium

NOUVEAUTÉ
TM522D2
20 W_{att}

6 ÉTAPES 12V STD / 12,8V Li 0.8A / 2-240Ah

Chargeur-Mainteneur-Récupérateur de batterie solaire étanche 12V / 12.8V 1.67A en 6 étapes

Panneau solaire :

Puissance 20W, tension 12V / 12.8V

Usage en extérieur et avec des températures négatives possibles.

Châssis en aluminium résistant aux intempéries avec 4 éléments de fixation, câble de sortie 200 cm avec connecteur SAE

Contrôleur de charge OptiMate :

Ampérage de charge : 1,67A (courant moyen), impulsions 3-5 A.

Récupération : démarrage basse tension à partir de 4V

Éléments fournis : Fil de batterie étanche, kit de pinces de batterie standard, **panneau solaire 20W**

Aucun risque de surcharge, totalement sûr pour l'électronique du véhicule. Maintenance longue durée de batterie en toute sécurité.

Solar Duo 20W* - TM522D2
153,50 €
T.T.C.

Chargeurs d'atelier

Optimate PRO-S ampmatic

TS170



12V 2/4A

3 MODES DE CHARGE

2-40Ah

Optimate PRO-S* - TS170SAE

238,30 €
I.T.C.

NOUVEAUTÉ

Optimate PRO-2 ampmatic

TS180



12V 2A x2

CHARGE AUTOMATIQUE

2-100Ah

Optimate PRO-2* - TS180VDE

283,20 €
I.T.C.

Optimate PRO-4 ampmatic

TS52



12V 2/4A x4

3 MODES DE CHARGE

2-40Ah

Optimate PRO-4* - TS52VDE

1010,80 €
I.T.C.

Optimate PRO-8

TS44



6/12V 1A x8

2 MODES DE CHARGE

2-48Ah

Optimate PRO-8* - TS44VDE

1050,60 €
I.T.C.

Gamme PRO

Chargeurs avec récupération de batterie recommandés par les équipementiers de première monte. Ils constituent l'outil idéal pour la récupération et l'activation adéquates de batteries neuves.

Il permet également de charger et de tester des batteries basse tension ou non entretenues et sulfatées.

Chargeurs d'atelier

NOUVEAUTÉ

Optimate 3 x2
DUAL BANK

TM450

- STD
- AGM
- GEL
- 2V



12V 0.8A
7 ÉTAPES
2,5-50Ah

TM450* - 630070M32

149,90 €
T.T.C.

Optimate 3 x4
QUAD BANK

TM454

- STD
- AGM
- GEL
- 2V



12V 0.8A
7 ÉTAPES
2,5-50Ah

TM454* - 630070M34

295,90 €
T.T.C.

Optimate LFP
lithium 4s 0.8A x4
QUAD BANK

TM484

- LFP
- 0.5V



12.8V 0.8A
8 ÉTAPES
2-30Ah

LFP x4* - TM484

294,50 €
T.T.C.

Optimate 2 x2
DUO 12V 2A DUAL BANK

TM570

- STD
- AGM
- GEL
- EFB
- LFP
- 4V

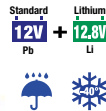

12V 2A / 6-96Ah
5 ÉTAPES
12,8V-13,2 2A / 2-24Ah

2 DUO x2* - TM570

144,90 €
T.T.C.

Optimate 2 x4
DUO 12V 2A QUAD BANK

TM574

- STD
- AGM
- GEL
- EFB
- LFP
- 4V

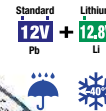

12V 2A / 6-96Ah
5 ÉTAPES
12,8V-13,2 2A / 2-24Ah

2 DUO x4* - TM574

300,90 €
T.T.C.

* Eco-participation 0,42 € H.T.

Alimentation 12 V

OptiMATE 12V
DC → DC 12V 2A

Plomb Acide **DUO** Lithium



LE chargeur et mainteneur hors réseau !

Alimenté à partir d'une source 12V courant continu, chargez et maintenez automatiquement votre batterie plomb-acide 12V (AGM, GEL ou STD) ou votre batterie 12.8V / 13.2V LiFePO4 / LF

Le chargeur de secours idéal pour votre batterie déchargée ou pour la réinitialisation du BMS de votre batterie au lithium.

12V 2A

6 ÉTAPES

12.8V 2A

6 - 96 Ah

STD AGM GEL LFP

2V DEEP CYCLE ECO

Optimate 12 V* - TM500

114,90 €
T.T.C.

Testeurs

OptiMATE 120
test



Pour batteries

12V plomb-acide et
12.8V / 13.2V Lithium

ET alternateur

Vérifier la tension du circuit
de charge.

Optimate 120* - TS120 55,90 €
T.T.C.

OptiMATE 126
test



Pour batteries

12V plomb-acide et
12.8V / 13.2V Lithium

Optimate 126* - TS126 55,90 €
T.T.C.

À chaque pictogramme sa signification

TYPE ET TAILLE DE LA BATTERIE

2-30Ah

Types de batterie adaptés, avec une plage de capacité en ampères-heure.

AGM GEL STD

EXPLICATION DES DIFFÉRENTS TYPES :

PLOMB-ACIDE : le plomb (disposé sous la forme de plaques) réagit avec l'électrolyte liquide (principalement de l'acide sulfurique - H₂SO₄) afin de produire de l'électricité.

STD Les batteries STD, également connues sous le nom de batteries « à électrolyte liquide » ou « à liquide », sont pour la plupart dotées de bouchons de remplissage destinés à ajouter de l'eau distillée. L'électrolyte liquide constitue une combinaison d'acide sulfurique et d'eau pure. Charge = de 12,5 à 12,6 V.

EFB Les batteries STD « à électrolyte liquide » avancée optimisée pour les applications de démarrage moteur fréquentes dans les voitures dotées de la technologie « ECO » START/STOP. Charge = de 12,6 à 12,8 V.

GEL Une batterie VRLA*/scellée avec électrolyte et une combinaison de gel liquide et acide qui inhibe la condensation naturelle. Les batteries GEL sont particulièrement prisées dans les applications à faible courant/veille. Charge = de 12,6 à 12,8 V.

AGM (Absorbed glass mat of VRLA* construction): l'électrolyte à base d'acide sulfurique haute concentration est suspendu dans les fibres de verre placées entre les plaques de plomb, ce qui se traduit par une conception de batterie plus compacte. Le type AGM est prédominant en sport motorisé et constitue une option de batterie haut de gamme populaire dans les secteurs automobile et maritime. La charge à sec est réservée aux sports motorisés, et la batterie est livrée avec un pack acide. La batterie AGM activée en usine reçoit de l'acide et est scellée à la source. Charge = de 12,7 à 12,9 V.

*VRLA - Les batteries scellées (également connues sous le nom de VRLA = batteries plomb-acide régulées par soupape) comportent une soupape régulatrice de pression qui libère en permanence l'électrolyte sous forme de gaz en cas de surcharge.

LFP Batteries au lithium-ferro-phosphate composées de quatre cellules connectées en série, utilisées pour les applications de cycle prolongé et de démarrage, d'éclairage et d'allumage. Les batteries LFP livrent 3 à 4 fois la puissance de démarrage d'une batterie plomb-acide de taille similaire, avec une profondeur de décharge de 90 %, par rapport à 50-75 % pour les batteries plomb-acide. Charge = de 13,6 à 13,8 V.

Les batteries LFP sont sensibles aux surcharges et aux décharges profondes. Les importantes décharges peuvent conduire à la surchauffe et à la fonte de la batterie. Un chargeur de batterie plomb-acide dédié pourrait endommager une batterie au lithium.

BATTERIE/APPLICATION SPÉCIFIQUE - Informations sur les chargeurs de batterie OptiMATE spécifiquement conçus pour répondre aux exigences suivantes :

ECO Voitures dotées de la technologie d'économie de carburant START/STOP, voitures électriques/essence hybrides avec une batterie de 12 V pour démarrer le moteur, véhicules, engins ou équipements avec consommation électrique par intermittence.



Batteries STD, GEL, AGM ou LFP conçues pour livrer un courant constant durant une période prolongée. Les batteries nécessitent une recharge précise et complète après chaque cycle d'utilisation.



Batteries AGM activées en usine haut de gamme destinées au secteur automobile ou automobile maritime/maritime, fabriquées par OptiMa, Odyssey et North Star, nécessitant un courant de recharge supérieur et une tension de charge jusqu'à 14,7 V.

RECHARGE PLUS RAPIDE - Optez pour un chargeur qui livre un courant correspondant aux exigences maximales de la batterie (généralement pour les batteries plomb-acide = 1 dixième de la capacité nominale en Ah ; ou pour les batteries au lithium, 1 fois la capacité nominale en Ah) ou déterminez vos exigences en matière de durée de recharge à partir d'une batterie plate.

TEMPS DE CHARGE - Un chargeur OptiMATE 1 (0,6 A) nécessite 16 à 17 heures pour recharger une batterie de 10 Ah plate, mais 100 heures pour une batterie de voiture de 60 Ah. Calcul : 10 Ah/0,6 A = 16,66 h ou 60 Ah/0,6 A = 100 heures
Un chargeur OptiMATE 6 (5 A) a besoin de 12 heures pour charger une batterie de 60 Ah.

MAINTENANCE DE BATTERIE - Tous les chargeurs OptiMATE conviennent parfaitement pour la maintenance de batterie sur le long terme, mais les chargeurs marqués pour le mode ECO, CYCLE PROLONGÉ (cellule cyclique) et LFP comportent différents programmes de maintenance spécifiques à l'application ou au type de batterie. Une batterie chargée à 100 % ne nécessite pas plus de 10-20 mA pour rester pleinement chargée, mais les véhicules, engins ou faisceaux électriques des équipements toujours actifs peuvent puiser davantage de courant.

RÉCUPÉRATION DE BATTERIE - La décharge profonde d'une batterie sous la tension recommandée peut conduire à une sulfatation rapide des batteries plomb-acide et à un déséquilibre des cellules des batteries au lithium. Les chargeurs OptiMATE comportent tous une étape de RÉCUPÉRATION par impulsions à basse tension, tandis que les chargeurs OptiMATE plus avancés sont capables de récupérer des batteries que les autres chargeurs ne peuvent sauver.

Récupération faible voltage - La tension à partir de laquelle le chargeur OptiMATE est capable de récupérer une batterie profondément déchargée. (1 V = à partir de 1 volt.)

KIT DE SECOURS pour les batteries plomb-acide GEL, AGM et STD - Le mode de récupération DE SECOURS unique d'OptiMATE pour les batteries plomb-acide constitue une combinaison d'impulsions à basse fréquence qui décomposent le sulfate de plomb cristallisé et de tension supérieure contrôlée destinée à forcer la pénétration de courant, ce qui permet de récupérer la batterie plomb-acide afin qu'elle puisse à nouveau être chargée et maintenir la charge.

KIT DE SECOURS POUR batteries au LITHIUM - Le mode de récupération DE SECOURS unique d'OptiMATE pour les batteries au lithium constitue une combinaison de faible courant contrôlé et de suivi de courbe de charge de tension qui permet de faire correspondre la tension de la batterie à la courbe de charge idéale pour les cellules LiFePO₄.

TEST DE LA BATTERIE - Tous les chargeurs OptiMATE testent la batterie au moment du raccordement afin de déterminer le mode de charge adéquat. Les modèles avancés exécutent un test et affichent un résultat après la charge. Les chargeurs OptiMATE 4, 6 et 7, Lithium 4s 5 A et Lithium Select réalisent un test de 10 secondes et affichent un résultat avant la charge.

✓✗ Test BON/MAUVAIS après la charge.

✓|||✗ Test avancé avec 6 résultats avant et après la charge.

CARACTÉRISTIQUES OPTIMATE UNIQUES :

ampmatic Les modèles OptiMATE AmpMatic constituent des chargeurs polyvalents parfaits pour les batteries de toute taille. Le courant de charge est adapté en fonction de la taille et de l'état de la batterie.

voltmatic La tension de charge est automatiquement sélectionnée selon la tension de la batterie connectée.

t° La charge est régulée en fonction de la température ambiante, de 20 °C/68 °F, à -4 mV/°C/cellule.

safeT° Pour prévenir les dommages, le chargeur OptiMATE Lithium s'arrête si la température chute en dessous de -20 °C/4 °F ou dépasse les 45 °C/113 °F.

BMS BMS Réinitialisation du système de gestion de batterie (avec protection basse tension) dans une batterie LFP (lithium-ferro-phosphate).

❄️ Convient aux températures basses allant jusqu'à -40 °C/-40 °F. Tous les autres chargeurs fonctionnent jusqu'à -20 °C/-4 °F.

☂️ Le chargeur est résistant aux intempéries (min. IP54) et est adapté à une utilisation en extérieur.

CARACTÉRISTIQUES STANDARD DES CHARGEURS OPTIMATE

🌐 Les chargeurs sont compatibles avec une tension d'alimentation de 100-240 V CA, 50-60 Hz. Les modèles à destination de différents continents sont adaptés avec la prise secteur CA adéquate.

Ⓢ Ils sont certifiés par la Commission californienne de l'énergie. Ils affichent une puissance de moins de 0,5 W (0,012 kWh par jour) sans raccordement à une batterie.

🇺🇸 Sécurité électrique et approbation EMC - Certification et conformité aux normes internationales par TÜV SÜD.

🔌 Les câbles de charge haut de gamme sont livrés avec chaque chargeur.

Connectiques

NOUVEAUTÉ

Oeillets adaptables !



Connecteur à demeure

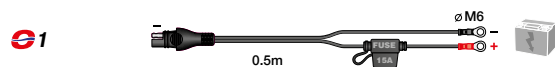

1 étanche

Réf. SAE71



12,40 € T.T.C.

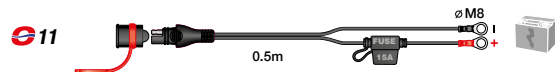

11 Étanche

Réf. SAE81



16,80 € T.T.C.

Connecteur DIN & allume cigare

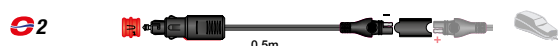

2 DIN et allume cigare*

Réf. SAE72

30,90 € T.T.C.

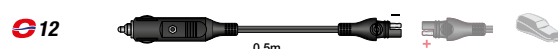

12 allume cigare M SAE*

Réf. SAE82

15,20 € T.T.C.



6 allume cigare F SAE*

Réf. SAE76

20,70 € T.T.C.

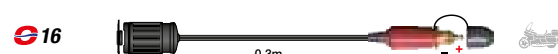

16 allume cigare F DIN M*

Réf. SAE86

26,30 € T.T.C.

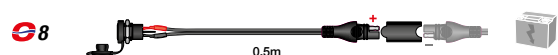

8 DIN F SAE + O1*

Réf. SAE78

30,40 € T.T.C.



18 Prise métal SAE*

Réf. SAE88

32,60 € T.T.C.

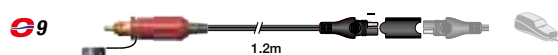

9 DIN mâle SAE*

Réf. SAE79

30,00 € T.T.C.

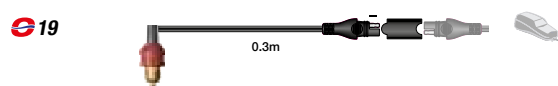

19 DIN mâle SAE*

Réf. SAE89

24,00 € T.T.C.

Rallonge / Pince

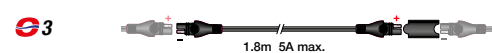

3 Rallonge SAE 1,8m 5A*

Réf. SAE73

16,80 € T.T.C.

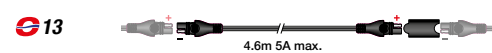

13 Rallonge SAE 4,6m 5A*

Réf. SAE83

27,60 € T.T.C.

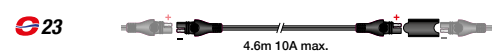

23 Rallonge SAE 4,6m 10A*

Réf. SAE93

30,90 € T.T.C.

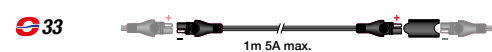

33 Rallonge SAE 1m 5A*

Réf. SAE103

13,90 € T.T.C.

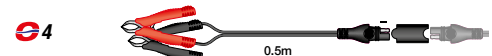

4 Pinces vers SAE*

Réf. SAE74

14,70 € T.T.C.

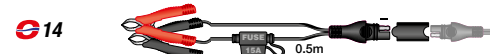

14 Pinces à fusible SAE*

Réf. SAE84

21,90 € T.T.C.

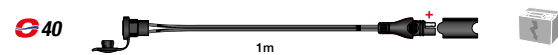

40 Rallonge étanche*

Réf. SAE110

19,60 € T.T.C.

* Eco-participation 0,42 € H.T. pour les chargeurs et 0,02 € H.T. pour la connectique.

Connectiques

Adaptateur / Séparateur

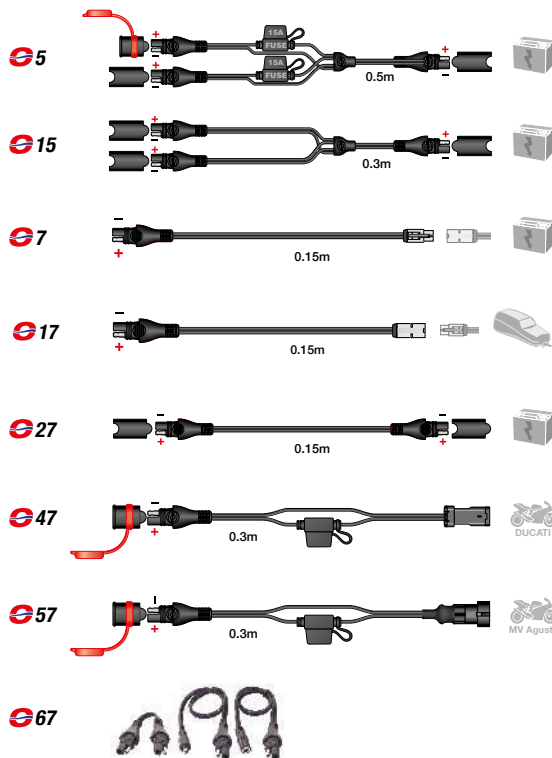

5 Séparateur Y fusibles SAE* **28,10 € T.T.C.**

Réf. SAE75

15 Séparateur Y SAE* **17,70 € T.T.C.**

Réf. SAE85

7 TM mâle vers SAE* **10,90 € T.T.C.**

Réf. SAE77

17 TM femelle vers SAE* **10,60 € T.T.C.**

Réf. SAE87

27 Inverseur de polarité* **10,90 € T.T.C.**

Réf. SAE97

47 Adaptateur Ducati* **46,60 € T.T.C.**

Réf. SAE47

57 Adaptateur MV Agusta* **27,20 € T.T.C.**

Réf. SAE57

67 Adaptateurs SAE DC* **23,20 € T.T.C.**

Réf. SAE137

Anciens connecteurs (avant 2012)

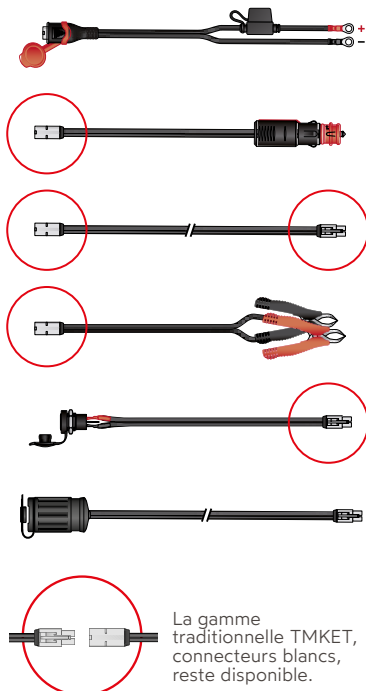

TM71 Faisceau accu* **12,20 € T.T.C.**

Réf. 630082MDL

TM72 allume cigare* **21,20 € T.T.C.**

Réf. 630081M

TM73 Rallonge 2,5m* **13,80 € T.T.C.**

Réf. AMEXTEND

TM74 Kit pinces* **12,20 € T.T.C.**

Réf. 630092M

TM78 DIN socket* **18,30 € T.T.C.**

Réf. 630091M

TM68 CIG socket* **14,50 € T.T.C.**

Réf. TM68

La gamme traditionnelle TMKET, connecteurs blancs, reste disponible.

Power accessoires**e 100****e100** Chargeur USB SAE***31,30 € T.T.C.**

Réf. T100*

**e 120****e120** Lampe LED SAE***28,40 € T.T.C.**

Réf. T120

**e 121****e121** Lampe LED KET***21,80 € T.T.C.**

Réf. T121*

**e 122****e122** Avert. de charge MF/AGM**17,30 € T.T.C.**

Réf. T122

**e 108****e108** Chargeur USB SAE rallonges***52,10 € T.T.C.**

Réf. T108KIT

**e 113****e113** Câbles USB 8PIN x2***13,10 € T.T.C.**

Réf. T113

**e 128****e128** Moniteur de charge Batterie***34,80 € T.T.C.**

Réf. T128*

**e 125****e125** Optimate Monitor**21,30 € T.T.C.**

Réf. T125

**e 105****e105** Chargeur USB 2 x 3,3mA**39,60 € T.T.C.**

Réf. T105

**e 115****e115** Chargeur USB 2 x 3,3mA**33,40 € T.T.C.**

Réf. T115

**e 106****e106** Chargeur USB 2 x 3,3mA**36,00 € T.T.C.**

Réf. T106

**e** Crochet pour chargeur**7,70 € T.T.C.**

Réf. TS252

BOUGIES



Bougies standard

Référence	€H.T.	€T.T.C.
AB6	9,00 €	10,80 €
B10EG	9,75 €	11,70 €
B10ES	5,08 €	6,10 €
B10HS	4,83 €	5,80 €
B2LM	3,08 €	3,70 €
B4	4,42 €	5,30 €
B4LM	3,08 €	3,70 €
B5ES	4,96 €	5,95 €
B5HS	4,29 €	5,15 €
B6ES	4,33 €	5,20 €
B6HS	4,33 €	5,20 €
B6HS10	4,42 €	5,30 €
B6HVX	13,92 €	16,70 €
B6L	4,46 €	5,35 €
B6S	4,46 €	5,35 €
B7ES	4,54 €	5,45 €
B7HS	4,38 €	5,25 €
B7HS10	4,50 €	5,40 €
B7HVX	13,92 €	16,70 €
B7S	4,54 €	5,45 €
B8EFS	5,54 €	6,65 €
B8EG	9,96 €	11,95 €
B8ES	3,92 €	4,70 €
B8HCS	9,83 €	11,80 €
B8HS	4,33 €	5,20 €
B9EFS	4,83 €	5,80 €
B9EG	9,88 €	11,85 €

Référence	€H.T.	€T.T.C.
B9ES	4,46 €	5,35 €
B9HCS	9,75 €	11,70 €
B9HS	4,08 €	4,90 €
B9HS10	4,42 €	5,30 €
BCP7ES	4,63 €	5,55 €
BCPR5ES	5,00 €	6,00 €
BCPR6E	5,75 €	6,90 €
BCPR6ES	5,08 €	6,10 €
BCPR6ET	9,79 €	11,75 €
BCPR7EIX	24,58 €	29,50 €
BCPR7ES11	5,96 €	7,15 €
BCPR7ET	9,79 €	11,75 €
BCR8ES	6,13 €	7,35 €
BKR5E	5,13 €	6,15 €
BKR5E11	4,83 €	5,80 €
BKR5EIX	22,25 €	26,70 €
BKR5EK	7,88 €	9,45 €
BKR5ES	5,00 €	6,00 €
BKR5ES11	5,29 €	6,35 €
BKR5EYA	5,58 €	6,70 €
BKR5EZ	4,96 €	5,95 €
BKR6E	5,08 €	6,10 €
BKR6E11	4,88 €	5,85 €
BKR6EIX	24,92 €	29,90 €
BKR6EIX11	22,42 €	26,90 €
BKR6EK	8,75 €	10,50 €
BKR6EKC	10,42 €	12,50 €

Référence	€H.T.	€T.T.C.
BKR6EKUB	16,75 €	20,10 €
BKR6EQUP	18,04 €	21,65 €
BKR6EVX	21,92 €	26,30 €
BKR6EYA11	5,83 €	7,00 €
BKR6EZ	5,17 €	6,20 €
BKR7E	5,58 €	6,70 €
BKR7E11	5,54 €	6,65 €
BKR7EIX	25,29 €	30,35 €
BKR7EIX11	22,25 €	26,70 €
BKR7EKC	11,50 €	13,80 €
BKR7EKCEN	9,75 €	11,70 €
BKR7EKU	12,75 €	15,30 €
BKR7EQUP	47,88 €	57,45 €
BKR8E11	6,17 €	7,40 €
BKR8EIX	23,50 €	28,20 €
BKUR6EK	8,88 €	10,65 €
BKUR7ET	10,92 €	13,10 €
BM6A	3,42 €	4,10 €
BM6F	4,04 €	4,85 €
BM7A	3,58 €	4,30 €
BMR4A	5,33 €	6,40 €
BMR6A	4,58 €	5,50 €
BMR7A	4,46 €	5,35 €
BP4ES	4,50 €	5,40 €
BP4FS	5,17 €	6,20 €
BP4HA	4,79 €	5,75 €
BP4HS	4,96 €	5,95 €

Référence	€H.T.	€T.T.C.
BP5ES	4,04 €	4,85 €
BP5HS	4,54 €	5,45 €
BP6EFS	4,42 €	5,30 €
BP6ES	4,13 €	4,95 €
BP6ES11	5,92 €	7,10 €
BP6HS	4,50 €	5,40 €
BP6HSA	4,96 €	5,95 €
BP6S	4,67 €	5,60 €
BP7ES	3,92 €	4,70 €
BP7ES11	5,79 €	6,95 €
BP7HS	4,71 €	5,65 €
BP7HS10	4,42 €	5,30 €
BP8ES	5,21 €	6,25 €
BP8HN10	4,58 €	5,50 €
BP8HS	4,96 €	5,95 €
BP8HSA	4,50 €	5,40 €
BP8HVX	12,92 €	15,50 €
BPM6A	3,79 €	4,55 €
BPM6A10	4,38 €	5,25 €
BPM7A	3,63 €	4,35 €
BPM7Y	4,50 €	5,40 €
BPMR6A	4,79 €	5,75 €
BPMR7A	4,13 €	4,95 €
BPMR8Y	5,67 €	6,80 €
BPR10EVX	22,00 €	26,40 €
BPR4HS	5,96 €	7,15 €
BPR4HS10	5,79 €	6,95 €



Référence	€H.T.	€T.T.C.	Référence	€H.T.	€T.T.C.	Référence	€H.T.	€T.T.C.	Référence	€H.T.	€T.T.C.
BPR5EIX	24,50 €	29,40 €	BR8HSA	5,88 €	7,05 €	CR6EH9	16,42 €	19,70 €	DCPR6E	11,33 €	13,60 €
BPR5ES	4,88 €	5,85 €	BR9ECM	12,25 €	14,70 €	CR6HIX	22,38 €	26,85 €	DCPR7E	8,54 €	10,25 €
BPR5ES11	5,33 €	6,40 €	BR9ECMIX	22,38 €	26,85 €	CR6HS	5,96 €	7,15 €	DCPR7EA9	13,38 €	16,05 €
BPR5EVX	21,92 €	26,30 €	BR9ECS	11,50 €	13,80 €	CR6HSA	6,00 €	7,20 €	DCPR7EIX	23,29 €	27,95 €
BPR5HS	5,79 €	6,95 €	BR9EG	12,21 €	14,65 €	CR6HSB	4,75 €	5,70 €	DCPR7EN10	11,71 €	14,05 €
BPR6EFS	4,96 €	5,95 €	BR9EGN8	11,67 €	14,00 €	CR6HSB9	5,08 €	6,10 €	DCPR7EVX	21,42 €	25,70 €
BPR6EIX	23,33 €	28,00 €	BR9EIX	21,96 €	26,35 €	CR7E	11,75 €	14,10 €	DCPR8E	9,88 €	11,85 €
BPR6ES	5,04 €	6,05 €	BR9ES	5,63 €	6,75 €	CR7EB	11,38 €	13,65 €	DCPR8EIX	24,42 €	29,30 €
BPR6ES11	5,33 €	6,40 €	BR9EYA	5,79 €	6,95 €	CR7EH9	15,67 €	18,80 €	DCPR8EKC	12,79 €	15,35 €
BPR6HS	5,21 €	6,25 €	BR9HIX	22,38 €	26,85 €	CR7EIX	22,79 €	27,35 €	DCPR8EN	12,88 €	15,45 €
BPR6HSA	5,96 €	7,15 €	BR9HS	6,13 €	7,35 €	CR7EK	16,79 €	20,15 €	DCPR9E	11,88 €	14,25 €
BPR7EIX	24,38 €	29,25 €	BR9HS10	5,29 €	6,35 €	CR7EKA	15,63 €	18,75 €	DCPR9EIX	26,83 €	32,20 €
BPR7ES	4,96 €	5,95 €	BUHW	7,00 €	8,40 €	CR7EKB	16,21 €	19,45 €	DCR7EIX	22,38 €	26,85 €
BPR7HIX	23,42 €	28,10 €	BURGET	7,75 €	9,30 €	CR7HIX	22,38 €	26,85 €	DCR8EIX	23,42 €	28,10 €
BPR7HS	5,79 €	6,95 €	BUR7EQ	37,46 €	44,95 €	CR7HS	5,54 €	6,65 €	DCR9EIX	22,38 €	26,85 €
BPR8EIX	22,38 €	26,85 €	BUZHW2	21,71 €	26,05 €	CR7HSA	5,71 €	6,85 €	DIMR8C10	35,21 €	42,25 €
BPR8ES	5,63 €	6,75 €	C5HSA	4,79 €	5,75 €	CR8E	11,54 €	13,85 €	DP6EA9	4,88 €	5,85 €
BPR8HIX	22,38 €	26,85 €	C6HSA	4,96 €	5,95 €	CR8EB	11,33 €	13,60 €	DP7EA9	4,79 €	5,75 €
BPR8HS	6,13 €	7,35 €	C7E	9,75 €	11,70 €	CR8EH9	15,58 €	18,70 €	DP8EA9	4,96 €	5,95 €
BPR9EIX	22,54 €	27,05 €	C7HSA	4,88 €	5,85 €	CR8EH9S	15,38 €	18,45 €	DP8EVX9	12,13 €	14,55 €
BPR9ES	5,63 €	6,75 €	C8E	9,75 €	11,70 €	CR8EHIX9	21,92 €	26,30 €	DP9EA9	4,96 €	5,95 €
BR10ECM	11,75 €	14,10 €	C8HSA	4,96 €	5,95 €	CR8EIA10	23,21 €	27,85 €	DPR5EA9	5,96 €	7,15 €
BR10ECMIX	22,83 €	27,40 €	C9E	9,75 €	11,70 €	CR8EIA9	22,17 €	26,60 €	DPR6EA9	5,88 €	7,05 €
BR10ECS	11,54 €	13,85 €	C9EH9	11,17 €	13,40 €	CR8EIB10	25,13 €	30,15 €	DPR6EB9	5,29 €	6,35 €
BR10EG	12,58 €	15,10 €	CMR5H	7,88 €	9,45 €	CR8EIX	21,96 €	26,35 €	DPR7EA9	5,54 €	6,65 €
BR10EIX	22,38 €	26,85 €	CMR6A	8,08 €	9,70 €	CR8EK	15,50 €	18,60 €	DPR7EIX9	22,75 €	27,30 €
BR10ES	6,88 €	8,25 €	CMR6H	7,04 €	8,45 €	CR8EKB	16,25 €	19,50 €	DPR8EA9	5,54 €	6,65 €
BR10HIX	22,83 €	27,40 €	CMR7A	8,13 €	9,75 €	CR8EVX	18,71 €	22,45 €	DPR8EIX9	23,38 €	28,05 €
BR2LM	3,13 €	3,75 €	CMR7H	7,67 €	9,20 €	CR8HIX	22,38 €	26,85 €	DPR8Z	11,75 €	14,10 €
BR4HS	5,67 €	6,80 €	CPR6EA9	11,50 €	13,80 €	CR8HS	5,17 €	6,20 €	DPR9EA9	5,63 €	6,75 €
BR4LM	5,25 €	6,30 €	CPR6EA9S	11,67 €	14,00 €	CR8HSA	6,13 €	7,35 €	DPR9EIX9	22,00 €	26,40 €
BR6ES	6,13 €	7,35 €	CPR7EA9	11,33 €	13,60 €	CR8HVX	18,00 €	21,60 €	DPR9Z	11,54 €	13,85 €
BR6HIX	23,42 €	28,10 €	CPR7EAIX9	23,79 €	28,55 €	CR9E	11,58 €	13,90 €	DR6HS	5,96 €	7,15 €
BR6HS	6,00 €	7,20 €	CPR8E	11,50 €	13,80 €	CR9EB	11,75 €	14,10 €	DR7EA	5,79 €	6,95 €
BR6HSA	5,96 €	7,15 €	CPR8EA9	15,38 €	18,45 €	CR9EH9	16,21 €	19,45 €	DR7EIX	23,42 €	28,10 €
BR7EIX	22,38 €	26,85 €	CPR8EAIX9	23,21 €	27,85 €	CR9EHI9	29,79 €	35,75 €	DR7ES	5,96 €	7,15 €
BR7ES	5,88 €	7,05 €	CPR8EB9	11,67 €	14,00 €	CR9EHIX9	21,96 €	26,35 €	DR8EA	5,63 €	6,75 €
BR7HIX	22,38 €	26,85 €	CPR9EA9	11,88 €	14,25 €	CR9EIA9	22,13 €	26,55 €	DR8EB	11,21 €	13,45 €
BR7HS	5,33 €	6,40 €	CPR9EB9	11,21 €	13,45 €	CR9EIB9	30,21 €	36,25 €	DR8EIX	21,96 €	26,35 €
BR7HS10	5,29 €	6,35 €	CR10E	11,63 €	13,95 €	CR9EIX	21,96 €	26,35 €	DR8ES	5,54 €	6,65 €
BR7HS100M	5,29 €	6,35 €	CR10EH9	15,17 €	18,20 €	CR9EK	15,63 €	18,75 €	DR8ESL	5,54 €	6,65 €
BR8ECM	12,25 €	14,70 €	CR10EIX	22,96 €	27,55 €	CR9EKB	17,08 €	20,50 €	DR8HS	6,13 €	7,35 €
BR8ECMIX	22,38 €	26,85 €	CR10EK	15,33 €	18,40 €	CR9EKPA	31,21 €	37,45 €	DR9EA	5,54 €	6,65 €
BR8EG	11,71 €	14,05 €	CR4HSB	5,54 €	6,65 €	D10EA	4,96 €	5,95 €	DR9EIX	22,50 €	27,00 €
BR8EIX	22,29 €	26,75 €	CR5EH9	15,92 €	19,10 €	D6EA	4,79 €	5,75 €	ER8EH	29,21 €	35,05 €
BR8ES	5,29 €	6,35 €	CR5HIX	22,54 €	27,05 €	D6HA	4,79 €	5,75 €	ER8EHIX	30,46 €	36,55 €
BR8ES11	5,29 €	6,35 €	CR5HS	5,58 €	6,70 €	D7EA	4,96 €	5,95 €	ER8EHN	29,33 €	35,20 €
BR8HIX	22,96 €	27,55 €	CR5HSA	6,13 €	7,35 €	D8EA	4,88 €	5,85 €	ER9EH	29,21 €	35,05 €
BR8HS	5,33 €	6,40 €	CR5HSB	5,63 €	6,75 €	D8HA	4,96 €	5,95 €	ER9EH6N	30,38 €	36,45 €
BR8HS10	5,25 €	6,30 €	CR6E	11,50 €	13,80 €	D9EA	4,96 €	5,95 €	ER9EHIX	28,96 €	34,75 €

Bougies standard

Référence	€H.T.	€T.T.C.
FR9B11	29,79 €	35,75 €
GR7CI8	20,04 €	24,05 €
IFR5L11	41,71 €	50,05 €
IFR6G11K	33,25 €	39,90 €
IFR8H11	36,25 €	43,50 €
IFR9H11	35,42 €	42,50 €
IJR8B9	45,00 €	54,00 €
IKR9J8	19,29 €	23,15 €
ILFR6GE	29,25 €	35,10 €
ILKAR7A7	15,88 €	19,05 €
ILKR9G8	21,50 €	25,80 €
ILZKAR7B11	36,21 €	43,45 €
IMR8C9H	36,25 €	43,50 €
IMR8C9HES	39,50 €	47,40 €
IMR8E9HES	42,58 €	51,10 €
IMR9A9H	36,83 €	44,20 €
IMR9B9H	39,13 €	46,95 €
IMR9C9H	38,79 €	46,55 €
IMR9C9HES	36,75 €	44,10 €
IMR9D9H	36,96 €	44,35 €
IMR9E9HES	35,92 €	43,10 €
IZFR6F11	33,71 €	40,45 €
J1	9,25 €	11,10 €
J9A	9,67 €	11,60 €
JR10B	9,83 €	11,80 €
JR8B	10,08 €	12,10 €
JR9B	9,67 €	11,60 €
JR9C	11,75 €	14,10 €
KR8DI	28,88 €	34,65 €
KR9CI	22,54 €	27,05 €
LFR5A11	7,96 €	9,55 €
LFR5AP11	24,58 €	29,50 €
LFR6A11	9,13 €	10,95 €
LKAR8A9	26,67 €	32,00 €
LKAR8A19	32,25 €	38,70 €
LKAR8B19	33,75 €	40,50 €
LKAR9B19	32,58 €	39,10 €
LKR7E	9,17 €	11,00 €
LMAR6A9	19,50 €	23,40 €
LMAR7A9	26,83 €	32,20 €
LMAR7D10	20,63 €	24,75 €
LMAR8A9	28,21 €	33,85 €
LMAR8A9S	28,46 €	34,15 €
LMAR8A10	16,92 €	20,30 €
LMAR8A18	18,17 €	21,80 €
LMAR8B19	35,17 €	42,20 €

Référence	€H.T.	€T.T.C.
LMAR8C9	26,71 €	32,05 €
LMAR8DJ	19,79 €	23,75 €
LMAR8E17	13,00 €	15,60 €
LMAR8F9	17,29 €	20,75 €
LMAR8G	14,67 €	17,60 €
LMAR8J9E	11,25 €	13,50 €
LMAR9A10	29,46 €	35,35 €
LMAR9A18	35,13 €	42,15 €
LMAR9DJ	16,54 €	19,85 €
LMAR9EJ	27,96 €	33,55 €
LMAR9F10G	31,50 €	37,80 €
LMAR9G	25,79 €	30,95 €
LMDR10AJS	21,58 €	25,90 €
LR8A	12,17 €	14,60 €
LR8B	13,42 €	16,10 €
LZKAR7A	8,04 €	9,65 €
MAR10AJ	28,96 €	34,75 €
MAR8BJDS	19,13 €	22,95 €
MAR9AJ	27,08 €	32,50 €
MR7B18	40,17 €	48,20 €
MR7F	13,08 €	15,70 €
MR8B18	23,96 €	28,75 €
MR8E9	12,67 €	15,20 €
MR9F	10,83 €	13,00 €
PFR7B11	26,54 €	31,85 €
PFR7G9	15,17 €	18,20 €
PFR7S8EG	20,29 €	24,35 €
PMR7A	41,50 €	49,80 €
PMR8B	32,67 €	39,20 €
PMR9B	30,50 €	36,60 €
PTR5A13	14,75 €	17,70 €
PTR5D10	15,67 €	18,80 €
PZFR6H	30,50 €	36,60 €
PZFR7GG	30,92 €	37,10 €
SILMAR10A9S	38,75 €	46,50 €
SILMAR7A9S	34,29 €	41,15 €
SILMAR8A9S	24,96 €	29,95 €
SILMAR8C9	46,88 €	56,25 €
SILMAR9A9S	36,96 €	44,35 €
SILMAR9B9	52,67 €	63,20 €
SIMR8A9	37,54 €	45,05 €
ZFR4F11	9,21 €	11,05 €
ZFR7F11	8,08 €	9,70 €
ZGR5B	5,42 €	6,50 €
ZMR7AP	30,54 €	36,65 €

Bougies racing

Référence	€H.T.	€T.T.C.
B105EGP	40,79 €	48,95 €
B10EGP	40,79 €	48,95 €
B11EGP	37,29 €	44,75 €
B11EGV	15,67 €	18,80 €
B85EGV	15,67 €	18,80 €
B9EGP	21,92 €	26,30 €
R0045G11	36,54 €	43,85 €
R0045J9	37,29 €	44,75 €
R0045Q10	168,96 €	202,75 €
R0045Q11	122,46 €	146,95 €
R01711	20,25 €	24,30 €
R0178	20,25 €	24,30 €
R0179	20,25 €	24,30 €
R0373A10	76,38 €	91,65 €
R0373A9	76,38 €	91,65 €
R0409B8	78,88 €	94,65 €
R0409B9	58,13 €	69,75 €
R0451B8	58,17 €	69,80 €
R0451C10	199,63 €	239,55 €
R0465B10	185,79 €	222,95 €
R21710	21,38 €	25,65 €
R2179	21,38 €	25,65 €
R234910	100,88 €	121,05 €
R23499	135,29 €	162,35 €
R252510	56,42 €	67,70 €
R25259	54,58 €	65,50 €

Référence	€H.T.	€T.T.C.
R518410	53,83 €	64,60 €
R5184105	51,46 €	61,75 €
R5300A10	61,21 €	73,45 €
R5300A95	51,46 €	61,75 €
R54007	21,92 €	26,30 €
R5540F105	59,25 €	71,10 €
R6252E105	10,88 €	13,05 €
R6252K105	10,71 €	12,85 €
R6254E105	10,96 €	13,15 €
R6254K105	11,08 €	13,30 €
R660110	42,83 €	51,40 €
R66019	41,54 €	49,85 €
R669010	39,79 €	47,75 €
R669011	39,54 €	47,45 €
R671210	45,42 €	54,50 €
R6918B8	72,17 €	86,60 €
R728210	75,21 €	90,25 €
R7282105	75,96 €	91,15 €
R728211	76,58 €	91,90 €
R7282A105	127,42 €	152,90 €
R737610	73,71 €	88,45 €
R73769	75,21 €	90,25 €
R7429A10	103,29 €	123,95 €
R74369	71,92 €	86,30 €
R74389	95,42 €	114,50 €



Capuchons

Référence	€H.T.	€T.T.C.
LO5EA	10,75 €	12,90 €
LB05E	5,75 €	6,90 €
LB05EH	5,92 €	7,10 €
LB05EHF	5,63 €	6,75 €
LB05EMH	15,33 €	18,40 €
LB05EMHR	15,33 €	18,40 €
LB05EP	6,04 €	7,25 €
LB05EPK	7,67 €	9,20 €
LB05ER	5,38 €	6,45 €
LB05EZ	7,67 €	9,20 €
LB05F	5,96 €	7,15 €
LB05FG	9,75 €	11,70 €
LB10E	5,71 €	6,85 €
LB10EH	5,71 €	6,85 €
LB10EHAH	7,50 €	9,00 €
LB10EHF	5,38 €	6,45 €
LB10F	5,71 €	6,85 €
LBE	6,04 €	7,25 €
LBER	16,33 €	19,60 €

Référence	€H.T.	€T.T.C.
LBF	6,04 €	7,25 €
LD05E	7,04 €	8,45 €
LD05FP	7,58 €	9,10 €
LD05FR	5,46 €	6,55 €
LD10F	5,71 €	6,85 €
LZ05F	10,08 €	12,10 €
LZFH	2,29 €	2,75 €
SB01F	6,42 €	7,70 €
SB05E	6,25 €	7,50 €
SB05F	6,33 €	7,60 €
SB05FP	8,96 €	10,75 €
SB10E	6,75 €	8,10 €
SB10F	6,17 €	7,40 €
SD01F	6,42 €	7,70 €
SD05E	6,96 €	8,35 €
SD05EG	12,67 €	15,20 €
SD05FM	15,33 €	18,40 €
SD05FMC	15,71 €	18,85 €
SD05FP	9,42 €	11,30 €

Référence	€H.T.	€T.T.C.
SD05FR	5,88 €	7,05 €
SD10F	6,17 €	7,40 €
TB05EMA	17,08 €	20,50 €
TB05EMR	16,58 €	19,90 €
TB10EMY	15,58 €	18,70 €
TRS1225B	112,58 €	135,10 €
TRS1233AR	93,79 €	112,55 €
TRS1408F	77,46 €	92,95 €
VO5E	12,42 €	14,90 €
VB05E	7,58 €	9,10 €
VB05F	7,79 €	9,35 €
VB05FP	10,00 €	12,00 €
VB05FR	7,17 €	8,60 €
VB10F	7,58 €	9,10 €
VD01F	7,92 €	9,50 €
VD05EG	12,92 €	15,50 €
VD05EM	16,79 €	20,15 €
VD05EMH	14,25 €	17,10 €
VD05F	7,21 €	8,65 €

Référence	€H.T.	€T.T.C.
VD05FMH	16,13 €	19,35 €
VD05FML	17,25 €	20,70 €
VD10F	7,58 €	9,10 €
XB01F	8,00 €	9,60 €
XB05F	7,04 €	8,45 €
XB05FP	12,13 €	14,55 €
XB05FR	7,21 €	8,65 €
XB10F	7,58 €	9,10 €
XD01F	8,21 €	9,85 €
XD05F	6,67 €	8,00 €
XD05FP	16,21 €	19,45 €
XD05FR	7,21 €	8,65 €
XD10F	7,58 €	9,10 €
XZ01F	12,54 €	15,05 €
YB05F	7,58 €	9,10 €
YB10F	7,58 €	9,10 €
YD05F	9,50 €	11,40 €

Câbles racing

Référence	H.T.	T.T.C.
CR1	28,04 €	33,65 €
CR2	29,04 €	34,85 €
CR3	33,04 €	39,65 €
CR4	29,04 €	34,85 €
CR5	26,04 €	31,25 €
CR6	25,17 €	30,2 €

Gaine et capuchon moulés en silicone

Antiparasites avec câbles

Référence	H.T.	T.T.C.
LY11	13,25 €	15,9 €
SY11	12,79 €	15,35 €
XY11	18,54 €	22,25 €

Câbles avec antiparasite en résine phénolique



AMPOULES

Kit LED R3000

Plus de visibilité

Tous les composants électriques et électroniques sont intégrés dans une seule fonte d'aluminium pour minimiser le poids, le volume et éviter les ruptures désagréables.

Grâce à cette conception unique, la luminosité est puissante, la lampe est légère, fiable et simple à installer.

Le kit comprend des adaptateurs de montage sur feux conçus pour des Ampoules de types H1, H2, H3, H4, H7, KTM d'origine et Sherco.

Utilisation sur circuit uniquement.

32W - 12 V - 3A - 120/160 kHz

3000/2200 lumen - Blanc pur 6000 K - IP68



LED R3000 R-Tech - RLEDRTECH016

59,95 € HT

Luminosité +300%

Homologation : CE - ROHS - DOT



6000K

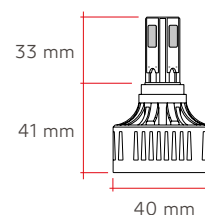

Installation sans outils

Grâce aux adaptateurs, le remplacement de la lampe halogène d'origine est simple et rapide.



1 Retirer la lampe



2 Insérer l'adaptateur

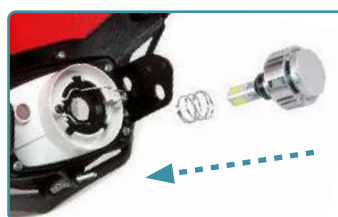

3 Insérer le ressort et la led



4 Tourner jusqu'au blocage.

Gamme PHILIPS

Vision	CityVision	X-tremeVision	CrystalVision
Performance du faisceau 	Performance du faisceau 	Performance du faisceau 	Performance du faisceau
Couleur de lumière 2800 K 3400 K 4000 K 	Couleur de lumière 2800 K 3400 K 4000 K 	Couleur de lumière 2800 K 3400 K 4000 K 	Couleur de lumière 2800 K 3400 K 4000 K
Durée de vie 0 h 400 h >800 h 	Durée de vie 0 h 400 h >800 h 	Durée de vie 0 h 400 h >800 h 	Durée de vie 0 h 400 h >800 h

H4 / H7 / HS1

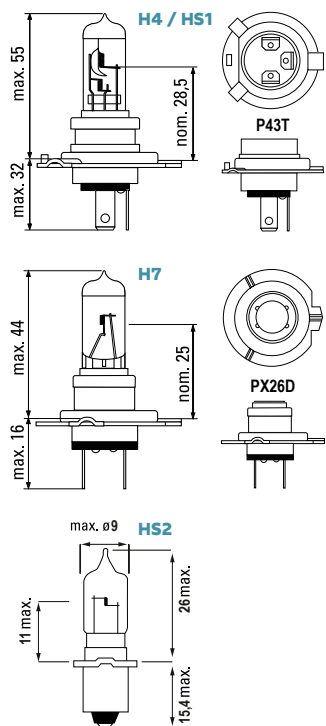

Marque	Désignation	V	W	Référence	€ H.T.	€ T.T.C.
PHILIPS	H4 X-Treme Vision Moto - P43T	12	60/55	20123426	22,75 €	27,30 €
PHILIPS	H4 City Vision Moto - P43T	12	60/55	20123424	14,00 €	16,80 €
PHILIPS	H4 CrystalVision Moto - P43T	12	60/55	20123421	20,42 €	24,50 €
PHILIPS	H4 Vision Moto - P43T	12	60/55	20123422	7,83 €	9,40 €
HERT	H4 - P43T	12	60/55	208045	5,99 €	7,19 €
HERT	H4 Blue - P43T	12	60/55	2080454	14,04 €	16,85 €
PHILIPS	H7 X-Treme Vision Moto - PX26D	12	55	20129726	32,42 €	38,90 €
PHILIPS NEW	H7 Crystalvision Moto	12	55	20129721	31,29 €	37,55 €
PHILIPS	H7 City Vision Moto - PX26D	12	55	20129724	20,33 €	24,40 €
PHILIPS	H7 Vision Moto - PX26D	12	55	20129722	11,67 €	14,00 €
HERT	H7 - PX26D	12	55	209045	9,14 €	10,97 €
PHILIPS	HS1 City Vision Moto - PX43T	12	35/35	20126364	27,13 €	32,55 €
PHILIPS	HS1 Vision Moto - PX43T	12	35/35	20126362	12,75 €	15,30 €
HERT	HS1 - PX43T	12	35/35	201670	9,74 €	11,69 €

H1

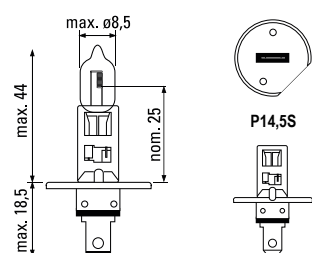

Marque	Désignation	V	W	Référence	€ H.T.	€ T.T.C.
PHILIPS	H1 Vision Moto - P14,5S	12	55	20122582	6,46 €	7,75 €
HERT	H1 - P14,5S	12	55	201655	5,33 €	6,40 €
HERT	H1 Bleu - P14,5S	12	55	2075454	10,85 €	13,02 €

H3

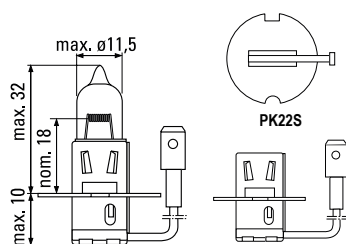

Marque	Désignation	V	W	Référence	€ H.T.	€ T.T.C.
PHILIPS	H3 Vision Moto - PK22S	12	55	2012336	7,38 €	8,85 €
HERT	H3 - PK22S	12	55	201658	9,30 €	11,16 €
HERT	H3 Bleu - PK22S	12	55	2079454	9,91 €	11,89 €

H8 / H9 / H11 / HB3 / HB4

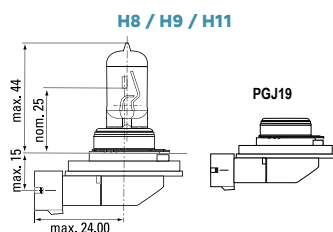

Marque	Désignation	V	W	Référence	€ H.T.	€ T.T.C.
HERT	H8 - PGJ19	12	35	209543	19,43 €	23,32 €
HERT	H9 - PGJ19-5	12	65	209646	19,77 €	23,72 €
HERT	H11 - PGJ19-2	12	55	209845	20,18 €	24,22 €

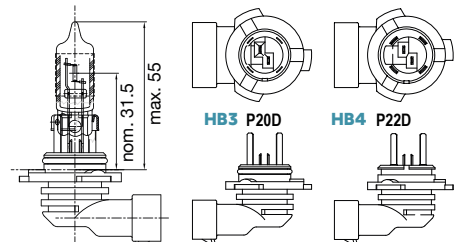

Marque	Désignation	V	W	Référence	€ H.T.	€ T.T.C.
PHILIPS	HB3 Vision Moto - P20D	12	60	2009005	18,71 €	22,45 €
PHILIPS	HB4 Vision Moto - P22D	12	55	2009006	18,71 €	22,45 €

R2

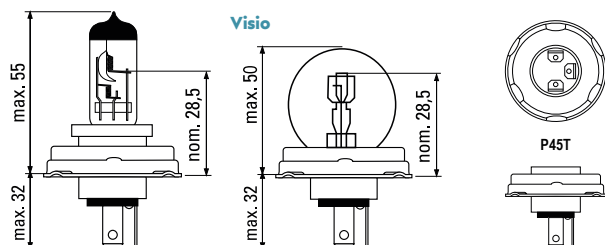

Marque	Désignation	V	W	Référence	€ H.T.	€ T.T.C.
PHILIPS	R2 Visio - P45T	12	45/40	2012475	9,08 €	10,90 €
PHILIPS	R2 - P45T	12	45/40	2012620	5,00 €	6,00 €
HERT	R2 - P45T	12	45/40	200501	6,52 €	7,82 €
HERT	R2 - P45T	12	60/55	201661	12,11 €	14,53 €

BA20D / P26S

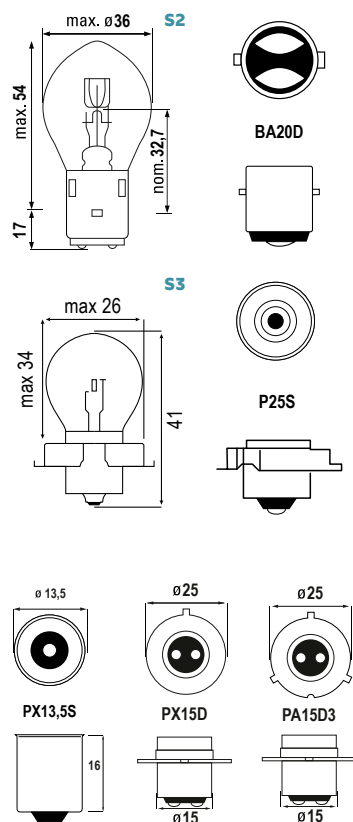

Marque	Désignation	V	W	Référence	€ H.T.	€ T.T.C.
PHILIPS	S2 standard - BA20D	12	35/35	2012728	5,38 €	6,45 €
HERT	BA20D	6	15/15	200518	4,13 €	4,96 €
HERT	BA20D	6	25/25	200520	4,49 €	5,39 €
HERT	BA20D	6	30/35	200521	5,23 €	6,28 €
HERT	BA20D	6	45/40	200527	4,08 €	4,90 €
HERT	BA20D (R110)	12	25/25	200529	4,58 €	5,50 €
HERT	BA20D	12	35/35	200523	4,35 €	5,22 €
HERT	BA20D Bleu	12	35/35	200525	6,44 €	7,73 €
HERT	BA20D	12	45/40	200528	4,51 €	5,41 €
HERT	BA20D HALOGENE	12	35/35	203980	18,96 €	22,75 €
HERT	BA20D HALOGENE	12	35/35	201685	8,31 €	9,97 €
HERT	BA20D SEMI-HALOGENE	12	45/40	201687	8,30 €	9,97 €
PHILIPS	S3 - P26S	12	15	2012008	4,33 €	5,20 €
HERT	P26S R507	6	20	200400	3,14 €	3,77 €
HERT	P26S	6	15	200401	2,76 €	3,31 €
HERT	P26S	12	25	200405	2,76 €	3,31 €
HERT	P26S	12	15	200410	2,36 €	2,83 €
HERT	P26S	12	20	200425	2,48 €	2,98 €
HERT	P26S HALOGENE	12	15	201676	10,24 €	12,29 €
HERT	HALOGENE PX13,5S	12	20	201678	10,24 €	12,29 €
HERT	KRIPTON PX15D	12	18/18	201804	3,66 €	4,39 €
HERT	KRIPTON PX15D	12	35/35	201801	14,69 €	17,63 €
HERT	KRIPTON PA15D3	12	35/35	201800	13,97 €	16,76 €



STOP, Clignotants et témoins

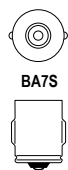

BA7S

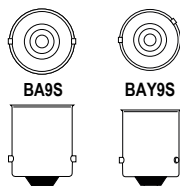

BA9S

BAY9S

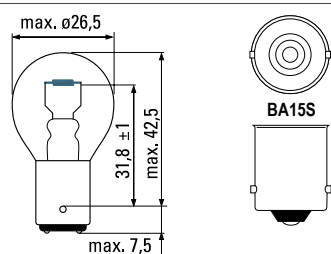

BA15S

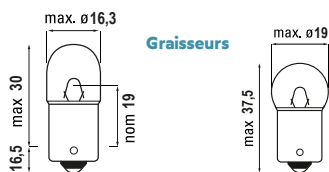

Graisseurs

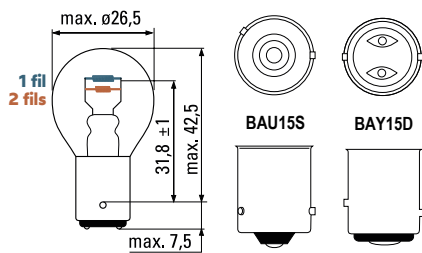

BAU15S

BAY15D

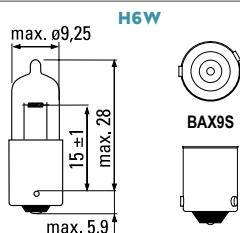

H6W

BAX9S

Marque	Désignation	V	W	Référence	€ H.T.	€ T.T.C.
HERT	Micro BA7S	12	2	201107	1,11 €	1,33 €
HERT	Micro BA9S	6	4	200120	1,11 €	1,33 €
HERT	Micro BA9S	6	5	201135	1,21 €	1,45 €
HERT	Micro BA9S	12	3	200112	0,95 €	1,14 €
HERT	Micro BA9S	12	4	200121	1,11 €	1,33 €
HERT	Micro BA9S	12	5	201125	1,11 €	1,33 €
HERT	Halogène BA9S	12	10	201126	5,30 €	6,36 €
HERT	Micro BA9S	12	23	201127	3,82 €	4,58 €
HERT	Micro BAY9S orange	12	21	201131	5,32 €	6,38 €
HERT	Halogène BAY9S orange	12	10	201132	4,28 €	5,14 €
HERT	Halogène BAY9S orange	12	10	201133	5,31 €	6,37 €
HERT	Semi halogène BAY9S orange	12	21	201130	5,32 €	6,38 €
HERT	Micro BAY9S orange	12	23	201128	3,42 €	4,10 €
PHILIPS	R5W - BA15S	12	5	2012821	1,08 €	1,30 €
PHILIPS	R10W - BA15S	12	10	2012814	1,08 €	1,30 €
PHILIPS	P21W - BA15S	12	21	2012498	1,38 €	1,65 €
HERT	1 FIL - BA15S	12	5	200351	1,19 €	1,43 €
HERT	1 FIL - BA15S	12	10	200341	1,39 €	1,67 €
HERT	1 FIL - BA15S	12	21	200381	1,00 €	1,20 €
HERT	GRAISSEUR - BA15S	6	5	200302	1,12 €	1,34 €
HERT	GRAISSEUR - BA15S	6	10	200305	1,53 €	1,84 €
HERT	GRAISSEUR - BA15S	12	5	200304	1,12 €	1,34 €
HERT	GRAISSEUR - BA15S	12	10	200306	0,82 €	0,98 €
HERT	GRAISSEUR - BA15S Orange	12	10	200307	1,67 €	2,00 €
HERT	1 FIL - BA15S Orange	12	21	201250	2,22 €	2,66 €
PHILIPS	PY21W Ambre - BAU15S	12	21	2012496	2,46 €	2,95 €
FLOSSER	1 FIL - BAU15S Orange	12	10	200308	2,15 €	2,58 €
HERT	1 FIL - BAU15S Orange	12	10	202501	5,04 €	6,05 €
HERT	1 FIL - BAU15S Orange	12	21	201249	2,27 €	2,72 €
PHILIPS	P21/5W - BAY15D	12	21/5	2012499	1,96 €	2,35 €
HERT	2 FILS - BAY15D	6	15/3	203330	1,59 €	1,91 €
HERT	2 FILS - BAY15D	6	21/5	203380	1,58 €	1,90 €
HERT	2 FILS - BAY15D	12	21/5	203381	1,21 €	1,45 €
PHILIPS	H6W BAX9S	12	6	2012036	7,83 €	9,40 €

T5 Tableau de bord

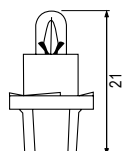

Marque	Désignation	V	W	Référence	€ H.T.	€ T.T.C.
HERT	T5 tableau de bord	12	1,2	201900	2,88 €	3,46 €
HERT	T5 tableau de bord	12	2	201902	2,84 €	3,41 €

Navettes

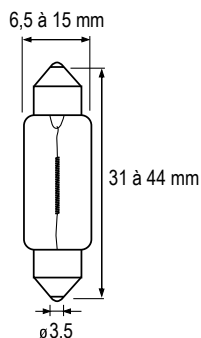

Marque	Désignation	V	W	Référence	€ H.T.	€ T.T.C.
HERT	NAVETTE 6,5 x 31	6	0,6	200908	1,27 €	1,52 €
HERT	NAVETTE 6,5 x 31	6	5	202165	1,42 €	1,70 €
HERT	NAVETTE 6,5 x 31	12	3	200217	1,19 €	1,43 €
HERT	NAVETTE 6,5 x 31	12	5	202175	1,58 €	1,90 €
HERT	NAVETTE 6,5 x 36	6	3	200216	1,17 €	1,40 €
HERT	NAVETTE 6,5 x 38	6	5	202105	1,42 €	1,70 €
HERT	NAVETTE 6,5 x 38	12	5	202115	1,44 €	1,73 €
HERT	NAVETTE 8,5 x 31	6	5	200201	1,01 €	1,21 €
HERT	NAVETTE 10,5 x 38	6	5	200203	1,09 €	1,31 €
HERT	NAVETTE 10,5 x 38	6	10	200214	1,28 €	1,54 €
HERT	NAVETTE 10,5 x 38	6	15	200218	1,28 €	1,54 €
HERT	NAVETTE 10,5 x 38	12	5	200204	1,09 €	1,31 €
HERT	NAVETTE 10,5 x 38	12	10	200215	0,99 €	1,19 €
HERT	NAVETTE 10,5 x 38	12	15	200219	1,21 €	1,45 €
HERT	NAVETTE 15 x 43	6	18	201230	1,53 €	1,84 €
HERT	NAVETTE 15 x 43	12	15	201221	1,80 €	2,16 €
HERT	NAVETTE 15 x 43	12	18	201231	1,60 €	1,92 €
HERT	NAVETTE 15 x 43	12	20	200977	1,55 €	1,86 €
HERT	NAVETTE 15 x 44	6	15	201220	1,53 €	1,84 €
HERT	NAVETTE 15 x 44	6	20	200972	1,55 €	1,86 €

Wedge

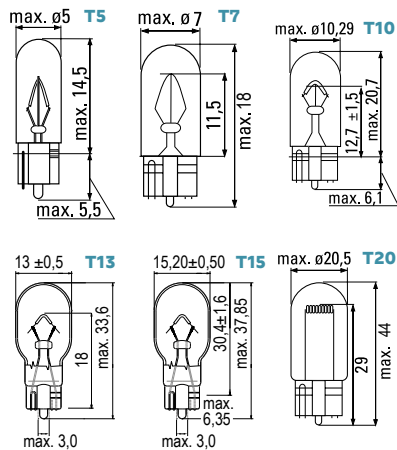

Marque	Désignation	V	W	Référence	€ H.T.	€ T.T.C.
HERT	T5	6	1,2	201706	1,09 €	1,31 €
PHILIPS	T5	12	1,2	2012516	1,21 €	1,45 €
HERT	T5	12	1,2	201702	1,13 €	1,36 €
HERT	T5	12	2	201703	1,09 €	1,31 €
HERT	T5	12	2,3	201704	1,10 €	1,32 €
HERT	T7	12	3	201750	1,73 €	2,08 €
HERT	T10	6	3	201710	1,19 €	1,43 €
HERT	T10	12	2	201711	1,07 €	1,28 €
HERT	T10	12	3	201712	1,11 €	1,33 €
HERT	T10	12	5	201715	0,95 €	1,14 €
PHILIPS	T10 - WY5W - orange	12	5	2012396	2,54 €	3,05 €
HERT	T10 orange en verre	12	5	201239	0,91 €	1,09 €
HERT	T10 orange	12	10	201240	2,27 €	2,72 €
HERT	T13	12	10	201751	1,23 €	1,48 €
HERT	T13 orange	12	10	201758	1,51 €	1,81 €
HERT	T13 orange en verre	12	21	201755	3,09 €	3,71 €
HERT	T15	12	16	201757	1,36 €	1,63 €
HERT	T15 orange	12	18	201756	7,32 €	8,78 €
HERT	T20	12	21	201753	7,31 €	8,77 €
HERT	T20	12	5/21	201754	7,93 €	9,52 €
HERT	T20 orange	12	5/21	201764	5,97 €	7,16 €



PIÈCES TECHNIQUES

ROULEMENTS /
JOINTS SPI /
KITS BIELLETTES /







GUIDE D'APPLICATION PIÈCES TECHNIQUES







CHÂSSIS	558
MOTEUR	596
SUSPENSIONS	602
ROUES	638
ROULEMENTS COLONNE DE DIRECTION	652







Cyl	Modèle	Année	ROULEMENTS DE BRAS OSCILLANT				KIT DE RÉPARATION DE BIELLETES			
				€ T.T.C.		€ T.T.C.		€ T.T.C.		€ T.T.C.
APRILIA										
180	Quasar (quad)	04-04								
180	Quasar Grip (quad)	04-04								
240	Climber (trial)	89-89								
275	Climber (trial)	89-89								
280	Climber R(trial)	92-92								
350	Tuareg	86-89								
ARCTIC CAT										
250	Cat 2x4 250	06-09	41281056	68,10€						
300	Cat 4x4 300	10-11	41281056	68,10€						
BETA										
50	RR50 Enduro Factory	15-16								
50	RR50 Enduro Std	15-15								
80	Evo 80 Junior (Trial) 17/19 pouces	15-15								
80	Evo 80 Senior (Trial)	15-15								
125	Alp 125	05-05								
125	Evo 125 (Trial)	12-14	41281219	80,90€			41271187	111,70€		
125	Evo 125 (Trial)	15-22	41281219	80,90€			41271187	111,70€		
125	RR125 Enduro	15-16								
125	RR125 Enduro	19-22	41281125	63,40€	SAKB001	74,90€	41271185	111,70€	LRKB001	98,90€
125	RR125 Enduro LC 4T	15-17								
200	Alp 200	05-21								
200	EVO (Tial)	12-14	41281219	80,90€			41271187	111,70€		
200	EVO (Tial)	15-20	41281219	80,90€			41271187	111,70€		
200	RR200 Enduro	19-22	41281125	63,40€	SAKB001	74,90€	41271185	111,70€	LRKB001	98,90€
200	Urban	15-16								
250	EVO (Trial)	12-14	41281219	80,90€			41271187	111,70€		
250	EVO (Trial)	15-22	41281219	80,90€			41271187	111,70€		
250	EVO (Trial) 4T	12-14	41281219	80,90€			41271187	111,70€		
250	EVO (Trial) 4T	15-19	41281219	80,90€			41271187	111,70€		
250	RR250	05-07								
250	RR250 Enduro	13-15							LRKB001	98,90€
250	RR250 Enduro 2T	13-22	41281125	63,40€	SAKB001	74,90€	41271185	111,70€	LRKB001	98,90€
250	XTrainer	18-22	41281125	63,40€	SAKB001	74,90€	41271185	111,70€	LRKB001	98,90€
300	300RR Enduro	13-17	41281125	63,40€	SAKB001	74,90€	41271185	111,70€	LRKB001	98,90€
300	300RR Enduro 2T	13-14	41281125	63,40€	SAKB001	74,90€	41271185	111,70€	LRKB001	98,90€
300	300RR Enduro 2T	15-22	41281125	63,40€	SAKB001	74,90€	41271185	111,70€	LRKB001	98,90€
300	EVO (Trial)	09-14	41281219	80,90€			41271187	111,70€		
300	EVO (Trial)	15-22	41281219	80,90€			41271187	111,70€		
300	EVO (Trial) 4T	12-14	41281219	80,90€			41271187	111,70€		
300	EVO (Trial) 4T	15-22	41281219	80,90€			41271187	111,70€		
300	XTrainer	18-22	41281125	63,40€	SAKB001	74,90€	41271185	111,70€	LRKB001	98,90€
350	350RR Enduro	12-15	41281125	63,40€	SAKB001	74,90€	41271185	111,70€	LRKB001	98,90€
350	350RR Enduro	16-16	41281125	63,40€	SAKB001	74,90€	41271185	111,70€	LRKB001	98,90€
350	350RR Enduro	17-22	41281125	63,40€	SAKB001	74,90€	41271185	111,70€	LRKB001	98,90€
350	Alp 4.0 350	05-05			SAKB001	74,90€				
350	Motard 4.0 350	05-05			SAKB001	74,90€				
390	RR390 Enduro	14-14	41281125	63,40€	SAKB001	74,90€	41271185	111,70€	LRKB001	98,90€
390	RR390 Enduro	15-22	41281125	63,40€	SAKB001	74,90€	41271185	111,70€	LRKB001	98,90€
400	RR400 Enduro	05-09	41281125	63,40€	SAKB001	74,90€				
400	RR400 Enduro	10-10	41281125	63,40€	SAKB001	74,90€	41271185	111,70€	LRKB001	98,90€
400	RR400 Enduro	11-15	41281125	63,40€	SAKB001	74,90€	41271185	111,70€	LRKB001	98,90€
430	RR430 Enduro	13-13	41281125	63,40€	SAKB001	74,90€	41271185	111,70€	LRKB001	98,90€
430	RR430 Enduro	14-22	41281125	63,40€	SAKB001	74,90€	41271185	111,70€	LRKB001	98,90€
450	RR450 Enduro	05-09	41281125	63,40€	SAKB001	74,90€				
450	RR450 Enduro	10-10	41281125	63,40€	SAKB001	74,90€	41271185	111,70€	LRKB001	98,90€
450	RR450 Enduro	11-15	41281125	63,40€	SAKB001	74,90€	41271185	111,70€	LRKB001	98,90€
480	RR480 Enduro	13-14	41281125	63,40€	SAKB001	74,90€	41271185	111,70€	LRKB001	98,90€
480	RR480 Enduro	15-22	41281125	63,40€	SAKB001	74,90€	41271185	111,70€	LRKB001	98,90€
498	RR498 Enduro	12-15	41281125	63,40€	SAKB001	74,90€	41271185	111,70€	LRKB001	98,90€
520	RR520 Enduro	13-14	41281125	63,40€	SAKB001	74,90€	41271185	111,70€	LRKB001	98,90€







Cyl	Modèle	Année	JOINT AMORT. HAUT		ROUL. AMORT. HAUT		ROUL. AMORT. BAS		ROUL. AMORT. BAS		ROULETTE DE CHÂÎNE 	
				€ T.T.C.		€ T.T.C.		€ T.T.C.		€ T.T.C.	Supérieure	€ T.T.C.
APRILIA												
180	Quasar (quad)	04-04										
180	Quasar Grip (quad)	04-04										
240	Climber (trial)	89-89										
275	Climber (trial)	89-89										
280	Climber R(trial)	92-92										
350	Tuareg	86-89										
ARCTIC CAT												
250	Cat 2x4 250	06-09										
300	Cat 4x4 300	10-11										
BETA												
50	RR50 Enduro Factory	15-16										
50	RR50 Enduro Std	15-15										
80	Evo 80 Junior (Trial) 17/19 pouces	15-15										
80	Evo 80 Senior (Trial)	15-15										
125	Alp 125	05-05										
125	Evo 125 (Trial)	12-14		41295078	39,50€		41295078	39,50€				
125	Evo 125 (Trial)	15-22		41295078	39,50€		41295078	39,50€				
125	RR125 Enduro	15-16										
125	RR125 Enduro	19-22		41295080	81,80€		41295076	58,10€	LSAB001	24,90€		
125	RR125 Enduro LC 4T	15-17										
200	Alp 200	05-21										
200	EVO (Tial)	12-14		41295078	39,50€		41295078	39,50€				
200	EVO (Tial)	15-20		41295078	39,50€		41295078	39,50€				
200	RR200 Enduro	19-22		41295080	81,80€		41295076	58,10€	LSAB001	24,90€		
200	Urban	15-16										
250	EVO (Trial)	12-14		41295078	39,50€		41295078	39,50€				
250	EVO (Trial)	15-22		41295078	39,50€		41295078	39,50€				
250	EVO (Trial) 4T	12-14		41295078	39,50€		41295078	39,50€				
250	EVO (Trial) 4T	15-19		41295078	39,50€		41295078	39,50€				
250	RR250	05-07										
250	RR250 Enduro	13-15							LSAB001	24,90€		
250	RR250 Enduro 2T	13-22		41295080	81,80€		41295076	58,10€	LSAB001	24,90€		
250	XTrainer	18-22		41295081			41295076	58,10€	LSAB001	24,90€		
300	300RR Enduro	13-17		41295080	81,80€		41295076	58,10€	LSAB001	24,90€		
300	300RR Enduro 2T	13-14		41295080	81,80€		41295076	58,10€	LSAB001	24,90€		
300	300RR Enduro 2T	15-22		41295080	81,80€		41295076	58,10€	LSAB001	24,90€		
300	EVO (Trial)	09-14		41295078	39,50€		41295078	39,50€				
300	EVO (Trial)	15-22		41295078	39,50€		41295078	39,50€				
300	EVO (Trial) 4T	12-14		41295078	39,50€		41295078	39,50€				
300	EVO (Trial) 4T	15-22		41295078	39,50€		41295078	39,50€				
300	XTrainer	18-22		41295081			41295076	58,10€	LSAB001	24,90€		
350	350RR Enduro	12-15		41295080	81,80€		41295076	58,10€	LSAB001	24,90€		
350	350RR Enduro	16-16		41295080	81,80€		41295076	58,10€	LSAB001	24,90€		
350	350RR Enduro	17-22		41295080	81,80€		41295076	58,10€	LSAB001	24,90€		
350	Alp 4.0 350	05-05										
350	Motard 4.0 350	05-05										
390	RR390 Enduro	14-14		41295080	81,80€		41295076	58,10€	LSAB001	24,90€		
390	RR390 Enduro	15-22		41295080	81,80€		41295076	58,10€	LSAB001	24,90€		
400	RR400 Enduro	05-09		41295080	81,80€		41295076	58,10€	LSAB001	24,90€		
400	RR400 Enduro	10-10		41295080	81,80€		41295076	58,10€	LSAB001	24,90€		
400	RR400 Enduro	11-15		41295080	81,80€		41295076	58,10€	LSAB001	24,90€		
430	RR430 Enduro	13-13		41295080	81,80€		41295076	58,10€	LSAB001	24,90€		
430	RR430 Enduro	14-22		41295080	81,80€		41295076	58,10€	LSAB001	24,90€		
450	RR450 Enduro	05-09		41295080	81,80€		41295076	58,10€	LSAB001	24,90€		
450	RR450 Enduro	10-10		41295080	81,80€		41295076	58,10€	LSAB001	24,90€		
450	RR450 Enduro	11-15		41295080	81,80€		41295076	58,10€	LSAB001	24,90€		
480	RR480 Enduro	13-14		41295080	81,80€		41295076	58,10€	LSAB001	24,90€		
480	RR480 Enduro	15-22		41295080	81,80€		41295076	58,10€	LSAB001	24,90€		
498	RR498 Enduro	12-15		41295080	81,80€		41295076	58,10€	LSAB001	24,90€		
520	RR520 Enduro	13-14		41295080	81,80€		41295076	58,10€	LSAB001	24,90€		







Cyl	Modèle	Année	ROULEMENTS DE BRAS OSCILLANT				KIT DE RÉPARATION DE BIELLETES			
				€ T.T.C.		€ T.T.C.		€ T.T.C.		€ T.T.C.
BETA										
520	RR520 Enduro	15-15	41281125	63,40€	SAKB001	74,90€	41271185	111,70€	LRKB001	98,90€
525	RR525 Enduro	05-09	41281125	63,40€	SAKB001	74,90€				
FANTIC										
125	XE 125	21-22	41281060	104,50€	SAKY279	74,90€	41271170	114,00€	LRKY128	94,90€
125	XX 125	21-22	41281060	104,50€	SAKY279	74,90€	41271170	114,00€	LRKY128	94,90€
250	XEF 250	21-22	41281202	164,20€			41271171	114,00€		
250	XX 250	22-22	41281158	85,60€	SAKY275	74,90€	41271170	114,00€	LRKY128	94,90€
250	XXF 250	22-22	41281158	85,60€	SAKY283	74,90€	41271177	203,20€	LRKY132	94,90€
450	XEF 450	22-22	41281202	164,20€	SAKY283	74,90€	41271171	114,00€	LRKY132	94,90€
450	XXF 450	22-22	41281202	164,20€	SAKY283	74,90€	41271171	114,00€	LRKY132	94,90€
GAS GAS										
50	MC50	21-22	41281129	59,50€						
65	MC65	06-07	41281115	160,90€			41271118	208,00€	LRKG006	94,90€
65	MC65	21-22	41281129	59,50€						
85	MC85	21-22	41281087	185,70€	SAKT052	80,90€				
125	EC125	01-11	41281116	82,60€	SAKG009	74,90€	41271118	208,00€	LRKG006	94,90€
125	EC125	12-13	41281116	82,60€	SAKG009	74,90€				
125	MC125	01-09	41281116	82,60€	SAKG009	74,90€	41271118	208,00€	LRKG006	94,90€
125	MC125	21-22	41281125	63,40€	SAKT049	80,90€	41271202	125,50€	LRKT031	98,90€
125	SM125	02-02							LRKG006	94,90€
125	SM125	03-05			SAKG009	74,90€			LRKG006	94,90€
125	SM125	06-08	41281116	82,60€	SAKG009	74,90€	41271118	208,00€	LRKG006	94,90€
125	SM125	09-09	41281116	82,60€	SAKG009	74,90€	41271118	208,00€	LRKG006	94,90€
125	TXT125	00-03	41281131	84,56€			41271154	208,00€		
125	TXT125 Pro	04-10	41281138	136,20€			41271154	208,00€		
125	TXT125 Pro	11-14					41271154	208,00€		
125	TXT125 Pro	15-17	41281138	136,20€			41271154	208,00€		
200	EC200	99-03	41281116	82,60€	SAKG009	74,90€	41271118	208,00€	LRKG006	94,90€
200	EC200	04-11								
200	EC200	18-20	41281223	167,60€	SAKG020	88,90€	41271195	197,20€		
200	EC200 Hobby	99-02							LRKG006	94,90€
200	EC200 Hobby	03-11			SAKG009	74,90€			LRKG006	94,90€
200	EC200 Ranger	19-20	41281223	167,60€	SAKG020	88,90€	41271195	197,20€	LRKG021	98,90€
200	TXT200	00-03	41281131	84,56€			41271154	208,00€		
200	TXT200	04-09	41281138	136,20€			41271154	208,00€		
250	EC250	96-11	41281116	82,60€	SAKG009	74,90€	41271118	208,00€	LRKG006	94,90€
250	EC250	12-12								
250	EC250	18-20	41281223	167,60€	SAKG020	88,90€	41271195	197,20€	LRKG021	98,90€
250	EC250	21-22	41281125	63,40€	SAKT049	80,90€	41271180	111,60€	LRKT031	98,90€
250	EC250F	21-22	41281125	63,40€	SAKT049	80,90€	41271180	111,60€	LRKT031	98,90€
250	MC250	99-09	41281116	82,60€	SAKG009	74,90€	41271118	208,00€	LRKG006	94,90€
250	MC250	22-22	41281125	63,40€	SAKT049	80,90€	41271202	125,50€	LRKT031	98,90€
250	MC250F	21-22	41281125	63,40€	SAKT049	80,90€	41271202	125,50€	LRKT031	98,90€
250	TXT250	02-02	41281131	84,56€			41271154	208,00€		
250	TXT250	03-03	41281131	84,56€			41271154	208,00€		
250	TXT250	04-05	41281138	136,20€			41271154	208,00€		
250	TXT250	06-10	41281138	136,20€			41271154	208,00€		
250	TXT250	11-12					41271154	208,00€		
250	TXT250	13-18	41281138	136,20€			41271154	208,00€		
280	TXT280	00-03	41281131	84,56€			41271154	208,00€		
280	TXT280	04-10	41281138	136,20€			41271154	208,00€		
280	TXT280	11-14					41271154	208,00€		
280	TXT280	15-18	41281138	136,20€			41271154	208,00€		
300	EC300	99-11	41281116	82,60€	SAKG009	74,90€	41271118	208,00€	LRKG006	94,90€
300	EC300	12-13								
300	EC300	18-20	41281223	167,60€	SAKG020	88,90€	41271195	197,20€	LRKG021	98,90€
300	EC300	21-22	41281125	63,40€	SAKT049	80,90€	41271180	111,60€	LRKT031	98,90€
300	EC300 Ranger	19-20	41281223	167,60€	SAKG020	88,90€	41271195	197,20€		
300	TXT300	04-06	41281138	136,20€			41271154	208,00€		
300	TXT300 Pro	07-10	41281138	136,20€			41271154	208,00€		







Cyl	Modèle	Année	JOINT AMORT. HAUT		ROUL. AMORT. HAUT		ROUL. AMORT. BAS		ROUL. AMORT. BAS		ROULETTE DE CHAÎNE 			
				€ T.T.C.		€ T.T.C.		€ T.T.C.		€ T.T.C.	Supérieure	€ T.T.C.	Inférieure	€ T.T.C.
BETA														
520	RR520 Enduro	15-15			41295080	81,80€	41295076	58,10€	LSAB001	24,90€				
525	RR525 Enduro	05-09			41295080	81,80€	41295076	58,10€	LSAB001	24,90€				
FANTIC														
125	XE 125	21-22	41371117	51,80€	41291016	28,90€	41295015	23,30€	LSAY002	21,90€	41795007	21,40€	41795008	20,90€
125	XX 125	21-22	41371117	51,80€	41291016	28,90€	41295015	23,30€	LSAY002	21,90€	41795007	21,40€	41795008	20,90€
250	XEF 250	21-22	41371001	52,30€	41291016	28,90€	41295015	23,30€	LSAY002	21,90€	41795007	21,40€	41795008	20,90€
250	XX 250	22-22	41371117	51,80€	41291016	28,90€	41295015	23,30€	LSAY002	21,90€	41795007	21,40€	41795008	20,90€
250	XXF 250	22-22			41291016	28,90€	41295015	23,30€	LSAY002	21,90€	41795008	20,90€	41795008	20,90€
450	XEF 450	22-22	41371002	52,30€	41291016	28,90€	41295015	23,30€	LSAY002	21,90€	41795008	20,90€	41795008	20,90€
450	XXF 450	22-22			41291016	28,90€	41295015	23,30€	LSAY002	21,90€	41795008	20,90€	41795008	20,90€
GAS GAS														
50	MC50	21-22			41295070	51,20€	41295070	51,20€						
65	MC65	06-07					41295046	24,90€			41795008	20,90€	41795001	21,40€
65	MC65	21-22			41295070	51,20€	41295070	51,20€						
85	MC85	21-22	41371120	112,20€	41295059	34,40€	41295059	34,40€						
125	EC125	01-11					41295046	24,90€	LSAG001	24,90€	41795008	20,90€	41795001	21,40€
125	EC125	12-13												
125	MC125	01-09					41295046	24,90€	LSAG001	24,90€	41795008	20,90€	41795001	21,40€
125	MC125	21-22	41371127	112,20€	41295068	34,70€	41295090	29,00€	LSAT002	24,90€				
125	SM125	02-02							LSAG001	24,90€				
125	SM125	03-05							LSAG001	24,90€	41795008	20,90€	41795008	20,90€
125	SM125	06-08					41295046	24,90€	LSAG001	24,90€	41795008	20,90€	41795008	20,90€
125	SM125	09-09					41295046	24,90€			41795008	20,90€	41795008	20,90€
125	TXT125	00-03												
125	TXT125 Pro	04-10												
125	TXT125 Pro	11-14												
125	TXT125 Pro	15-17												
200	EC200	99-03					41295046	24,90€			41795008	20,90€	41795001	21,40€
200	EC200	04-11									41795008	20,90€	41795001	21,40€
200	EC200	18-20			41291016	28,90€	41295015	23,30€	LSAY002	21,90€				
200	EC200 Hobby	99-02							LSAG001	24,90€				
200	EC200 Hobby	03-11							LSAG001	24,90€				
200	EC200 Ranger	19-20			41291016	28,90€	41295015	23,30€	LSAY002	21,90€				
200	TXT200	00-03												
200	TXT200	04-09												
250	EC250	96-11					41295046	24,90€	LSAG001	24,90€	41795008	20,90€	41795001	21,40€
250	EC250	12-12											41795001	21,40€
250	EC250	18-20			41291016	28,90€	41295015	23,30€	LSAY002	21,90€				
250	EC250	21-22	41371119	114,40€	41295068	34,70€	41295066	24,90€	LSAT002	24,90€				
250	EC250F	21-22	41371127	112,20€	41295068	34,70€	41295066	24,90€	LSAT002	24,90€				
250	MC250	99-09					41295046	24,90€	LSAG001	24,90€	41795008	20,90€	41795001	21,40€
250	MC250	22-22	41371127	112,20€	41295068	34,70€	41295090	29,00€	LSAT002	24,90€				
250	MC250F	21-22	41371127	112,20€	41295068	34,70€	41295090	29,00€	LSAT002	24,90€				
250	TXT250	02-02												
250	TXT250	03-03									41795008	20,90€	41795001	21,40€
250	TXT250	04-05									41795008	20,90€	41795001	21,40€
250	TXT250	06-10												
250	TXT250	11-12												
250	TXT250	13-18												
280	TXT280	00-03												
280	TXT280	04-10												
280	TXT280	11-14												
280	TXT280	15-18												
300	EC300	99-11					41295046	24,90€	LSAG001	24,90€	41795008	20,90€	41795001	21,40€
300	EC300	12-13									41795008	20,90€	41795001	21,40€
300	EC300	18-20			41291016	28,90€	41295015	23,30€	LSAY002	21,90€				
300	EC300	21-22	41371120	112,20€	41295068	34,70€	41295066	24,90€	LSAT002	24,90€				
300	EC300 Ranger	19-20			41291016	28,90€								
300	TXT300	04-06												
300	TXT300 Pro	07-10												







Cyl	Modèle	Année	ROULEMENTS DE BRAS OSCILLANT				KIT DE RÉPARATION DE BIELLETES			
				€ T.T.C.		€ T.T.C.		€ T.T.C.		€ T.T.C.
GAS GAS										
300	TXT300 Pro	11-14						41271154	208,00€	
300	TXT300 Pro	15-18	41281138	136,20€				41271154	208,00€	
350	EC350F	21-22	41281125	63,40€	SAKT049	80,90€		41271180	111,60€	LRKT031 98,90€
350	MC350F	22-22	41281125	63,40€	SAKT049	80,90€		41271202	125,50€	LRKT031 98,90€
400	EC400 FSE	03-05								
450	EC450 FSE	99-02								LRKG006 94,90€
450	EC450 FSE	03-05	41281116	82,60€	SAKG009	74,90€		41271118	208,00€	LRKG006 94,90€
450	EC450 FSE	06-06	41281116	82,60€	SAKG009	74,90€		41271118	208,00€	LRKG006 94,90€
450	EC450 FSR	07-09	41281116	82,60€	SAKG009	74,90€		41271118	208,00€	LRKG006 94,90€
450	MC450F	21-22	41281125	63,40€	SAKT049	80,90€		41271180	111,60€	LRKT031 98,90€
HM										
125	CRE125 Enduro	02-04								LRKH165 94,90€
125	CRE125 Enduro	05-06								LRKH166 94,90€
250	CRE250 Enduro	03-04								LRKH165 94,90€
250	CRE250 Enduro	05-06								LRKH169 94,90€
250	CRE250 F Enduro	04-04								LRKH165 94,90€
250	CRE250 F Enduro	05-06								LRKH166 94,90€
450	CRE450 F Enduro	02-04								LRKH166 94,90€
450	CRE450 F Enduro	05-05								LRKH169 94,90€
450	CRE450 X Enduro	04-06								LRKH169 94,90€
450	CRE450 X Enduro	07-13								LRKH174 94,90€
HONDA										
50	CRF50	04-22	41281163	118,40€						
50	XR50	00-03	41281163	118,40€						
70	CRF70	04-13	41281163	118,40€						
70	XR70 R	95-03	41281163	118,40€						
80	CR80 R	85-85						41271111	103,20€	
80	CR80 R	86-86	41281017	67,69€				41271111	103,20€	
80	CR80 R	87-87	41281017	67,69€				41271111	103,20€	
80	CR80 R	88-95	41281017	67,69€				41271009	106,39€	
80	CR80 R	96-97	41281016	78,38€				41271045	76,70€	
80	CR80 R	98-99	41281018	67,69€				41271045	76,70€	
80	CR80 R	00-02	41281019	61,50€				41271045	76,70€	
80	CR80 R	02-02	41281019	61,50€				41271045	76,70€	
80	CRF80	04-09	41281090	114,30€				41271091	205,10€	
80	XR80	86-90	41281090	114,30€				41271091	205,10€	
80	XRR80	85-91	41281090	114,30€				41271091	205,10€	
85	CR85	03-08	41281019	61,50€				41271045	76,70€	
100	CRF100	04-13	41281090	114,30€				41271090	201,00€	
100	XRR100	85-00	41281090	114,30€				41271091	205,10€	
100	XRR100	01-04	41281090	114,30€				41271090	201,00€	
125	CR125 R	81-81								
125	CR125 R	82-82								
125	CR125 R	83-84								
125	CR125 R	85-85	41281013	147,00€				41271016	114,00€	
125	CR125 R	86-86	41281014	81,92€				41271016	114,00€	
125	CR125 R	87-88	41281013	147,00€				41271016	114,00€	
125	CR125 R	89-89	41281030	81,92€				41271026	114,00€	
125	CR125 R	90-90	41281029	152,30€				41271026	114,00€	
125	CR125 R	91-92	41281030	81,92€				41271019	112,80€	
125	CR125 R	93-93	41281041	164,20€	SAKH325	74,90€		41271054	114,00€	
125	CR125 R	94-95	41281041	164,20€	SAKH325	74,90€		41271029	112,80€	
125	CR125 R	96-96	41281041	164,20€	SAKH325	74,90€		41271033	112,80€	
125	CR125 R	97-97	41281041	164,20€	SAKH325	74,90€		41271035	106,84€	
125	CR125 R	98-98	41281041	164,20€	SAKH325	74,90€		41271008	106,84€	
125	CR125 R	99-99	41281041	164,20€	SAKH325	74,90€		41271008	106,84€	
125	CR125 R	00-01	41281041	164,20€	SAKH325	74,90€		41271003	112,80€	LRKH159 94,90€
125	CR125 R	02-04	41281040	158,70€	SAKH341	74,90€		41271125	112,80€	LRKH165 94,90€
125	CR125 R	05-07	41281040	158,70€	SAKH341	74,90€		41271125	112,80€	LRKH166 94,90€
125	CRF125 F	14-21								









Cyl	Modèle	Année	JOINT AMORT. HAUT		ROUL. AMORT. HAUT		ROUL. AMORT. BAS		ROUL. AMORT. BAS		ROULETTE DE CHAÎNE 			
				€ T.T.C.		€ T.T.C.		€ T.T.C.		€ T.T.C.	Supérieure	€ T.T.C.	Inférieure	€ T.T.C.
GAS GAS														
300	TXT300 Pro	11-14												
300	TXT300 Pro	15-18												
350	EC350F	21-22	41371120	112,20€	41295068	34,70€	41295066	24,90€	LSAT002	24,90€				
350	MC350F	22-22	41371120	112,20€	41295068	34,70€	41295090	29,00€	LSAT002	24,90€				
400	EC400 FSE	03-05									41795008	20,90€	41795001	21,40€
450	EC450 FSE	99-02							LSAG001	24,90€				
450	EC450 FSE	03-05					41295046	24,90€	LSAG001	24,90€	41795008	20,90€	41795001	21,40€
450	EC450 FSE	06-06					41295046	24,90€	LSAG001	24,90€				
450	EC450 FSR	07-09					41295046	24,90€	LSAG001	24,90€				
450	MC450F	21-22	41371127	112,20€	41295068	34,70€	41295066	24,90€	LSAT002	24,90€				
HM														
125	CRE125 Enduro	02-04												
125	CRE125 Enduro	05-06												
250	CRE250 Enduro	03-04												
250	CRE250 Enduro	05-06												
250	CRE250 F Enduro	04-04												
250	CRE250 F Enduro	05-06												
450	CRE450 F Enduro	02-04												
450	CRE450 F Enduro	05-05												
450	CRE450 X Enduro	04-06												
450	CRE450 X Enduro	07-13												
HONDA														
50	CRF50	04-22												
50	XR50	00-03												
70	CRF70	04-13												
70	XR70 R	95-03												
80	CR80 R	85-85						41295048	27,12€					
80	CR80 R	86-86						41295048	27,12€					
80	CR80 R	87-87	41371005	101,10€				41295048	27,12€					
80	CR80 R	88-95	41371005	101,10€	41291001	49,80€	41295031	25,14€						
80	CR80 R	96-97	41371006	97,00€	41295055	50,80€	41295018	19,00€			41795011	20,50€		
80	CR80 R	98-99	41371006	97,00€	41295055	50,80€	41295018	19,00€			41795011	20,50€		
80	CR80 R	00-02	41371006	97,00€	41295055	50,80€	41295018	19,00€			41795011	20,50€		
80	CR80 R	02-02	41371006	97,00€	41295055	50,80€	41295018	19,00€			41795011	20,50€		
80	CRF80	04-09						41295017	38,30€					
80	XR80	86-90						41295017	38,30€					
80	XRR80	85-91						41295017	38,30€					
85	CR85	03-08	41371006	97,00€	41295055	50,80€	41295018	19,00€			41795011	20,50€		
100	CRF100	04-13						41295017	38,30€					
100	XRR100	85-00						41295017	38,30€					
100	XRR100	01-04						41295017	38,30€					
125	CR125 R	81-81									41795002	21,40€	41795002	21,40€
125	CR125 R	82-82									41795008	20,90€	41795006	21,40€
125	CR125 R	83-84									41795006	21,40€	41795006	21,40€
125	CR125 R	85-85						41291017	56,40€		41795008	20,90€	41795006	21,40€
125	CR125 R	86-86						41291017	56,40€		41795008	20,90€	41795006	21,40€
125	CR125 R	87-88						41291017	56,40€		41795008	20,90€	41795006	21,40€
125	CR125 R	89-89	41371007	52,30€	41291006	49,80€	41295029	51,30€			41795008	20,90€	41795006	21,40€
125	CR125 R	90-90	41371007	52,30€	41291006	49,80€	41295029	51,30€			41795008	20,90€	41795006	21,40€
125	CR125 R	91-92	41371007	52,30€	41291006	49,80€	41295006	25,60€			41795008	20,90€	41795006	21,40€
125	CR125 R	93-93	41371004	52,90€	41291006	49,80€	41295006	25,60€			41795008	20,90€	41795008	20,90€
125	CR125 R	94-95	41371004	52,90€	41291012	29,20€	41295004	51,20€			41795008	20,90€	41795008	20,90€
125	CR125 R	96-96	41371004	52,90€	41291013	28,90€	41295005	53,00€			41795008	20,90€	41795008	20,90€
125	CR125 R	97-97	41371004	52,90€	41291013	28,90€	41295008	22,30€	LSAH004	24,90€	41795011	20,50€	41795008	20,90€
125	CR125 R	98-98	41371004	52,90€	41291013	28,90€	41295008	22,30€	LSAH004	24,90€	41795008	20,90€	41795008	20,90€
125	CR125 R	99-99	41371004	52,90€	41291013	28,90€	41295008	22,30€	LSAH004	24,90€	41795007	21,40€	41795008	20,90€
125	CR125 R	00-01	41371004	52,90€	41291013	28,90€	41295008	22,30€	LSAH004	24,90€	41795008	20,90€	41795007	21,40€
125	CR125 R	02-04	41371004	52,90€	41291013	28,90€	41295008	22,30€	LSAH004	24,90€	41795008	20,90€	41795007	21,40€
125	CR125 R	05-07	41371004	52,90€	41291013	28,90€	41295008	22,30€	LSAH006	21,90€	41795007	21,40€	41795007	21,40€
125	CRF125 F	14-21											41795013	9,10€







Cyl	Modèle	Année	ROULEMENTS DE BRAS OSCILLANT				KIT DE RÉPARATION DE BIELLETTES				
				€ T.T.C.		€ T.T.C.		€ T.T.C.		€ T.T.C.	
HONDA											
150	CRF150 F	03-13	41281099	119,00€				41271098	190,80€	LRKH167	-
150	CRF150 F	14-14	41281099	119,00€				41271098	190,80€	LRKH167	-
150	CRF150 R (17"/14")	07-15	41281019	61,50€				41271153	201,90€	LRKH173	-
150	CRF150 RB (19"/16")	07-14	41281019	61,50€				41271153	201,90€	LRKH173	-
150	CRF150 RB (19"/16")	15-15	41281019	61,50€				41271153	201,90€	LRKH173	-
200	TRX 200	84-84	41281056	68,10€							
230	CRF230 F	03-03	41281099	119,00€							
230	CRF230 F	04-14	41281099	119,00€				41271098	190,80€		
250	CR250 R	88-88	41281030	81,92€				41271158	107,90€		
250	CR250 R	89-90	41281030	81,92€				41271026	114,00€		
250	CR250 R	91-91	41281030	81,92€				41271019	112,80€		
250	CR250 R	92-92	41281039	164,20€	SAKH329	74,90€		41271054	114,00€		
250	CR250 R	93-93	41281039	164,20€	SAKH329	74,90€		41271054	114,00€		
250	CR250 R	94-94	41281039	164,20€	SAKH329	74,90€		41271029	112,80€		
250	CR250 R	95-95	41281039	164,20€	SAKH329	74,90€		41271029	112,80€		
250	CR250 R	96-96	41281039	164,20€	SAKH329	74,90€		41271033	112,80€		
250	CR250 R	97-97	41281039	164,20€	SAKH329	74,90€		41271007	112,80€		
250	CR250 R	98-98	41281039	164,20€	SAKH329	74,90€		41271008	106,84€		
250	CR250 R	99-99	41281039	164,20€	SAKH329	74,90€		41271008	106,84€		
250	CR250 R	00-01	41281039	164,20€	SAKH329	74,90€		41271003	112,80€	LRKH159	94,90€
250	CR250 R	02-03	41281037	160,90€	SAKH342	74,90€		41271125	112,80€	LRKH165	94,90€
250	CR250 R	04-04	41281037	160,90€	SAKH342	74,90€		41271125	112,80€	LRKH165	94,90€
250	CR250 R	05-08	41281037	160,90€	SAKH342	74,90€		41271125	112,80€	LRKH169	94,90€
250	CRF250 R	04-04	41281127	160,90€	SAKH349	74,90€		41271125	112,80€	LRKH165	94,90€
250	CRF250 R	05-05	41281127	160,90€	SAKH349	74,90€		41271125	112,80€	LRKH166	94,90€
250	CRF250 R	06-09	41281127	160,90€	SAKH349	74,90€		41271125	112,80€	LRKH166	94,90€
250	CRF250 R	10-13	41281128	160,90€	SAKH352	74,90€		41271172	112,80€	LRKH174	94,90€
250	CRF250 R	14-16	41281206	176,20€	SAKH354	74,90€		41271172	112,80€	LRKH174	94,90€
250	CRF250 R	17-17	41281206	176,20€	SAKH354	74,90€		41271172	112,80€	LRKH174	94,90€
250	CRF250 R	18-19	41281218	183,50€				41271186	215,80€	LRKH177	-
250	CRF250 R	20-22	41281222	167,40€				41271186	215,80€	LRKH177	-
250	CRF250 RX	20-22	41281222	167,40€				41271186	215,80€	LRKH177	-
250	CRF250 X	04-05	41281127	160,90€	SAKH349	74,90€		41271125	112,80€	LRKH170	94,90€
250	CRF250 X	06-15	41281127	160,90€	SAKH349	74,90€		41271125	112,80€	LRKH169	94,90€
250	TRX250 R /Fourtrax [US]	86-89	41281056	68,10€							
250	TRX250 Sportrax EX	01-08	41281056	68,10€							
250	TRX250 X	10-12	41281056	68,10€							
300	CRF300 RX	21-22	41281222	167,40€				41271186	215,80€	LRKH177	-
300	TRX300 Sportrax EX	00-00	41281056	68,10€							
350	TRX350 FE /TE /FM	00-06	41281056	68,10€							
400	CRF400 RX	21-22	41281222	167,40€				41271186	215,80€	LRKH177	-
400	TRX Foreman	95-03	41281056	68,10€							
400	TRX400 Fourtrax	99-03	41281056	68,10€							
400	XR400 R	96-97	41281012	80,15€				41271049	212,10€		
400	XR400 R	98-04	41281012	80,15€				41271047	212,10€		
400	XR400 R	05-06	41281012	80,15€				41271047	212,10€		
400	XR400 Supermotard	96-06									
450	CR450 R	81-81									
450	CRF450 R	02-04	41281037	160,90€	SAKH342	74,90€		41271125	112,80€	LRKH165	94,90€
450	CRF450 R	05-08	41281128	160,90€	SAKH350	74,90€		41271125	112,80€	LRKH169	94,90€
450	CRF450 R	09-09	41281128	160,90€	SAKH352	74,90€		41271172	112,80€	LRKH174	94,90€
450	CRF450 R	10-11	41281128	160,90€	SAKH352	74,90€		41271172	112,80€	LRKH174	94,90€
450	CRF450 R	12-12	41281128	160,90€	SAKH352	74,90€		41271172	112,80€	LRKH174	94,90€
450	CRF450 R	13-13	41281206	176,20€	SAKH354	74,90€		41271172	112,80€	LRKH174	94,90€
450	CRF450 R	14-14	41281206	176,20€	SAKH354	74,90€		41271172	112,80€	LRKH174	94,90€
450	CRF450 R	15-16	41281206	176,20€	SAKH354	74,90€		41271172	112,80€	LRKH174	94,90€
450	CRF450 R	17-17	41281218	183,50€				41271186	215,80€	LRKH177	-
450	CRF450 R	18-18	41281218	183,50€				41271186	215,80€	LRKH177	-
450	CRF450 R	19-22	41281222	167,40€				41271186	215,80€	LRKH177	-
450	CRF450 RX	17-18	41281218	183,50€				41271186	215,80€	LRKH177	-



Cyl	Modèle	JOINT AMORT. HAUT		ROUL. AMORT. HAUT		ROUL. AMORT. BAS		ROUL. AMORT. BAS		ROULETTE DE CHÂÎNE 				
		Année	 € T.T.C.	 € T.T.C.	 € T.T.C.	 € T.T.C.	 € T.T.C.	 € T.T.C.	Supérieure	€ T.T.C.	Inférieure	€ T.T.C.		
HONDA														
150	CRF150 F	03-13				41295019	38,30€					41795013	9,10€	
150	CRF150 F	14-14				41295019	38,30€							
150	CRF150 R (17"/14")	07-15	41371006	97,00€	41295055	50,80€	41291023	55,20€			41795011	20,50€		
150	CRF150 RB (19"/16")	07-14	41371006	97,00€	41295055	50,80€	41291023	55,20€			41795011	20,50€		
150	CRF150 RB (19"/16")	15-15			41295055	50,80€	41291023	55,20€			41795011	20,50€		
200	TRX 200	84-84												
230	CRF230 F	03-03												
230	CRF230 F	04-14				41295019	38,30€					41795013	9,10€	
250	CR250 R	88-88	41371114	97,10€							41795008	20,90€	41795006	21,40€
250	CR250 R	89-90	41371114	97,10€	41291028	35,60€	41295029	51,30€			41795008	20,90€	41795006	21,40€
250	CR250 R	91-91	41371007	52,30€	41291006	49,80€	41295006	25,60€			41795006	21,40€	41795006	21,40€
250	CR250 R	92-92			41291006	49,80€	41295006	25,60€			41795008	20,90€	41795008	20,90€
250	CR250 R	93-93	41371113	97,10€	41291006	49,80€	41295006	25,60€			41795008	20,90€	41795008	20,90€
250	CR250 R	94-94	41371113	97,10€	41291006	49,80€	41295004	51,20€			41795008	20,90€	41795008	20,90€
250	CR250 R	95-95	41371004	52,90€	41291012	29,20€	41295004	51,20€			41795008	20,90€	41795008	20,90€
250	CR250 R	96-96	41371004	52,90€	41291012	29,20€	41295005	53,00€			41795008	20,90€	41795006	21,40€
250	CR250 R	97-97	41371113	97,10€	41291013	28,90€	41295008	22,30€	LSAH004	24,90€	41795008	20,90€	41795008	20,90€
250	CR250 R	98-98	41371113	97,10€	41291013	28,90€	41295008	22,30€	LSAH004	24,90€	41795008	20,90€	41795006	21,40€
250	CR250 R	99-99	41371113	97,10€	41291013	28,90€	41295008	22,30€	LSAH004	24,90€	41795008	20,90€	41795007	21,40€
250	CR250 R	00-01	41371001	52,30€	41291013	28,90€	41295008	22,30€	LSAH004	24,90€	41795008	20,90€	41795007	21,40€
250	CR250 R	02-03	41371126	105,40€	41291013	28,90€	41295008	22,30€	LSAH004	24,90€	41795007	21,40€	41795008	20,90€
250	CR250 R	04-04	41371126	105,40€	41291013	28,90€	41295008	22,30€	LSAH004	24,90€	41795007	21,40€	41795010	21,30€
250	CR250 R	05-08	41371126	105,40€	41291013	28,90€	41295008	22,30€	LSAH006	21,90€	41795015	20,90€	41795010	21,30€
250	CRF250 R	04-04	41371126	105,40€	41291013	28,90€	41295008	22,30€	LSAH004	24,90€	41795007	21,40€	41795007	21,40€
250	CRF250 R	05-05	41371126	105,40€	41291013	28,90€	41295008	22,30€	LSAH004	24,90€	41795015	20,90€	41795007	21,40€
250	CRF250 R	06-09	41371126	105,40€	41291013	28,90€	41295008	22,30€	LSAH006	21,90€	41795015	20,90€	41795007	21,40€
250	CRF250 R	10-13	41371126	105,40€	41291013	28,90€	41295008	22,30€	LSAH006	21,90€	41795014	28,80€	41795014	28,80€
250	CRF250 R	14-16	41371126	105,40€	41291013	28,90€	41295008	22,30€	LSAH006	21,90€	41795014	28,80€	41795014	28,80€
250	CRF250 R	17-17	41371126	105,40€	41291013	28,90€	41295008	22,30€	LSAH006	21,90€	41795015	20,90€	41795014	28,80€
250	CRF250 R	18-19	41371126	105,40€	41291013	28,90€	41295008	22,30€	LSAH006	21,90€	41795015	20,90€	41795015	20,90€
250	CRF250 R	20-22	41371126	105,40€	41291013	28,90€	41295008	22,30€	LSAH006	21,90€	41795015	20,90€	41795015	20,90€
250	CRF250 RX	20-22	41371126	105,40€	41291013	28,90€	41295008	22,30€	LSAH006	21,90€	41795015	20,90€	41795015	20,90€
250	CRF250 X	04-05	41371126	105,40€	41291013	28,90€	41295008	22,30€	LSAH004	24,90€	41795007	21,40€	41795010	21,30€
250	CRF250 X	06-15	41371126	105,40€	41291013	28,90€	41295008	22,30€	LSAH006	21,90€	41795015	20,90€	41795010	21,30€
250	TRX250 R /Fourtrax [US]	86-89												
250	TRX250 Sportrax EX	01-08												
250	TRX250 X	10-12												
300	CRF300 RX	21-22	41371126	105,40€	41291013	28,90€	41295008	22,30€	LSAH006	21,90€	41795015	20,90€	41795015	20,90€
300	TRX300 Sportrax EX	00-00												
350	TRX350 FE /TE /FM	00-06												
400	CRF400 RX	21-22	41371126	105,40€	41291013	28,90€	41295008	22,30€	LSAH006	21,90€	41795015	20,90€	41795015	20,90€
400	TRX Foreman	95-03												
400	TRX400 Fourtrax	99-03												
400	XR400 R	96-97	41371114	97,10€	41291028	35,60€	41291018	55,30€			41795008	20,90€	41795013	9,10€
400	XR400 R	98-04	41371114	97,10€	41291001	49,80€	41295019	38,30€			41795008	20,90€	41795013	9,10€
400	XR400 R	05-06					41295019	38,30€			41795008	20,90€	41795013	9,10€
400	XR400 Supermotard	96-06									41795008	20,90€	41795013	9,10€
450	CR450 R	81-81									41795002	21,40€	41795002	21,40€
450	CRF450 R	02-04	41371126	105,40€	41291013	28,90€	41295008	22,30€	LSAH004	24,90€	41795007	21,40€	41795007	21,40€
450	CRF450 R	05-08	41371126	105,40€	41291013	28,90€	41295008	22,30€	LSAH006	21,90€	41795014	28,80€	41795007	21,40€
450	CRF450 R	09-09	41371126	105,40€	41291013	28,90€	41295008	22,30€	LSAH006	21,90€	41795014	28,80€	41795007	21,40€
450	CRF450 R	10-11	41371001	52,30€	41291013	28,90€	41295008	22,30€	LSAH006	21,90€	41795014	28,80€	41795014	28,80€
450	CRF450 R	12-12	41371001	52,30€	41291013	28,90€	41295008	22,30€	LSAH006	21,90€	41795015	20,90€	41795014	28,80€
450	CRF450 R	13-13	41371001	52,30€	41291013	28,90€	41295008	22,30€	LSAH006	21,90€	41795015	20,90€	41795014	28,80€
450	CRF450 R	14-14	41371001	52,30€	41291013	28,90€	41295008	22,30€	LSAH006	21,90€	41795014	28,80€	41795015	20,90€
450	CRF450 R	15-16	41371001	52,30€	41291013	28,90€	41295008	22,30€	LSAH006	21,90€	41795014	28,80€	41795014	28,80€
450	CRF450 R	17-17	41371001	52,30€	41291013	28,90€	41295008	22,30€	LSAH006	21,90€	41795015	20,90€	41795014	28,80€
450	CRF450 R	18-18	41371126	105,40€	41291013	28,90€	41295008	22,30€	LSAH006	21,90€	41795015	20,90€	41795015	20,90€
450	CRF450 R	19-22	41371126	105,40€	41291013	28,90€	41295008	22,30€	LSAH006	21,90€	41795015	20,90€	41795015	20,90€
450	CRF450 RX	17-18	41371126	105,40€	41291013	28,90€	41295008	22,30€	LSAH006	21,90€	41795015	20,90€	41795015	20,90€







Cyl	Modèle	Année	ROULEMENTS DE BRAS OSCILLANT				KIT DE RÉPARATION DE BIELLETES				
				€ T.T.C.		€ T.T.C.		€ T.T.C.		€ T.T.C.	
HONDA											
450	CRF450 RX	19-22	41281222	167,40€				41271186	215,80€	LRKH177	-
450	CRF450 X	05-18	41281128	160,90€	SAKH350	74,90€		41271125	112,80€	LRKH169	94,90€
450	CRF450 X	19-20	41281218	183,50€				41271186	215,80€	LRKH177	-
450	TRX450 R	04-09									
480	CR480 R	82-83	41281142	67,69€							
500	CR500 R	84-84	41281142	67,69€							
500	CR500 R	85-85	41281013	147,00€				41271016	114,00€		
500	CR500 R	86-86	41281014	81,92€				41271016	114,00€		
500	CR500 R	87-87	41281013	147,00€				41271016	114,00€		
500	CR500 R	88-88	41281013	147,00€				41271016	114,00€		
500	CR500 R	89-90	41281030	81,92€				41271026	114,00€		
500	CR500 R	91-92	41281030	81,92€				41271019	112,80€		
500	CR500 R	93-93	41281030	81,92€				41271021	106,84€		
500	CR500 R	94-94	41281030	81,92€				41271021	106,84€		
500	CR500 R	95-95	41281030	81,92€				41271024	106,84€		
500	CR500 R	96-01	41281030	81,92€				41271025	192,90€		
500	CR500 R	02-02	41281030	81,92€				41271025	192,90€		
500	XR500 R	81-81	41281101	145,70€							
500	XR500 R	82-82	41281101	145,70€							
500	XR500 R	83-84	41281054	149,30€							
600	XR600 R	85-87	41281054	149,30€				41271046	112,80€		
600	XR600 R	88-90	41281020	82,60€				41271046	112,80€		
600	XR600 R [FR]	91-00	41281020	82,60€				41271046	112,80€		
650	XR650 L [US]	93-13	41281020	82,60€				41271046	112,80€		
650	XR650 R	00-07	41281108	81,92€				41271112	186,50€		
HUSABERG											
125	TE125 2T	11-16									
250	FE250 4T	13-14	41281168	64,80€	SAKT048	80,90€					
250	TE250 2T	11-14	41281168	64,80€	SAKT048	80,90€					
300	TE300 2T	13-14	41281168	64,80€	SAKT048	80,90€					
350	FE350 4T	13-14									
390	FE390 Enduro	10-12	41281125	63,40€	SAKT049	80,90€					
450	FC450	04-04	41281178	111,40€							
450	FC450	05-05	41281179	111,40€							
450	FC450	06-06	41281179	111,40€							
450	FE450	09-11	41281125	63,40€	SAKT049	80,90€					
450	FE450	12-12	41281125	63,40€	SAKT049	80,90€					
450	FE450	12-12	41281125	63,40€	SAKT049	80,90€					
450	FE450	13-14	41281125	63,40€	SAKT049	80,90€					
450	FE450 E	04-04	41281178	111,40€							
450	FE450 E	05-08	41281179	111,40€							
450	FS450 E /C	03-04	41281178	111,40€							
450	FS450 E /C	05-08	41281179	111,40€							
501	FE501	13-13	41281168	64,80€	SAKT048	80,90€					
501	FE501	14-14	41281125	63,40€	SAKT049	80,90€					
550	FE550 /E	07-08	41281179	111,40€							
570	FE570 Enduro	09-12	41281125	63,40€	SAKT049	80,90€					
650	FE650 E	04-04									
650	FE650 E	05-08	41281179	111,40€							
650	FS650 C /E	04-08									
HUSQVARNA											
50	TC 50	17-19	41281129	59,50€							
50	TC 50	20-22	41281129	59,50€							
50	TC 50 Mini	19-22	41281129	59,50€							
65	CR 65	12-14	41281129	59,50€							
65	TC 65	17-22	41281129	59,50€							
85	TC 85 14/17	16-22	41281087	185,70€	SAKT052	80,90€					
85	TC 85 16/19	14-22	41281087	185,70€	SAKT052	80,90€					
125	CR125	92-95	41281119	144,10€				41271162	207,20€		
125	CR125	96-97	41281119	144,10€							



Cyl	Modèle	Année	JOINT AMORT. HAUT		ROUL. AMORT. HAUT		ROUL. AMORT. BAS		ROUL. AMORT. BAS		ROULETTE DE CHAÎNE			
			€ T.T.C.	ALL BIKES	€ T.T.C.	ALL BIKES	€ T.T.C.	ALL BIKES	€ T.T.C.	FELOM	Supérieure	€ T.T.C.	Inférieure	€ T.T.C.
HONDA														
450	CRF450 RX	19-22	41371126	105,40€	41291013	28,90€	41295008	22,30€	LSAH006	21,90€	41795015	20,90€	41795015	20,90€
450	CRF450 X	05-18	41371126	105,40€	41291013	28,90€	41295008	22,30€	LSAH006	21,90€	41795014	28,80€	41795007	21,40€
450	CRF450 X	19-20	41371126	105,40€	41291013	28,90€	41295008	22,30€	LSAH006	21,90€	41795015	20,90€	41795015	20,90€
450	TRX450 R	04-09			41295019	38,30€	41295019	38,30€						
480	CR480 R	82-83									41795007	21,40€	41795007	21,40€
500	CR500 R	84-84			41291028	35,60€					41795006	21,40€	41795006	21,40€
500	CR500 R	85-85	41371011	97,10€	41291015	24,48€	41291017	56,40€			41795008	20,90€	41795006	21,40€
500	CR500 R	86-86	41371011	97,10€	41291028	35,60€	41291017	56,40€			41795008	20,90€	41795006	21,40€
500	CR500 R	87-87	41371011	97,10€	41291028	35,60€	41291017	56,40€			41795008	20,90€	41795006	21,40€
500	CR500 R	88-88	41371114	97,10€	41291028	35,60€	41291017	56,40€			41795008	20,90€	41795006	21,40€
500	CR500 R	89-90	41371114	97,10€	41291028	35,60€	41295029	51,30€			41795008	20,90€	41795006	21,40€
500	CR500 R	91-92	41371007	52,30€	41291006	49,80€	41295006	25,60€			41795008	20,90€	41795006	21,40€
500	CR500 R	93-93	41371007	52,30€	41291006	49,80€	41295006	25,60€			41795008	20,90€	41795006	21,40€
500	CR500 R	94-94			41291012	29,20€	41295006	25,60€			41795008	20,90€	41795006	21,40€
500	CR500 R	95-95	41371004	52,90€	41291012	29,20€	41295004	51,20€			41795008	20,90€	41795006	21,40€
500	CR500 R	96-01	41371004	52,90€	41291013	28,90€	41295030	51,20€			41795008	20,90€	41795006	21,40€
500	CR500 R	02-02			41291013	28,90€	41295030	51,20€			41795008	20,90€	41795006	21,40€
500	XR500 R	81-81									41795002	21,40€	41795002	21,40€
500	XR500 R	82-82												
500	XR500 R	83-84												
600	XR600 R	85-87			41291018	55,30€	41291018	55,30€						
600	XR600 R	88-90			41291028	35,60€	41291018	55,30€						
600	XR600 R [FR]	91-00			41291028	35,60€	41291018	55,30€						
650	XR650 L [US]	93-13			41291028	35,60€	41291018	55,30€						
650	XR650 R	00-07			41295055	50,80€	41295008	22,30€	LSAH006	21,90€	41795001	21,40€	41795001	21,40€
HUSABERG														
125	TE125 2T	11-16	41371119	114,40€										
250	FE250 4T	13-14			41295059	34,40€	41271089	50,90€	LSAT001	47,90€				
250	TE250 2T	11-14	41371119	114,40€	41295059	34,40€	41271089	50,90€	LSAT001	47,90€				
300	TE300 2T	13-14	41371119	114,40€	41295059	34,40€	41271089	50,90€	LSAT001	47,90€				
350	FE350 4T	13-14	41371119	114,40€										
390	FE390 Enduro	10-12			41295059	34,40€	41271089	50,90€	LSAT001	47,90€				
450	FC450	04-04					41295056	95,80€			41795003	23,00€	41795003	23,00€
450	FC450	05-05					41295056	95,80€			41795003	23,00€	41795003	23,00€
450	FC450	06-06					41295056	95,80€						
450	FE450	09-11			41295059	34,40€	41271089	50,90€	LSAT001	47,90€				
450	FE450	12-12	41371119	114,40€	41295059	34,40€	41271089	50,90€	LSAT001	47,90€				
450	FE450	12-12			41295059	34,40€	41271089	50,90€	LSAT001	47,90€				
450	FE450	13-14	41371119	114,40€	41295059	34,40€	41271089	50,90€	LSAT001	47,90€				
450	FE450 E	04-04					41295056	95,80€			41795003	23,00€	41795003	23,00€
450	FE450 E	05-08					41295056	95,80€			41795003	23,00€	41795003	23,00€
450	FS450 E /C	03-04					41295056	95,80€			41795003	23,00€	41795003	23,00€
450	FS450 E /C	05-08					41295056	95,80€			41795003	23,00€	41795003	23,00€
501	FE501	13-13	41371119	114,40€	41295059	34,40€	41271089	50,90€	LSAT001	47,90€				
501	FE501	14-14	41371119	114,40€	41295059	34,40€	41271089	50,90€	LSAT001	47,90€				
550	FE550 /E	07-08					41295056	95,80€			41795003	23,00€	41795003	23,00€
570	FE570 Enduro	09-12			41295059	34,40€	41271089	50,90€	LSAT001	47,90€				
650	FE650 E	04-04									41795003	23,00€	41795003	23,00€
650	FE650 E	05-08					41295056	95,80€			41795003	23,00€	41795003	23,00€
650	FS650 C /E	04-08									41795003	23,00€	41795003	23,00€
HUSQVARNA														
50	TC 50	17-19					41295070	51,20€						
50	TC 50	20-22			41295070	51,20€	41295070	51,20€						
50	TC 50 Mini	19-22			41295070	51,20€	41295070	51,20€						
65	CR 65	12-14												
65	TC 65	17-22			41295070	51,20€	41295070	51,20€						
85	TC 85 14/17	16-22	41371120	112,20€	41295059	34,40€	41295059	34,40€						
85	TC 85 16/19	14-22	41371120	112,20€	41295059	34,40€	41295059	34,40€						
125	CR125	92-95					41295044	33,20€						
125	CR125	96-97					41295044	33,20€						







Cyl	Modèle	Année	ROULEMENTS DE BRAS OSCILLANT				KIT DE RÉPARATION DE BIELLETES			
				€ T.T.C.		€ T.T.C.		€ T.T.C.		€ T.T.C.
HUSQVARNA										
125	CR125	98-98	41281119	144,10€						
125	CR125	99-01	41281119	144,10€						
125	CR125	02-03	41281119	144,10€				41271133	186,50€	
125	CR125	04-08	41281119	144,10€				41271146	192,20€	
125	CR125	09-09	41281199	128,10€				41271176	112,40€	
125	CR125	10-13	41281199	128,10€				41271176	112,40€	
125	TC125 2T	14-15	41281168	64,80€	SAKT048	80,90€		41271180	111,60€	LRKT031 98,90€
125	TC125 2T	16-20	41281125	63,40€	SAKT049	80,90€		41271180	111,60€	LRKT031 98,90€
125	TC125 2T	21-22	41281125	63,40€	SAKT049	80,90€		41271202	125,50€	LRKT031 98,90€
125	TE125 2T	13-14								
125	TE125 2T	15-16	41281168	64,80€	SAKT048	80,90€		41271180	111,60€	LRKT031 98,90€
125	TX125 2T	17-19								LRKT031 98,90€
125	WR125	96-99	41281119	144,10€				41271162	207,20€	
125	WR125	00-04	41281119	144,10€						
125	WR125	05-08	41281119	144,10€				41271146	192,20€	
125	WR125	09-13	41281199	128,10€				41271176	112,40€	
125	WRE125	94-95	41281119	144,10€				41271162	207,20€	
150	TE150i	20-22	41281168	64,80€	SAKT049	80,90€		41271180	111,60€	LRKT031 98,90€
250	CR250	92-92	41281119	144,10€				41271162	207,20€	
250	CR250	93-95	41281119	144,10€				41271162	207,20€	
250	CR250	96-96	41281119	144,10€				41271162	207,20€	
250	CR250	97-97	41281119	144,10€						
250	CR250	98-01	41281119	144,10€						
250	CR250	02-05	41281119	144,10€				41271133	186,50€	
250	FC 250	14-15	41281168	64,80€	SAKT048	80,90€		41271180	111,60€	LRKT031 98,90€
250	FC 250	16-20	41281168	64,80€	SAKT049	80,90€		41271180	111,60€	LRKT031 98,90€
250	FC 250	21-22	41281168	64,80€	SAKT049	80,90€		41271202	125,50€	LRKT031 98,90€
250	FE250	14-16	41281168	64,80€	SAKT048	80,90€		41271180	111,60€	LRKT031 98,90€
250	FE250	17-22	41281168	64,80€	SAKT049	80,90€		41271180	111,60€	LRKT031 98,90€
250	TC250	02-02	41281119	144,10€				41271151	103,20€	
250	TC250	03-03	41281119	144,10€				41271151	103,20€	
250	TC250	04-04	41281119	144,10€				41271148	190,20€	
250	TC250	05-05	41281119	144,10€				41271147	186,50€	
250	TC250	06-07	41281119	144,10€				41271147	186,50€	
250	TC250	08-11	41281199	128,10€				41271176	112,40€	
250	TC250	12-13	41281199	128,10€				41271176	112,40€	
250	TC250	14-16	41281168	64,80€	SAKT048	80,90€		41271180	111,60€	LRKT031 98,90€
250	TC250	17-20	41281168	64,80€	SAKT049	80,90€		41271180	111,60€	LRKT031 98,90€
250	TC250	21-22	41281168	64,80€	SAKT049	80,90€		41271202	125,50€	LRKT031 98,90€
250	TE250	02-02	41281119	144,10€				41271151	103,20€	
250	TE250	03-03	41281119	144,10€				41271151	103,20€	
250	TE250	04-04	41281119	144,10€				41271148	190,20€	
250	TE250	05-07	41281119	144,10€				41271147	186,50€	
250	TE250	08-11	41281199	128,10€				41271176	112,40€	
250	TE250	12-13	41281199	128,10€				41271176	112,40€	
250	TE250	14-16	41281168	64,80€	SAKT048	80,90€		41271180	111,60€	LRKT031 98,90€
250	TE250	17-17	41281168	64,80€	SAKT049	80,90€		41271180	111,60€	LRKT031 98,90€
250	TE250i	18-22	41281168	64,80€	SAKT049	80,90€		41271180	111,60€	LRKT031 98,90€
250	WR250	96-98	41281119	144,10€				41271162	207,20€	
250	WR250	99-00	41281119	144,10€				41271162	207,20€	
250	WR250	01-01	41281119	144,10€						
250	WR250	02-04	41281119	144,10€				41271133	186,50€	
250	WR250	05-13	41281119	144,10€				41271146	192,20€	
300	TE300	14-16	41281168	64,80€	SAKT048	80,90€		41271180	111,60€	LRKT031 98,90€
300	TE300	17-17	41281125	63,40€	SAKT049	80,90€		41271180	111,60€	LRKT031 98,90€
300	TE300i	18-22	41281125	63,40€	SAKT049	80,90€		41271180	111,60€	LRKT031 98,90€
300	WR300	09-13								
310	TE310	08-10	41281199	128,10€				41271176	112,40€	
310	TE310	11-13	41281199	128,10€				41271176	112,40€	
350	FC 350	14-14	41281168	64,80€	SAKT048	80,90€		41271180	111,60€	LRKT031 98,90€
350	FC 350	15-15	41281168	64,80€	SAKT049	80,90€		41271180	111,60€	LRKT031 98,90€







Cyl	Modèle	Année	JOINT AMORT. HAUT		ROUL. AMORT. HAUT		ROUL. AMORT. BAS		ROUL. AMORT. BAS		ROULETTE DE CHAÎNE				
			€ T.T.C.	ALL RIGHTS RESERVED	€ T.T.C.	ALL RIGHTS RESERVED	€ T.T.C.	ALL RIGHTS RESERVED	€ T.T.C.	FACTORY LINE	€ T.T.C.	Supérieure	€ T.T.C.	Inférieure	€ T.T.C.
HUSQVARNA															
125	CR125	98-98			41295080	81,80€	41295044	33,20€							
125	CR125	99-01			41295080	81,80€	41295044	33,20€				41795001	21,40€	41795001	21,40€
125	CR125	02-03			41295080	81,80€	41295044	33,20€				41795001	21,40€	41795001	21,40€
125	CR125	04-08			41295080	81,80€	41295044	33,20€				41795001	21,40€	41795001	21,40€
125	CR125	09-09			41295080	81,80€	41295062	46,20€				41795001	21,40€	41795001	21,40€
125	CR125	10-13			41295080	81,80€						41795001	21,40€	41795001	21,40€
125	TC125 2T	14-15	41371127	112,20€	41295068	34,70€	41295066	24,90€	LSAT002	24,90€					
125	TC125 2T	16-20	41371127	112,20€	41295068	34,70€	41295066	24,90€	LSAT002	24,90€					
125	TC125 2T	21-22	41371127	112,20€	41295068	34,70€	41295090	29,00€	LSAT002	24,90€					
125	TE125 2T	13-14	41371127	112,20€											
125	TE125 2T	15-16	41371127	112,20€	41295068	34,70€	41295066	24,90€	LSAT002	24,90€					
125	TX125 2T	17-19	41371127	112,20€					LSAT002	24,90€					
125	WR125	96-99			41295080	81,80€						41795001	21,40€	41795001	21,40€
125	WR125	00-04			41295080	81,80€						41795001	21,40€	41795001	21,40€
125	WR125	05-08			41295080	81,80€						41795001	21,40€	41795001	21,40€
125	WR125	09-13			41295080	81,80€						41795001	21,40€	41795001	21,40€
125	WRE125	94-95					41295044	33,20€						41795001	21,40€
150	TE150i	20-22	41371127	112,20€	41295068	34,70€	41295066	24,90€	LSAT002	24,90€					
250	CR250	92-92					41295044	33,20€							
250	CR250	93-95					41295044	33,20€						41795001	21,40€
250	CR250	96-96					41295044	33,20€				41795001	21,40€	41795001	21,40€
250	CR250	97-97					41295044	33,20€				41795001	21,40€	41795001	21,40€
250	CR250	98-01			41295080	81,80€	41295044	33,20€				41795001	21,40€	41795001	21,40€
250	CR250	02-05			41295080	81,80€	41295044	33,20€				41795001	21,40€	41795001	21,40€
250	FC 250	14-15	41371127	112,20€	41295068	34,70€	41295066	24,90€	LSAT002	24,90€					
250	FC 250	16-20	41371127	112,20€	41295068	34,70€	41295066	24,90€	LSAT002	24,90€					
250	FC 250	21-22	41371127	112,20€	41295068	34,70€	41295090	29,00€	LSAT002	24,90€					
250	FE250	14-16	41371127	112,20€	41295068	34,70€	41295066	24,90€	LSAT002	24,90€					
250	FE250	17-22	41371127	112,20€	41295068	34,70€	41295066	24,90€	LSAT002	24,90€					
250	TC250	02-02			41295080	81,80€	41295044	33,20€							
250	TC250	03-03			41295080	81,80€	41295044	33,20€				41795001	21,40€	41795001	21,40€
250	TC250	04-04			41295080	81,80€	41295044	33,20€				41795001	21,40€	41795001	21,40€
250	TC250	05-05			41295080	81,80€	41295044	33,20€				41795001	21,40€	41795001	21,40€
250	TC250	06-07					41295044	33,20€				41795001	21,40€	41795001	21,40€
250	TC250	08-11			41295080	81,80€	41295062	46,20€				41795001	21,40€	41795001	21,40€
250	TC250	12-13					41295062	46,20€				41795001	21,40€	41795001	21,40€
250	TC250	14-16	41371127	112,20€	41295068	34,70€	41295066	24,90€	LSAT002	24,90€					
250	TC250	17-20	41371127	112,20€	41295068	34,70€	41295066	24,90€	LSAT002	24,90€					
250	TC250	21-22	41371127	112,20€	41295068	34,70€	41295090	29,00€	LSAT002	24,90€					
250	TE250	02-02			41295080	81,80€	41295044	33,20€							
250	TE250	03-03			41295080	81,80€	41295044	33,20€				41795001	21,40€	41795001	21,40€
250	TE250	04-04			41295080	81,80€	41295044	33,20€				41795001	21,40€	41795001	21,40€
250	TE250	05-07			41295080	81,80€	41295044	33,20€				41795001	21,40€	41795001	21,40€
250	TE250	08-11			41295080	81,80€	41295062	46,20€				41795001	21,40€	41795001	21,40€
250	TE250	12-13					41295062	46,20€				41795001	21,40€	41795001	21,40€
250	TE250	14-16	41371127	112,20€	41295068	34,70€	41295066	24,90€	LSAT002	24,90€					
250	TE250	17-17	41371127	112,20€	41295068	34,70€	41295066	24,90€	LSAT002	24,90€					
250	TE250i	18-22	41371127	112,20€	41295068	34,70€	41295066	24,90€	LSAT002	24,90€					
250	WR250	96-98					41295044	33,20€				41795001	21,40€	41795001	21,40€
250	WR250	99-00			41295080	81,80€	41295044	33,20€				41795001	21,40€	41795001	21,40€
250	WR250	01-01			41295080	81,80€	41295044	33,20€				41795001	21,40€	41795001	21,40€
250	WR250	02-04			41295080	81,80€	41295044	33,20€				41795001	21,40€	41795001	21,40€
250	WR250	05-13			41295080	81,80€	41295044	33,20€				41795001	21,40€	41795001	21,40€
300	TE300	14-16	41371127	112,20€	41295068	34,70€	41295066	24,90€	LSAT002	24,90€					
300	TE300	17-17	41371127	112,20€	41295068	34,70€	41295066	24,90€	LSAT002	24,90€					
300	TE300i	18-22	41371127	112,20€	41295068	34,70€	41295066	24,90€	LSAT002	24,90€					
300	WR300	09-13										41795001	21,40€	41795001	21,40€
310	TE310	08-10			41295080	81,80€	41295062	46,20€				41795001	21,40€	41795001	21,40€
310	TE310	11-13					41295062	46,20€				41795001	21,40€	41795001	21,40€
350	FC 350	14-14	41371127	112,20€	41295068	34,70€	41295066	24,90€	LSAT002	24,90€					
350	FC 350	15-15	41371127	112,20€	41295068	34,70€	41295066	24,90€	LSAT002	24,90€					







Cyl	Modèle	Année	ROULEMENTS DE BRAS OSCILLANT				KIT DE RÉPARATION DE BIELLETTES			
				€ T.T.C.		€ T.T.C.		€ T.T.C.		€ T.T.C.
HUSQVARNA										
350	FC 350	16-22	41281125	63,40€	SAKT049	80,90€	41271180	111,60€	LRKT031	98,90€
350	FE 350	14-16	41281168	64,80€	SAKT048	80,90€	41271180	111,60€	LRKT031	98,90€
350	FE 350	17-20	41281125	63,40€	SAKT049	80,90€	41271180	111,60€	LRKT031	98,90€
350	FE 350	21-22	41281125	63,40€	SAKT049	80,90€	41271202	125,50€	LRKT031	98,90€
350	TE350	95-99					41271162	207,20€		
360	WR360	96-97	41281119	144,10€			41271162	207,20€		
360	WR360	98-00	41281119	144,10€			41271162	207,20€		
360	WR360	01-01	41281119	144,10€						
360	WR360	02-02	41281119	144,10€			41271133	186,50€		
400	TE400	00-02								
410	TE410	96-98								
410	TE410	99-00								
410	TE410	01-01								
450	FC 450	14-22	41281168	64,80€	SAKT049	80,90€	41271180	111,60€	LRKT031	98,90€
450	FE 450	14-16	41281168	64,80€	SAKT048	80,90€	41271180	111,60€	LRKT031	98,90€
450	FE 450	17-20	41281168	64,80€	SAKT049	80,90€	41271180	111,60€	LRKT031	98,90€
450	FE 450	21-22	41281168	64,80€	SAKT049	80,90€	41271202	125,50€	LRKT031	98,90€
450	FS 450	15-15								
450	FS 450	16-22							LRKT031	98,90€
450	TC450	02-03	41281119	144,10€			41271151	103,20€		
450	TC450	04-04	41281119	144,10€			41271148	190,20€		
450	TC450	05-05	41281119	144,10€			41271147	186,50€		
450	TC450	06-07	41281119	144,10€			41271147	186,50€		
450	TC450	08-10	41281199	128,10€			41271176	112,40€		
450	TC450	11-14	41281199	128,10€			41271176	112,40€		
450	TE450	02-02	41281119	144,10€			41271151	103,20€		
450	TE450	03-03	41281119	144,10€			41271151	103,20€		
450	TE450	04-04	41281119	144,10€			41271148	190,20€		
450	TE450	05-05	41281119	144,10€			41271147	186,50€		
450	TE450	06-07	41281119	144,10€			41271147	186,50€		
450	TE450	08-10	41281199	128,10€			41271176	112,40€		
450	TE450	11-13	41281199	128,10€			41271176	112,40€		
501	FE 501	14-22	41281125	63,40€	SAKT049	80,90€	41271180	111,60€	LRKT031	98,90€
510	SMR510	04-04	41281119	144,10€			41271147	186,50€		
510	SMR510	05-07	41281119	144,10€			41271147	186,50€		
510	SMR510	08-12	41281199	128,10€			41271176	112,40€		
510	TC510	04-04	41281119	144,10€			41271147	186,50€		
510	TC510	05-05	41281119	144,10€			41271147	186,50€		
510	TC510	06-07	41281119	144,10€			41271147	186,50€		
510	TC510	08-09	41281199	128,10€			41271176	112,40€		
510	TC510	10-12	41281199	128,10€			41271176	112,40€		
510	TE510	04-04	41281119	144,10€			41271147	186,50€		
510	TE510	05-07	41281119	144,10€			41271147	186,50€		
510	TE510	08-10	41281199	128,10€			41271176	112,40€		
510	TE510	11-13	41281199	128,10€			41271176	112,40€		
510	TE510 Centennial	04-07	41281119	144,10€			41271147	186,50€		
570	TC570	01-02								
570	TC570	03-04								
570	TE570	01-02								
570	TE570	03-04								
610	TC610	96-97								
610	TC610	98-01								
610	TE610	97-97								
610	TE610	98-98					41271162	207,20€		
610	TE610	99-02								
610	TE610	03-05								
610	TE610	06-07								
610	TE610	08-09								
610	TE610 E	99-01								
630	TE630	10-12								
693	Enduro 701	16-22	41281221	68,10€						







Cyl	Modèle	JOINT AMORT. HAUT		ROUL. AMORT. HAUT		ROUL. AMORT. BAS		ROUL. AMORT. BAS		ROULETTE DE CHAÎNE 			
		Année		€ T.T.C.		€ T.T.C.		€ T.T.C.		€ T.T.C.	Supérieure	€ T.T.C.	Inférieure
HUSQVARNA													
350	FC 350	16-22	41371127	112,20€	41295068	34,70€	41295066	24,90€	LSAT002	24,90€			
350	FE 350	14-16	41371127	112,20€	41295068	34,70€	41295066	24,90€	LSAT002	24,90€			
350	FE 350	17-20	41371127	112,20€	41295068	34,70€	41295066	24,90€	LSAT002	24,90€			
350	FE 350	21-22	41371127	112,20€	41295068	34,70€	41295090	29,00€	LSAT002	24,90€			
350	TE350	95-99					41295044	33,20€					
360	WR360	96-97					41295044	33,20€		41795001	21,40€	41795001	21,40€
360	WR360	98-00			41295080	81,80€	41295044	33,20€		41795001	21,40€	41795001	21,40€
360	WR360	01-01			41295080	81,80€	41295044	33,20€		41795001	21,40€	41795001	21,40€
360	WR360	02-02			41295080	81,80€	41295044	33,20€		41795001	21,40€	41795001	21,40€
400	TE400	00-02	41371124	101,80€									
410	TE410	96-98								41795001	21,40€	41795001	21,40€
410	TE410	99-00			41295080	81,80€				41795001	21,40€	41795001	21,40€
410	TE410	01-01			41295080	81,80€							
450	FC 450	14-22	41371127	112,20€	41295068	34,70€	41295066	24,90€	LSAT002	24,90€			
450	FE 450	14-16	41371127	112,20€	41295068	34,70€	41295066	24,90€	LSAT002	24,90€			
450	FE 450	17-20	41371127	112,20€	41295068	34,70€	41295066	24,90€	LSAT002	24,90€			
450	FE 450	21-22	41371127	112,20€	41295068	34,70€	41295090	29,00€	LSAT002	24,90€			
450	FS 450	15-15	41371127	112,20€									
450	FS 450	16-22	41371127	112,20€					LSAT002	24,90€			
450	TC450	02-03	41371124	101,80€	41295080	81,80€	41295044	33,20€		41795001	21,40€	41795001	21,40€
450	TC450	04-04	41371124	101,80€	41295080	81,80€	41295044	33,20€		41795001	21,40€	41795001	21,40€
450	TC450	05-05	41371124	101,80€			41295044	33,20€		41795001	21,40€	41795001	21,40€
450	TC450	06-07					41295044	33,20€		41795001	21,40€	41795001	21,40€
450	TC450	08-10			41295080	81,80€	41295062	46,20€		41795001	21,40€	41795001	21,40€
450	TC450	11-14			41295080	81,80€	41295062	46,20€					
450	TE450	02-02	41371124	101,80€	41295080	81,80€	41295044	33,20€					
450	TE450	03-03	41371124	101,80€	41295080	81,80€	41295044	33,20€		41795001	21,40€	41795001	21,40€
450	TE450	04-04	41371124	101,80€	41295080	81,80€	41295044	33,20€		41795001	21,40€	41795001	21,40€
450	TE450	05-05	41371124	101,80€	41295080	81,80€	41295044	33,20€		41795001	21,40€	41795001	21,40€
450	TE450	06-07			41295080	81,80€	41295044	33,20€		41795001	21,40€	41795001	21,40€
450	TE450	08-10			41295080	81,80€	41295062	46,20€		41795001	21,40€	41795001	21,40€
450	TE450	11-13			41295080	81,80€	41295062	46,20€					
501	FE 501	14-22	41371127	112,20€	41295068	34,70€	41295066	24,90€	LSAT002	24,90€			
510	SMR510	04-04			41295080	81,80€	41295044	33,20€					
510	SMR510	05-07			41295080	81,80€	41295044	33,20€		41795001	21,40€		
510	SMR510	08-12			41295080	81,80€	41295062	46,20€		41795001	21,40€	41795001	21,40€
510	TC510	04-04			41295080	81,80€	41295044	33,20€					
510	TC510	05-05			41295080	81,80€	41295044	33,20€		41795001	21,40€	41795001	21,40€
510	TC510	06-07					41295044	33,20€		41795001	21,40€	41795001	21,40€
510	TC510	08-09			41295080	81,80€	41295062	46,20€		41795001	21,40€	41795001	21,40€
510	TC510	10-12			41295080	81,80€	41295062	46,20€					
510	TE510	04-04			41295080	81,80€	41295044	33,20€					
510	TE510	05-07			41295080	81,80€	41295044	33,20€		41795001	21,40€	41795001	21,40€
510	TE510	08-10			41295080	81,80€	41295062	46,20€		41795001	21,40€	41795001	21,40€
510	TE510	11-13			41295080	81,80€	41295062	46,20€					
510	TE510 Centennial	04-07			41295080	81,80€	41295044	33,20€					
570	TC570	01-02			41295080	81,80€				41795001	21,40€	41795001	21,40€
570	TC570	03-04			41295080	81,80€							
570	TE570	01-02			41295080	81,80€				41795001	21,40€	41795001	21,40€
570	TE570	03-04			41295080	81,80€							
610	TC610	96-97								41795001	21,40€	41795001	21,40€
610	TC610	98-01			41295080	81,80€				41795001	21,40€	41795001	21,40€
610	TE610	97-97	41371124	101,80€									
610	TE610	98-98	41371124	101,80€	41295080	81,80€							
610	TE610	99-02	41371124	101,80€	41295080	81,80€				41795001	21,40€	41795001	21,40€
610	TE610	03-05	41371124	101,80€	41295080	81,80€							
610	TE610	06-07	41371124	101,80€	41295080	81,80€				41795001	21,40€	41795001	21,40€
610	TE610	08-09	41371124	101,80€	41295080	81,80€							
610	TE610 E	99-01								41795001	21,40€	41795001	21,40€
630	TE630	10-12	41371124	101,80€									
693	Enduro 701	16-22					41295068	34,70€					







Cyl	Modèle	Année	ROULEMENTS DE BRAS OSCILLANT				KIT DE RÉPARATION DE BIELLETES			
				€ T.T.C.		€ T.T.C.		€ T.T.C.		€ T.T.C.
KAWASAKI										
60	KX60	83-99	41281067	62,20€						
65	KX65	00-01	41281067	62,20€			41271012	106,84€		
65	KX65	02-17	41281067	62,20€			41271011	112,30€		
65	KX65	18-22	41281067	62,20€			41271011	112,30€		
80	KX80	89-90	41281067	62,20€						
80	KX80	91-96	41281067	62,20€			41271013	196,80€		
80	KX80	97-97	41281067	62,20€			41271013	196,80€		
80	KX80	98-00	41281067	62,20€			41271014	112,80€		
85	KX85	01-22	41281067	62,20€			41271014	112,80€		
110	KLX110	02-21	41281173	49,84€	SAKK185	74,90€				
125	KX125	82-82	41281081	57,00€						
125	KX125	83-83	41281080	58,70€						
125	KX125	84-84	41281082	57,00€						
125	KX125	85-85	41281079	60,53€			41271105	108,82€		
125	KX125	86-86	41281080	58,70€			41271107	103,20€		
125	KX125	87-87	41281080	58,70€			41271070	106,84€		
125	KX125	88-88	41281080	58,70€			41271108	103,20€		
125	KX125	89-91	41281080	58,70€			41271040	114,00€		
125	KX125	92-92	41281066	119,00€			41271040	114,00€		
125	KX125	93-93	41281066	119,00€			41271038	196,80€		
125	KX125	94-96	41281065	121,30€			41271036	112,80€		
125	KX125	97-97	41281043	81,92€			41271036	112,80€		
125	KX125	98-98	41281042	81,92€			41271037	112,80€		
125	KX125	99-99	41281044	83,50€	SAKK179	74,90€	41271018	114,00€		
125	KX125	00-03	41281044	83,50€	SAKK179	74,90€	41271018	114,00€		
125	KX125	04-08	41281044	83,50€	SAKK179	74,90€	41271117	112,80€	LRKK105	94,90€
200	KDX200	92-94	41281080	58,70€			41271040	114,00€		
200	KDX200	95-06	41281064	57,00€			41271036	112,80€		
250	KDX250	91-94								
250	KDX250	95-97								
250	KLX250 R	93-93	41281080	58,70€			41271138	106,84€		
250	KLX250 R	94-98	41281080	58,70€			41271123	190,10€		
250	KLX250 S /SF	09-17	41281080	58,70€			41271123	190,10€		
250	KX250	82-82	41281081	57,00€						
250	KX250	83-83	41281080	58,70€						
250	KX250	84-84	41281082	57,00€						
250	KX250	85-85	41281079	60,53€						
250	KX250	86-86	41281080	58,70€						
250	KX250	87-87	41281080	58,70€			41271070	106,84€		
250	KX250	88-88	41281080	58,70€			41271108	103,20€		
250	KX250	89-91	41281080	58,70€			41271040	114,00€		
250	KX250	92-92	41281056	68,10€			41271040	114,00€		
250	KX250	93-93	41281056	68,10€			41271038	196,80€		
250	KX250	94-95	41281065	121,30€			41271036	112,80€		
250	KX250	96-97	41281043	81,92€			41271036	112,80€		
250	KX250	98-98	41281042	81,92€			41271037	112,80€		
250	KX250	99-99	41281044	83,50€	SAKK179	74,90€	41271018	114,00€		
250	KX250	00-03	41281044	83,50€	SAKK179	74,90€	41271018	114,00€		
250	KX250	04-08	41281044	83,50€	SAKK179	74,90€	41271117	112,80€	LRKK105	94,90€
250	KX250 F	04-05	41281115	160,90€	SAKK185	74,90€	41271117	112,80€	LRKK105	94,90€
250	KX250 F	06-06	41281156	164,20€	SAKK186	74,90€	41271137	112,80€	LRKK107	94,90€
250	KX250 F	07-16	41281156	164,20€	SAKK186	74,90€	41271137	112,80€	LRKK107	94,90€
250	KX250 F	17-18	41281217	179,80€	SAKK190	74,90€	41271137	112,80€	LRKK107	94,90€
250	KX250 F - KX	19-20	41281217	179,80€	SAKK190	74,90€	41271137	112,80€	LRKK107	94,90€
250	KX250 F - KX	21-22	41281217	179,80€	SAKK190	74,90€				
250	KX250X Enduro (KL)	22-22	41281217	179,80€	SAKK190	74,90€				
300	KEF300 Lakota	95-03	41281080	58,70€						
300	KLX300 R	97-07	41281080	58,70€			41271123	190,10€		
360	KVF360 Prairie 2x4	03-07	41281080	58,70€			41271123	190,10€		
360	KVF360 Prairie 2x4	08-09	41281059	76,90€						



Cyl	Modèle	Année	JOINT AMORT. HAUT		ROUL. AMORT. HAUT		ROUL. AMORT. BAS		ROUL. AMORT. BAS		ROULETTE DE CHAÎNE 			
				€ T.T.C.		€ T.T.C.		€ T.T.C.		€ T.T.C.	Supérieure	€ T.T.C.	Inférieure	€ T.T.C.
KAWASAKI														
60	KX60	83-99												
65	KX65	00-01	41371005	101,10€			41295022	18,80€	LSAK002	18,90€	41795012	17,10€	41795009	10,90€
65	KX65	02-17	41371005	101,10€			41295022	18,80€	LSAK002	18,90€	41795012	17,10€	41795009	10,90€
65	KX65	18-22	41371005	101,10€			41295022	18,80€			41795012	17,10€	41795009	10,90€
80	KX80	89-90	41371012	99,10€							41795009	10,90€	41795009	10,90€
80	KX80	91-96	41371012	99,10€			41291002	24,90€			41795009	10,90€	41795009	10,90€
80	KX80	97-97	41371012	99,10€	41291002	24,90€	41291002	24,90€			41795009	10,90€	41795009	10,90€
80	KX80	98-00	41371012	99,10€	41291002	24,90€	41295022	18,80€			41795009	10,90€	41795009	10,90€
85	KX85	01-22	41371012	99,10€	41291002	24,90€	41295022	18,80€	LSAK002	18,90€	41795012	17,10€	41795012	17,10€
110	KLX110	02-21												
125	KX125	82-82									41795002	21,40€	41795002	21,40€
125	KX125	83-83									41795002	21,40€	41795002	21,40€
125	KX125	84-84					41295040	26,80€			41795001	21,40€	41795001	21,40€
125	KX125	85-85					41295040	26,80€			41795001	21,40€	41795001	21,40€
125	KX125	86-86	41371010	97,10€			41295040	26,80€			41795001	21,40€	41795001	21,40€
125	KX125	87-87	41371007	52,30€			41295040	26,80€			41795001	21,40€	41795001	21,40€
125	KX125	88-88	41371003	99,10€			41295041	24,48€			41795001	21,40€	41795001	21,40€
125	KX125	89-91	41371003	99,10€	41291002	24,90€	41291002	24,90€			41795001	21,40€	41795001	21,40€
125	KX125	92-92	41371003	99,10€	41291002	24,90€	41291002	24,90€			41795001	21,40€	41795001	21,40€
125	KX125	93-93	41371002	52,30€	41291002	24,90€	41291002	24,90€			41795001	21,40€	41795001	21,40€
125	KX125	94-96	41371002	52,30€	41291002	24,90€	41291002	24,90€			41795001	21,40€	41795001	21,40€
125	KX125	97-97	41371002	52,30€	41291002	24,90€	41291002	24,90€			41795001	21,40€	41795001	21,40€
125	KX125	98-98	41371002	52,30€	41291002	24,90€	41295022	18,80€	LSAK002	18,90€	41795001	21,40€	41795001	21,40€
125	KX125	99-99	41371002	52,30€	41291002	24,90€	41295022	18,80€	LSAK002	18,90€	41795001	21,40€	41795001	21,40€
125	KX125	00-03	41371004	52,90€	41291002	24,90€	41295022	18,80€	LSAK002	18,90€	41795001	21,40€	41795001	21,40€
125	KX125	04-08	41371004	52,90€	41291002	24,90€	41295022	18,80€	LSAK002	18,90€	41795001	21,40€	41795001	21,40€
200	KDX200	92-94	41371007	52,30€			41291002	24,90€			41795001	21,40€	41795001	21,40€
200	KDX200	95-06	41371007	52,30€			41291002	24,90€			41795001	21,40€	41795001	21,40€
250	KDX250	91-94	41371007	52,30€							41795001	21,40€	41795001	21,40€
250	KDX250	95-97	41371007	52,30€										
250	KLX250 R	93-93	41371007	52,30€			41291002	24,90€					41795001	21,40€
250	KLX250 R	94-98	41371007	52,30€			41291002	24,90€					41795001	21,40€
250	KLX250 S /SF	09-17					41291002	24,90€					41795001	21,40€
250	KX250	82-82									41795002	21,40€	41795002	21,40€
250	KX250	83-83											41795002	21,40€
250	KX250	84-84					41295040	26,80€			41795001	21,40€	41795001	21,40€
250	KX250	85-85					41295040	26,80€			41795001	21,40€	41795001	21,40€
250	KX250	86-86					41295040	26,80€			41795001	21,40€	41795001	21,40€
250	KX250	87-87	41371007	52,30€			41295040	26,80€			41795001	21,40€	41795001	21,40€
250	KX250	88-88	41371003	99,10€			41295041	24,48€			41795001	21,40€	41795001	21,40€
250	KX250	89-91	41371003	99,10€	41291002	24,90€	41291002	24,90€			41795001	21,40€	41795001	21,40€
250	KX250	92-92	41371003	99,10€	41291002	24,90€	41291002	24,90€			41795001	21,40€	41795001	21,40€
250	KX250	93-93	41371002	52,30€	41291002	24,90€	41291002	24,90€			41795001	21,40€	41795001	21,40€
250	KX250	94-95	41371002	52,30€	41291002	24,90€	41291002	24,90€			41795001	21,40€	41795001	21,40€
250	KX250	96-97	41371002	52,30€	41291002	24,90€	41291002	24,90€			41795001	21,40€	41795001	21,40€
250	KX250	98-98	41371002	52,30€	41291002	24,90€	41295022	18,80€	LSAK002	18,90€	41795001	21,40€	41795001	21,40€
250	KX250	99-99	41371002	52,30€	41291002	24,90€	41295022	18,80€	LSAK002	18,90€	41795001	21,40€	41795001	21,40€
250	KX250	00-03	41371004	52,90€	41291002	24,90€	41295022	18,80€	LSAK002	18,90€	41795001	21,40€	41795001	21,40€
250	KX250	04-08	41371004	52,90€	41291002	24,90€	41295022	18,80€	LSAK002	18,90€	41795001	21,40€	41795001	21,40€
250	KX250 F	04-05	41371004	52,90€	41291002	24,90€	41295022	18,80€	LSAK002	18,90€	41795001	21,40€	41795001	21,40€
250	KX250 F	06-06	41371126	105,40€	41291002	24,90€	41295022	18,80€	LSAK002	18,90€	41795001	21,40€	41795001	21,40€
250	KX250 F	07-16	41371126	105,40€	41291002	24,90€	41295022	18,80€	LSAK002	18,90€	41795014	28,80€	41795014	28,80€
250	KX250 F	17-18	41371126	105,40€	41291002	24,90€	41295022	18,80€	LSAK002	18,90€	41795014	28,80€	41795014	28,80€
250	KX250 F - KX	19-20	41371126	105,40€	41291002	24,90€	41295022	18,80€	LSAK002	18,90€	41795014	28,80€	41795014	28,80€
250	KX250 F - KX	21-22	41371001	52,30€	41291002	24,90€	41295022	18,80€	LSAK002	18,90€	41795016	25,20€	41795014	28,80€
250	KX250X Enduro (KL)	22-22	41371001	52,30€	41291002	24,90€	41295022	18,80€	LSAK002	18,90€	41795016	25,20€	41795014	28,80€
300	KEF300 Lakota	95-03												
300	KLX300 R	97-07	41371007	52,30€			41291002	24,90€					41795001	21,40€
360	KVF360 Prairie 2x4	03-07	41371007	52,30€			41291002	24,90€					41795001	21,40€
360	KVF360 Prairie 2x4	08-09												







Cyl	Modèle	Année	ROULEMENTS DE BRAS OSCILLANT				KIT DE RÉPARATION DE BIELLETTES			
				€ T.T.C.		€ T.T.C.		€ T.T.C.		€ T.T.C.
KAWASAKI										
360	KVF360 Prairie 4x4	03-13	41281059	76,90€						
400	KVF400 Prairie	98-98	41281059	76,90€						
400	KVF400 Prairie 2x4	99-02	41281059	76,90€						
400	KVF400 Prairie 4x4	99-02	41281059	76,90€						
450	KLX450 R	05-07	41281156	164,20€				41271137	112,80€	LRKK107 94,90€
450	KLX450 R	08-09	41281156	164,20€	SAKK186	74,90€		41271137	112,80€	LRKK107 94,90€
450	KLX450 R	10-15	41281156	164,20€				41271137	112,80€	LRKK107 94,90€
450	KX450 F	06-06	41281156	164,20€	SAKK186	74,90€		41271137	112,80€	LRKK107 94,90€
450	KX450 F	07-08	41281156	164,20€	SAKK186	74,90€		41271137	112,80€	LRKK107 94,90€
450	KX450 F	09-15	41281156	164,20€	SAKK186	74,90€		41271137	112,80€	LRKK107 94,90€
450	KX450 F	16-16	41281216	179,80€				41271137	112,80€	LRKK107 94,90€
450	KX450 F	17-18	41281217	179,80€	SAKK190	74,90€		41271137	112,80€	LRKK107 94,90€
450	KX450 F - KX	19-22	41281217	179,80€	SAKK190	74,90€		41271194	111,60€	
450	KX450 X Enduro (KL)	22-22	41281217	179,80€				41271194	111,60€	
500	KX500	84-84	41281082	57,00€						
500	KX500	85-85	41281079	60,53€				41271106	108,82€	
500	KX500	86-86	41281080	58,70€				41271106	108,82€	
500	KX500	87-87	41281080	58,70€				41271070	106,84€	
500	KX500	88-88	41281080	58,70€				41271108	103,20€	
500	KX500	89-93	41281080	58,70€				41271040	114,00€	
500	KX500	94-04	41281080	58,70€				41271040	114,00€	
650	KLX650 C	93-95	41281065	121,30€						
650	KLX650 R	93-96	41281065	121,30€						
650	KLX650 R	99-01	41281065	121,30€						
650	KVF650 Brute Force 4x4i	06-14	41281059	76,90€						
700	KFX700 V-Force	04-09	41281059	76,90€						
KTM										
0	SX-E	19-22	41281129	59,50€						
50	Mini Adventure 50	98-07	41281169	40,90€						
50	Supermoto 50 SM	06-06	41281070	69,68€						
50	SX50	06-09	41281170	126,30€						
50	SX50	10-22	41281129	59,50€						
50	SX50 Junior	06-06	41281169	40,90€						
50	SX50 Junior	07-08	41281169	40,90€						
50	SX50 Junior	09-15	41281129	59,50€						
50	SX50 Mini	19-22	41281129	59,50€						
50	SX50 Pro Junior	97-01	41281169	40,90€						
50	SX50 Pro Junior LC	02-05	41281169	40,90€						
50	SX50 Pro Junior LC	06-06	41281129	59,50€						
50	SX50 Pro Senior	97-01	41281169	40,90€						
50	SX50 Pro Senior LC	02-03	41281169	40,90€						
50	SX50 Pro Senior LC	04-06	41281170	126,30€						
50	SX50 Senior Adventure	03-07	41281170	126,30€						
60	SX60	98-99	41281129	59,50€						
60	SX60	00-01	41281129	59,50€						
65	SX65	00-01	41281129	59,50€						
65	SX65	02-08	41281129	59,50€						
65	SX65	09-14	41281129	59,50€						
65	SX65	15-22	41281129	59,50€						
85	SX85	03-03	41281087	185,70€	SAKT052	80,90€				
85	SX85	04-22	41281087	185,70€	SAKT052	80,90€				
125	EGS125	93-97	41281087	185,70€	SAKT047	80,90€		41271130	196,80€	
125	EGS125	98-98	41281088	90,50€						
125	EGS125	99-99	41281088	90,50€						
125	EXC125 Enduro	95-97	41281087	185,70€	SAKT047	80,90€		41271130	196,80€	
125	EXC125 Enduro	98-98	41281088	90,50€						
125	EXC125 Enduro	99-99	41281088	90,50€						
125	EXC125 Enduro	00-01	41281088	90,50€	SAKT046	80,90€				
125	EXC125 Enduro	02-03	41281088	90,50€						
125	EXC125 Enduro	04-04	41281168	64,80€	SAKT048	80,90€				



Cyl	Modèle	Année	JOINT AMORT. HAUT		ROUL. AMORT. HAUT		ROUL. AMORT. BAS		ROUL. AMORT. BAS		ROULETTE DE CHAÎNE			
			€ T.T.C.	ALL BIPIES	€ T.T.C.	ALL BIPIES	€ T.T.C.	ALL BIPIES	€ T.T.C.	ALL BIPIES	Supérieure	€ T.T.C.	Inférieure	€ T.T.C.
KAWASAKI														
360	KVF360 Prairie 4x4	03-13												
400	KVF400 Prairie	98-98												
400	KVF400 Prairie 2x4	99-02												
400	KVF400 Prairie 4x4	99-02												
450	KLX450 R	05-07	41371004	52,90€	41291002	24,90€	41295022	18,80€			41795014	28,80€	41795014	28,80€
450	KLX450 R	08-09	41371004	52,90€	41291002	24,90€	41295022	18,80€	LSAK002	18,90€	41795014	28,80€	41795014	28,80€
450	KLX450 R	10-15	41371004	52,90€	41291002	24,90€	41295022	18,80€			41795014	28,80€	41795014	28,80€
450	KX450 F	06-06	41371004	52,90€	41291002	24,90€	41295022	18,80€	LSAK002	18,90€	41795001	21,40€	41795001	21,40€
450	KX450 F	07-08	41371004	52,90€	41291002	24,90€	41295022	18,80€	LSAK002	18,90€	41795014	28,80€	41795014	28,80€
450	KX450 F	09-15	41371001	52,30€	41291002	24,90€	41295022	18,80€	LSAK002	18,90€	41795014	28,80€	41795014	28,80€
450	KX450 F	16-16	41371001	52,30€	41291002	24,90€	41295022	18,80€	LSAK002	18,90€	41795014	28,80€	41795014	28,80€
450	KX450 F	17-18	41371126	105,40€	41291002	24,90€	41295022	18,80€	LSAK002	18,90€	41795014	28,80€	41795014	28,80€
450	KX450 F - KX	19-22	41371126	105,40€	41291002	24,90€	41295022	18,80€			41795016	25,20€	41795014	28,80€
450	KX450 X Enduro (KL)	22-22	41371126	105,40€	41291002	24,90€	41295022	18,80€			41795016	25,20€	41795014	28,80€
500	KX500	84-84	41371010	97,10€			41295040	26,80€			41795001	21,40€	41795001	21,40€
500	KX500	85-85	41371010	97,10€			41295040	26,80€			41795001	21,40€	41795001	21,40€
500	KX500	86-86	41371002	52,30€			41295040	26,80€			41795001	21,40€	41795001	21,40€
500	KX500	87-87	41371007	52,30€			41295040	26,80€			41795001	21,40€	41795001	21,40€
500	KX500	88-88	41371003	99,10€			41295041	24,48€			41795001	21,40€	41795001	21,40€
500	KX500	89-93	41371003	99,10€	41291002	24,90€	41291002	24,90€			41795001	21,40€	41795001	21,40€
500	KX500	94-04	41371002	52,30€	41291002	24,90€	41291002	24,90€			41795001	21,40€	41795001	21,40€
650	KLX650 C	93-95	41371007	52,30€			41291002	24,90€						
650	KLX650 R	93-96	41371007	52,30€			41291002	24,90€						
650	KLX650 R	99-01					41291002	24,90€						
650	KVF650 Brute Force 4x4i	06-14												
700	KFX700 V-Force	04-09												
KTM														
0	SX-E	19-22			41295070	51,20€	41295070	51,20€						
50	Mini Adventure 50	98-07												
50	Supermoto 50 SM	06-06												
50	SX50	06-09			41295070	51,20€	41295070	51,20€						
50	SX50	10-22			41295070	51,20€	41295070	51,20€						
50	SX50 Junior	06-06			41295070	51,20€	41295070	51,20€						
50	SX50 Junior	07-08			41295067	48,50€	41295067	48,50€						
50	SX50 Junior	09-15			41295067	48,50€	41295067	48,50€						
50	SX50 Mini	19-22			41295070	51,20€	41295070	51,20€						
50	SX50 Pro Junior	97-01												
50	SX50 Pro Junior LC	02-05			41295070	51,20€	41295070	51,20€						
50	SX50 Pro Junior LC	06-06			41295070	51,20€	41295070	51,20€						
50	SX50 Pro Senior	97-01												
50	SX50 Pro Senior LC	02-03			41295070	51,20€	41295070	51,20€						
50	SX50 Pro Senior LC	04-06			41295070	51,20€	41295070	51,20€						
50	SX50 Senior Adventure	03-07			41295070	51,20€	41295070	51,20€						
60	SX60	98-99			41295070	51,20€	41295070	51,20€						
60	SX60	00-01												
65	SX65	00-01												
65	SX65	02-08			41295070	51,20€	41295070	51,20€						
65	SX65	09-14			41295071	51,20€	41295071	51,20€						
65	SX65	15-22			41295070	51,20€	41295070	51,20€						
85	SX85	03-03	41371120	112,20€										
85	SX85	04-22	41371120	112,20€	41295059	34,40€	41295059	34,40€						
125	EGS125	93-97					41291024	59,70€			41795003	23,00€	41795003	23,00€
125	EGS125	98-98					41291089				41795003	23,00€	41795003	23,00€
125	EGS125	99-99	41371119	114,40€			41291089				41795003	23,00€	41795003	23,00€
125	EXC125 Enduro	95-97					41291024	59,70€			41795003	23,00€	41795003	23,00€
125	EXC125 Enduro	98-98			41295059	34,40€	41291089		LSAT001	47,90€	41795003	23,00€	41795003	23,00€
125	EXC125 Enduro	99-99	41371119	114,40€	41295059	34,40€	41291089		LSAT001	47,90€	41795003	23,00€	41795003	23,00€
125	EXC125 Enduro	00-01	41371119	114,40€	41295059	34,40€	41291089		LSAT001	47,90€	41795003	23,00€	41795003	23,00€
125	EXC125 Enduro	02-03	41371119	114,40€	41295059	34,40€	41291089		LSAT001	47,90€	41795003	23,00€	41795003	23,00€
125	EXC125 Enduro	04-04	41371119	114,40€	41295029	51,30€	41291089		LSAT001	47,90€	41795003	23,00€	41795003	23,00€







Cyl	Modèle	Année	ROULEMENTS DE BRAS OSCILLANT				KIT DE RÉPARATION DE BIELLETTES			
				€ T.T.C.		€ T.T.C.		€ T.T.C.		€ T.T.C.
KTM										
125	EXC125 Enduro	05-05	41281168	64,80€	SAKT048	80,90€				
125	EXC125 Enduro	06-08	41281168	64,80€	SAKT048	80,90€				
125	EXC125 Enduro	09-09	41281168	64,80€	SAKT048	80,90€				
125	EXC125 Enduro	10-16			SAKT048	80,90€				
125	EXC125 Enduro	17-17			SAKT048	80,90€				
125	SX125	93-97	41281087	185,70€	SAKT047	80,90€	41271130	196,80€		
125	SX125	98-98	41281088	90,50€	SAKT046	80,90€				
125	SX125	99-03	41281088	90,50€	SAKT046	80,90€				
125	SX125	04-05	41281168	64,80€	SAKT048	80,90€				
125	SX125	06-07	41281168	64,80€	SAKT048	80,90€				
125	SX125	08-11	41281168	64,80€	SAKT048	80,90€				
125	SX125	12-15	41281168	64,80€	SAKT048	80,90€	41271180	111,60€	LRKT031	98,90€
125	SX125	16-20	41281125	63,40€	SAKT049	80,90€	41271180	111,60€	LRKT031	98,90€
125	SX125	21-22	41281125	63,40€	SAKT049	80,90€	41271202	125,50€	LRKT031	98,90€
125	XC125 W Enduro	19-19	41281125	63,40€	SAKT049	80,90€				
150	EXC150 TPI Enduro	20-22	41281125	63,40€	SAKT049	80,90€				
150	SX144	07-08	41281168	64,80€	SAKT048	80,90€				
150	SX150	09-11	41281168	64,80€	SAKT048	80,90€				
150	SX150	12-15	41281168	64,80€	SAKT048	80,90€	41271180	111,60€	LRKT031	98,90€
150	SX150	16-20	41281125	63,40€	SAKT049	80,90€	41271180	111,60€	LRKT031	98,90€
150	SX150	21-22	41281125	63,40€	SAKT049	80,90€	41271202	125,50€	LRKT031	98,90€
200	EGS200	98-98	41281088	90,50€						
200	EGS200	99-99	41281088	90,50€						
200	EXC200 Enduro	98-98	41281088	90,50€	SAKT046	80,90€				
200	EXC200 Enduro	99-03	41281088	90,50€	SAKT046	80,90€				
200	EXC200 Enduro	04-05	41281168	64,80€	SAKT048	80,90€				
200	EXC200 Enduro	06-16			SAKT048	80,90€				
200	SX200	00-00	41281088	90,50€	SAKT046	80,90€				
200	SX200	01-03	41281088	90,50€	SAKT046	80,90€				
200	SX200	04-04	41281168	64,80€	SAKT048	80,90€				
200	SX200	05-06	41281168	64,80€	SAKT048	80,90€				
250	EGS250	94-94	41281087	185,70€	SAKT047	80,90€	41271130	196,80€		
250	EGS250	95-95	41281087	185,70€	SAKT047	80,90€	41271130	196,80€		
250	EGS250	96-97	41281088	90,50€			41271130	196,80€		
250	EGS250	98-98	41281088	90,50€						
250	EGS250	99-99	41281088	90,50€						
250	EXC250 Enduro	95-97	41281088	90,50€			41271130	196,80€		
250	EXC250 Enduro	98-98	41281088	90,50€						
250	EXC250 Enduro	99-02	41281088	90,50€						
250	EXC250 Enduro	03-03	41281088	90,50€						
250	EXC250 Enduro	04-05	41281168	64,80€	SAKT048	80,90€				
250	EXC250 Enduro	06-11	41281168	64,80€	SAKT048	80,90€				
250	EXC250 Enduro	12-12	41281168	64,80€	SAKT048	80,90€				
250	EXC250 Enduro	13-16	41281168	64,80€	SAKT048	80,90€				
250	EXC250 Enduro	17-17	41281125	63,40€	SAKT049	80,90€				
250	EXC250 Racing	02-03			SAKT046	80,90€				
250	EXC250 Racing	04-05	41281168	64,80€	SAKT048	80,90€				
250	EXC250 Racing	06-15	41281168	64,80€	SAKT048	80,90€				
250	EXC250 TPI Enduro	18-22	41281125	63,40€	SAKT049	80,90€				
250	EXC250-F Enduro	07-10	41281168	64,80€	SAKT048	80,90€				
250	EXC250-F Enduro	11-15	41281168	64,80€	SAKT048	80,90€				
250	EXC250-F Enduro	16-16	41281125	63,40€	SAKT049	80,90€				
250	EXC250-F Enduro	17-22	41281125	63,40€	SAKT049	80,90€				
250	Freeride	13-17	41281087	185,70€	SAKT047	80,90€				
250	Freeride F	18-20	41281087	185,70€	SAKT047	80,90€				
250	MX250	94-94	41281087	185,70€	SAKT047	80,90€	41271130	196,80€		
250	SX250	95-95	41281087	185,70€	SAKT047	80,90€	41271130	196,80€		
250	SX250	96-97	41281088	90,50€			41271130	196,80€		
250	SX250	98-98	41281088	90,50€						
250	SX250	99-01	41281088	90,50€						







Cyl	Modèle	Année	JOINT AMORT. HAUT		ROUL. AMORT. HAUT		ROUL. AMORT. BAS		ROUL. AMORT. BAS		ROULETTE DE CHAÎNE			
			€ T.T.C.	ALL BALLS	€ T.T.C.	ALL BALLS	€ T.T.C.	ALL BALLS	€ T.T.C.	ALL BALLS	Supérieure	€ T.T.C.	Inférieure	€ T.T.C.
KTM														
125	EXC125 Enduro	05-05	41371119	114,40€	41295059	34,40€	41291089		LSAT001	47,90€	41795003	23,00€	41795003	23,00€
125	EXC125 Enduro	06-08	41371119	114,40€	41295059	34,40€	41291089		LSAT001	47,90€			41795003	23,00€
125	EXC125 Enduro	09-09	41371119	114,40€	41295059	34,40€	41291089		LSAT001	47,90€				
125	EXC125 Enduro	10-16							LSAT001	47,90€				
125	EXC125 Enduro	17-17												
125	SX125	93-97					41291024	59,70€			41795003	23,00€	41795003	23,00€
125	SX125	98-98			41295059	34,40€	41271089	50,90€	LSAT001	47,90€	41795003	23,00€	41795003	23,00€
125	SX125	99-03	41371119	114,40€	41295059	34,40€	41271089	50,90€	LSAT001	47,90€	41795003	23,00€	41795003	23,00€
125	SX125	04-05	41371119	114,40€	41295059	34,40€	41271089	50,90€	LSAT001	47,90€	41795003	23,00€	41795003	23,00€
125	SX125	06-07	41371119	114,40€	41295059	34,40€	41271089	50,90€	LSAT001	47,90€			41795003	23,00€
125	SX125	08-11	41371119	114,40€	41295059	34,40€	41271089	50,90€	LSAT001	47,90€				
125	SX125	12-15	41371127	112,20€	41295068	34,70€	41295066	24,90€	LSAT002	24,90€				
125	SX125	16-20	41371127	112,20€	41295068	34,70€	41295066	24,90€	LSAT002	24,90€				
125	SX125	21-22	41371127	112,20€	41295068	34,70€	41275090	29,00€	LSAT002	24,90€				
125	XC125 W Enduro	19-19	41371120	112,20€	41295059	34,40€	41295077	43,20€						
150	EXC150 TPI Enduro	20-22	41371119	114,40€	41295059	34,40€	41295077	43,20€						
150	SX144	07-08	41371127	112,20€	41295059	34,40€	41271089	50,90€	LSAT001	47,90€				
150	SX150	09-11	41371127	112,20€	41295059	34,40€	41271089	50,90€	LSAT001	47,90€				
150	SX150	12-15	41371127	112,20€	41295068	34,70€	41295066	24,90€	LSAT002	24,90€				
150	SX150	16-20	41371127	112,20€	41295068	34,70€	41295066	24,90€	LSAT002	24,90€				
150	SX150	21-22	41371127	112,20€	41295068	34,70€	41275090	29,00€	LSAT002	24,90€				
200	EGS200	98-98			41295059	34,40€	41271089	50,90€	LSAT001	47,90€	41795003	23,00€	41795003	23,00€
200	EGS200	99-99	41371119	114,40€	41295059	34,40€	41271089	50,90€	LSAT001	47,90€	41795003	23,00€	41795003	23,00€
200	EXC200 Enduro	98-98			41295059	34,40€	41271089	50,90€	LSAT001	47,90€	41795003	23,00€	41795003	23,00€
200	EXC200 Enduro	99-03	41371119	114,40€	41295059	34,40€	41271089	50,90€	LSAT001	47,90€	41795003	23,00€	41795003	23,00€
200	EXC200 Enduro	04-05	41371119	114,40€	41295059	34,40€	41271089	50,90€	LSAT001	47,90€	41795003	23,00€	41795003	23,00€
200	EXC200 Enduro	06-16	41371119	114,40€					LSAT001	47,90€				
200	SX200	00-00	41371119	114,40€					LSAT001	47,90€	41795003	23,00€	41795003	23,00€
200	SX200	01-03	41371119	114,40€	41295059	34,40€	41271089	50,90€	LSAT001	47,90€	41795003	23,00€	41795003	23,00€
200	SX200	04-04	41371119	114,40€	41295059	34,40€	41271089	50,90€	LSAT001	47,90€	41795003	23,00€	41795003	23,00€
200	SX200	05-06			41295059	34,40€	41271089	50,90€	LSAT001	47,90€				
250	EGS250	94-94									41795003	23,00€	41795003	23,00€
250	EGS250	95-95					41291024	59,70€			41795003	23,00€	41795003	23,00€
250	EGS250	96-97					41291024	59,70€			41795003	23,00€	41795003	23,00€
250	EGS250	98-98									41795003	23,00€	41795003	23,00€
250	EGS250	99-99	41371119	114,40€							41795003	23,00€	41795003	23,00€
250	EXC250 Enduro	95-97					41291024	59,70€			41795003	23,00€	41795003	23,00€
250	EXC250 Enduro	98-98			41295059	34,40€	41271089	50,90€	LSAT001	47,90€	41795003	23,00€	41795003	23,00€
250	EXC250 Enduro	99-02	41371119	114,40€	41295059	34,40€	41271089	50,90€	LSAT001	47,90€	41795003	23,00€	41795003	23,00€
250	EXC250 Enduro	03-03	41371119	114,40€	41295059	34,40€	41271089	50,90€	LSAT001	47,90€			41795003	23,00€
250	EXC250 Enduro	04-05	41371119	114,40€	41295059	34,40€	41271089	50,90€	LSAT001	47,90€			41795003	23,00€
250	EXC250 Enduro	06-11	41371119	114,40€	41295059	34,40€	41271089	50,90€	LSAT001	47,90€				
250	EXC250 Enduro	12-12	41371127	112,20€	41295068	34,70€	41271089	50,90€	LSAT001	47,90€				
250	EXC250 Enduro	13-16	41371127	112,20€	41295068	34,70€	41271089	50,90€	LSAT002	24,90€				
250	EXC250 Enduro	17-17	41371127	112,20€	41295068	34,70€	41295077	43,20€	LSAT002	24,90€				
250	EXC250 Racing	02-03							LSAT001	47,90€				
250	EXC250 Racing	04-05	41371119	114,40€	41295059	34,40€	41271089	50,90€	LSAT001	47,90€			41795003	23,00€
250	EXC250 Racing	06-15	41371119	114,40€	41295059	34,40€	41271089	50,90€	LSAT001	47,90€				
250	EXC250 TPI Enduro	18-22	41371120	112,20€	41295059	34,40€	41295077	43,20€						
250	EXC250-F Enduro	07-10	41371119	114,40€	41295059	34,40€	41271089	50,90€	LSAT001	47,90€				
250	EXC250-F Enduro	11-15	41371119	114,40€	41295068	34,70€	41271089	50,90€	LSAT002	24,90€				
250	EXC250-F Enduro	16-16	41371119	114,40€	41295068	34,70€	41271089	50,90€	LSAT002	24,90€				
250	EXC250-F Enduro	17-22	41371120	112,20€	41295059	34,40€	41295077	43,20€						
250	Freeride	13-17	41371120	112,20€	41295059	34,40€	41295059	34,40€						
250	Freeride F	18-20	41371120	112,20€	41295059	34,40€	41295059	34,40€						
250	MX250	94-94			41295068	34,70€	41291024	59,70€						
250	SX250	95-95					41291024	59,70€					41795003	23,00€
250	SX250	96-97					41291024	59,70€			41795003	23,00€	41795003	23,00€
250	SX250	98-98					41271089	50,90€	LSAT001	47,90€	41795003	23,00€	41795003	23,00€
250	SX250	99-01	41371119	114,40€			41271089	50,90€	LSAT001	47,90€	41795003	23,00€	41795003	23,00€







Cyl	Modèle	Année	ROULEMENTS DE BRAS OSCILLANT				KIT DE RÉPARATION DE BIELLETTES			
				€ T.T.C.		€ T.T.C.		€ T.T.C.		€ T.T.C.
KTM										
250	SX250	02-02	41281088	90,50€						
250	SX250	03-03	41281168	64,80€	SAKT048	80,90€				
250	SX250 2T	04-11	41281168	64,80€	SAKT048	80,90€				
250	SX250 2T	12-16	41281168	64,80€	SAKT048	80,90€	41271180	111,60€	LRKT031	98,90€
250	SX250 2T	17-22	41281125	63,40€	SAKT049	80,90€	41271180	111,60€	LRKT031	98,90€
250	SX250-F	05-09	41281168	64,80€	SAKT048	80,90€				
250	SX250-F	10-10	41281168	64,80€	SAKT048	80,90€				
250	SX250-F	11-11	41281168	64,80€	SAKT048	80,90€	41271180	111,60€	LRKT031	98,90€
250	SX250-F	12-15	41281158	85,60€	SAKT048	80,90€	41271180	111,60€	LRKT031	98,90€
250	SX250-F	16-20	41281125	63,40€	SAKT049	80,90€	41271180	111,60€	LRKT031	98,90€
250	SX250-F	21-22	41281125	63,40€	SAKT049	80,90€	41271202	125,50€	LRKT031	98,90€
300	EGS300	94-95	41281087	185,70€	SAKT047	80,90€	41271130	196,80€		
300	EGS300	96-97	41281088	90,50€			41271130	196,80€		
300	EGS300	98-98	41281088	90,50€						
300	EGS300	99-99	41281088	90,50€						
300	EXC300 Enduro	94-95	41281087	185,70€	SAKT047	80,90€	41271130	196,80€		
300	EXC300 Enduro	96-97	41281088	90,50€	SAKT046	80,90€	41271130	196,80€		
300	EXC300 Enduro	98-98	41281088	90,50€	SAKT046	80,90€				
300	EXC300 Enduro	99-02	41281088	90,50€	SAKT046	80,90€				
300	EXC300 Enduro	03-03	41281088	90,50€	SAKT046	80,90€				
300	EXC300 Enduro	04-05	41281168	64,80€	SAKT048	80,90€				
300	EXC300 Enduro	06-11	41281168	64,80€	SAKT048	80,90€				
300	EXC300 Enduro	12-12	41281168	64,80€	SAKT048	80,90€				
300	EXC300 Enduro	13-16	41281168	64,80€	SAKT048	80,90€				
300	EXC300 Enduro	17-17	41281125	63,40€	SAKT049	80,90€				
300	EXC300 TPI Enduro	18-22	41281125	63,40€	SAKT049	80,90€				
300	SX300	94-94			SAKT047	80,90€				
300	SX300	95-95			SAKT046	80,90€				
350	EXC350-F	12-16	41281168	64,80€	SAKT048	80,90€				
350	EXC350-F	17-17	41281125	63,40€	SAKT049	80,90€				
350	EXC350-F	18-22	41281125	63,40€	SAKT049	80,90€				
350	Freeride 350	12-17	41281087	185,70€	SAKT047	80,90€				
350	SX350-F	11-15	41281168	64,80€	SAKT048	80,90€	41271180	111,60€	LRKT031	98,90€
350	SX350-F	16-20	41281125	63,40€	SAKT049	80,90€	41271180	111,60€	LRKT031	98,90€
350	SX350-F	21-22	41281125	63,40€	SAKT049	80,90€	41271202	125,50€	LRKT031	98,90€
360	EGS360	96-97	41281088	90,50€			41271130	196,80€		
360	EXC360	96-97	41281088	90,50€			41271130	196,80€		
360	SX360	96-98	41281088	90,50€			41271130	196,80€		
380	EGS380	98-99	41281088	90,50€						
380	EXC380	98-02	41281088	90,50€	SAKT046	80,90€				
380	SX380	98-02	41281088	90,50€	SAKT046	80,90€				
380	XC380	98-99			SAKT046	80,90€				
400	EGS400 LC4	94-96	41281087	185,70€	SAKT047	80,90€				
400	EGS400 LC4	97-97	41281087	185,70€	SAKT047	80,90€				
400	EGS400 LC4	98-98	41281087	185,70€	SAKT047	80,90€				
400	EGS400 LC4 LSE	97-98	41281087	185,70€	SAKT047	80,90€				
400	EGS400 LC4-E	99-99	41281087	185,70€	SAKT047	80,90€				
400	EGS400 LC4-E 2T	00-01	41281087	185,70€	SAKT047	80,90€				
400	EGS400 LC4-E 4T	01-01	41281087	185,70€	SAKT047	80,90€				
400	EXC400	00-02	41281087	185,70€	SAKT047	80,90€				
400	EXC400	03-14								
400	MXC400	01-02			SAKT047	80,90€				
400	SX400 Enduro	00-02	41281087	185,70€	SAKT047	80,90€				
400	SX400 Racing (> 04/2002)	00-02	41281087	185,70€	SAKT047	80,90€				
400	SXC400 Tiainen Replica	99-00	41281087	185,70€	SAKT047	80,90€				
450	EXC450-F	03-03	41281087	185,70€	SAKT047	80,90€				
450	EXC450-F	04-04	41281087	185,70€	SAKT047	80,90€				
450	EXC450-F	05-11	41281125	63,40€	SAKT049	80,90€				
450	EXC450-F	12-12	41281125	63,40€	SAKT049	80,90€				
450	EXC450-F	13-16	41281168	64,80€	SAKT048	80,90€				







Cyl	Modèle	Année	JOINT AMORT. HAUT		ROUL. AMORT. HAUT		ROUL. AMORT. BAS		ROUL. AMORT. BAS		ROULETTE DE CHAÎNE 			
				€ T.T.C.		€ T.T.C.		€ T.T.C.		€ T.T.C.	Supérieure	€ T.T.C.	Inférieure	€ T.T.C.
KTM														
250	SX250	02-02	41371119	114,40€	41295059	34,40€	41271089	50,90€	LSAT001	47,90€	41795003	23,00€	41795003	23,00€
250	SX250	03-03	41371119	114,40€	41295059	34,40€	41271089	50,90€	LSAT001	47,90€			41795003	23,00€
250	SX250 2T	04-11	41371119	114,40€	41295059	34,40€	41271089	50,90€	LSAT001	47,90€			41795003	23,00€
250	SX250 2T	12-16	41371127	112,20€	41295068	34,70€	41295066	24,90€	LSAT002	24,90€				
250	SX250 2T	17-22	41371127	112,20€	41295068	34,70€	41295066	24,90€	LSAT002	24,90€				
250	SX250-F	05-09	41371119	114,40€	41295059	34,40€	41271089	50,90€	LSAT001	47,90€			41795003	23,00€
250	SX250-F	10-10	41371127	112,20€	41295059	34,40€	41271089	50,90€	LSAT001	47,90€			41795003	23,00€
250	SX250-F	11-11	41371127	112,20€	41295059	34,40€	41295066	24,90€	LSAT002	24,90€				
250	SX250-F	12-15	41371127	112,20€	41295068	34,70€	41295066	24,90€	LSAT002	24,90€				
250	SX250-F	16-20	41371127	112,20€	41295068	34,70€	41295066	24,90€	LSAT002	24,90€				
250	SX250-F	21-22	41371127	112,20€	41295068	34,70€	41295090	29,00€	LSAT002	24,90€				
300	EGS300	94-95					41291024	59,70€			41795003	23,00€	41795003	23,00€
300	EGS300	96-97					41291024	59,70€			41795003	23,00€	41795003	23,00€
300	EGS300	98-98									41795003	23,00€	41795003	23,00€
300	EGS300	99-99	41371119	114,40€							41795003	23,00€	41795003	23,00€
300	EXC300 Enduro	94-95					41291024	59,70€			41795003	23,00€	41795003	23,00€
300	EXC300 Enduro	96-97					41291024	59,70€			41795003	23,00€	41795003	23,00€
300	EXC300 Enduro	98-98			41295059	34,40€	41271089	50,90€	LSAT001	47,90€	41795003	23,00€	41795003	23,00€
300	EXC300 Enduro	99-02	41371119	114,40€	41295059	34,40€	41271089	50,90€	LSAT001	47,90€	41795003	23,00€	41795003	23,00€
300	EXC300 Enduro	03-03	41371119	114,40€	41295059	34,40€	41271089	50,90€	LSAT001	47,90€			41795003	23,00€
300	EXC300 Enduro	04-05	41371119	114,40€	41295059	34,40€	41271089	50,90€	LSAT001	47,90€			41795003	23,00€
300	EXC300 Enduro	06-11	41371119	114,40€	41295059	34,40€	41271089	50,90€	LSAT001	47,90€			41795003	23,00€
300	EXC300 Enduro	12-12	41371119	114,40€	41295068	34,70€	41271089	50,90€	LSAT001	47,90€				
300	EXC300 Enduro	13-16	41371119	114,40€	41295068	34,70€	41271089	50,90€	LSAT002	24,90€				
300	EXC300 Enduro	17-17	41371120	112,20€	41295068	34,70€	41295077	43,20€	LSAT002	24,90€				
300	EXC300 TPI Enduro	18-22	41371120	112,20€	41295059	34,40€	41295077	43,20€						
300	SX300	94-94												
300	SX300	95-95												
350	EXC350-F	12-16	41371119	114,40€	41295059	34,40€	41271089	50,90€	LSAT001	47,90€				
350	EXC350-F	17-17	41371120	112,20€	41295059	34,40€	41295077	43,20€	LSAT001	47,90€				
350	EXC350-F	18-22	41371120	112,20€	41295059	34,40€	41295077	43,20€						
350	Freeride 350	12-17	41371120	112,20€	41295059	34,40€	41295059	34,40€						
350	SX350-F	11-15	41371127	112,20€	41295068	34,70€	41295066	24,90€	LSAT002	24,90€				
350	SX350-F	16-20	41371127	112,20€	41295068	34,70€	41295066	24,90€	LSAT002	24,90€				
350	SX350-F	21-22	41371127	112,20€	41295068	34,70€	41295090	29,00€	LSAT002	24,90€				
360	EGS360	96-97					41291024	59,70€			41795003	23,00€	41795003	23,00€
360	EXC360	96-97					41291024	59,70€			41795003	23,00€	41795003	23,00€
360	SX360	96-98					41291024	59,70€			41795003	23,00€	41795003	23,00€
380	EGS380	98-99	41371119	114,40€	41295059	34,40€	41271089	50,90€	LSAT001	47,90€	41795003	23,00€	41795003	23,00€
380	EXC380	98-02	41371119	114,40€	41295059	34,40€	41271089	50,90€	LSAT001	47,90€	41795003	23,00€	41795003	23,00€
380	SX380	98-02			41295059	34,40€	41271089	50,90€	LSAT001	47,90€	41795003	23,00€	41795003	23,00€
380	XC380	98-99							LSAT001	47,90€				
400	EGS400 LC4	94-96			41295068	34,70€					41795003	23,00€	41795003	23,00€
400	EGS400 LC4	97-97									41795003	23,00€	41795003	23,00€
400	EGS400 LC4	98-98												
400	EGS400 LC4 LSE	97-98												
400	EGS400 LC4-E	99-99												
400	EGS400 LC4-E 2T	00-01			41295059	34,40€	41271089	50,90€	LSAT001	47,90€				
400	EGS400 LC4-E 4T	01-01			41295059	34,40€	41271089	50,90€	LSAT001	47,90€				
400	EXC400	00-02	41371119	114,40€	41295059	34,40€	41271089	50,90€	LSAT001	47,90€	41795003	23,00€	41795003	23,00€
400	EXC400	03-14	41371119	114,40€										
400	MXC400	01-02							LSAT001	47,90€	41795003	23,00€	41795003	23,00€
400	SX400 Enduro	00-02							LSAT001	47,90€	41795003	23,00€	41795003	23,00€
400	SX400 Racing (> 04/2002)	00-02									41795003	23,00€	41795003	23,00€
400	SXC400 Tlainen Replica	99-00												
450	EXC450-F	03-03	41371119	114,40€	41295059	34,40€	41271089	50,90€	LSAT001	47,90€			41795003	23,00€
450	EXC450-F	04-04	41371119	114,40€	41295059	34,40€	41271089	50,90€	LSAT001	47,90€				
450	EXC450-F	05-11	41371119	114,40€	41295059	34,40€	41271089	50,90€	LSAT001	47,90€				
450	EXC450-F	12-12	41371119	114,40€	41295059	34,40€	41271089	50,90€	LSAT001	47,90€				
450	EXC450-F	13-16	41371127	112,20€	41295059	34,40€	41271089	50,90€	LSAT001	47,90€				







Cyl	Modèle	Année	ROULEMENTS DE BRAS OSCILLANT				KIT DE RÉPARATION DE BIELLETTES			
				€ T.T.C.		€ T.T.C.		€ T.T.C.		€ T.T.C.
KTM										
450	EXC450-F	17-17	41281125	63,40€	SAKT049	80,90€				
450	EXC450-F	18-22	41281125	63,40€	SAKT049	80,90€				
450	EXC450-R	02-02								
450	EXC450-R	03-03			SAKT047	80,90€				
450	EXC450-R	04-08			SAKT049	80,90€				
450	EXC450-R	09-09	41281125	63,40€	SAKT049	80,90€				
450	EXC450-R	10-16	41281125	63,40€	SAKT049	80,90€				
450	MXC450	03-03	41281087	185,70€	SAKT047	80,90€				
450	MXC450	04-05	41281125	63,40€	SAKT049	80,90€				
450	SMR450	04-07	41281125	63,40€	SAKT049	80,90€				
450	SMR450	08-12	41281168	64,80€	SAKT048	80,90€				
450	SMR450	13-14	41281125	63,40€	SAKT049	80,90€				
450	SMR450	21-21	41281125	63,40€	SAKT049	80,90€	41271202	125,50€	LRKT031	98,90€
450	SX450 ATV	08-08	41281168	64,80€						
450	SX450 ATV	09-13	41281168	64,80€						
450	SX450 Racing	03-03	41281087	185,70€	SAKT047	80,90€				
450	SX450 Racing	04-06	41281125	63,40€	SAKT049	80,90€				
450	SX450 Racing	15-15	41281125	63,40€	SAKT049	80,90€	41271180	111,60€	LRKT031	98,90€
450	SX450-F	03-03			SAKT047	80,90€				
450	SX450-F	04-06								
450	SX450-F	07-07	41281168	64,80€	SAKT048	80,90€				
450	SX450-F	08-10	41281168	64,80€	SAKT048	80,90€				
450	SX450-F	11-11	41281168	64,80€	SAKT048	80,90€	41271180	111,60€	LRKT031	98,90€
450	SX450-F	12-12	41281168	64,80€	SAKT048	80,90€	41271180	111,60€	LRKT031	98,90€
450	SX450-F	13-16	41281125	63,40€	SAKT049	80,90€	41271180	111,60€	LRKT031	98,90€
450	SX450-F	17-20	41281125	63,40€	SAKT049	80,90€	41271180	111,60€	LRKT031	98,90€
450	SX450-F	21-22	41281125	63,40€	SAKT049	80,90€	41271202	125,50€	LRKT031	98,90€
450	XC450 ATV	08-13	41281168	64,80€						
450	XC450-F	08-08	41281168	64,80€	SAKT048	80,90€	41271180	111,60€	LRKT031	98,90€
450	XC450-F	09-09	41281168	64,80€	SAKT048	80,90€	41271180	111,60€	LRKT031	98,90€
450	XC450-F	10-12			SAKT048	80,90€				
450	XC450-F	13-13			SAKT048	80,90€			LRKT031	98,90€
450	XC450-W /WR	08-13	41281125	63,40€						
500	EXC500-F	12-16	41281125	63,40€	SAKT049	80,90€				
500	EXC500-F	17-22	41281125	63,40€	SAKT049	80,90€				
505	SX505 ATV	08-08	41281168	64,80€						
505	SX505 ATV	09-09	41281168	64,80€						
505	SX505 ATV	10-13	41281168	64,80€						
505	SX505 F Racing	07-09	41281168	64,80€	SAKT048	80,90€				
505	SX505 F Racing	10-11								
505	SX505 F Racing (US)	07-11								
505	XC505 ATV	08-08	41281168	64,80€						
505	XC505 ATV	09-09	41281168	64,80€						
505	XC505 ATV	10-13	41281168	64,80€						
505	XC505-F	09-09			SAKT048	80,90€				
505	XC505-F	10-11								
520	EXC520 Racing 4T (> 04/2002)	01-02								
520	EXC520 Racing 4T (05/2002 >)	02-02			SAKT047	80,90€				
520	MXC520 2T	01-02								
520	MXC520 4T	01-02								
520	SX520 Racing 4T (> 04/2002)	01-02	41281087	185,70€	SAKT047	80,90€				
520	SX520 Racing 4T (05/2002 >)	02-02	41281087	185,70€	SAKT047	80,90€				
525	EXC525 Racing 4T	03-03	41281087	185,70€	SAKT047	80,90€				
525	EXC525 Racing 4T	03-07	41281087	185,70€	SAKT047	80,90€				
525	MXC525 4T	03-03			SAKT047	80,90€				
525	MXC525 4T	04-06			SAKT049	80,90€				
525	SX525 Racing 2T	03-03								
525	SX525 Racing 4T	03-03	41281087	185,70€	SAKT047	80,90€				
525	SX525 Racing 4T	04-08	41281125	63,40€	SAKT049	80,90€				
525	XC525 ATV	08-13	41281168	64,80€						







Cyl	Modèle	Année	JOINT AMORT. HAUT		ROUL. AMORT. HAUT		ROUL. AMORT. BAS		ROUL. AMORT. BAS		ROULETTE DE CHAÎNE 			
				€ T.T.C.		€ T.T.C.		€ T.T.C.		€ T.T.C.	Supérieure	€ T.T.C.	Inférieure	€ T.T.C.
KTM														
450	EXC450-F	17-17	41371127	112,20€	41295059	34,40€	41295077	43,20€						
450	EXC450-F	18-22	41371120	112,20€	41295059	34,40€	41295077	43,20€						
450	EXC450-R	02-02	41371119	114,40€										
450	EXC450-R	03-03	41371119	114,40€					LSAT001	47,90€				
450	EXC450-R	04-08	41371119	114,40€					LSAT001	47,90€				
450	EXC450-R	09-09	41371119	114,40€	41295059	34,40€			LSAT001	47,90€				
450	EXC450-R	10-16	41371119	114,40€	41295059	34,40€								
450	MXC450	03-03	41371119	114,40€	41295059	34,40€			LSAT001	47,90€		41795003	23,00€	
450	MXC450	04-05	41371119	114,40€	41295059	34,40€			LSAT001	47,90€		41795003	23,00€	
450	SMR450	04-07	41371119	114,40€	41295059	34,40€			LSAT001	47,90€		41795003	23,00€	
450	SMR450	08-12	41371119	114,40€	41295059	34,40€			LSAT001	47,90€		41795003	23,00€	
450	SMR450	13-14	41371119	114,40€	41295059	34,40€			LSAT001	47,90€		41795003	23,00€	
450	SMR450	21-21	41371127	112,20€	41295068	34,70€	41295090	29,00€	LSAT002	24,90€				
450	SX450 ATV	08-08												
450	SX450 ATV	09-13			41295059	34,40€								
450	SX450 Racing	03-03	41371119	114,40€	41295059	34,40€	41271089	50,90€	LSAT001	47,90€				
450	SX450 Racing	04-06	41371119	114,40€	41295059	34,40€	41271089	50,90€	LSAT001	47,90€				
450	SX450 Racing	15-15	41371119	114,40€	41295059	34,40€	41295066	24,90€	LSAT002	24,90€				
450	SX450-F	03-03	41371119	114,40€					LSAT001	47,90€				
450	SX450-F	04-06	41371119	114,40€					LSAT001	47,90€				
450	SX450-F	07-07	41371119	114,40€	41295059	34,40€			LSAT001	47,90€		41795003	23,00€	
450	SX450-F	08-10	41371119	114,40€	41295059	34,40€			LSAT001	47,90€				
450	SX450-F	11-11	41371119	114,40€	41295059	34,40€	41295066	24,90€	LSAT002	24,90€				
450	SX450-F	12-12	41371127	112,20€	41295059	34,40€	41295066	24,90€	LSAT002	24,90€				
450	SX450-F	13-16	41371127	112,20€	41295059	34,40€	41295066	24,90€	LSAT002	24,90€				
450	SX450-F	17-20	41371127	112,20€	41295068	34,70€	41295066	24,90€	LSAT002	24,90€				
450	SX450-F	21-22	41371127	112,20€	41295068	34,70€	41295090	29,00€	LSAT002	24,90€				
450	XC450 ATV	08-13												
450	XC450-F	08-08	41371119	114,40€	41295059	34,40€	41271089	50,90€	LSAT001	47,90€				
450	XC450-F	09-09			41295059	34,40€	41271089	50,90€	LSAT001	47,90€				
450	XC450-F	10-12							LSAT001	47,90€				
450	XC450-F	13-13							LSAT002	24,90€				
450	XC450-W /WR	08-13	41371119	114,40€										
500	EXC500-F	12-16	41371119	114,40€	41295059	34,40€	41271089	50,90€	LSAT001	47,90€				
500	EXC500-F	17-22	41371120	112,20€	41295059	34,40€	41295077	43,20€						
505	SX505 ATV	08-08												
505	SX505 ATV	09-09			41295059	34,40€	41295059	34,40€						
505	SX505 ATV	10-13												
505	SX505 F Racing	07-09	41371119	114,40€	41295059	34,40€	41271089	50,90€	LSAT001	47,90€				
505	SX505 F Racing	10-11	41371119	114,40€					LSAT001	47,90€				
505	SX505 F Racing (US)	07-11	41371119	114,40€										
505	XC505 ATV	08-08												
505	XC505 ATV	09-09			41295059	34,40€	41295059	34,40€						
505	XC505 ATV	10-13												
505	XC505-F	09-09							LSAT001	47,90€				
505	XC505-F	10-11							LSAT001	47,90€				
520	EXC520 Racing 4T (> 04/2002)	01-02									41795003	23,00€	41795003	23,00€
520	EXC520 Racing 4T (05/2002 >)	02-02							LSAT001	47,90€	41795003	23,00€	41795003	23,00€
520	MXC520 2T	01-02									41795003	23,00€	41795003	23,00€
520	MXC520 4T	01-02									41795003	23,00€	41795003	23,00€
520	SX520 Racing 4T (> 04/2002)	01-02			41295059	34,40€	41271089	50,90€	LSAT001	47,90€	41795003	23,00€	41795003	23,00€
520	SX520 Racing 4T (05/2002 >)	02-02			41295059	34,40€	41271089	50,90€	LSAT001	47,90€	41795003	23,00€	41795003	23,00€
525	EXC525 Racing 4T	03-03	41371119	114,40€	41295059	34,40€	41271089	50,90€	LSAT001	47,90€			41795003	23,00€
525	EXC525 Racing 4T	03-07	41371119	114,40€	41295059	34,40€	41271089	50,90€	LSAT001	47,90€	41795003	23,00€	41795003	23,00€
525	MXC525 4T	03-03							LSAT001	47,90€	41795003	23,00€		
525	MXC525 4T	04-06							LSAT001	47,90€	41795003	23,00€		
525	SX525 Racing 2T	03-03											41795003	23,00€
525	SX525 Racing 4T	03-03			41295059	34,40€	41271089	50,90€	LSAT001	47,90€			41795003	23,00€
525	SX525 Racing 4T	04-08			41295059	34,40€	41271089	50,90€	LSAT001	47,90€			41795003	23,00€
525	XC525 ATV	08-13												







Cyl	Modèle	Année	ROULEMENTS DE BRAS OSCILLANT				KIT DE RÉPARATION DE BIELLETES			
				€ T.T.C.		€ T.T.C.		€ T.T.C.		€ T.T.C.
KTM										
530	EXC530	08-11	41281125	63,40€	SAKT049	80,90€				
550	MXC550	93-96								
560	SMR560	06-07								
620	EXC620 LC4	94-95	41281087	185,70€	SAKT047	80,90€				
620	EXC620 LC4	96-99	41281087	185,70€	SAKT047	80,90€				
620	SC620	96-02	41281087	185,70€	SAKT047	80,90€				
620	SX620 LC4	94-99	41281087	185,70€	SAKT047	80,90€				
620	SXC620 LC4	00-02	41281087	185,70€	SAKT047	80,90€				
690	Enduro 690	08-15	41281221	68,10€						
690	Enduro 690 R	09-21	41281221	68,10€						
MONTESA										
250	Cota 315R 250	97-00	41281190	113,60€						
250	Cota 4RT 250	05-07	41281190	113,60€			41271166	207,20€		
POLARIS										
200	Phoenix 200	05-14	41281056	68,10€						
Rieju										
250	MR250	22-22	41281223	167,60€	SAKG020	88,90€	41271195	197,20€	LRKG021	98,90€
300	MR300	21-22	41281223	167,60€	SAKG020	88,90€	41271195	197,20€	LRKG021	98,90€
300	MR300 Ranger	22-22	41281223	167,60€	SAKG020	88,90€				
SHERCO										
50	Enduro 50	06-13								
50	SE 0.5 50	09-16								
80	Sherco 0.8 80	03-08	41281191	113,60€			41271165	211,30€		
125	SE 125-R	18-19	41281196	68,10€	SAKC001	62,90€	41271199	203,90€	LRKC002	98,90€
125	SE 125-R	20-20	41281196	68,10€	SAKC001	62,90€	41271199	203,90€	LRKC002	98,90€
125	SE 125-R	21-22	41281196	68,10€	SAKC001	62,90€				
125	ST 1.25 125	09-10	41281191	113,60€			41271198	111,70€		
125	ST 1.25 125	11-17	41281191	113,60€			41271198	111,70€		
125	ST 125	18-22	41281191	113,60€			41271198	111,70€		
125	TY 125 Classic	19-21	41281191	113,60€						
125	X-Ride 125	11-19	41281191	113,60€						
200	Sherco 2.0 200	03-06	41281191	113,60€			41271165	211,30€		
250	Enduro 2.5 i 250	05-07	41281196	68,10€	SAKC001	62,90€	41271189	215,80€	LRKC001	98,90€
250	Enduro 2.5 i 250	08-08	41281196	68,10€	SAKC001	62,90€	41271189	215,80€	LRKC001	98,90€
250	Enduro 2.5 i 250	09-11	41281196	68,10€	SAKC001	62,90€	41271189	215,80€	LRKC001	98,90€
250	SC250	19-19	41281196	68,10€	SAKC001	62,90€	41271199	203,90€	LRKC002	98,90€
250	SCF250	19-19	41281196	68,10€	SAKC001	62,90€	41271199	203,90€	LRKC002	98,90€
250	SE 2.5i-F 250	09-13	41281196	68,10€	SAKC001	62,90€	41271189	215,80€	LRKC001	98,90€
250	SE-R 250	14-16	41281196	68,10€	SAKC001	62,90€	41271189	215,80€	LRKC001	98,90€
250	SE-R 250	17-19	41281196	68,10€	SAKC001	62,90€	41271199	203,90€	LRKC002	98,90€
250	SE-R 250	20-20	41281196	68,10€	SAKC001	62,90€	41271199	203,90€	LRKC002	98,90€
250	SE-R 250	21-22	41281196	68,10€	SAKC001	62,90€	41271199	203,90€	LRKC002	98,90€
250	SE-R 250 Factory	14-16	41281196	68,10€	SAKC001	62,90€	41271189	215,80€	LRKC001	98,90€
250	SE-R 250 Factory	17-17	41281196	68,10€	SAKC001	62,90€	41271199	203,90€	LRKC002	98,90€
250	SE-R 250 Factory	18-18	41281196	68,10€	SAKC001	62,90€	41271199	203,90€	LRKC002	98,90€
250	SE-R 250 Factory	19-19	41281196	68,10€	SAKC001	62,90€	41271199	203,90€	LRKC002	98,90€
250	SE-R 250 Factory	20-21	41281196	68,10€	SAKC001	62,90€				
250	SE-R 250 Factory	22-22	41281196	68,10€	SAKC001	62,90€				
250	SEF-R 2,5 250 4T	14-16	41281196	68,10€	SAKC001	62,90€	41271189	215,80€	LRKC001	98,90€
250	SEF-R 2,5 250 4T	17-19	41281196	68,10€	SAKC001	62,90€	41271199	203,90€	LRKC002	98,90€
250	SEF-R 2,5 250 4T	20-20	41281196	68,10€	SAKC001	62,90€	41271199	203,90€	LRKC002	98,90€
250	SEF-R 2,5 250 4T	21-22	41281196	68,10€	SAKC001	62,90€	41271199	203,90€	LRKC002	98,90€
250	SEF-R 2,5 250 4T Factory	14-16	41281196	68,10€	SAKC001	62,90€	41271189	215,80€	LRKC001	98,90€
250	SEF-R 2,5 250 4T Factory	17-19	41281196	68,10€	SAKC001	62,90€	41271199	203,90€	LRKC002	98,90€
250	SEF-R 2,5 250 4T Factory	20-20	41281196	68,10€	SAKC001	62,90€				
250	SEF-R 2,5 250 4T Factory	21-22	41281196	68,10€	SAKC001	62,90€				
250	Sherco 2.5 250	98-08	41281191	113,60€			41271165	211,30€		
250	Sherco 2.5 250	13-14	41281191	113,60€			41271198	111,70€		
250	ST 2.5 250	09-09	41281191	113,60€			41271198	111,70€		
250	ST 2.5 250	10-10	41281191	113,60€			41271165	211,30€		
250	ST 2.5 250	11-17	41281191	113,60€			41271198	111,70€		



Cyl	Modèle	Année	JOINT AMORT. HAUT		ROUL. AMORT. HAUT		ROUL. AMORT. BAS		ROUL. AMORT. BAS		ROULETTE DE CHAÎNE 			
				€ T.T.C.		€ T.T.C.		€ T.T.C.		€ T.T.C.	Supérieure	€ T.T.C.	Inférieure	€ T.T.C.
KTM														
530	EXC530	08-11	41371119	114,40€	41295059	34,40€	41271089	50,90€	LSAT001	47,90€				
550	MXC550	93-96									41795003	23,00€	41795003	23,00€
560	SMR560	06-07											41795003	23,00€
620	EXC620 LC4	94-95									41795003	23,00€	41795003	23,00€
620	EXC620 LC4	96-99												
620	SC620	96-02												
620	SX620 LC4	94-99												
620	SXC620 LC4	00-02												
690	Enduro 690	08-15	41371120	112,20€			41295068	34,70€						
690	Enduro 690 R	09-21	41371120	112,20€			41295068	34,70€						
MONTESA														
250	Cota 315R 250	97-00												
250	Cota 4RT 250	05-07												
POLARIS														
200	Phoenix 200	05-14												
	Rieju													
250	MR250	22-22			41291016	28,90€	41295015	23,30€	LSAY002	21,90€				
300	MR300	21-22			41291016	28,90€	41295015	23,30€	LSAY002	21,90€				
300	MR300 Ranger	22-22												
SHERCO														
50	Enduro 50	06-13									41795003	23,00€		
50	SE 0.5 50	09-16									41795003	23,00€		
80	Sherco 0.8 80	03-08					41295065	48,80€						
125	SE 125-R	18-19	41371120	112,20€			41295088	24,10€	LSAC002	24,90€				
125	SE 125-R	20-20	41371120	112,20€										
125	SE 125-R	21-22												
125	ST 1.25 125	09-10					41295065	48,80€						
125	ST 1.25 125	11-17			41295065	48,80€	41295065	48,80€						
125	ST 125	18-22			41295065	48,80€	41295065	48,80€						
125	TY 125 Classic	19-21												
125	X-Ride 125	11-19												
200	Sherco 2.0 200	03-06					41295065	48,80€						
250	Enduro 2.5 i 250	05-07					41295082	22,50€	LSAC001	24,90€				
250	Enduro 2.5 i 250	08-08					41295082	22,50€	LSAC001	24,90€	41795003	23,00€	41795003	23,00€
250	Enduro 2.5 i 250	09-11					41295082	22,50€	LSAC001	24,90€				
250	SC250	19-19			41291016	28,90€	41295088	24,10€	LSAC002	24,90€				
250	SCF250	19-19			41291016	28,90€	41295088	24,10€	LSAC002	24,90€				
250	SE 2.5i-F 250	09-13					41295082	22,50€	LSAC001	24,90€	41795003	23,00€	41795003	23,00€
250	SE-R 250	14-16					41295082	22,50€	LSAC001	24,90€	41795003	23,00€	41795003	23,00€
250	SE-R 250	17-19	41371120	112,20€			41295088	24,10€	LSAC002	24,90€	41795003	23,00€	41795003	23,00€
250	SE-R 250	20-20	41371120	112,20€			41295088	24,10€	LSAC002	24,90€	41795003	23,00€	41795003	23,00€
250	SE-R 250	21-22					41295088	24,10€			41795003	23,00€	41795003	23,00€
250	SE-R 250 Factory	14-16					41295082	22,50€	LSAC001	24,90€	41795003	23,00€	41795003	23,00€
250	SE-R 250 Factory	17-17					41295088	24,10€	LSAC002	24,90€	41795003	23,00€	41795003	23,00€
250	SE-R 250 Factory	18-18	41371120	112,20€			41295088	24,10€	LSAC002	24,90€	41795003	23,00€	41795003	23,00€
250	SE-R 250 Factory	19-19	41371122	-			41295088	24,10€	LSAC002	24,90€	41795003	23,00€	41795003	23,00€
250	SE-R 250 Factory	20-21	41371122	-	41291016	28,90€					41795003	23,00€	41795003	23,00€
250	SE-R 250 Factory	22-22			41291016	28,90€					41795003	23,00€	41795003	23,00€
250	SEF-R 2,5 250 4T	14-16					41295082	22,50€	LSAC001	24,90€	41795003	23,00€	41795003	23,00€
250	SEF-R 2,5 250 4T	17-19	41371120	112,20€			41295088	24,10€	LSAC002	24,90€	41795003	23,00€	41795003	23,00€
250	SEF-R 2,5 250 4T	20-20	41371120	112,20€			41295088	24,10€			41795003	23,00€	41795003	23,00€
250	SEF-R 2,5 250 4T	21-22					41295088	24,10€			41795003	23,00€	41795003	23,00€
250	SEF-R 2,5 250 4T Factory	14-16					41295082	22,50€	LSAC001	24,90€	41795003	23,00€	41795003	23,00€
250	SEF-R 2,5 250 4T Factory	17-19	41371120	112,20€			41295088	24,10€	LSAC002	24,90€	41795003	23,00€	41795003	23,00€
250	SEF-R 2,5 250 4T Factory	20-20	41371120	112,20€	41291016	28,90€					41795003	23,00€	41795003	23,00€
250	SEF-R 2,5 250 4T Factory	21-22			41291016	28,90€					41795003	23,00€	41795003	23,00€
250	Sherco 2.5 250	98-08					41295065	48,80€						
250	Sherco 2.5 250	13-14					41295065	48,80€						
250	ST 2.5 250	09-09					41295065	48,80€						
250	ST 2.5 250	10-10					41295065	48,80€						
250	ST 2.5 250	11-17			41295065	48,80€	41295065	48,80€						







Cyl	Modèle	Année	ROULEMENTS DE BRAS OSCILLANT				KIT DE RÉPARATION DE BIELLETTES			
				€ T.T.C.		€ T.T.C.		€ T.T.C.		€ T.T.C.
SHERCO										
250	ST 250	18-22	41281191	113,60€				41271198	111,70€	
250	SX 250 2,5i-F	09-11	41281196	68,10€	SAKC001	62,90€		41271189	215,80€	LRKC001 98,90€
290	Sherco 2.9 290	01-08	41281191	113,60€				41271165	211,30€	
290	Sherco 2.9 290	13-15	41281191	113,60€				41271198	111,70€	
290	ST 2.9 290	09-10	41281191	113,60€				41271165	211,30€	
290	ST 2.9 290	11-13	41281191	113,60€				41271198	111,70€	
290	X-Ride 290	11-19	41281191	113,60€						
300	SC300	19-19	41281196	68,10€	SAKC001	62,90€		41271199	203,90€	LRKC002 98,90€
300	SCF300	19-19	41281196	68,10€	SAKC001	62,90€		41271199	203,90€	LRKC002 98,90€
300	SE-R 3,0	13-16	41281196	68,10€	SAKC001	62,90€		41271189	215,80€	LRKC001 98,90€
300	SE-R 3,0 i	10-12	41281196	68,10€	SAKC001	62,90€		41271189	215,80€	LRKC001 98,90€
300	SE-R 300	15-16	41281196	68,10€	SAKC001	62,90€		41271189	215,80€	LRKC001 98,90€
300	SE-R 300	17-19	41281196	68,10€	SAKC001	62,90€		41271199	203,90€	LRKC002 98,90€
300	SE-R 300	20-21	41281196	68,10€	SAKC001	62,90€		41271199	203,90€	LRKC002 98,90€
300	SE-R 300	22-22	41281196	68,10€	SAKC001	62,90€		41271199	203,90€	LRKC002 98,90€
300	SE-R 300 Factory	13-16	41281196	68,10€	SAKC001	62,90€		41271189	215,80€	LRKC001 98,90€
300	SE-R 300 Factory	17-17	41281196	68,10€	SAKC001	62,90€		41271199	203,90€	LRKC002 98,90€
300	SE-R 300 Factory	18-18	41281196	68,10€	SAKC001	62,90€		41271199	203,90€	LRKC002 98,90€
300	SE-R 300 Factory	19-19	41281196	68,10€	SAKC001	62,90€		41271199	203,90€	LRKC002 98,90€
300	SE-R 300 Factory	20-21	41281196	68,10€	SAKC001	62,90€				
300	SE-R 300 Factory	22-22	41281196	68,10€	SAKC001	62,90€				
300	SEF-R 300 4T	14-16	41281196	68,10€	SAKC001	62,90€		41271189	215,80€	LRKC001 98,90€
300	SEF-R 300 4T	17-19	41281196	68,10€	SAKC001	62,90€		41271199	203,90€	LRKC002 98,90€
300	SEF-R 300 4T	20-20	41281196	68,10€	SAKC001	62,90€		41271199	203,90€	LRKC002 98,90€
300	SEF-R 300 4T	21-22	41281196	68,10€	SAKC001	62,90€		41271199	203,90€	LRKC002 98,90€
300	SEF-R 300 4T Factory	14-16	41281196	68,10€	SAKC001	62,90€		41271189	215,80€	LRKC001 98,90€
300	SEF-R 300 4T Factory	17-19	41281196	68,10€	SAKC001	62,90€		41271199	203,90€	LRKC002 98,90€
300	SEF-R 300 4T Factory	20-20	41281196	68,10€	SAKC001	62,90€				
300	SEF-R 300 4T Factory	21-22	41281196	68,10€	SAKC001	62,90€				
300	ST 3,0 Factory	14-14	41281191	113,60€	SAKC001	62,90€		41271198	111,70€	
300	ST 3,0 Factory	15-16	41281191	113,60€				41271198	111,70€	
300	ST 3.0 2T	13-17	41281191	113,60€				41271198	111,70€	
300	ST 3.0R 2T	13-14	41281191	113,60€				41271198	111,70€	
300	ST 300	18-22	41281191	113,60€				41271198	111,70€	
320	Sherco 3.2 320	07-08	41281191	113,60€				41271165	211,30€	
320	ST 3.2-F 320	09-10	41281191	113,60€				41271165	211,30€	
320	ST 3.2-F 320	11-13	41281191	113,60€				41271198	111,70€	
450	Enduro 4.5i 450	04-06	41281196	68,10€	SAKC001	62,90€				
450	Enduro 4.5i 450	07-08	41281196	68,10€	SAKC001	62,90€		41271189	215,80€	LRKC001 98,90€
450	SCF450	19-19	41281196	68,10€	SAKC001	62,90€		41271199	203,90€	LRKC002 98,90€
450	SE 4.5i-F 450	09-13	41281196	68,10€	SAKC001	62,90€		41271189	215,80€	LRKC001 98,90€
450	SEF-R 450	17-17	41281196	68,10€	SAKC001	62,90€		41271189	215,80€	LRKC001 98,90€
450	SEF-R 450	18-19	41281196	68,10€	SAKC001	62,90€		41271199	203,90€	LRKC002 98,90€
450	SEF-R 450	20-20	41281196	68,10€	SAKC001	62,90€		41271199	203,90€	LRKC002 98,90€
450	SEF-R 450	21-21	41281196	68,10€	SAKC001	62,90€		41271199	203,90€	LRKC002 98,90€
450	SEF-R 450 Factory	16-16	41281196	68,10€	SAKC001	62,90€		41271189	215,80€	LRKC001 98,90€
450	SEF-R 450 Factory	17-17	41281196	68,10€	SAKC001	62,90€		41271199	203,90€	LRKC002 98,90€
450	SEF-R 450 Factory	18-19	41281196	68,10€	SAKC001	62,90€		41271199	203,90€	LRKC002 98,90€
450	SEF-R 450 Factory	20-20	41281196	68,10€	SAKC001	62,90€		41271199	203,90€	LRKC002 98,90€
450	SEF-R 450 Factory	21-21	41281196	68,10€	SAKC001	62,90€				LRKC001 98,90€
450	SM 4.5i-F 450	09-13	41281196	68,10€	SAKC001	62,90€		41271189	215,80€	LRKC001 98,90€
450	Supermotard 4.5i 450	05-08	41281196	68,10€	SAKC001	62,90€		41271189	215,80€	LRKC001 98,90€
500	SCF500	19-19	41281196	68,10€	SAKC001	62,90€		41271199	203,90€	LRKC002 98,90€
500	SEF-R 500	20-20	41281196	68,10€	SAKC001	62,90€		41271199	203,90€	LRKC002 98,90€
500	SEF-R 500	21-21	41281196	68,10€	SAKC001	62,90€		41271199	203,90€	LRKC002 98,90€
500	SEF-R 500 Factory	20-20	41281196	68,10€	SAKC001	62,90€		41271199	203,90€	LRKC002 98,90€
500	SEF-R 500 Factory	21-21	41281196	68,10€	SAKC001	62,90€				LRKC001 98,90€
510	Enduro 5.1i 510	06-08	41281196	68,10€	SAKC001	62,90€		41271189	215,80€	LRKC001 98,90€
510	SE 5.1i-F 510	09-11	41281196	68,10€	SAKC001	62,90€		41271189	215,80€	LRKC001 98,90€
510	SM 5.1i-F 510	09-13	41281196	68,10€	SAKC001	62,90€		41271189	215,80€	LRKC001 98,90€
510	Supermotard 5.1i 510	07-08	41281196	68,10€	SAKC001	62,90€		41271189	215,80€	LRKC001 98,90€







Cyl	Modèle	Année	JOINT AMORT. HAUT		ROUL. AMORT. HAUT		ROUL. AMORT. BAS		ROUL. AMORT. BAS		ROULETTE DE CHAÎNE			
			€ T.T.C.	ALL BIPILES	€ T.T.C.	ALL BIPILES	€ T.T.C.	ALL BIPILES	€ T.T.C.	ALL BIPILES	Supérieure	€ T.T.C.	Inférieure	€ T.T.C.
SHERCO														
250	ST 250	18-22			41295065	48,80€	41295065	48,80€						
250	SX 250 2,5i-F	09-11					41295082	22,50€	LSAC001	24,90€				
290	Sherco 2.9 290	01-08					41295065	48,80€						
290	Sherco 2.9 290	13-15					41295065	48,80€						
290	ST 2.9 290	09-10					41295065	48,80€						
290	ST 2.9 290	11-13					41295065	48,80€						
290	X-Ride 290	11-19												
300	SC300	19-19			41291016	28,90€	41295088	24,10€	LSAC002	24,90€				
300	SCF300	19-19			41291016	28,90€	41295088	24,10€	LSAC002	24,90€				
300	SE-R 3,0	13-16					41295082	22,50€	LSAC001	24,90€	41795003	23,00€	41795003	23,00€
300	SE-R 3,0 i	10-12					41295082	22,50€	LSAC001	24,90€	41795003	23,00€	41795003	23,00€
300	SE-R 300	15-16					41295082	22,50€	LSAC001	24,90€	41795003	23,00€	41795003	23,00€
300	SE-R 300	17-19	41371120	112,20€			41295088	24,10€	LSAC002	24,90€	41795003	23,00€	41795003	23,00€
300	SE-R 300	20-21	41371120	112,20€			41295088	24,10€	LSAC002	24,90€	41795003	23,00€	41795003	23,00€
300	SE-R 300	22-22					41295088	24,10€			41795003	23,00€	41795003	23,00€
300	SE-R 300 Factory	13-16					41295082	22,50€	LSAC001	24,90€	41795003	23,00€	41795003	23,00€
300	SE-R 300 Factory	17-17					41295088	24,10€	LSAC002	24,90€	41795003	23,00€	41795003	23,00€
300	SE-R 300 Factory	18-18	41371120	112,20€			41295088	24,10€	LSAC002	24,90€	41795003	23,00€	41795003	23,00€
300	SE-R 300 Factory	19-19	41371122	-			41295088	24,10€	LSAC002	24,90€	41795003	23,00€	41795003	23,00€
300	SE-R 300 Factory	20-21	41371122	-	41291016	28,90€			LSAC002	24,90€	41795003	23,00€	41795003	23,00€
300	SE-R 300 Factory	22-22			41291016	28,90€			LSAC002	24,90€	41795003	23,00€	41795003	23,00€
300	SEF-R 300 4T	14-16					41295082	22,50€	LSAC001	24,90€	41795003	23,00€	41795003	23,00€
300	SEF-R 300 4T	17-19	41371120	112,20€			41295088	24,10€	LSAC002	24,90€	41795003	23,00€	41795003	23,00€
300	SEF-R 300 4T	20-20	41371120	112,20€			41295088	24,10€			41795003	23,00€	41795003	23,00€
300	SEF-R 300 4T	21-22					41295088	24,10€			41795003	23,00€	41795003	23,00€
300	SEF-R 300 4T Factory	14-16					41295082	22,50€	LSAC001	24,90€	41795003	23,00€	41795003	23,00€
300	SEF-R 300 4T Factory	17-19	41371120	112,20€			41295088	24,10€	LSAC002	24,90€	41795003	23,00€	41795003	23,00€
300	SEF-R 300 4T Factory	20-20	41371120	112,20€	41291016	28,90€			LSAC002	24,90€	41795003	23,00€	41795003	23,00€
300	SEF-R 300 4T Factory	21-22			41291016	28,90€			LSAC002	24,90€	41795003	23,00€	41795003	23,00€
300	ST 3,0 Factory	14-14			41295065	48,80€	41295065	48,80€	LSAC001	24,90€				
300	ST 3,0 Factory	15-16			41295065	48,80€	41295065	48,80€						
300	ST 3.0 2T	13-17			41295065	48,80€	41295065	48,80€						
300	ST 3.0R 2T	13-14			41295065	48,80€	41295065	48,80€						
300	ST 300	18-22			41295065	48,80€	41295065	48,80€						
320	Sherco 3.2 320	07-08					41295065	48,80€						
320	ST 3.2-F 320	09-10					41295065	48,80€						
320	ST 3.2-F 320	11-13					41295065	48,80€						
450	Enduro 4.5i 450	04-06					41295082	22,50€	LSAC001	24,90€				
450	Enduro 4.5i 450	07-08					41295082	22,50€	LSAC001	24,90€				
450	SCF450	19-19			41291016	28,90€	41295088	24,10€	LSAC002	24,90€	41795003	23,00€	41795003	23,00€
450	SE 4.5i-F 450	09-13					41295082	22,50€	LSAC001	24,90€	41795003	23,00€	41795003	23,00€
450	SEF-R 450	17-17	41371120	112,20€			41295082	22,50€	LSAC001	24,90€	41795003	23,00€	41795003	23,00€
450	SEF-R 450	18-19	41371120	112,20€			41295088	24,10€	LSAC002	24,90€	41795003	23,00€	41795003	23,00€
450	SEF-R 450	20-20			41291016	28,90€	41295088	24,10€	LSAC002	24,90€	41795003	23,00€	41795003	23,00€
450	SEF-R 450	21-21					41295088	24,10€			41795003	23,00€	41795003	23,00€
450	SEF-R 450 Factory	16-16					41295082	22,50€	LSAC001	24,90€	41795003	23,00€	41795003	23,00€
450	SEF-R 450 Factory	17-17					41295088	24,10€	LSAC002	24,90€	41795003	23,00€	41795003	23,00€
450	SEF-R 450 Factory	18-19	41371120	112,20€			41295088	24,10€	LSAC002	24,90€	41795003	23,00€	41795003	23,00€
450	SEF-R 450 Factory	20-20	41371122	-	41291016	28,90€	41295088	24,10€	LSAC002	24,90€	41795003	23,00€	41795003	23,00€
450	SEF-R 450 Factory	21-21									41795003	23,00€	41795003	23,00€
450	SM 4.5i-F 450	09-13					41295082	22,50€	LSAC001	24,90€				
450	Supermotard 4.5i 450	05-08					41295082	22,50€	LSAC001	24,90€				
500	SCF500	19-19			41291016	28,90€	41295088	24,10€	LSAC002	24,90€				
500	SEF-R 500	20-20					41295088	24,10€	LSAC002	24,90€				
500	SEF-R 500	21-21					41295088	24,10€						
500	SEF-R 500 Factory	20-20					41295088	24,10€	LSAC002	24,90€				
500	SEF-R 500 Factory	21-21												
510	Enduro 5.1i 510	06-08					41295082	22,50€	LSAC001	24,90€	41795003	23,00€	41795003	23,00€
510	SE 5.1i-F 510	09-11					41295082	22,50€	LSAC001	24,90€				
510	SM 5.1i-F 510	09-13					41295082	22,50€	LSAC001	24,90€				
510	Supermotard 5.1i 510	07-08					41295082	22,50€	LSAC001	24,90€	41795003	23,00€	41795003	23,00€







Cyl	Modèle	Année	ROULEMENTS DE BRAS OSCILLANT				KIT DE RÉPARATION DE BIELLETTES			
				€ T.T.C.		€ T.T.C.		€ T.T.C.		€ T.T.C.
SUZUKI										
65	RM65	03-06	41281067	62,20€				41271011	112,30€	
80	RM80	80-81								
80	RM80	82-84	41281070	69,68€						
80	RM80	85-85	41281070	69,68€						
80	RM80	86-86								
80	RM80	87-88								
80	RM80	89-89								
80	RM80	90-90	41281070	69,68€				41271057	160,60€	
80	RM80	91-01	41281063	70,88€				41271057	160,60€	
85	RM85 L	02-02	41281089	71,50€	SAKS256	60,90€		41271114	93,94€	
85	RM85 L	03-03	41281089	71,50€	SAKS256	60,90€		41271057	160,60€	
85	RM85 L	04-04	41281089	71,50€	SAKS256	60,90€		41271114	93,94€	
85	RM85 L	05-05	41281089	71,50€	SAKS256	60,90€		41271114	93,94€	
85	RM85 L	06-22	41281089	71,50€	SAKS256	60,90€		41271134	103,20€	
110	DRZ110	01-07	41281173	49,84€						
125	DR-Z 125 /L	03-15	41281121	109,20€				41271120	186,50€	
125	DR-Z 125 L	16-22	41281121	109,20€				41271120	186,50€	
125	RM125	79-80	41281102	81,92€						
125	RM125	81-81	41281008	81,92€						
125	RM125	82-83	41281008	81,92€						
125	RM125	84-84	41281008	81,92€						
125	RM125	85-85	41281008	81,92€						
125	RM125	86-86	41281008	81,92€						
125	RM125	87-88	41281008	81,92€				41271076	106,84€	
125	RM125	89-89	41281002	79,70€				41271075	106,84€	
125	RM125	90-90	41281002	79,70€				41271071	106,84€	
125	RM125	91-91	41281002	79,70€				41271072	109,70€	
125	RM125	92-92	41281045	169,10€				41271074	106,84€	
125	RM125	93-95	41281045	169,10€				41271069	212,10€	
125	RM125	96-96	41281047	83,50€				41271054	114,00€	
125	RM125	97-97	41281047	83,50€				41271064	106,84€	
125	RM125	98-99	41281047	83,50€				41271053	208,00€	
125	RM125	00-00	41281047	83,50€				41271043	173,10€	
125	RM125	01-01	41281047	83,50€	SAKS250	74,90€		41271131	106,84€	
125	RM125	02-03	41281047	83,50€	SAKS250	74,90€		41271132	111,60€	
125	RM125	04-04	41281047	83,50€	SAKS258	74,90€		41271127	112,80€	LRKS138 94,90€
125	RM125	05-13	41281047	83,50€	SAKS258	74,90€		41271127	112,80€	LRKS138 94,90€
250	DR-Z 250	01-10	41281105	147,00€				41271060	96,14€	
250	LT250 RF-RH	85-85								
250	RM-Z 250	04-06	41281115	160,90€	SAKK185	74,90€		41271117	112,80€	LRKK105 94,90€
250	RM-Z 250	07-09	41281047	83,50€	SAKS258	74,90€		41271127	112,80€	LRKS138 94,90€
250	RM-Z 250	10-11	41281047	83,50€	SAKS262	74,90€		41271179	201,00€	LRKS141 94,90€
250	RM-Z 250	12-12	41281047	83,50€	SAKS262	74,90€		41271179	201,00€	LRKS141 94,90€
250	RM-Z 250	13-16	41281047	83,50€	SAKS262	74,90€		41271181	112,40€	LRKS150 -
250	RM-Z 250	17-18	41281047	83,50€	SAKS262	74,90€		41271181	112,40€	LRKS150 -
250	RM-Z 250	19-22	41281047	83,50€	SAKS262	74,90€		41271188	111,60€	
250	RM250	79-79	41281106	81,92€						
250	RM250	80-80	41281106	81,92€						
250	RM250	81-83	41281008	81,92€						
250	RM250	84-84	41281007	81,92€						
250	RM250	85-85	41281007	81,92€						
250	RM250	86-86	41281007	81,92€						
250	RM250	87-88	41281001	81,92€				41271076	106,84€	
250	RM250	89-89	41281045	169,10€				41271075	106,84€	
250	RM250	90-90	41281045	169,10€				41271071	106,84€	
250	RM250	91-91	41281045	169,10€				41271072	109,70€	
250	RM250	92-92	41281045	169,10€				41271074	106,84€	
250	RM250	93-95	41281045	169,10€				41271069	212,10€	
250	RM250	96-97	41281047	83,50€				41271064	106,84€	
250	RM250	98-99	41281047	83,50€				41271053	208,00€	







Cyl	Modèle	Année	JOINT AMORT. HAUT		ROUL. AMORT. HAUT		ROUL. AMORT. BAS		ROUL. AMORT. BAS		ROULETTE DE CHÂÎNE 			
				€ T.T.C.		€ T.T.C.		€ T.T.C.		€ T.T.C.	Supérieure	€ T.T.C.	Inférieure	€ T.T.C.
SUZUKI														
65	RM65	03-06	41371005	101,10€			41295022	18,80€	LSAK002	18,90€	41795012	17,10€	41795009	10,90€
80	RM80	80-81									41795001	21,40€	41795001	21,40€
80	RM80	82-84									41795001	21,40€	41795001	21,40€
80	RM80	85-85	41371005	101,10€							41795001	21,40€	41795001	21,40€
80	RM80	86-86	41371005	101,10€							41795001	21,40€	41795001	21,40€
80	RM80	87-88	41371005	101,10€							41795008	20,90€	41795008	20,90€
80	RM80	89-89	41371005	101,10€							41795008	20,90€	41795008	20,90€
80	RM80	90-90	41371005	101,10€	41295008	22,30€	41295009	47,60€			41795008	20,90€	41795008	20,90€
80	RM80	91-01	41371005	101,10€	41295008	22,30€	41295009	47,60€			41795008	20,90€	41795008	20,90€
85	RM85 L	02-02	41371005	101,10€	41295018	19,00€	41295021	32,80€			41795008	20,90€	41795008	20,90€
85	RM85 L	03-03	41371005	101,10€	41295018	19,00€	41295009	47,60€			41795008	20,90€	41795008	20,90€
85	RM85 L	04-04	41371005	101,10€	41295018	19,00€	41295021	32,80€			41795008	20,90€	41795008	20,90€
85	RM85 L	05-05	41371010	97,10€	41295018	19,00€	41295021	32,80€	LSAS004	18,90€	41795008	20,90€	41795008	20,90€
85	RM85 L	06-22	41371010	97,10€	41295018	19,00€	41295025	18,80€	LSAS004	18,90€	41795008	20,90€	41795008	20,90€
110	DRZ110	01-07												
125	DR-Z 125 /L	03-15					41295024	38,30€					41795001	21,40€
125	DR-Z 125 L	16-22					41295024	38,30€					41795001	21,40€
125	RM125	79-80												
125	RM125	81-81									41795002	21,40€	41795002	21,40€
125	RM125	82-83	41371010	97,10€							41795002	21,40€	41795002	21,40€
125	RM125	84-84	41371010	97,10€							41795002	21,40€	41795006	21,40€
125	RM125	85-85	41371010	97,10€	41291008	46,20€	41291008	46,20€			41795002	21,40€	41795006	21,40€
125	RM125	86-86	41371010	97,10€	41291008	46,20€	41291008	46,20€			41795006	21,40€	41795006	21,40€
125	RM125	87-88	41371007	52,30€	41295050	24,48€	41291008	46,20€			41795002	21,40€	41795002	21,40€
125	RM125	89-89	41371007	52,30€	41295050	24,48€	41295033	50,90€			41795008	20,90€	41795002	21,40€
125	RM125	90-90	41371007	52,30€	41295050	24,48€	41295009	47,60€			41795002	21,40€	41795002	21,40€
125	RM125	91-91	41371008	99,10€	41291011	25,20€	41295009	47,60€			41795002	21,40€	41795002	21,40€
125	RM125	92-92	41371113	97,10€	41291011	25,20€	41295011	61,60€			41795002	21,40€	41795002	21,40€
125	RM125	93-95	41371113	97,10€	41291011	25,20€	41295011	61,60€			41795002	21,40€	41795002	21,40€
125	RM125	96-96			41295054	51,30€	41295025	18,80€	LSAS004	18,90€	41795002	21,40€	41795002	21,40€
125	RM125	97-97	41371113	97,10€	41295054	51,30€	41295025	18,80€	LSAS004	18,90€	41795002	21,40€	41795002	21,40€
125	RM125	98-99	41371001	52,30€	41295054	51,30€	41295025	18,80€	LSAS004	18,90€	41795002	21,40€	41795002	21,40€
125	RM125	00-00	41371001	52,30€	41295054	51,30€	41295024	38,30€			41795002	21,40€	41795002	21,40€
125	RM125	01-01	41371001	52,30€	41291003	24,90€	41295049	24,48€			41795001	21,40€	41795001	21,40€
125	RM125	02-03	41371001	52,30€	41291003	24,90€	41295025	18,80€	LSAS004	18,90€	41795001	21,40€	41795001	21,40€
125	RM125	04-04	41371001	52,30€	41291003	24,90€	41295025	18,80€	LSAS004	18,90€	41795001	21,40€	41795001	21,40€
125	RM125	05-13	41371125	109,70€	41291003	24,90€	41295025	18,80€	LSAS004	18,90€	41795001	21,40€	41795001	21,40€
250	DR-Z 250	01-10					41295020	21,50€			41795002	21,40€	41795001	21,40€
250	LT250 RF-RH	85-85			41291008	46,20€	41291008	46,20€						
250	RM-Z 250	04-06	41371004	52,90€	41291002	24,90€	41295022	18,80€	LSAK002	18,90€	41795001	21,40€	41795001	21,40€
250	RM-Z 250	07-09	41371125	109,70€	41291003	24,90€	41295025	18,80€	LSAS004	18,90€	41795001	21,40€	41795001	21,40€
250	RM-Z 250	10-11	41371125	109,70€	41291003	24,90€	41295063	55,20€	LSAS007	24,90€	41795001	21,40€	41795001	21,40€
250	RM-Z 250	12-12	41371125	109,70€	41291003	24,90€	41295063	55,20€	LSAS007	24,90€	41795001	21,40€	41795008	20,90€
250	RM-Z 250	13-16	41371125	109,70€	41291003	24,90€	41295063	55,20€	LSAS007	24,90€	41795001	21,40€	41795002	21,40€
250	RM-Z 250	17-18			41291003	24,90€	41295063	55,20€	LSAS007	24,90€	41795001	21,40€	41795002	21,40€
250	RM-Z 250	19-22			41291003	24,90€	41295063	55,20€	LSAS007	24,90€	41795001	21,40€	41795001	21,40€
250	RM250	79-79												
250	RM250	80-80									41795002	21,40€	41795002	21,40€
250	RM250	81-83	41371002	52,30€							41795002	21,40€	41795002	21,40€
250	RM250	84-84	41371002	52,30€							41795002	21,40€	41795006	21,40€
250	RM250	85-85	41371002	52,30€	41291008	46,20€	41291008	46,20€			41795002	21,40€	41795006	21,40€
250	RM250	86-86	41371002	52,30€	41291008	46,20€	41291008	46,20€			41795002	21,40€	41795002	21,40€
250	RM250	87-88	41371007	52,30€	41295050	24,48€	41291008	46,20€			41795002	21,40€	41795002	21,40€
250	RM250	89-89	41371007	52,30€	41295050	24,48€	41295033	50,90€			41795008	20,90€	41795002	21,40€
250	RM250	90-90	41371008	99,10€	41295050	24,48€	41295009	47,60€			41795002	21,40€	41795002	21,40€
250	RM250	91-91	41371008	99,10€	41291011	25,20€	41295009	47,60€			41795002	21,40€	41795002	21,40€
250	RM250	92-92	41371113	97,10€	41291011	25,20€	41295011	61,60€			41795002	21,40€	41795002	21,40€
250	RM250	93-95	41371113	97,10€	41291011	25,20€	41295011	61,60€			41795002	21,40€	41795002	21,40€
250	RM250	96-97	41371113	97,10€	41295054	51,30€	41295025	18,80€	LSAS004	18,90€	41795002	21,40€	41795002	21,40€
250	RM250	98-99	41371001	52,30€	41295054	51,30€	41295025	18,80€	LSAS004	18,90€	41795002	21,40€	41795002	21,40€







Cyl	Modèle	Année	ROULEMENTS DE BRAS OSCILLANT				KIT DE RÉPARATION DE BIELLETTES			
				€ T.T.C.		€ T.T.C.		€ T.T.C.		€ T.T.C.
SUZUKI										
250	RM250	00-00	41281047	83,50€			41271043	173,10€		
250	RM250	01-01	41281047	83,50€	SAKS250	74,90€	41271131	106,84€		
250	RM250	02-03	41281047	83,50€	SAKS250	74,90€	41271132	111,60€		
250	RM250	04-04	41281047	83,50€	SAKS258	74,90€	41271127	112,80€	LRKS138	94,90€
250	RM250	05-08	41281047	83,50€	SAKS258	74,90€	41271127	112,80€	LRKS138	94,90€
250	RMX250	89-90	41281045	169,10€			41271075	106,84€		
250	RMX250	91-98	41281045	169,10€			41271136	196,80€		
250	RMX250	99-01	41281045	169,10€			41271136	196,80€		
400	DR-Z 400 /S	00-09	41281047	83,50€	SAKS258	74,90€	41271043	173,10€		
400	DR-Z 400 E	00-07	41281047	83,50€	SAKS258	74,90€	41271043	173,10€		
400	LT-Z 400 QuadSport	03-19								
400	RM400	80-80								
450	LT-R 450 Quadracer	06-14								
450	RM-Z 450	05-09	41281047	83,50€	SAKS258	74,90€	41271127	112,80€	LRKS138	94,90€
450	RM-Z 450	10-10	41281047	83,50€	SAKS258	74,90€	41271179	201,00€	LRKS141	94,90€
450	RM-Z 450	11-12	41281047	83,50€	SAKS258	74,90€	41271179	201,00€	LRKS141	94,90€
450	RM-Z 450	13-13	41281047	83,50€	SAKS258	74,90€	41271179	201,00€	LRKS141	94,90€
450	RM-Z 450	14-14	41281047	83,50€	SAKS258	74,90€	41271181	112,40€	LRKS150	-
450	RM-Z 450	15-16	41281047	83,50€	SAKS258	74,90€	41271181	112,40€	LRKS150	-
450	RM-Z 450	17-17	41281047	83,50€	SAKS262	74,90€	41271181	112,40€	LRKS150	-
450	RM-Z 450	18-22	41281047	83,50€	SAKS262	74,90€	41271188	111,60€		
450	RMX450 Z	10-15	41281047	83,50€	SAKS258	74,90€	41271179	201,00€	LRKS141	94,90€
500	RM500	83-83	41281008	81,92€						
500	RM500	84-84	41281008	81,92€						
500	RM500	85-85								
TM										
125	Cross MX125	98-04	41281183	61,80€						
125	Cross MX125	05-06	41281183	61,80€			41271156	103,20€		
125	Cross MX125	07-07	41281183	61,80€			41271163	114,00€		
125	Cross MX125	08-11					41271163	114,00€		
125	Enduro 125	98-04	41281183	61,80€						
125	Enduro EN125	05-06	41281183	61,80€			41271156	103,20€		
125	Enduro EN125	07-07	41281183	61,80€			41271163	114,00€		
125	Enduro EN125	08-11					41271163	114,00€		
125	SMR125	09-10					41271163	114,00€		
250	Cross 250 /F	01-04	41281183	61,80€						
250	Cross 250 /F	05-06	41281183	61,80€			41271156	103,20€		
250	Cross 250 /F	07-07	41281183	61,80€			41271163	114,00€		
250	Cross 250 /F	08-11					41271163	114,00€		
250	Enduro 250 /F	01-07								
250	Enduro 250 /F	09-11					41271163	114,00€		
300	Cross 300	01-04	41281183	61,80€						
300	Cross 300	05-06	41281183	61,80€			41271156	103,20€		
300	Cross 300	07-07	41281183	61,80€			41271163	114,00€		
300	Cross 300	08-11					41271163	114,00€		
300	Enduro 300	01-04	41281183	61,80€						
300	Enduro 300	05-06	41281183	61,80€			41271156	103,20€		
300	Enduro 300	07-07	41281183	61,80€			41271163	114,00€		
300	Enduro 300	08-11					41271163	114,00€		
400	Cross 400	02-03	41281183	61,80€						
400	Enduro 400	01-01	41281183	61,80€						
450	Cross 450 F	02-03	41281183	61,80€						
450	Cross 450 F	04-04	41281183	61,80€						
450	Cross 450 F	05-06	41281183	61,80€			41271156	103,20€		
450	Cross 450 F	07-07	41281183	61,80€			41271163	114,00€		
450	Cross 450 F	08-11					41271163	114,00€		
450	Enduro 450 F	02-03	41281183	61,80€						
450	Enduro 450 F	04-04	41281183	61,80€						
450	Enduro 450 F	05-06	41281183	61,80€			41271156	103,20€		
450	Enduro 450 F	07-07	41281183	61,80€			41271163	114,00€		







Cyl	Modèle	Année	JOINT AMORT. HAUT		ROUL. AMORT. HAUT		ROUL. AMORT. BAS		ROUL. AMORT. BAS		ROULETTE DE CHAÎNE 			
				€ T.T.C.		€ T.T.C.		€ T.T.C.		€ T.T.C.	Supérieure	€ T.T.C.	Inférieure	€ T.T.C.
SUZUKI														
250	RM250	00-00	41371001	52,30€	41295054	51,30€	41295024	38,30€			41795002	21,40€	41795002	21,40€
250	RM250	01-01	41371002	52,30€	41291003	24,90€	41295049	24,48€			41795001	21,40€	41795001	21,40€
250	RM250	02-03	41371002	52,30€	41291003	24,90€	41295025	18,80€	LSAS004	18,90€	41795001	21,40€	41795001	21,40€
250	RM250	04-04	41371001	52,30€	41291003	24,90€	41295025	18,80€	LSAS004	18,90€	41795001	21,40€	41795001	21,40€
250	RM250	05-08	41371125	109,70€	41291003	24,90€	41295025	18,80€	LSAS004	18,90€	41795001	21,40€	41795001	21,40€
250	RMX250	89-90	41371007	52,30€	41295050	24,48€	41295033	50,90€			41795002	21,40€	41795002	21,40€
250	RMX250	91-98	41371008	99,10€	41291011	25,20€	41295011	61,60€			41795002	21,40€	41795002	21,40€
250	RMX250	99-01			41291011	25,20€	41295011	61,60€			41795002	21,40€	41795002	21,40€
400	DR-Z 400 /S	00-09	41371001	52,30€	41295054	51,30€	41295024	38,30€			41795002	21,40€	41795001	21,40€
400	DR-Z 400 E	00-07	41371001	52,30€	41295054	51,30€	41295024	38,30€			41795002	21,40€	41795001	21,40€
400	LT-Z 400 QuadSport	03-19					41295025	18,80€						
400	RM400	80-80									41795002	21,40€	41795002	21,40€
450	LT-R 450 Quadracer	06-14			41291003	24,90€	41295025	18,80€						
450	RM-Z 450	05-09	41371125	109,70€	41291003	24,90€	41295025	18,80€	LSAS004	18,90€	41795001	21,40€	41795001	21,40€
450	RM-Z 450	10-10	41371125	109,70€	41291003	24,90€	41295063	55,20€	LSAS007	24,90€	41795001	21,40€	41795001	21,40€
450	RM-Z 450	11-12	41371125	109,70€	41291003	24,90€	41295063	55,20€	LSAS007	24,90€	41795001	21,40€	41795008	20,90€
450	RM-Z 450	13-13	41371125	109,70€	41291003	24,90€	41295063	55,20€	LSAS007	24,90€	41795001	21,40€	41795002	21,40€
450	RM-Z 450	14-14	41371125	109,70€	41291003	24,90€	41295063	55,20€	LSAS007	24,90€	41795001	21,40€	41795002	21,40€
450	RM-Z 450	15-16	41371125	109,70€	41291003	24,90€	41295063	55,20€	LSAS007	24,90€	41795001	21,40€	41795001	21,40€
450	RM-Z 450	17-17	41371125	109,70€	41291003	24,90€	41295063	55,20€	LSAS007	24,90€	41795001	21,40€	41795001	21,40€
450	RM-Z 450	18-22			41291003	24,90€	41295063	55,20€	LSAS007	24,90€	41795001	21,40€	41795001	21,40€
450	RMX450 Z	10-15			41291003	24,90€	41295063	55,20€	LSAS007	24,90€	41795001	21,40€	41795001	21,40€
500	RM500	83-83									41795002	21,40€	41795002	21,40€
500	RM500	84-84									41795002	21,40€	41795006	21,40€
500	RM500	85-85									41795002	21,40€	41795006	21,40€
TM														
125	Cross MX125	98-04					41295057	47,50€			41795001	21,40€	41795001	21,40€
125	Cross MX125	05-06					41295058	24,48€			41795001	21,40€	41795001	21,40€
125	Cross MX125	07-07					41295061	54,50€			41795001	21,40€	41795001	21,40€
125	Cross MX125	08-11					41295061	54,50€						
125	Enduro 125	98-04					41295057	47,50€			41795001	21,40€	41795001	21,40€
125	Enduro EN125	05-06					41295058	24,48€			41795001	21,40€	41795001	21,40€
125	Enduro EN125	07-07					41295061	54,50€			41795001	21,40€	41795001	21,40€
125	Enduro EN125	08-11					41295061	54,50€						
125	SMR125	09-10					41295061	54,50€						
250	Cross 250 /F	01-04					41295057	47,50€			41795001	21,40€	41795001	21,40€
250	Cross 250 /F	05-06					41295058	24,48€			41795001	21,40€	41795001	21,40€
250	Cross 250 /F	07-07					41295061	54,50€			41795001	21,40€	41795001	21,40€
250	Cross 250 /F	08-11					41295061	54,50€						
250	Enduro 250 /F	01-07									41795001	21,40€	41795001	21,40€
250	Enduro 250 /F	09-11					41295061	54,50€						
300	Cross 300	01-04					41295057	47,50€			41795001	21,40€	41795001	21,40€
300	Cross 300	05-06					41295058	24,48€			41795001	21,40€	41795001	21,40€
300	Cross 300	07-07					41295061	54,50€			41795001	21,40€	41795001	21,40€
300	Cross 300	08-11					41295061	54,50€						
300	Enduro 300	01-04					41295057	47,50€			41795001	21,40€	41795001	21,40€
300	Enduro 300	05-06					41295058	24,48€			41795001	21,40€	41795001	21,40€
300	Enduro 300	07-07					41295061	54,50€			41795001	21,40€	41795001	21,40€
300	Enduro 300	08-11					41295061	54,50€						
400	Cross 400	02-03					41295057	47,50€						
400	Enduro 400	01-01					41295057	47,50€						
450	Cross 450 F	02-03					41295057	47,50€						
450	Cross 450 F	04-04					41295057	47,50€			41795001	21,40€	41795001	21,40€
450	Cross 450 F	05-06					41295058	24,48€			41795001	21,40€	41795001	21,40€
450	Cross 450 F	07-07					41295061	54,50€			41795001	21,40€	41795001	21,40€
450	Cross 450 F	08-11					41295061	54,50€						
450	Enduro 450 F	02-03					41295057	47,50€						
450	Enduro 450 F	04-04					41295057	47,50€			41795001	21,40€	41795001	21,40€
450	Enduro 450 F	05-06					41295058	24,48€			41795001	21,40€	41795001	21,40€
450	Enduro 450 F	07-07					41295061	54,50€			41795001	21,40€	41795001	21,40€







Cyl	Modèle	Année	ROULEMENTS DE BRAS OSCILLANT				KIT DE RÉPARATION DE BIELLETES			
				€ T.T.C.		€ T.T.C.		€ T.T.C.		€ T.T.C.
TM										
450	Enduro 450 F	08-11					41271163	114,00€		
450	SMR450 F	09-09					41271163	114,00€		
450	SMX450 F	05-07	41281183	61,80€			41271157	103,20€		
530	Cross 530 F	01-01	41281183	61,80€						
530	Cross 530 F	02-04	41281183	61,80€						
530	Cross 530 F	05-06	41281183	61,80€			41271156	103,20€		
530	Cross 530 F	07-07	41281183	61,80€			41271163	114,00€		
530	Cross 530 F	08-11					41271163	114,00€		
530	Enduro 530 F	01-01	41281183	61,80€						
530	Enduro 530 F	02-04	41281183	61,80€						
530	Enduro 530 F	05-06	41281183	61,80€			41271156	103,20€		
530	Enduro 530 F	07-07	41281183	61,80€			41271163	114,00€		
530	Enduro 530 F	08-11					41271163	114,00€		
530	SMR530 F	08-11					41271163	114,00€		
600	SMX600 F	05-07								
660	SMX660 F	05-05								
660	SMX660 F	06-06	41281183	61,80€			41271157	103,20€		
660	SMX660 F	07-07	41281183	61,80€			41271163	114,00€		
660	SMX660 F	08-09					41271163	114,00€		
YAMAHA										
65	YZ 65	18-22	41281061	58,70€						
80	YZ80	80-82								
80	YZ80	83-83								
80	YZ80	84-92	41281060	104,50€			41271001	166,00€		
80	YZ80	93-98	41281062	57,00€			41271058	113,60€		
80	YZ80	99-01	41281061	58,70€			41271058	113,60€		
85	YZ85 /LW	02-02	41281061	58,70€			41271058	113,60€		
85	YZ85 /LW	03-18	41281061	58,70€			41271095	108,50€	LRKY121	-
85	YZ85 /LW	19-22	41281061	58,70€			41271193	100,40€		
125	TT125 R	00-22	41281098	104,50€			41271097	172,90€		
125	YZ125	78-79								
125	YZ125	80-80	41281143	59,50€						
125	YZ125	81-82	41281143	59,50€						
125	YZ125	83-83	41281022	142,90€			41271109	107,40€		
125	YZ125	84-85	41281022	142,90€			41271109	107,40€		
125	YZ125	86-86	41281024	149,30€			41271081	109,70€		
125	YZ125	87-87	41281031	81,92€			41271080	208,00€		
125	YZ125	88-88	41281071	81,92€			41271080	208,00€		
125	YZ125	89-92	41281071	81,92€			41271084	114,00€		
125	YZ125	93-93	41281077	81,92€			41271088	111,60€		
125	YZ125	94-97	41281078	83,30€			41271088	111,60€		
125	YZ125	98-98	41281076	81,92€			41271088	111,60€		
125	YZ125	99-00	41281073	85,60€	SAKY262	74,90€	41271088	111,60€		
125	YZ125	01-01	41281073	85,60€	SAKY262	74,90€	41271067	208,00€	LRKY116	94,90€
125	YZ125	02-04	41281072	82,60€	SAKY275	74,90€	41271065	112,80€	LRKY124	94,90€
125	YZ125	05-05	41281161	81,92€	SAKY300	74,90€	41271129	106,84€	LRKY126	94,90€
125	YZ125	06-07	41281160	82,60€	SAKY279	74,90€	41271170	114,00€	LRKY128	94,90€
125	YZ125	08-22	41281060	104,50€	SAKY279	74,90€	41271170	114,00€	LRKY128	94,90€
200	WR200 R	91-97	41281148	58,76€			41271159	186,50€		
225	TT225R	01-01	41281122	109,20€						
230	TT230R	05-05	41281122	109,20€			41271143	190,20€		
230	TT230R	06-16	41281122	109,20€			41271143	190,20€		
250	TT250 R	99-07	41281096	57,00€			41271094	190,20€		
250	WR250	91-93	41281075	85,60€			41271084	114,00€		
250	WR250	94-97	41281078	83,30€			41271088	111,60€		
250	WR250 F	01-01	41281073	85,60€	SAKY262	74,90€	41271067	208,00€	LRKY116	94,90€
250	WR250 F	02-04	41281072	82,60€	SAKY275	74,90€	41271065	112,80€	LRKY124	94,90€
250	WR250 F	05-05	41281072	82,60€	SAKY275	74,90€	41271128	106,84€	LRKY126	94,90€
250	WR250 F	06-06	41281158	85,60€	SAKY282	74,90€	41271142	103,20€	LRKY134	94,90€
250	WR250 F	07-13	41281158	85,60€	SAKY282	74,90€	41271145	201,00€	LRKY130	94,90€







Cyl	Modèle	Année	JOINT AMORT. HAUT		ROUL. AMORT. HAUT		ROUL. AMORT. BAS		ROUL. AMORT. BAS		ROULETTE DE CHAÎNE 			
				€ T.T.C.		€ T.T.C.		€ T.T.C.		€ T.T.C.	Supérieure	€ T.T.C.	Inférieure	€ T.T.C.
TM														
450	Enduro 450 F	08-11					41295061	54,50€						
450	SMR450 F	09-09					41295061	54,50€						
450	SMX450 F	05-07					41295057	47,50€			41795001	21,40€		
530	Cross 530 F	01-01					41295057	47,50€						
530	Cross 530 F	02-04					41295057	47,50€			41795001	21,40€	41795001	21,40€
530	Cross 530 F	05-06					41295058	24,48€			41795001	21,40€	41795001	21,40€
530	Cross 530 F	07-07					41295061	54,50€			41795001	21,40€	41795001	21,40€
530	Cross 530 F	08-11					41295061	54,50€						
530	Enduro 530 F	01-01					41295057	47,50€						
530	Enduro 530 F	02-04					41295057	47,50€			41795001	21,40€	41795001	21,40€
530	Enduro 530 F	05-06					41295058	24,48€			41795001	21,40€	41795001	21,40€
530	Enduro 530 F	07-07					41295061	54,50€			41795001	21,40€	41795001	21,40€
530	Enduro 530 F	08-11					41295061	54,50€						
530	SMR530 F	08-11					41295061	54,50€						
600	SMX600 F	05-07									41795001	21,40€		
660	SMX660 F	05-05									41795001	21,40€		
660	SMX660 F	06-06					41295057	47,50€			41795001	21,40€		
660	SMX660 F	07-07					41295061	54,50€			41795001	21,40€		
660	SMX660 F	08-09					41295061	54,50€						
YAMAHA														
65	YZ 65	18-22	41371012	99,10€			41295085	37,20€					41795008	20,90€
80	YZ80	80-82	41371115	101,00€									41795002	21,40€
80	YZ80	83-83	41371115	101,00€									41795009	10,90€
80	YZ80	84-92	41371115	101,00€									41795009	10,90€
80	YZ80	93-98	41371010	97,10€			41295013	52,30€					41795009	10,90€
80	YZ80	99-01	41371010	97,10€			41295013	52,30€					41795009	10,90€
85	YZ85 /LW	02-02	41371010	97,10€			41295013	52,30€					41795009	10,90€
85	YZ85 /LW	03-18	41371010	97,10€			41295015	23,30€	LSAY002	21,90€			41795009	10,90€
85	YZ85 /LW	19-22	41371010	97,10€			41295086	20,40€					41795009	10,90€
125	TT125 R	00-22					41295075	22,00€					41795009	10,90€
125	YZ125	78-79	41371116	99,10€							41795002	21,40€	41795002	21,40€
125	YZ125	80-80	41371116	99,10€							41795002	21,40€	41795002	21,40€
125	YZ125	81-82	41371116	99,10€							41795008	20,90€		
125	YZ125	83-83	41371116	99,10€	41291020	34,70€	41295027	28,90€			41795009	10,90€		
125	YZ125	84-85	41371115	101,00€	41291020	34,70€	41295027	28,90€			41795009	10,90€		
125	YZ125	86-86	41371116	99,10€	41291020	34,70€	41295027	28,90€			41795008	20,90€	41795008	20,90€
125	YZ125	87-87	41371116	99,10€	41291020	34,70€	41295027	28,90€			41795007	21,40€	41795008	20,90€
125	YZ125	88-88	41371116	99,10€	41291020	34,70€	41295027	28,90€			41795007	21,40€	41795008	20,90€
125	YZ125	89-92			41291010	25,50€	41295013	52,30€			41795007	21,40€	41795007	21,40€
125	YZ125	93-93	41371002	52,30€	41291010	25,50€	41295016	25,30€			41795007	21,40€	41795008	20,90€
125	YZ125	94-97	41371002	52,30€	41291010	25,50€	41295016	25,30€			41795007	21,40€	41795008	20,90€
125	YZ125	98-98	41371002	52,30€	41291016	28,90€	41295016	25,30€			41795007	21,40€	41795008	20,90€
125	YZ125	99-00	41371002	52,30€	41291016	28,90€	41295016	25,30€			41795007	21,40€	41795008	20,90€
125	YZ125	01-01	41371002	52,30€	41291016	28,90€	41295015	23,30€	LSAY002	21,90€	41795007	21,40€	41795008	20,90€
125	YZ125	02-04	41371002	52,30€	41291016	28,90€	41295015	23,30€	LSAY002	21,90€	41795007	21,40€	41795008	20,90€
125	YZ125	05-05	41371002	52,30€	41291016	28,90€	41295015	23,30€	LSAY002	21,90€	41795007	21,40€	41795008	20,90€
125	YZ125	06-07	41371117	51,80€	41291016	28,90€	41295015	23,30€	LSAY002	21,90€	41795007	21,40€	41795008	20,90€
125	YZ125	08-22	41371117	51,80€	41291016	28,90€	41295015	23,30€	LSAY002	21,90€	41795007	21,40€	41795008	20,90€
200	WR200 R	91-97					41295013	52,30€			41795008	20,90€	41795008	20,90€
225	TT225R	01-01					41295075	22,00€						
230	TT230R	05-05					41295064	46,20€						
230	TT230R	06-16					41295064	46,20€					41795008	20,90€
250	TT250 R	99-07					41295013	52,30€					41795008	20,90€
250	WR250	91-93			41291010	25,50€	41295013	52,30€			41795007	21,40€	41795007	21,40€
250	WR250	94-97	41371002	52,30€	41291010	25,50€	41295016	25,30€			41795007	21,40€	41795008	20,90€
250	WR250 F	01-01	41371002	52,30€	41291016	28,90€	41295015	23,30€	LSAY002	21,90€	41795007	21,40€	41795008	20,90€
250	WR250 F	02-04	41371002	52,30€	41291016	28,90€	41295015	23,30€	LSAY002	21,90€	41795007	21,40€	41795008	20,90€
250	WR250 F	05-05	41371002	52,30€	41291016	28,90€	41295015	23,30€	LSAY002	21,90€	41795007	21,40€	41795008	20,90€
250	WR250 F	06-06	41371002	52,30€	41291016	28,90€	41295015	23,30€	LSAY002	21,90€	41795007	21,40€	41795008	20,90€
250	WR250 F	07-13	41371002	52,30€	41291016	28,90€	41295015	23,30€	LSAY002	21,90€	41795007	21,40€	41795008	20,90€







Cyl	Modèle	Année	ROULEMENTS DE BRAS OSCILLANT				KIT DE RÉPARATION DE BIELLETTES			
				€ T.T.C.		€ T.T.C.		€ T.T.C.		€ T.T.C.
YAMAHA										
250	WR250 F	14-14	41281158	85,60€	SAKY282	74,90€	41271145	201,00€	LRKY130	94,90€
250	WR250 F	15-19	41281202	164,20€	SAKY283	74,90€	41271171	114,00€	LRKY132	94,90€
250	WR250 F	20-22	41281202	164,20€	SAKY283	74,90€	41271171	114,00€	LRKY132	94,90€
250	WR250 Z	91-91	41281078	83,30€			41271088	111,60€		
250	WR250 Z	92-93	41281078	83,30€			41271088	111,60€		
250	WR250 Z	94-97	41281078	83,30€			41271088	111,60€		
250	YFM250 Timberwolf	95-99	41281058	35,10€						
250	YZ250	80-80	41281143	59,50€						
250	YZ250	81-81	41281143	59,50€						
250	YZ250	82-82	41281143	59,50€						
250	YZ250	83-85	41281026	79,70€			41271109	107,40€		
250	YZ250	86-86	41281025	81,92€			41271081	109,70€		
250	YZ250	87-87	41281032	81,92€			41271081	109,70€		
250	YZ250	88-88	41281075	85,60€			41271080	208,00€		
250	YZ250	89-89	41281075	85,60€			41271080	208,00€		
250	YZ250	90-92	41281075	85,60€			41271084	114,00€		
250	YZ250	93-97	41281078	83,30€			41271088	111,60€		
250	YZ250	98-98	41281076	81,92€			41271088	111,60€		
250	YZ250	99-00	41281073	85,60€	SAKY262	74,90€	41271088	111,60€		
250	YZ250	01-01	41281073	85,60€	SAKY262	74,90€	41271067	208,00€	LRKY116	94,90€
250	YZ250	02-04	41281072	82,60€	SAKY275	74,90€	41271065	112,80€	LRKY124	94,90€
250	YZ250	05-05	41281072	82,60€	SAKY275	74,90€	41271129	106,84€	LRKY126	94,90€
250	YZ250	06-22	41281158	85,60€	SAKY275	74,90€	41271170	114,00€	LRKY128	94,90€
250	YZ250 F	01-01	41281073	85,60€	SAKY262	74,90€	41271067	208,00€	LRKY116	94,90€
250	YZ250 F	02-03	41281072	82,60€	SAKY275	74,90€	41271067	208,00€	LRKY124	94,90€
250	YZ250 F	04-04	41281072	82,60€	SAKY275	74,90€	41271065	112,80€	LRKY124	94,90€
250	YZ250 F	05-05	41281072	82,60€	SAKY275	74,90€	41271128	106,84€	LRKY126	94,90€
250	YZ250 F	06-06	41281158	85,60€	SAKY275	74,90€	41271145	201,00€	LRKY130	94,90€
250	YZ250 F	07-07	41281158	85,60€	SAKY282	74,90€	41271129	106,84€	LRKY129	94,90€
250	YZ250 F	08-08	41281158	85,60€	SAKY282	74,90€	41271145	201,00€	LRKY131	94,90€
250	YZ250 F	09-09	41281158	85,60€	SAKY282	74,90€	41271171	114,00€	LRKY132	94,90€
250	YZ250 F	10-11	41281158	85,60€	SAKY282	74,90€	41271177	203,20€	LRKY133	94,90€
250	YZ250 F	12-13	41281158	85,60€	SAKY282	74,90€	41271177	203,20€	LRKY133	94,90€
250	YZ250 F	14-18	41281158	85,60€	SAKY283	74,90€	41271177	203,20€	LRKY132	94,90€
250	YZ250 F	19-22	41281158	85,60€	SAKY283	74,90€	41271177	203,20€	LRKY132	94,90€
250	YZ250 X	16-19	41281158	85,60€	SAKY282	74,90€	41271170	114,00€	LRKY128	94,90€
350	TT350	86-86	41281140	51,60€						
350	TT350	87-87	41281140	51,60€						
350	TT350	88-97								
350	YFM350 FX Wolverine	95-04	41281058	35,10€						
350	YFM350 X Warrior	87-04								
350	YFZ350 Banshee	90-05								
400	WR400 F	98-98	41281076	81,92€			41271088	111,60€		
400	WR400 F	99-01	41281073	85,60€	SAKY262	74,90€	41271088	111,60€		
400	YZ400 F	98-98	41281076	81,92€			41271088	111,60€		
400	YZ400 F	99-99	41281073	85,60€	SAKY262	74,90€	41271088	111,60€		
426	WR426 F	01-01	41281073	85,60€	SAKY262	74,90€	41271067	208,00€	LRKY116	94,90€
426	WR426 F	02-02	41281072	82,60€	SAKY275	74,90€	41271065	112,80€	LRKY124	94,90€
426	YZ426 F	00-00	41281073	85,60€	SAKY262	74,90€	41271088	111,60€		
426	YZ426 F	01-01	41281073	85,60€	SAKY262	74,90€	41271067	208,00€	LRKY116	94,90€
426	YZ426 F	02-02	41281072	82,60€	SAKY275	74,90€	41271065	112,80€	LRKY124	94,90€
450	WR450 F	03-04	41281072	82,60€	SAKY275	74,90€	41271065	112,80€	LRKY124	94,90€
450	WR450 F	05-05	41281072	82,60€	SAKY275	74,90€	41271128	106,84€	LRKY126	94,90€
450	WR450 F	06-06	41281158	85,60€	SAKY282	74,90€	41271142	103,20€	LRKY134	94,90€
450	WR450 F	07-15	41281158	85,60€	SAKY282	74,90€	41271145	201,00€	LRKY130	94,90€
450	WR450 F	16-19	41281202	164,20€	SAKY283	74,90€	41271171	114,00€	LRKY132	94,90€
450	WR450 F	20-22	41281202	164,20€	SAKY283	74,90€	41271171	114,00€	LRKY132	94,90€
450	YZ450 F	03-04	41281072	82,60€	SAKY275	74,90€	41271065	112,80€	LRKY124	94,90€
450	YZ450 F	05-05	41281072	82,60€	SAKY275	74,90€	41271128	106,84€	LRKY126	94,90€
450	YZ450 F	06-08	41281158	85,60€	SAKY282	74,90€	41271145	201,00€	LRKY130	94,90€







Cyl	Modèle	Année	JOINT AMORT. HAUT		ROUL. AMORT. HAUT		ROUL. AMORT. BAS		ROUL. AMORT. BAS		ROULETTE DE CHAÎNE 			
				€ T.T.C.		€ T.T.C.		€ T.T.C.		€ T.T.C.	Supérieure	€ T.T.C.	Inférieure	€ T.T.C.
YAMAHA														
250	WR250 F	14-14	41371001	52,30€	41291016	28,90€	41295015	23,30€	LSAY002	21,90€	41795007	21,40€	41795008	20,90€
250	WR250 F	15-19	41371001	52,30€	41291016	28,90€	41295015	23,30€	LSAY002	21,90€	41795007	21,40€	41795008	20,90€
250	WR250 F	20-22			41291016	28,90€	41295015	23,30€	LSAY002	21,90€	41795007	21,40€	41795008	20,90€
250	WR250 Z	91-91			41291010	25,50€	41295016	25,30€						
250	WR250 Z	92-93			41291010	25,50€	41295016	25,30€			41795007	21,40€	41795008	20,90€
250	WR250 Z	94-97	41371002	52,30€	41291010	25,50€	41295016	25,30€			41795007	21,40€	41795008	20,90€
250	YFM250 Timberwolf	95-99												
250	YZ250	80-80	41371116	99,10€							41795002	21,40€	41795002	21,40€
250	YZ250	81-81	41371116	99,10€							41795008	20,90€	41795008	20,90€
250	YZ250	82-82	41371117	51,80€							41795009	10,90€		
250	YZ250	83-85	41371116	99,10€	41291020	34,70€	41295027	28,90€			41795009	10,90€	41795009	10,90€
250	YZ250	86-86	41371116	99,10€	41291020	34,70€	41295027	28,90€			41795009	10,90€	41795009	10,90€
250	YZ250	87-87	41371116	99,10€	41291020	34,70€	41295027	28,90€			41795007	21,40€	41795007	21,40€
250	YZ250	88-88	41371116	99,10€	41291020	34,70€	41295027	28,90€			41795007	21,40€	41795007	21,40€
250	YZ250	89-89			41291010	25,50€	41295027	28,90€			41795007	21,40€	41795007	21,40€
250	YZ250	90-92			41291010	25,50€	41295013	52,30€			41795007	21,40€	41795007	21,40€
250	YZ250	93-97	41371002	52,30€	41291010	25,50€	41295016	25,30€			41795007	21,40€	41795008	20,90€
250	YZ250	98-98	41371002	52,30€	41291016	28,90€	41295015	23,30€	LSAY002	21,90€	41795007	21,40€	41795008	20,90€
250	YZ250	99-00	41371002	52,30€	41291016	28,90€	41295015	23,30€	LSAY002	21,90€	41795007	21,40€	41795008	20,90€
250	YZ250	01-01	41371002	52,30€	41291016	28,90€	41295015	23,30€	LSAY002	21,90€	41795007	21,40€	41795008	20,90€
250	YZ250	02-04	41371002	52,30€	41291016	28,90€	41295015	23,30€	LSAY002	21,90€	41795007	21,40€	41795008	20,90€
250	YZ250	05-05	41371002	52,30€	41291016	28,90€	41295015	23,30€	LSAY002	21,90€	41795007	21,40€	41795008	20,90€
250	YZ250	06-22	41371117	51,80€	41291016	28,90€	41295015	23,30€	LSAY002	21,90€	41795007	21,40€	41795008	20,90€
250	YZ250 F	01-01	41371002	52,30€	41291016	28,90€	41295015	23,30€	LSAY002	21,90€	41795007	21,40€	41795008	20,90€
250	YZ250 F	02-03	41371002	52,30€	41291016	28,90€	41295015	23,30€	LSAY002	21,90€	41795007	21,40€	41795008	20,90€
250	YZ250 F	04-04	41371002	52,30€	41291016	28,90€	41295015	23,30€	LSAY002	21,90€	41795007	21,40€	41795008	20,90€
250	YZ250 F	05-05	41371002	52,30€	41291016	28,90€	41295015	23,30€	LSAY002	21,90€	41795007	21,40€	41795008	20,90€
250	YZ250 F	06-06	41371117	51,80€	41291016	28,90€	41295015	23,30€	LSAY002	21,90€	41795007	21,40€	41795008	20,90€
250	YZ250 F	07-07	41371117	51,80€	41291016	28,90€	41295015	23,30€	LSAY002	21,90€	41795007	21,40€	41795008	20,90€
250	YZ250 F	08-08	41371117	51,80€	41291016	28,90€	41295015	23,30€	LSAY002	21,90€	41795007	21,40€	41795008	20,90€
250	YZ250 F	09-09	41371117	51,80€	41291016	28,90€	41295015	23,30€	LSAY002	21,90€	41795007	21,40€	41795008	20,90€
250	YZ250 F	10-11	41371117	51,80€	41291016	28,90€	41295015	23,30€	LSAY002	21,90€	41795007	21,40€	41795008	20,90€
250	YZ250 F	12-13	41371004	52,90€	41291016	28,90€	41295015	23,30€	LSAY002	21,90€	41795007	21,40€	41795008	20,90€
250	YZ250 F	14-18	41341001	-	41291016	28,90€	41295015	23,30€	LSAY002	21,90€	41795007	21,40€	41795008	20,90€
250	YZ250 F	19-22	41341001	-	41291016	28,90€	41295015	23,30€	LSAY002	21,90€	41795008	20,90€	41795008	20,90€
250	YZ250 X	16-19	41371117	51,80€	41291016	28,90€	41295015	23,30€	LSAY002	21,90€	41795007	21,40€	41795008	20,90€
350	TT350	86-86									41795008	20,90€	41795008	20,90€
350	TT350	87-87			41295027	28,90€					41795008	20,90€	41795008	20,90€
350	TT350	88-97									41795008	20,90€	41795008	20,90€
350	YFM350 FX Wolverine	95-04												
350	YFM350 X Warrior	87-04			41291020	34,70€	41295027	28,90€						
350	YFZ350 Banshee	90-05			41291020	34,70€	41295027	28,90€						
400	WR400 F	98-98	41371002	52,30€	41291016	28,90€	41295016	25,30€			41795008	20,90€	41795007	21,40€
400	WR400 F	99-01	41371002	52,30€	41291016	28,90€	41295016	25,30€			41795007	21,40€	41795008	20,90€
400	YZ400 F	98-98	41371002	52,30€	41291016	28,90€	41295016	25,30€			41795007	21,40€	41795008	20,90€
400	YZ400 F	99-99	41371002	52,30€	41291016	28,90€	41295016	25,30€			41795007	21,40€	41795008	20,90€
426	WR426 F	01-01	41371002	52,30€	41291016	28,90€	41295015	23,30€	LSAY002	21,90€	41795007	21,40€	41795008	20,90€
426	WR426 F	02-02	41371002	52,30€	41291016	28,90€	41295015	23,30€	LSAY002	21,90€	41795007	21,40€	41795008	20,90€
426	YZ426 F	00-00	41371002	52,30€	41291016	28,90€	41295016	25,30€			41795007	21,40€	41795008	20,90€
426	YZ426 F	01-01	41371002	52,30€	41291016	28,90€	41295015	23,30€	LSAY002	21,90€	41795007	21,40€	41795008	20,90€
426	YZ426 F	02-02	41371002	52,30€	41291016	28,90€	41295015	23,30€	LSAY002	21,90€	41795007	21,40€	41795008	20,90€
450	WR450 F	03-04	41371002	52,30€	41291016	28,90€	41295015	23,30€	LSAY002	21,90€	41795007	21,40€	41795008	20,90€
450	WR450 F	05-05	41371002	52,30€	41291016	28,90€	41295015	23,30€	LSAY002	21,90€	41795007	21,40€	41795008	20,90€
450	WR450 F	06-06	41371002	52,30€	41291016	28,90€	41295015	23,30€	LSAY002	21,90€	41795007	21,40€	41795008	20,90€
450	WR450 F	07-15	41371002	52,30€	41291016	28,90€	41295015	23,30€	LSAY002	21,90€	41795007	21,40€	41795008	20,90€
450	WR450 F	16-19	41371002	52,30€	41291016	28,90€	41295015	23,30€	LSAY002	21,90€	41795007	21,40€	41795008	20,90€
450	WR450 F	20-22	41371002	52,30€	41291016	28,90€	41295015	23,30€	LSAY002	21,90€	41795008	20,90€	41795008	20,90€
450	YZ450 F	03-04	41371002	52,30€	41291016	28,90€	41295015	23,30€	LSAY002	21,90€	41795007	21,40€	41795008	20,90€
450	YZ450 F	05-05	41371002	52,30€	41291016	28,90€	41295015	23,30€	LSAY002	21,90€	41795007	21,40€	41795008	20,90€
450	YZ450 F	06-08	41371117	51,80€	41291016	28,90€	41295015	23,30€	LSAY002	21,90€	41795007	21,40€	41795008	20,90€



Cyl	Modèle	Année	ROULEMENTS DE BRAS OSCILLANT				KIT DE RÉPARATION DE BIELLETES			
				€ T.T.C.		€ T.T.C.		€ T.T.C.		€ T.T.C.
YAMAHA										
450	YZ450 F	09-09	41281158	85,60€	SAKY282	74,90€	41271171	114,00€	LRKY132	94,90€
450	YZ450 F	10-17	41281202	164,20€	SAKY283	74,90€	41271171	114,00€	LRKY132	94,90€
450	YZ450 F	18-22	41281202	164,20€	SAKY283	74,90€	41271171	114,00€	LRKY132	94,90€
660	YFM660 Raptor	01-05								





Cyl	Modèle	Année	JOINT AMORT. HAUT		ROUL. AMORT. HAUT		ROUL. AMORT. BAS		ROUL. AMORT. BAS		ROULETTE DE CHAÎNE 			
				€ T.T.C.		€ T.T.C.		€ T.T.C.		€ T.T.C.	Supérieure	€ T.T.C.	Inférieure	€ T.T.C.
YAMAHA														
450	YZ450 F	09-09	41371117	51,80€	41291016	28,90€	41295015	23,30€	LSAY002	21,90€	41795007	21,40€	41795008	20,90€
450	YZ450 F	10-17	41371001	52,30€	41291016	28,90€	41295015	23,30€	LSAY002	21,90€	41795007	21,40€	41795008	20,90€
450	YZ450 F	18-22	41371001	52,30€	41291016	28,90€	41295015	23,30€	LSAY002	21,90€	41795008	20,90€	41795008	20,90€
660	YFM660 Raptor	01-05			41291020	34,70€	41295027	28,90€						



Cyl	Modèle	Année	KIT ROULEMENTS ET JOINTS D'EMBIELLAGE	€ T.T.C.	KIT JOINTS DE SORTIE DE BOÎTE	€ T.T.C.
FANTIC						
125	XE 125	21-22	41241062	63,40 €	41254023	20,80 €
125	XX 125	21-22	41241062	63,40 €	41254023	20,80 €
250	XX 250	22-22	41241029	157,70 €	41254021	46,00 €
250	XXF 250	22-22			41254044	26,90 €
450	XEF 450	22-22			41254019	44,70 €
450	XXF 450	22-22			41254019	44,70 €
GAS GAS						
50	MC50	21-22	41241099	65,40 €		
65	MC65	21-22	41241103	105,00 €	41254006	20,80 €
85	MC85	21-22			41254005	22,20 €
125	EC125	03-12	41241110	81,60 €		
125	MC125	03-09	41241110	81,60 €		
125	MC125	21-22	41241097	123,50 €	41254045	22,60 €
125	SM125	03-06	41241110	81,60 €		
125	TXT125	03-03	41241111	182,20 €		
125	TXT125 Pro	04-04	41241111	182,20 €		
200	EC200	03-04	41241112	182,20 €		
200	EC200	05-07	41241115	269,50 €		
200	EC200	08-20	41241118	82,40 €		
200	EC200 Ranger	19-20	41241118	82,40 €		
250	EC250	03-07	41241115	269,50 €		
250	EC250	08-20	41241118	82,40 €		
250	EC250	21-22	41241098	262,00 €	41254001	26,60 €
250	EC250F	21-22			41254001	26,60 €
250	MC250	03-07	41241115	269,50 €		
250	MC250	08-09	41241118	82,40 €		
250	MC250	22-22			41254001	26,60 €
250	MC250F	21-22			41254001	26,60 €
250	TXT250	03-05	41241115	269,50 €		
300	EC300	03-07	41241115	269,50 €		
300	EC300	08-20	41241118	82,40 €		
300	EC300	21-22	41241098	262,00 €		
300	EC300 Ranger	19-20	41241118	82,40 €		
350	EC350F	21-22			41254001	26,60 €
350	MC350F	22-22			41254001	26,60 €
450	MC450F	21-22			41254001	26,60 €
HONDA						
50	CRF50	04-22	41241031	63,20 €		
50	XR50	00-03	41241031	63,20 €		
70	CRF70	04-13	41241031	63,20 €		
70	XR70 R	95-03	41241031	63,20 €		
80	CR80 R	85-86	41241002	119,70 €		
80	CR80 R	87-02	41241002	119,70 €		
85	CR85	03-08	41241002	119,70 €		
100	CRF100	04-13	41241032	94,50 €		
100	XR100	81-85	41241032	94,50 €		
100	XRR100	85-04	41241032	94,50 €		
110	CRF 110	13-21	41241032	94,50 €		
125	CR125 R	86-03	41241003	71,70 €	41254010	20,80 €
125	CR125 R	04-07	41241003	71,70 €	41254009	20,80 €
125	CRF125 F	14-21	41241032	94,50 €		
150	CRF150 F	03-14	41241056	86,80 €		
230	CRF230 F	04-14	41241056	86,80 €		
250	CR250 R	88-91	41241004	150,80 €	41254008	20,80 €
250	CR250 R	92-08	41241030	145,90 €	41254008	20,80 €
250	CRF250 R	04-17			41254009	20,80 €
250	CRF250 R	18-22			41254008	20,80 €
250	CRF250 RX	20-22			41254008	20,80 €
250	CRF250 X	04-15			41254009	20,80 €
300	CRF300 RX	21-22			41254008	20,80 €
400	CRF400 RX	21-22			41254008	20,80 €



Cyl	Modèle	Année	KIT ROULEMENTS ET JOINTS D'EMBIELLAGE	€ T.T.C.	KIT JOINTS DE SORTIE DE BOÎTE	€ T.T.C.
450	CRF450 R	02-22			41254008	20,80 €
450	CRF450 RX	17-22			41254008	20,80 €
450	CRF450 X	05-20			41254008	20,80 €
500	CR500 R	84-87	41241004	150,80 €		
500	CR500 R	88-02	41241004	150,80 €	41254008	20,80 €
HUSABERG						
250	FE250 4T	13-13			41254001	26,60 €
250	FE250 4T	14-14			41254003	24,10 €
250	TE250 2T	11-14	41241098	262,00 €	41254003	24,10 €
300	TE300 2T	13-14	41241098	262,00 €	41254003	24,10 €
350	FE350 4T	13-14			41254001	26,60 €
390	FE390 Enduro	10-12			41254001	26,60 €
450	FE450	09-11			41254001	26,60 €
570	FE570 Enduro	09-12			41254001	26,60 €
HUSQVARNA						
50	TC 50	19-22	41241099	65,40 €		
65	CR 65	12-14	41241102	118,70 €		
65	TC 65	17-22	41241103	105,00 €	41254006	20,80 €
85	TC 85 14/17	16-22			41254005	22,20 €
85	TC 85 16/19	14-22			41254005	22,20 €
125	CR125	99-00	41241107	114,30 €		
125	CR125	01-13	41241108	130,40 €		
125	TC125 2T	13-15	41241097	123,50 €	41254001	26,60 €
125	TC125 2T	16-22	41241097	123,50 €	41254045	22,60 €
125	TE125 2T	13-14	41241097	123,50 €		
125	TE125 2T	15-16	41241097	123,50 €	41254001	26,60 €
125	TE125 4T	10-14	41241097	123,50 €		
125	TX125 2T	17-19	41241097	123,50 €		
125	WR125	98-99	41241107	114,30 €		
125	WR125	00-13	41241108	130,40 €		
150	TE150i	20-22	41241097	123,50 €	41254045	22,60 €
250	CR250	92-98	41241109	134,10 €		
250	CR250	99-05	41241107	114,30 €		
250	FC 250	14-22			41254001	26,60 €
250	FE250	14-22			41254001	26,60 €
250	TC250	14-16	41241098	262,00 €	41254003	24,10 €
250	TC250	17-22	41241098	262,00 €	41254001	26,60 €
250	TE250	14-16	41241098	262,00 €	41254003	24,10 €
250	TE250	17-17	41241098	262,00 €	41254001	26,60 €
250	TE250i	18-22	41241098	262,00 €	41254001	26,60 €
250	WR250	98-98	41241109	134,10 €		
250	WR250	99-13	41241107	114,30 €		
300	TE300	14-16	41241098	262,00 €	41254003	24,10 €
300	TE300	17-17	41241098	262,00 €	41254001	26,60 €
300	TE300i	18-22	41241098	262,00 €	41254001	26,60 €
300	WR300	09-13	41241107	114,30 €		
350	FC 350	14-22			41254001	26,60 €
350	FE 350	14-22			41254001	26,60 €
360	WR360	98-02	41241109	134,10 €		
450	FC 450	14-22			41254001	26,60 €
450	FE 450	14-22			41254001	26,60 €
450	FS 450	15-22			41254001	26,60 €
501	FE 501	14-22			41254001	26,60 €
KAWASAKI						
60	KX60	83-99	41241006	51,80 €	41254018	20,90 €
65	KX65	00-04	41241006	51,80 €	41254018	20,90 €
65	KX65	05-22	41241003	71,70 €	41254017	20,90 €
80	KX80	89-00	41241006	51,80 €	41254018	20,90 €
85	KX85	01-04	41241006	51,80 €	41254018	20,90 €
85	KX85	05-22	41241006	51,80 €	41254017	20,90 €
125	KX125	85-87	41241007	117,30 €		
125	KX125	88-93	41241008	72,70 €		

Cyl	Modèle	Année	KIT ROULEMENTS ET JOINTS D'EMBIELLAGE	€ T.T.C.	KIT JOINTS DE SORTIE DE BOÎTE	€ T.T.C.
KAWASAKI						
125	KX125	94-08	41241008	72,70 €	41254016	22,50 €
200	KDX200	92-06	41241045	123,80 €		
250	KDX250	91-94	41241010	149,60 €	41254015	53,00 €
250	KLX250 S /SF	09-17	41241059	95,60 €		
250	KX250	87-90	41241010	149,60 €		
250	KX250	91-01	41241010	149,60 €	41254015	53,00 €
250	KX250	02-08	41241047	109,60 €	41254015	53,00 €
250	KX250 F	04-05	41241081	90,00 €	41254013	40,20 €
250	KX250 F	06-13	41241081	90,00 €	41254012	51,40 €
250	KX250 F	14-18	41241081	90,00 €	41254035	40,20 €
250	KX250 F - KX	19-22	41241081	90,00 €	41254035	40,20 €
250	KX250X Enduro (KL)	22-22	41241081	90,00 €	41254035	40,20 €
300	KLX300 R	97-02	41241059	95,60 €		
300	KLX300 R	03-07	41241059	95,60 €		
360	KVF360 Prairie 2x4	03-07	41241059	95,60 €		
450	KLX450 R	05-15			41254011	51,10 €
450	KX450 F	06-18			41254011	51,10 €
450	KX450 F - KX	19-22			41254046	26,30 €
450	KX450 X Enduro (KL)	22-22			41254046	26,30 €
500	KX500	84-87	41241011	145,90 €		
500	KX500	88-04	41241011	145,90 €	41254043	26,90 €
KTM						
50	Mini Adventure 50	98-00	41241100	37,38 €		
50	Mini Adventure 50	01-07	41241101	117,50 €		
50	Supermoto 50 SM	06-06	41241101	117,50 €		
50	SX50	03-08	41241101	117,50 €		
50	SX50	09-22	41241099	65,40 €		
50	SX50 Junior	06-07	41241101	117,50 €		
50	SX50 Junior	08-15	41241099	65,40 €		
50	SX50 Mini	19-22	41241099	65,40 €		
50	SX50 Pro Junior	97-01	41241100	37,38 €		
50	SX50 Pro Junior LC	02-06	41241101	117,50 €		
50	SX50 Pro Senior	98-99	41241100	37,38 €		
50	SX50 Pro Senior LC	02-06	41241101	117,50 €		
60	SX60	98-01	41241102	118,70 €	41254007	46,70 €
65	SX65	00-08	41241102	118,70 €	41254007	46,70 €
65	SX65	09-22	41241103	105,00 €	41254006	20,80 €
85	SX85	03-22			41254005	22,20 €
125	EGS125	98-99	41241097	123,50 €		
125	EXC125 Enduro	98-09	41241097	123,50 €		
125	SX125	98-15	41241097	123,50 €	41254001	26,60 €
125	SX125	16-22	41241097	123,50 €	41254045	22,60 €
125	XC125 W Enduro	19-19	41241097	123,50 €	41254045	22,60 €
150	EXC150 TPI Enduro	20-22	41241097	123,50 €	41254045	22,60 €
150	SX144	07-08	41241097	123,50 €	41254001	26,60 €
150	SX150	09-15	41241097	123,50 €	41254001	26,60 €
150	SX150	16-22	41241097	123,50 €	41254045	22,60 €
200	EGS200	98-99	41241097	123,50 €	41254004	34,90 €
200	EXC200 Enduro	98-05	41241097	123,50 €	41254001	26,60 €
200	SX200	00-02	41241097	123,50 €		
200	SX200	03-04	41241097	123,50 €	41254001	26,60 €
200	SX200	05-05	41241097	123,50 €		
250	EGS250	94-99			41254004	34,90 €
250	EXC250 Enduro	95-03			41254004	34,90 €
250	EXC250 Enduro	04-16	41241098	262,00 €	41254003	24,10 €
250	EXC250 Enduro	17-17	41241098	262,00 €	41254001	26,60 €
250	EXC250 Racing	04-05			41254001	26,60 €
250	EXC250 Racing	06-15	41241098	262,00 €		
250	EXC250 TPI Enduro	18-22	41241098	262,00 €	41254001	26,60 €
250	EXC250-F Enduro	07-12	41241105	343,70 €		
250	EXC250-F Enduro	17-22			41254001	26,60 €
250	Freeride	13-17	41241098	262,00 €	41254003	24,10 €







Cyl	Modèle	Année	KIT ROULEMENTS ET JOINTS D'EMBIELLAGE	€ T.T.C.	KIT JOINTS DE SORTIE DE BOÎTE	€ T.T.C.
250	Freeride F	18-20			41254001	26,60 €
250	SX250	95-02			41254004	34,90 €
250	SX250	03-03	41241098	262,00 €	41254003	24,10 €
250	SX250 2T	04-16	41241098	262,00 €	41254003	24,10 €
250	SX250 2T	17-22	41241098	262,00 €	41254001	26,60 €
250	SX250-F	05-12	41241105	343,70 €	41254001	26,60 €
250	SX250-F	13-22			41254001	26,60 €
300	EGS300	94-99			41254004	34,90 €
300	EXC300 Enduro	94-03			41254004	34,90 €
300	EXC300 Enduro	04-16	41241098	262,00 €	41254003	24,10 €
300	EXC300 Enduro	17-17	41241098	262,00 €	41254001	26,60 €
300	EXC300 TPI Enduro	18-22	41241098	262,00 €	41254001	26,60 €
350	EXC350-F	12-22			41254001	26,60 €
350	Freeride 350	12-17			41254001	26,60 €
350	SX350-F	11-22			41254001	26,60 €
360	EGS360	96-97			41254004	34,90 €
360	EXC360	96-97			41254004	34,90 €
360	SX360	96-98			41254004	34,90 €
380	EGS380	98-99			41254004	34,90 €
380	EXC380	98-02			41254004	34,90 €
380	SX380	98-02			41254004	34,90 €
400	EXC400	00-02	41241106	328,40 €	41254001	26,60 €
400	EXC400	03-06	41241106	328,40 €		
400	MXC400	00-02	41241106	328,40 €		
400	SX400 Enduro	00-00			41254001	26,60 €
400	SX400 Enduro	01-02	41241106	328,40 €	41254001	26,60 €
400	SX400 Racing (> 04/2002)	00-02	41241106	328,40 €	41254001	26,60 €
450	EXC450-F	03-07	41241106	328,40 €	41254001	26,60 €
450	EXC450-F	08-22			41254001	26,60 €
450	EXC450-R	02-07	41241106	328,40 €	41254001	26,60 €
450	EXC450-R	08-16			41254001	26,60 €
450	MXC450	03-06	41241106	328,40 €	41254001	26,60 €
450	SMR450	04-14	41241106	328,40 €	41254001	26,60 €
450	SMR450	21-21			41254001	26,60 €
450	SX450 Racing	03-06	41241106	328,40 €		
450	SX450 Racing	15-15			41254001	26,60 €
450	SX450-F	03-06	41241106	328,40 €	41254001	26,60 €
450	SX450-F	07-12			41254002	39,80 €
450	SX450-F	13-22			41254001	26,60 €
450	XC450-F	08-09			41254002	39,80 €
450	XC450-F	10-13			41254001	26,60 €
450	XC450-W /WR	09-13			41254001	26,60 €
500	EXC500-F	12-22			41254001	26,60 €
505	SX505	09-09			41254001	26,60 €
505	SX505 F Racing	08-09			41254002	39,80 €
520	EXC520 Racing 4T (> 04/2002)	01-02	41241106	328,40 €	41254001	26,60 €
520	MXC520 2T	00-02	41241106	328,40 €	41254001	26,60 €
520	MXC520 4T	01-02	41241106	328,40 €	41254001	26,60 €
520	SX520 Racing 4T (> 04/2002)	00-02	41241106	328,40 €	41254001	26,60 €
525	EXC525 Racing 4T	03-07	41241106	328,40 €	41254001	26,60 €
525	MXC525 2T	03-03	41241106	328,40 €	41254001	26,60 €
525	MXC525 4T	03-06	41241106	328,40 €	41254001	26,60 €
525	SX525 Racing 2T	03-03	41241106	328,40 €	41254001	26,60 €
525	SX525 Racing 4T	03-08	41241106	328,40 €	41254001	26,60 €
530	EXC530	08-11			41254001	26,60 €
Rieju						
250	MR250	22-22	41241118	82,40 €		
300	MR300 Ranger	22-22	41241118	82,40 €		
SUZUKI						
65	RM65	03-06	41241006	51,80 €	41254018	20,90 €
125	DR-Z 125 /L	03-15	41241036	99,60 €		
125	DR-Z 125 L	16-22	41241036	99,60 €		

PIÈCES TECHNIQUES

Cyl	Modèle	Année	KIT ROULEMENTS ET JOINTS D'EMBIELLAGE	€ T.T.C.	KIT JOINTS DE SORTIE DE BOÎTE	€ T.T.C.
SUZUKI						
125	RM125	82-88	41241015	55,79 €		
125	RM125	89-91	41241016	145,80 €		
125	RM125	92-03	41241016	145,80 €	41254029	42,70 €
125	RM125	04-13	41241016	145,80 €	41254026	20,80 €
250	DR-Z 250	01-10	41241033	106,30 €		
250	RM-Z 250	04-06	41241081	90,00 €	41254013	40,20 €
250	RM-Z 250	07-12			41254026	20,80 €
250	RM-Z 250	13-22			41254028	39,80 €
250	RM250	82-85	41241069	55,90 €		
250	RM250	86-88	41241017	132,50 €		
250	RM250	89-93	41241019	136,90 €	41254027	20,80 €
250	RM250	94-95	41241020	142,30 €	41254027	20,80 €
250	RM250	96-02	41241021	90,90 €	41254027	20,80 €
250	RM250	03-04	41241046	130,30 €	41254028	39,80 €
250	RM250	05-08			41254028	39,80 €
250	RMX250	89-94	41241091	167,10 €	41254027	20,80 €
250	RMX250	95-01	41241060	176,00 €	41254027	20,80 €
400	DR-Z 400 /S	00-09			41254025	39,80 €
400	DR-Z 400 E	00-07			41254025	39,80 €
450	RM-Z 450	05-22			41254030	42,60 €
450	RMX450 Z	10-15			41254030	42,60 €
YAMAHA						
50	PW50	80-21	41241061	37,40 €		
65	YZ 65	18-22	41241117	49,10 €	41254024	40,20 €
80	PW80	83-13	41241074	47,70 €		
80	YZ80	93-01	41241023	49,10 €		
85	YZ85 /LW	02-18	41241023	49,10 €	41254024	40,20 €
85	YZ85 /LW	19-22	41241117	49,10 €	41254024	40,20 €
125	YZ125	76-79	41241073	93,90 €		
125	YZ125	80-85	41241072	130,30 €		
125	YZ125	86-86	41241024	68,30 €		
125	YZ125	87-00	41241024	68,30 €	41254024	40,20 €
125	YZ125	01-04	41241025	130,90 €	41254024	40,20 €
125	YZ125	05-22	41241062	63,40 €	41254023	20,80 €
200	WR200 R	91-97	41241065	163,50 €		
250	TT250 R	99-07	41241033	106,30 €		
250	WR250	91-97	41241027	154,00 €	41254022	40,20 €
250	WR250	98-00	41241028	150,90 €		
250	WR250	01-02	41241029	157,70 €		
250	WR250 F	01-14			41254020	20,80 €
250	WR250 F	15-22			41254044	26,90 €
250	WR250 Z	92-97	41241027	154,00 €	41254022	40,20 €
250	WR250 Z	98-99	41241028	150,90 €		
250	WR250 Z	00-05	41241029	157,70 €		
250	YZ250	80-87	41241026	133,00 €	41254022	40,20 €
250	YZ250	88-97	41241027	154,00 €	41254022	40,20 €
250	YZ250	98-98	41241028	150,90 €	41254022	40,20 €
250	YZ250	99-00	41241028	150,90 €	41254021	46,00 €
250	YZ250	01-05	41241029	157,70 €	41254021	46,00 €
250	YZ250	06-07	41241029	157,70 €	41251029	86,30 €
250	YZ250	08-22	41241029	157,70 €	41254021	46,00 €
250	YZ250 F	01-13			41254020	20,80 €
250	YZ250 F	14-22			41254044	26,90 €
250	YZ250 X	16-19	41241029	157,70 €	41254021	46,00 €
350	TT350	86-87	41241042	105,60 €		
400	WR400 F	98-01			41254019	44,70 €
400	YZ400 F	98-99			41254019	44,70 €
426	WR426 F	01-02			41254019	44,70 €
426	YZ426 F	00-02			41254019	44,70 €
450	WR450 F	03-22			41254019	44,70 €
450	YZ450 F	03-22			41254019	44,70 €







Benjamin MELOT - DAKAR 2021

Cyl.	Modèle	Années	SPI DE FOURCHE		KIT JOINTS SPI DE FOURCHE		JOINTS SPI		KIT JOINTS SPI ET CACHE POUSSIÈRE		KIT JOINTS CACHE POUSSIÈRE	
			 ATHENA	€T.T.C.	 ALL DANGLES	€T.T.C.	 KYB	€T.T.C.	 ALL DANGLES	€T.T.C.	 ALL DANGLES	€T.T.C.
APRILIA												
350	Tuareg	86-86	455065	18,30€								
350	Tuareg	89-89	455050	12,20€								
450	RXV450	06-14	455085	34,90€								
450	SXV450	06-14	455085	34,90€								
550	SXV550	06-14	455085	34,90€								
BETA												
50	RR50 Enduro Std	12-15	455042	12,60€								
125	Evo 125 (Trial)	12-22			4155137	18,00€			4156166	38,00€	4157153	20,40€
125	RR125 Enduro	18-22			4155132	18,10€			4156147	37,40€	4157105	19,60€
200	EVO (Tial)	12-20			4155137	18,00€			4156166	38,00€	4157153	20,40€
200	RR200 Enduro	19-22			4155132	18,10€			4156147	37,40€	4157105	19,60€
250	EVO (Trial)	12-22			4155137	18,00€			4156166	38,00€	4157153	20,40€
250	EVO (Trial) 4T	12-19			4155137	18,00€			4156166	38,00€	4157153	20,40€
250	Rev3, 250	00-02	455043	11,00€								
250	RR250	05-07			4155135	18,00€			4156149	37,80€	4157138	19,40€
250	RR250 Enduro	13-15			4155132	18,10€			4156147	37,40€	4157105	19,60€
250	RR250 Enduro 2T	13-22			4155132	18,10€			4156147	37,40€	4157105	19,60€
270	Techno (Trial)	98-98	455043	11,00€								
300	300RR Enduro	13-17			4155132	18,10€			4156147	37,40€	4157105	19,60€
300	300RR Enduro 2T	13-22			4155132	18,10€			4156147	37,40€	4157105	19,60€
300	EVO (Trial)	09-22			4155137	18,00€			4156166	38,00€	4157153	20,40€
300	EVO (Trial) 4T	12-22			4155137	18,00€			4156166	38,00€	4157153	20,40€
300	XTrainer	18-22			4155123	18,00€			4156137	37,40€	4157102	19,60€
350	350RR Enduro	12-22			4155132	18,10€			4156147	37,40€	4157105	19,60€
390	RR390 Enduro	14-22			4155132	18,10€			4156147	37,40€	4157105	19,60€
400	RR400 Enduro	05-10	455101	55,70€	4155135	18,00€			4156149	37,80€	4157138	19,40€
400	RR400 Enduro	11-12			4155130	18,00€			4156145	38,20€	4157140	19,40€
400	RR400 Enduro	13-15			4156132	37,40€			4156147	37,40€	4157105	19,60€
430	RR430 Enduro	13-22			4156132	37,40€			4156147	37,40€	4157105	19,60€
450	RR450 Enduro	05-09	455141	48,70€	4155135	18,00€			4156149	37,80€	4157138	19,40€
450	RR450 Enduro	10-10			4155135	18,00€			4156149	37,80€	4157138	19,40€
450	RR450 Enduro	11-12			4155130	18,00€			4156145	38,20€	4157140	19,40€
450	RR450 Enduro	13-15			4155132	18,10€			4156147	37,40€	4157105	19,60€
480	RR480 Enduro	13-22			4155132	18,10€			4156147	37,40€	4157105	19,60€
498	RR498 Enduro	12-15			4155132	18,10€			4156147	37,40€	4157105	19,60€
520	RR520 Enduro	13-15			4155132	18,10€			4156147	37,40€	4157105	19,60€
525	RR525 Enduro	05-09	455128	59,10€	4155135	18,00€			4156149	37,80€	4157138	19,40€
525	RR525 Enduro	10-10			4155135	18,00€			4156149	37,80€	4157138	19,40€
525	RR525 Enduro	11-12			4155130	18,00€			4156145	38,20€	4157140	19,40€
BMW												
450	G450 X	08-11	455085	34,90€	4155135	18,00€			4156149	37,80€	4157138	19,40€
FANTIC												
125	XE 125	21-22	455128	59,10€	4155132	18,10€	2920013	27,25€	4156147	37,40€	4157105	19,60€
125	XX 125	21-22	455128	59,10€	4155132	18,10€	2920013	27,25€	4156147	37,40€	4157105	19,60€
250	XEF 250	21-22	455128	59,10€	4155132	18,10€			4156147	37,40€	4157105	19,60€
250	XX 250	22-22	455128	59,10€	4155132	18,10€			4156147	37,40€	4157105	19,60€
250	XXF 250	22-22	455128	59,10€	4155132	18,10€			4156147	37,40€	4157105	19,60€
450	XEF 450	22-22	455128	59,10€	4155132	18,10€			4156147	37,40€	4157105	19,60€
450	XXF 450	22-22	455128	59,10€	4155132	18,10€			4156147	37,40€	4157105	19,60€
GAS GAS												
50	MC50	21-22	455215	45,90€	4155163	24,70€			4156197	38,40€	4157146	35,20€
65	MC65	21-22	455215	45,90€	4155163	24,70€			4156197	38,40€	4157146	35,20€
85	MC85	21-22	455191	20,30€	4155114	18,00€			4156126	37,40€	4157137	19,80€
125	EC125	01-12	455085	34,90€								
125	EC125	13-14	455085	34,90€	4155135	18,00€			4156149	37,80€	4157138	19,40€
125	MC125	01-13	455085	34,90€								
125	MC125	21-22	455141	48,70€	4155159	17,20€			4156192	42,90€	4157175	-
125	TXT125	00-03	455084	11,90€								
200	EC200	01-14	455085	34,90€	4155135	18,00€			4156149	37,80€	4157138	19,40€







Cyl.	Modèle	Années	CACHE POUSSIÈRE		KIT BAGUES DE FOURCHE		KIT RÉVISION DE FOURCHE		KIT RÉVISION AMORTISSEUR	
			KYB Technical Touch	€T.T.C.	ALL BALLS Rings	€T.T.C.	KYB Technical Touch	€T.T.C.	KYB Technical Touch	€T.T.C.
APRILIA										
350	Tuareg	86-86								
350	Tuareg	89-89								
450	RXV450	06-14								
450	SXV450	06-14								
550	SXV550	06-14								
BETA										
50	RR50 Enduro Std	12-15								
125	Evo 125 (Trial)	12-22								
125	RR125 Enduro	18-22								
200	EVO (Tial)	12-20								
200	RR200 Enduro	19-22								
250	EVO (Trial)	12-22								
250	EVO (Trial) 4T	12-19								
250	Rev3, 250	00-02								
250	RR250	05-07								
250	RR250 Enduro	13-15								
250	RR250 Enduro 2T	13-22								
270	Techno (Trial)	98-98								
300	300RR Enduro	13-17								
300	300RR Enduro 2T	13-22								
300	EVO (Trial)	09-22								
300	EVO (Trial) 4T	12-22								
300	XTrainer	18-22								
350	350RR Enduro	12-22								
390	RR390 Enduro	14-22								
400	RR400 Enduro	05-10								
400	RR400 Enduro	11-12								
400	RR400 Enduro	13-15								
430	RR430 Enduro	13-22								
450	RR450 Enduro	05-09								
450	RR450 Enduro	10-10								
450	RR450 Enduro	11-12								
450	RR450 Enduro	13-15								
480	RR480 Enduro	13-22								
498	RR498 Enduro	12-15								
520	RR520 Enduro	13-15								
525	RR525 Enduro	05-09								
525	RR525 Enduro	10-10								
525	RR525 Enduro	11-12								
BMW										
450	G450 X	08-11								
FANTIC										
125	XE 125	21-22			41386126	52,90€				
125	XX 125	21-22			41386126	52,90€				
250	XEF 250	21-22			41386126	52,90€				
250	XX 250	22-22			41386126	52,90€				
250	XXF 250	22-22			41386126	52,90€				
450	XEF 450	22-22			41386126	52,90€				
450	XXF 450	22-22			41386075	33,10€				
GAS GAS										
50	MC50	21-22								
65	MC65	21-22								
85	MC85	21-22			41386136	60,20€				
125	EC125	01-12								
125	EC125	13-14								
125	MC125	01-13								
125	MC125	21-22			41386157	34,20€				
125	TXT125	00-03								
200	EC200	01-14								

Cyl.	Modèle	Années	SPI DE FOURCHE		KIT JOINTS SPI DE FOURCHE		JOINTS SPI		KIT JOINTS SPI ET CACHE POUSSIÈRE		KIT JOINTS CACHE POUSSIÈRE	
			 ATHENA	€T.T.C.	 ALL BALLS Race	€T.T.C.	 KYB Technical Touch	€T.T.C.	 ALL BALLS Race	€T.T.C.	 ALL BALLS Race	€T.T.C.
GAS GAS												
200	EC200	15-20	455141	48,70€	4155132	18,10€			4156147	37,40€	4157105	19,60€
200	EC200 Ranger	19-20									4157105	19,60€
200	TX200	97-99	455084	11,90€								
200	TXT200	02-03	455084	11,90€								
250	EC250	01-11	455085	34,90€								
250	EC250	12-12	455085	34,90€	4155131	18,00€						
250	EC250	13-14	455085	34,90€	4155135	18,00€			4156149	37,80€	4157138	19,40€
250	EC250	15-20	455141	48,70€	4155132	18,10€			4156147	37,40€	4157105	19,60€
250	EC250	21-22	455141	48,70€	4155159	17,20€			4156192	42,90€	4157175	-
250	EC250F	21-22	455141	48,70€	4155159	17,20€			4156192	42,90€	4157175	-
250	MC250	22-22	455141	48,70€	4155159	17,20€			4156192	42,90€	4157175	-
250	MC250F	21-22	455141	48,70€	4155159	17,20€			4156192	42,90€	4157175	-
250	TXT250	02-03	455084	11,90€								
270	TX270	97-99	455084	11,90€								
280	TXT280	00-01	455084	11,90€								
300	EC300	01-12	455085	34,90€								
300	EC300	13-14	455085	34,90€	4155135	18,00€			4156149	37,80€	4157138	19,40€
300	EC300	15-20	455141	48,70€	4155132	18,10€			4156147	37,40€	4157105	19,60€
300	EC300	21-22	455141	48,70€	4155159	17,20€			4156192	42,90€	4157175	-
300	TXT300	04-06	455138	22,40€								
320	TX320	97-99	455084	11,90€								
350	EC350F	21-22	455141	48,70€	4155159	17,20€			4156192	42,90€	4157175	-
350	MC350F	22-22	455141	48,70€	4155159	17,20€			4156192	42,90€	4157175	-
450	EC450 FSR	09-09			4155131	18,00€						
450	EC450 FSR	13-13			4155132	18,10€			4156147	37,40€	4157105	19,60€
450	EC450 FSR	14-14	455085	34,90€	4155135	18,00€			4156149	37,80€	4157138	19,40€
450	MC450F	21-22	455141	48,70€	4155159	17,20€			4156192	42,90€	4157175	-
HM												
50	CRE50 Baja	07-16	455138	22,40€								
50	CRE50 Enduro	98-00	455053	12,60€								
50	CRE50 Enduro	01-06	455138	22,40€								
50	CRE50 Six Compétition	07-16	455138	22,40€								
50	CRM50 Dérapage	07-16	455138	22,40€								
50	CRM50 Six Compétition	07-16	455138	22,40€								
250	CRE250 F Enduro	04-06	455076	18,00€								
450	CRE450 F Enduro	02-05	455076	18,00€	4155127	18,40€						
450	CRE450 X Enduro	04-13			4155127	18,40€						
HONDA												
70	CRF70	04-13	455080	12,60€	4155101	34,60€			4156101	73,00€	4157126	35,20€
70	XR70 R	95-96			4155101	34,60€			4156101	73,00€	4157126	35,20€
70	XR70 R	97-03	455080	12,60€	4155101	34,60€			4156101	73,00€	4157126	35,20€
80	CR80 R	84-84			4155107	18,00€						
80	CR80 R	85-86	455025	10,20€	4155107	18,00€			4156113	37,40€	4157113	37,20€
80	CR80 R	87-91	455032	13,40€	4155108	18,10€			4156115	37,40€	4157112	19,40€
80	CR80 R	92-95	455035	11,90€	4155108	18,10€			4156115	37,40€	4157112	19,40€
80	CR80 R	96-02	455042	12,60€	4155111	18,10€			4156123	37,40€	4157109	19,40€
80	CRF80	04-09	455080	12,60€	4155101	34,60€			4156101	73,00€	4157126	35,20€
80	XR80	79-90	455080	12,60€	4155101	34,60€			4156101	73,00€	4157126	35,20€
80	XRR80	85-91	455080	12,60€	4155101	34,60€			4156101	73,00€	4157126	35,20€
85	CR85	03-05	455143	33,80€	4155111	18,10€			4156123	37,40€	4157109	19,40€
85	CR85	06-08	455143	33,80€	4155111	18,10€						
100	CRF100	04-13	455080	12,60€	4155101	34,60€			4156101	73,00€	4157126	35,20€
100	XR100	81-85			4155101	34,60€						
100	XRR100	85-04	455080	12,60€	4155101	34,60€			4156101	73,00€	4157126	35,20€
110	CRF 110	13-21	455015	11,10€	4155104	18,20€			4156170	37,40€	4157156	37,10€
125	CR125 R	81-81			4155112	18,10€						
125	CR125 R	82-83			4155112	18,10€			4156124	38,20€	4157119	19,40€
125	CR125 R	84-86	455056 455093	12,60€ 32,60€	4155120	18,10€			41561331	37,40€	41571081	19,40€







Cyl.	Modèle	Années	CACHE POUSSIÈRE		KIT BAGUES DE FOURCHE		KIT RÉVISION DE FOURCHE		KIT RÉVISION AMORTISSEUR	
			KYB Technical Touch	€T.T.C.	ALL BALLS Racing	€T.T.C.	KYB Technical Touch	€T.T.C.	KYB Technical Touch	€T.T.C.
GAS GAS										
200	EC200	15-20								
200	EC200 Ranger	19-20								
200	TX200	97-99								
200	TXT200	02-03								
250	EC250	01-11								
250	EC250	12-12								
250	EC250	13-14								
250	EC250	15-20								
250	EC250	21-22				41386157	34,20€			
250	EC250F	21-22				41386157	34,20€			
250	MC250	22-22				41386157	34,20€			
250	MC250F	21-22				41386157	34,20€			
250	TXT250	02-03								
270	TX270	97-99								
280	TXT280	00-01								
300	EC300	01-12								
300	EC300	13-14								
300	EC300	15-20								
300	EC300	21-22				41386157	34,20€			
300	TXT300	04-06								
320	TX320	97-99								
350	EC350F	21-22				41386157	34,20€			
350	MC350F	22-22				41386157	34,20€			
450	EC450 FSR	09-09								
450	EC450 FSR	13-13								
450	EC450 FSR	14-14								
450	MC450F	21-22				41386157	34,20€			
HM										
50	CRE50 Baja	07-16								
50	CRE50 Enduro	98-00								
50	CRE50 Enduro	01-06								
50	CRE50 Six Compétition	07-16								
50	CRM50 Dérapage	07-16								
50	CRM50 Six Compétition	07-16								
250	CRE250 F Enduro	04-06								
450	CRE450 F Enduro	02-05								
450	CRE450 X Enduro	04-13								
HONDA										
70	CRF70	04-13								
70	XR70 R	95-96								
70	XR70 R	97-03								
80	CR80 R	84-84								
80	CR80 R	85-86								
80	CR80 R	87-91								
80	CR80 R	92-95								
80	CR80 R	96-02				41386112	96,00€			
80	CRF80	04-09								
80	XR80	79-90								
80	XRR80	85-91								
85	CR85	03-05				41386112	96,00€			
85	CR85	06-08				41386112	96,00€			
100	CRF100	04-13								
100	XR100	81-85								
100	XRR100	85-04								
110	CRF 110	13-21								
125	CR125 R	81-81								
125	CR125 R	82-83								
125	CR125 R	84-86								

Cyl.	Modèle	Années	SPI DE FOURCHE		KIT JOINTS SPI DE FOURCHE		JOINTS SPI		KIT JOINTS SPI ET CACHE POUSSIÈRE		KIT JOINTS CACHE POUSSIÈRE	
			 ATHENA	€T.T.C.	 ALL BALLS	€T.T.C.	 KYB	€T.T.C.	 ALL BALLS	€T.T.C.	 ALL BALLS	€T.T.C.
HONDA												
125	CR125 R	87-87	455056 455093	12,60€ 32,60€	4155120	18,10€			41561331	37,40€	41571081	19,40€
125	CR125 R	88-89	455056 455093	12,60€ 32,60€	4155120	18,10€			41561331	37,40€	41571081	19,40€
125	CR125 R	90-91	455059 455088	18,30€ 34,90€	4155124	18,00€			4156139	37,40€	4157101	19,60€
125	CR125 R	92-93	455055 455092	14,90€ 34,90€	4155121	34,60€			4156134	37,40€	4157108	19,40€
125	CR125 R	94-96	455057 455089	12,60€ 34,40€	4155123	18,00€			4156137	37,40€	4157102	19,60€
125	CR125 R	97-00	455086	31,50€	4155126	18,40€	2920011	18,50€	4156141	37,40€	4157103	19,40€
125	CR125 R	01-03	455086	31,50€	4155126	18,40€	2920011	18,50€	4156141	37,40€	4157103	19,40€
125	CR125 R	04-07	455086	31,50€	4155126	18,40€	2920011	18,50€	4156141	37,40€	4157103	19,40€
125	CRF125 F	14-21	455015	11,10€	4155104	18,20€			4156170	37,40€	4157156	37,10€
150	CRF150 F	03-14	455032	13,40€	4155104	18,20€			4156170	37,40€	4157134	35,20€
150	CRF150 R	07-15	455143	33,80€	4155111	18,10€			4156123	37,40€	4157109	19,40€
230	CRF230 F	03-14	455042	12,60€	4155111	18,10€			4156123	37,40€	4157109	19,40€
250	CR250 R	88-88	455056 455093	12,60€ 32,60€	4155120	18,10€			41561331	37,40€	41571081	19,40€
250	CR250 R	89-89	455059 455088	18,30€ 34,90€	4155124	18,00€			4156139	37,40€	4157101	19,60€
250	CR250 R	90-91	455059 455088	18,30€ 34,90€	4155124	18,00€			4156139	37,40€	4157101	19,60€
250	CR250 R	92-94	455055 455092	14,90€ 34,90€	4155121	34,60€			4156134	37,40€	4157108	19,40€
250	CR250 R	95-95	455057 455089	12,60€ 34,40€	4155123	18,00€			4156137	37,40€	4157102	19,60€
250	CR250 R	96-96	455086	31,50€	4155126	18,40€	2920011	18,50€	4156141	37,40€	4157103	19,40€
250	CR250 R	97-08	455076	18,00€	4155127	18,40€			4156142	37,80€	4157100	19,40€
250	CRF250 R	04-08	455122	25,60€	4155127	18,40€			4156142	37,80€	4157100	19,40€
250	CRF250 R	09-09	455122	25,60€	4155127	18,40€			4156142	37,80€	4157100	19,40€
250	CRF250 R	10-14	455123	32,00€	4155132	18,10€			4156147	37,40€	4157105	19,60€
250	CRF250 R	15-17	455073	24,50€	4155129	18,40€			4156144	37,40€	4157104	19,90€
250	CRF250 R	18-22	455073	24,50€	4155129	18,40€			4156144	37,40€	4157104	19,90€
250	CRF250 RX	20-22	455073	24,50€	4155129	18,40€			4156144	37,40€	4157104	19,90€
250	CRF250 X	04-15	455122	25,60€	4155127	18,40€			4156142	37,80€	4157100	19,40€
300	CRF300 RX	21-22	455073	24,50€	4155129	18,40€			4156144	37,40€	4157104	19,90€
400	CRF400 RX	21-22	455073	24,50€	4155129	18,40€			4156144	37,40€	4157104	19,90€
400	XR400 R	96-97	455056	12,60€	4155120	18,10€			41561331	37,40€	41571081	19,40€
400	XR400 R	98-06	455056	12,60€	4155120	18,10€			41561331	37,40€	41571081	19,40€
400	XR400 Supermotard	96-97	455056	12,60€	4155120	18,10€			41561331	37,40€	41571081	19,40€
400	XR400 Supermotard	98-06	455056	12,60€	4155120	18,10€			41561331	37,40€	41571081	19,40€
450	CR450 R	81-81	455053	12,60€	4155116	18,00€			4156128	37,40€	4157118	19,40€
450	CRF450 R	02-08	455122	25,60€	4155127	18,40€			4156142	37,80€	4157100	19,40€
450	CRF450 R	09-12	455139	33,90€	4155132	18,10€	2920014	23,75€	4156147	37,40€	4157105	19,60€
450	CRF450 R	13-13	455139	33,90€	4155149	50,50€	2920013	27,25€	4156167	73,40€	4157105	19,60€
450	CRF450 R	14-14	455139	33,90€	4155149	50,50€	2920013	27,25€	4156167	73,40€	4157105	19,60€
450	CRF450 R	15-15	455128	59,10€	4155149	50,50€	2920013	27,25€	4156167	73,40€	4157105	19,60€
450	CRF450 R	16-16	455128	59,10€	4155149	50,50€			4156167	73,40€	4157105	19,60€
450	CRF450 R	17-17	455073	24,50€	4155129	18,40€			4156167	73,40€	4157104	19,90€
450	CRF450 R	18-22	455073	24,50€	4155129	18,40€			4156144	37,40€	4157104	19,90€
450	CRF450 RX	17-22	455073	24,50€	4155129	18,40€			4156144	37,40€	4157104	19,90€
450	CRF450 X	05-18	455122	25,60€	4155127	18,40€			4156142	37,80€	4157100	19,40€
450	CRF450 X	19-20			4155127	18,40€			4156142	37,80€	4157100	19,40€
480	CR480 R	82-82			4155122	18,10€			4156136	38,20€	4157117	19,40€
480	CR480 R	83-83			4155120	18,10€			4156133	37,40€	4157108	19,40€
500	CR500 R	84-84	455056 455093	12,60€ 32,60€	4155120	18,10€			41561331	37,40€	41571081	19,40€
500	CR500 R	85-87	455056 455093	12,60€ 32,60€	4155120	18,10€			41561331	37,40€	41571081	19,40€
500	CR500 R	88-88	455056 455093	12,60€ 32,60€	4155120	18,10€			41561331	37,40€	41571081	19,40€
500	CR500 R	89-89	455059 455088	18,30€ 34,90€	4155124	18,00€			4156139	37,40€	4157101	19,60€
500	CR500 R	90-91	455059 455088	18,30€ 34,90€	4155124	18,00€			4156139	37,40€	4157101	19,60€







Cyl.	Modèle	Années	CACHE POUSSIÈRE		KIT BAGUES DE FOURCHE		KIT RÉVISION DE FOURCHE		KIT RÉVISION AMORTISSEUR	
			KYB Technical Touch	€T.T.C.	ALL BALLS Rings	€T.T.C.	KYB Technical Touch	€T.T.C.	KYB Technical Touch	€T.T.C.
HONDA										
125	CR125 R	87-87			41386085	49,10€				
125	CR125 R	88-89			41386005	47,30€				
125	CR125 R	90-91			41386006	86,40€				
125	CR125 R	92-93								
125	CR125 R	94-96			41386009	51,26€				
125	CR125 R	97-00	2920026	19,96€	41386010	47,70€	2921228	75,50€		
125	CR125 R	01-03	2920026	19,96€	41386010	47,70€	2921228	75,50€	2921916	118,75€
125	CR125 R	04-07	2920026	19,96€	41386010	47,70€	2921228	75,50€	2921911	77,75€
125	CRF125 F	14-21								
150	CRF150 F	03-14								
150	CRF150 R	07-15			41386112	96,00€				
230	CRF230 F	03-14								
250	CR250 R	88-88			41386005	47,30€				
250	CR250 R	89-89								
250	CR250 R	90-91			41386006	86,40€				
250	CR250 R	92-94								
250	CR250 R	95-95			41386014	48,90€				
250	CR250 R	96-96	2920026	19,96€	41386010	47,70€	2921228	75,50€		
250	CR250 R	97-08			41386020	41,00€				
250	CRF250 R	04-08			41386020	41,00€				
250	CRF250 R	09-09			41386080	87,20€				
250	CRF250 R	10-14			41386081	48,70€				
250	CRF250 R	15-17			41386119	62,20€				
250	CRF250 R	18-22			41386131	31,40€				
250	CRF250 RX	20-22			41386131	31,40€				
250	CRF250 X	04-15			41386020	41,00€				
300	CRF300 RX	21-22			41386131	31,40€				
400	CRF400 RX	21-22			41386131	31,40€				
400	XR400 R	96-97			41386026	95,90€				
400	XR400 R	98-06			41386057	94,00€				
400	XR400 Supermotard	96-97			41386026	95,90€				
400	XR400 Supermotard	98-06			41386057	94,00€				
450	CR450 R	81-81								
450	CRF450 R	02-08			41386020	41,00€				
450	CRF450 R	09-12	2920028	25,75€	41386075	33,10€	2921231	104,00€	2921921	77,75€
450	CRF450 R	13-13	2920028	25,75€	41386075	33,10€	2921231	104,00€	2921921	77,75€
450	CRF450 R	14-14	2920028	25,75€	41386075	33,10€	2921233	104,00€	2921921	77,75€
450	CRF450 R	15-15	2920028	25,75€	41386075	33,10€			2921921	77,75€
450	CRF450 R	16-16			41386075	33,10€				
450	CRF450 R	17-17			41386131	31,40€				
450	CRF450 R	18-22			41386131	31,40€				
450	CRF450 RX	17-22			41386131	31,40€				
450	CRF450 X	05-18			41386020	41,00€				
450	CRF450 X	19-20			41386020	41,00€				
480	CR480 R	82-82								
480	CR480 R	83-83								
500	CR500 R	84-84								
500	CR500 R	85-87			41386085	49,10€				
500	CR500 R	88-88			41386005	47,30€				
500	CR500 R	89-89								
500	CR500 R	90-91			41386006	86,40€				

Cyl.	Modèle	Années	SPI DE FOURCHE		KIT JOINTS SPI DE FOURCHE		JOINTS SPI		KIT JOINTS SPI ET CACHE POUSSIÈRE		KIT JOINTS CACHE POUSSIÈRE	
			 ATHENA	€T.T.C.	 ALL DANGLES	€T.T.C.	 KYB	€T.T.C.	 ALL DANGLES	€T.T.C.	 ALL DANGLES	€T.T.C.
HONDA												
500	CR500 R	92-94	455055 455092	14,90€ 34,90€	4155121	34,60€			4156134	37,40€	4157108	19,40€
500	CR500 R	95-95	455057 455089	12,60€ 34,40€	4155123	18,00€			4156137	37,40€	4157102	19,60€
500	CR500 R	96-02	455086	31,50€	4155126	18,40€	2920011	18,50€	4156141	37,40€	4157103	19,40€
500	XR500 R	81-82	455042	12,60€	4155111	18,10€			4156123	37,40€	4157109	19,40€
500	XR500 R	83-86	455056	12,60€	4155111	18,10€			4156133	37,40€	4157108	19,40€
500	XR500 S	79-80	455032	13,40€	4155108	18,10€			4156118	71,50€	4157132	34,50€
600	XR600 R	85-87	455056	12,60€	4155120	18,10€			41561331	37,40€	41571081	19,40€
600	XR600 R	88-90	455056	12,60€	4155120	18,10€			41561331	37,40€	41571081	19,40€
600	XR600 R [FR]	91-00	455056	12,60€	4155120	18,10€			41561331	37,40€	41571081	19,40€
650	XR650 L [US]	93-13	455056	12,60€	4155120	18,10€			41561331	37,40€	41571081	19,40€
650	XR650 R	00-07	455105	41,50€	4155125	18,20€	2920011	18,50€	4156140	71,50€	4157116	34,50€
HUSABERG												
125	TE125 2T	12-13	455128	59,10€	4155131	18,00€			4156146	37,40€	4157105	19,60€
125	TE125 2T	14-16	455141	48,70€								
250	FE250 4T	13-13	455128	59,10€	4155131	18,00€			4156146	37,40€	4157105	19,60€
250	FE250 4T	14-14	455128	59,10€	4155131	18,00€			4156146	37,40€	4157105	19,60€
250	TE250 2T	11-11	455128	59,10€	4155131	18,00€			4156146	37,40€	4157105	19,60€
250	TE250 2T	12-12	455128	59,10€	4155131	18,00€			4156146	37,40€	4157105	19,60€
250	TE250 2T	13-13	455128	59,10€	4155131	18,00€			4156146	37,40€	4157105	19,60€
250	TE250 2T	14-14	455128	59,10€	4155131	18,00€			4156146	37,40€	4157105	19,60€
300	TE300 2T	13-14	455128	59,10€	4155131	18,00€			4156146	37,40€	4157105	19,60€
350	FE350 4T	13-13	455128	59,10€	4155131	18,00€			4156146	37,40€	4157105	19,60€
350	FE350 4T	14-14	455128	59,10€	4155131	18,00€			4156146	37,40€	4157105	19,60€
350	TE350	14-14	455128	59,10€	4155131	18,00€			4156146	37,40€	4157105	19,60€
390	FE390 Enduro	10-11	455128	59,10€	4155131	18,00€			4156146	37,40€	4157105	19,60€
390	FE390 Enduro	12-12	455128	59,10€	4155131	18,00€			4156146	37,40€	4157105	19,60€
400	FE400 /S /E	00-02	455102	57,90€								
400	FE400 /S /E	03-03	455128	59,10€	4155131	18,00€			4156146	37,40€	4157105	19,60€
450	FC450	04-04	455128	59,10€	4155131	18,00€			4156146	37,40€	4157105	19,60€
450	FC450	05-06	455128	59,10€	4155131	18,00€			4156146	37,40€	4157105	19,60€
450	FE450	09-11	455128	59,10€	4155131	18,00€			4156146	37,40€	4157105	19,60€
450	FE450	12-12	455128	59,10€								
450	FE450	12-12	455128	59,10€	4155131	18,00€			4156146	37,40€	4157105	19,60€
450	FE450	13-13	455128	59,10€								
450	FE450	14-14	455128	59,10€	4155131	18,00€			4156146	37,40€	4157105	19,60€
450	FE450 E	04-04	455128	59,10€	4155131	18,00€			4156146	37,40€	4157105	19,60€
450	FE450 E	05-08	455128	59,10€	4155131	18,00€			4156146	37,40€	4157105	19,60€
450	FS450 E /C	03-04	455128	59,10€	4155131	18,00€			4156146	37,40€	4157105	19,60€
450	FS450 E /C	05-08	455128	59,10€	4155131	18,00€			4156146	37,40€	4157105	19,60€
501	FE501	13-13	455128	59,10€	4155131	18,00€			4156146	37,40€	4157105	19,60€
501	FE501	14-14	455128	59,10€	4155131	18,00€			4156146	37,40€	4157105	19,60€
550	FE550 /E	07-08	455128	59,10€	4155131	18,00€			4156146	37,40€	4157105	19,60€
570	FE570 Enduro	09-12	455128	59,10€	4155131	18,00€			4156146	37,40€	4157105	19,60€
650	FE650 E	04-04			4155131	18,00€			4156146	37,40€	4157105	19,60€
650	FE650 E	05-08			4155131	18,00€			4156146	37,40€	4157105	19,60€
650	FS650 C /E	04-04	455128	59,10€	4155131	18,00€			4156146	37,40€	4157105	19,60€
650	FS650 C /E	05-08	455128	59,10€	4155131	18,00€			4156146	37,40€	4157105	19,60€
HUSQVARNA												
50	TC 50	17-22	455215	45,90€	4155163	24,70€			4156197	38,40€	4157146	35,20€
50	TC 50 Mini	19-22	455215	45,90€	4155163	24,70€			4156197	38,40€	4157146	35,20€
65	TC 65	17-22	455215	45,90€	4155163	24,70€			4156197	38,40€	4157146	35,20€
85	TC 85	14-17	455127	47,60€	4155141	51,00€			4156126	37,40€	4157137	19,80€
85	TC 85	18-22	455191	20,30€	4155114	18,00€			4156126	37,40€	4157137	19,80€
125	CR125	92-94	455059	18,30€								
125	CR125	95-95	455069	15,00€								
125	CR125	96-96	455069	15,00€	4155135	18,00€			4156149	37,80€	4157138	19,40€
125	CR125	97-08	455085	34,90€	4155135	18,00€			4156149	37,80€	4157138	19,40€
125	CR125	09-09	455078	28,90€	4155130	18,00€	2920014	23,75€	4156145	38,20€	4157140	19,40€







Cyl.	Modèle	Années	CACHE POUSSIÈRE		KIT BAGUES DE FOURCHE		KIT RÉVISION DE FOURCHE		KIT RÉVISION AMORTISSEUR	
			KYB Technical Touch	€T.T.C.	ALL DUKES Rings	€T.T.C.	KYB Technical Touch	€T.T.C.	KYB Technical Touch	€T.T.C.
HONDA										
500	CR500 R	92-94								
500	CR500 R	95-95			41386024	58,87€				
500	CR500 R	96-02	2920026	19,96€	41386025	58,87€	2921228	75,50€	2921914	118,75€
500	XR500 R	81-82								
500	XR500 R	83-86								
500	XR500 S	79-80								
600	XR600 R	85-87								
600	XR600 R	88-90			41386026	95,90€				
600	XR600 R [FR]	91-00			41386026	95,90€				
650	XR650 L [US]	93-13			41386026	95,90€				
650	XR650 R	00-07	2920026	19,96€	41386027	74,00€	2921228	75,50€		
HUSABERG										
125	TE125 2T	12-13								
125	TE125 2T	14-16								
250	FE250 4T	13-13								
250	FE250 4T	14-14			41386122	40,80€				
250	TE250 2T	11-11			41386074	122,30€				
250	TE250 2T	12-12			41386082	93,10€				
250	TE250 2T	13-13								
250	TE250 2T	14-14			41386122	40,80€				
300	TE300 2T	13-14								
350	FE350 4T	13-13								
350	FE350 4T	14-14			41386122	40,80€				
350	TE350	14-14								
390	FE390 Enduro	10-11			41386074	122,30€				
390	FE390 Enduro	12-12								
400	FE400 /S /E	00-02								
400	FE400 /S /E	03-03			41386077	123,50€				
450	FC450	04-04			41386077	123,50€				
450	FC450	05-06			41386054	106,70€				
450	FE450	09-11			41386074	122,30€				
450	FE450	12-12								
450	FE450	12-12			41386074	122,30€				
450	FE450	13-13								
450	FE450	14-14			41386122	40,80€				
450	FE450 E	04-04			41386077	123,50€				
450	FE450 E	05-08			41386054	106,70€				
450	FS450 E /C	03-04			41386077	123,50€				
450	FS450 E /C	05-08			41386054	106,70€				
501	FE501	13-13								
501	FE501	14-14			41386122	40,80€				
550	FE550 /E	07-08								
570	FE570 Enduro	09-12								
650	FE650 E	04-04			41386077	123,50€				
650	FE650 E	05-08			41386054	106,70€				
650	FS650 C /E	04-04			41386077	123,50€				
650	FS650 C /E	05-08			41386054	106,70€				
HUSQVARNA										
50	TC 50	17-22								
50	TC 50 Mini	19-22								
65	TC 65	17-22								
85	TC 85	14-17			41386121	62,70€				
85	TC 85	18-22			41386136	60,20€				
125	CR125	92-94								
125	CR125	95-95								
125	CR125	96-96								
125	CR125	97-08								
125	CR125	09-09	2920028	25,75€			2921231	104,00€		

Cyl.	Modèle	Années	SPI DE FOURCHE		KIT JOINTS SPI DE FOURCHE		JOINTS SPI		KIT JOINTS SPI ET CACHE POUSSIÈRE		KIT JOINTS CACHE POUSSIÈRE	
			 ATHENA	€T.T.C.	 ALL DANGLES	€T.T.C.	 KYB	€T.T.C.	 ALL DANGLES	€T.T.C.	 ALL DANGLES	€T.T.C.
HUSQVARNA												
125	CR125	10-13	455102	57,90€	4155132	18,10€	2920014	23,75€	4156147	37,40€	4157105	19,60€
125	Cross Country	91-91					2920014	23,75€				
125	TC125 2T	13-13	455141	48,70€								
125	TC125 2T	14-14	455141	48,70€	4155131	18,00€			4156146	37,40€	4157105	19,60€
125	TC125 2T	15-17	455141	48,70€	4155131	18,00€			4156146	37,40€	4157105	19,60€
125	TC125 2T	18-20	455141	48,70€	4155132	18,10€			4156147	37,40€	4157105	19,60€
125	TC125 2T	21-22	455141	48,70€	4155132	18,10€			4156147	37,40€	4157105	19,60€
125	TE125 2T	13-16	455141	48,70€	4155131	18,00€			4156146	37,40€	4157105	19,60€
125	TE125 4T	10-14	455053	12,60€								
125	TX125 2T	17-19	455141	48,70€	4155132	18,10€			4156147	37,40€	4157105	19,60€
125	WR125	92-94	455059 455088	18,30€ 34,90€								
125	WR125	95-95	455069	15,00€								
125	WR125	96-08	455085	34,90€	4155135	18,00€			4156149	37,80€	4157138	19,40€
125	WR125	09-09	455078	28,90€	4155130	18,00€			4156145	38,20€	4157140	19,40€
125	WR125	10-10	455102	57,90€	4155132	18,10€			4156147	37,40€	4157105	19,60€
125	WR125	11-13	455102	57,90€	4155132	18,10€	2920014	23,75€	4156147	37,40€	4157105	19,60€
125	WRE125	94-94	455064	10,90€								
125	WRE125	95-95	455056 455093	12,60€ 32,60€								
125	WRE125	96-98	455069	15,00€								
125	WRE125	99-09	455085	34,90€								
125	WRE125	10-13	455050	12,20€								
150	TE150i	20-22	455141	48,70€	4155132	18,10€			4156147	37,40€	4157105	19,60€
250	CR250	92-94	455059 455088	18,30€ 34,90€								
250	CR250	95-95	455069	15,00€								
250	CR250	96-96	455069	15,00€	4155135	18,00€			4156149	37,80€	4157138	19,40€
250	CR250	97-98	455076	18,00€	4155127	18,40€			4156142	37,80€	4157100	19,40€
250	CR250	99-05	455085	34,90€	4155127	18,40€			4156142	37,80€	4157100	19,40€
250	FC 250	14-14	455141	48,70€	4155131	18,00€			4156146	37,40€	4157105	19,60€
250	FC 250	15-16	455141	48,70€	4155131	18,00€			4156146	37,40€	4157105	19,60€
250	FC 250	17-22	455141	48,70€	4155132	18,10€			4156147	37,40€	4157105	19,60€
250	FE250	14-14	455141	48,70€	4155131	18,00€			4156146	37,40€	4157105	19,60€
250	FE250	15-16	455141	48,70€	4155131	18,00€			4156146	37,40€	4157105	19,60€
250	FE250	17-20	455141	48,70€	4155132	18,10€			4156147	37,40€	4157105	19,60€
250	FE250	21-22	455141	48,70€	4155132	18,10€			4156147	37,40€	4157105	19,60€
250	TC250	02-07	455085	34,90€	4155135	18,00€			4156149	37,80€	4157138	19,40€
250	TC250	08-09	455078	28,90€	4155130	18,00€			4156145	38,20€	4157140	19,40€
250	TC250	10-13	455102	57,90€	4155132	18,10€	2920014	23,75€	4156147	37,40€	4157105	19,60€
250	TC250	14-14	455141	48,70€	4155131	18,00€			4156146	37,40€	4157105	19,60€
250	TC250	15-16	455141	48,70€	4155131	18,00€			4156146	37,40€	4157105	19,60€
250	TC250	17-20	455141	48,70€	4155132	18,10€			4156147	37,40€	4157105	19,60€
250	TC250	21-22	455141	48,70€	4155132	18,10€			4156147	37,40€	4157105	19,60€
250	TE250	02-07	455085	34,90€	4155135	18,00€			4156149	37,80€	4157138	19,40€
250	TE250	08-09	455078	28,90€	4155130	18,00€			4156145	38,20€	4157140	19,40€
250	TE250	10-13	455102	57,90€	4155132	18,10€	2920014	23,75€	4156147	37,40€	4157105	19,60€
250	TE250	14-14	455141	48,70€	4155131	18,00€			4156146	37,40€	4157105	19,60€
250	TE250	15-16	455141	48,70€	4155131	18,00€			4156146	37,40€	4157105	19,60€
250	TE250	17-17	455141	48,70€	4155132	18,10€			4156147	37,40€	4157105	19,60€
250	TE250i	18-22	455141	48,70€	4155132	18,10€			4156147	37,40€	4157105	19,60€
250	WR250	92-94	455059 455088	18,30€ 34,90€								
250	WR250	95-95	455069	15,00€								
250	WR250	96-97	455086	31,50€								
250	WR250	98-98	455078	28,90€	4155130	18,00€			4156145	38,20€	4157140	19,40€
250	WR250	99-09	455085	34,90€	4155135	18,00€			4156149	37,80€	4157138	19,40€
250	WR250	10-13	455102	57,90€	4155132	18,10€	2920014	23,75€	4156147	37,40€	4157105	19,60€
260	WR260	90-90	455059 455088	18,30€ 34,90€								
300	TE300	14-14	455141	48,70€	4155131	18,00€			4156146	37,40€	4157105	19,60€







Cyl.	Modèle	Années	CACHE POUSSIÈRE		KIT BAGUES DE FOURCHE		KIT RÉVISION DE FOURCHE		KIT RÉVISION AMORTISSEUR	
			KYB Technical Touch	€T.T.C.	ALL BALLS Rings	€T.T.C.	KYB Technical Touch	€T.T.C.	KYB Technical Touch	€T.T.C.
HUSQVARNA										
125	CR125	10-13	2920028	25,75€	41386068	62,70€	2921231	104,00€		
125	Cross Country	91-91	2920028	25,75€			2921231	104,00€		
125	TC125 2T	13-13			41386082	93,10€				
125	TC125 2T	14-14			41386082	93,10€				
125	TC125 2T	15-17			41386122	40,80€				
125	TC125 2T	18-20			41386128	40,90€				
125	TC125 2T	21-22			41386157	34,20€				
125	TE125 2T	13-16			41386122	40,80€				
125	TE125 4T	10-14								
125	TX125 2T	17-19			41386128	40,90€				
125	WR125	92-94								
125	WR125	95-95								
125	WR125	96-08								
125	WR125	09-09								
125	WR125	10-10			41386068	62,70€				
125	WR125	11-13	2920028	25,75€	41386068	62,70€	2921231	104,00€		
125	WRE125	94-94								
125	WRE125	95-95								
125	WRE125	96-98								
125	WRE125	99-09								
125	WRE125	10-13								
150	TE150i	20-22			41386128	40,90€				
250	CR250	92-94								
250	CR250	95-95								
250	CR250	96-96								
250	CR250	97-98								
250	CR250	99-05								
250	FC 250	14-14			41386082	93,10€				
250	FC 250	15-16			41386122	40,80€				
250	FC 250	17-22			41386128	40,90€				
250	FE250	14-14			41386082	93,10€				
250	FE250	15-16			41386122	40,80€				
250	FE250	17-20			41386128	40,90€				
250	FE250	21-22			41386157	34,20€				
250	TC250	02-07								
250	TC250	08-09								
250	TC250	10-13	2920028	25,75€	41386068	62,70€	2921231	104,00€		
250	TC250	14-14			41386082	93,10€				
250	TC250	15-16			41386122	40,80€				
250	TC250	17-20			41386128	40,90€				
250	TC250	21-22			41386157	34,20€				
250	TE250	02-07								
250	TE250	08-09								
250	TE250	10-13	2920028	25,75€	41386068	62,70€	2921231	104,00€		
250	TE250	14-14			41386082	93,10€				
250	TE250	15-16			41386122	40,80€				
250	TE250	17-17			41386128	40,90€				
250	TE250i	18-22			41386128	40,90€				
250	WR250	92-94								
250	WR250	95-95								
250	WR250	96-97								
250	WR250	98-98								
250	WR250	99-09								
250	WR250	10-13	2920028	25,75€	41386068	62,70€	2921231	104,00€		
260	WR260	90-90								
300	TE300	14-14			41386082	93,10€				

Cyl.	Modèle	Années	SPI DE FOURCHE		KIT JOINTS SPI DE FOURCHE		JOINTS SPI		KIT JOINTS SPI ET CACHE POUSSIÈRE		KIT JOINTS CACHE POUSSIÈRE	
			 ATHENA	€T.T.C.	 ALL DANGLES	€T.T.C.	 KYB Technical Touch	€T.T.C.	 ALL DANGLES	€T.T.C.	 ALL DANGLES	€T.T.C.
HUSQVARNA												
300	TE300	15-16	455141	48,70€	4155131	18,00€			4156146	37,40€	4157105	19,60€
300	TE300	17-17	455141	48,70€	4155132	18,10€			4156147	37,40€	4157105	19,60€
300	TE300i	18-22	455141	48,70€	4155132	18,10€			4156147	37,40€	4157105	19,60€
300	WR300	09-09	455078	28,90€	4155130	18,00€			4156145	38,20€	4157140	19,40€
300	WR300	10-13	455102	57,90€	4155132	18,10€	2920014	23,75€	4156147	37,40€	4157105	19,60€
310	TE310	08-09	455078	28,90€	4155130	18,00€			4156145	38,20€	4157140	19,40€
310	TE310	10-13	455102	57,90€	4155132	18,10€	2920014	23,75€	4156147	37,40€	4157105	19,60€
350	FC 350	14-14	455141	48,70€	4155131	18,00€			4156146	37,40€	4157105	19,60€
350	FC 350	15-16	455141	48,70€	4155131	18,00€			4156146	37,40€	4157105	19,60€
350	FC 350	17-20	455141	48,70€	4155132	18,10€			4156147	37,40€	4157105	19,60€
350	FC 350	21-22	455141	48,70€	4155132	18,10€			4156147	37,40€	4157105	19,60€
350	FE 350	14-14	455141	48,70€	4155131	18,00€			4156146	37,40€	4157105	19,60€
350	FE 350	15-16	455141	48,70€	4155131	18,00€			4156146	37,40€	4157105	19,60€
350	FE 350	17-22	455141	48,70€	4155132	18,10€			4156147	37,40€	4157105	19,60€
350	TE350	90-94	455059 455088	18,30€ 34,90€								
350	TE350	95-99	455069	15,00€								
360	WR360	92-94	455059 455088	18,30€ 34,90€								
360	WR360	95-96	455069	15,00€								
360	WR360	97-99	455078	28,90€	4155130	18,00€			4156145	38,20€	4157140	19,40€
360	WR360	00-02	455085	34,90€	4155135	18,00€			4156149	37,80€	4157138	19,40€
400	TE400	98-02	455085	34,90€	4155135	18,00€			4156149	37,80€	4157138	19,40€
410	TE410	96-96	455069	15,00€								
410	TE410	97-98	455078	28,90€	4155130	18,00€			4156145	38,20€	4157140	19,40€
410	TE410	99-01	455085	34,90€	4155135	18,00€			4156149	37,80€	4157138	19,40€
449	TC449	11-13	455102	57,90€	4155132	18,10€	2920014	23,75€	4156147	37,40€	4157105	19,60€
449	TE449	11-13	455102	57,90€	4155132	18,10€	2920014	23,75€	4156147	37,40€	4157105	19,60€
450	FC 450	14-14	455141	48,70€	4155131	18,00€			4156146	37,40€	4157105	19,60€
450	FC 450	15-16	455141	48,70€	4155131	18,00€			4156146	37,40€	4157105	19,60€
450	FC 450	17-20	455141	48,70€	4155132	18,10€			4156147	37,40€	4157105	19,60€
450	FC 450	21-22	455141	48,70€	4155132	18,10€			4156147	37,40€	4157105	19,60€
450	FE 450	14-14	455141	48,70€	4155131	18,00€			4156146	37,40€	4157105	19,60€
450	FE 450	15-15	455141	48,70€	4155131	18,00€			4156146	37,40€	4157105	19,60€
450	FE 450	16-16	455141	48,70€	4155132	18,10€			4156147	37,40€	4157105	19,60€
450	FE 450	17-22	455141	48,70€	4155132	18,10€			4156147	37,40€	4157105	19,60€
450	FS 450	15-16	455141	48,70€	4155132	18,10€			4156147	37,40€	4157105	19,60€
450	FS 450	17-22	455141	48,70€	4155132	18,10€			4156147	37,40€	4157105	19,60€
450	QM450	07-07										
450	TC450	02-05	455085	34,90€	4155135	18,00€			4156149	37,80€	4157138	19,40€
450	TC450	06-09	455085 455078	34,90€ 28,90€	4155130	18,00€			4156145	38,20€	4157140	19,40€
450	TC450	10-10	455102	57,90€	4155130	18,00€	2920014	23,75€	4156147	37,40€	4157105	19,60€
450	TC450	11-14	455102	57,90€	4155132	18,10€			4156147	37,40€	4157105	19,60€
450	TE450	02-05	455085	34,90€	4155135	18,00€			4156149	37,80€	4157138	19,40€
450	TE450	06-09	455085 455078	34,90€ 28,90€	4155130	18,00€			4156145	38,20€	4157140	19,40€
450	TE450	10-10	455102	57,90€	4155132	18,10€	2920014	23,75€	4156147	37,40€	4157105	19,60€
450	TE450	11-13	455102	57,90€	4155132	18,10€			4156147	37,40€	4157105	19,60€
501	FE 501	14-14	455141	48,70€	4155131	18,00€			4156146	37,40€	4157105	19,60€
501	FE 501	15-15	455141	48,70€	4155131	18,00€			4156146	37,40€	4157105	19,60€
501	FE 501	16-16	455141	48,70€	4155132	18,10€			4156147	37,40€	4157105	19,60€
501	FE 501	17-22	455141	48,70€	4155132	18,10€			4156147	37,40€	4157105	19,60€
510	SMR510	04-05	455085	34,90€	4155135	18,00€			4156149	37,80€	4157138	19,40€
510	SMR510	06-12	455085 455078	34,90€ 28,90€	4155130	18,00€			4156145	38,20€	4157140	19,40€
510	TC510	05-05	455085	34,90€	4155135	18,00€			4156149	37,80€	4157138	19,40€
510	TC510	06-12	455085 455078	34,90€ 28,90€	4155130	18,00€			4156145	38,20€	4157140	19,40€
510	TE510	04-05	455085	34,90€	4155135	18,00€			4156149	37,80€	4157138	19,40€
510	TE510	06-09	455085 455078	34,90€ 28,90€	4155130	18,00€			4156145	38,20€	4157140	19,40€







Cyl.	Modèle	Années	CACHE POUSSIÈRE		KIT BAGUES DE FOURCHE		KIT RÉVISION DE FOURCHE		KIT RÉVISION AMORTISSEUR	
			KYB Technical Touch	€T.T.C.	ALL BALLS Rings	€T.T.C.	KYB Technical Touch	€T.T.C.	KYB Technical Touch	€T.T.C.
HUSQVARNA										
300	TE300	15-16			41386122	40,80€				
300	TE300	17-17			41386128	40,90€				
300	TE300i	18-22			41386128	40,90€				
300	WR300	09-09								
300	WR300	10-13	2920028	25,75€	41386068	62,70€	2921231	104,00€		
310	TE310	08-09								
310	TE310	10-13	2920028	25,75€	41386068	62,70€	2921231	104,00€		
350	FC 350	14-14			41386082	93,10€				
350	FC 350	15-16			41386122	40,80€				
350	FC 350	17-20			41386128	40,90€				
350	FC 350	21-22			41386157	34,20€				
350	FE 350	14-14			41386082	93,10€				
350	FE 350	15-16			41386122	40,80€				
350	FE 350	17-22			41386128	40,90€				
350	TE350	90-94								
350	TE350	95-99								
360	WR360	92-94								
360	WR360	95-96								
360	WR360	97-99								
360	WR360	00-02								
400	TE400	98-02								
410	TE410	96-96								
410	TE410	97-98								
410	TE410	99-01								
449	TC449	11-13	2920028	25,75€			2921231	104,00€		
449	TE449	11-13	2920028	25,75€			2921231	104,00€		
450	FC 450	14-14			41386082	93,10€				
450	FC 450	15-16			41386122	40,80€				
450	FC 450	17-20			41386128	40,90€				
450	FC 450	21-22			41386157	34,20€				
450	FE 450	14-14			41386082	93,10€				
450	FE 450	15-15			41386122	40,80€				
450	FE 450	16-16			41386122	40,80€				
450	FE 450	17-22			41386128	40,90€				
450	FS 450	15-16			41386122	40,80€				
450	FS 450	17-22			41386128	40,90€				
450	QM450	07-07			41386128	40,90€				
450	TC450	02-05								
450	TC450	06-09								
450	TC450	10-10	2920028	25,75€	41386068	62,70€	2921231	104,00€		
450	TC450	11-14			41386068	62,70€				
450	TE450	02-05								
450	TE450	06-09								
450	TE450	10-10	2920028	25,75€	41386068	62,70€	2921231	104,00€		
450	TE450	11-13			41386068	62,70€				
501	FE 501	14-14			41386082	93,10€				
501	FE 501	15-15			41386122	40,80€				
501	FE 501	16-16			41386122	40,80€				
501	FE 501	17-22			41386128	40,90€				
510	SMR510	04-05								
510	SMR510	06-12								
510	TC510	05-05								
510	TC510	06-12								
510	TE510	04-05								
510	TE510	06-09								

Cyl.	Modèle	Années	SPI DE FOURCHE		KIT JOINTS SPI DE FOURCHE		JOINTS SPI		KIT JOINTS SPI ET CACHE POUSSIÈRE		KIT JOINTS CACHE POUSSIÈRE	
			 ATHENA	€T.T.C.		€T.T.C.		€T.T.C.		€T.T.C.		€T.T.C.
HUSQVARNA												
510	TE510	10-10	455102	57,90€	4155132	18,10€	2920014	23,75€	4156147	37,40€	4157105	19,60€
510	TE510	11-13	455102	57,90€	4155132	18,10€			4156147	37,40€	4157105	19,60€
570	TC570	01-03	455085	34,90€	4155135	18,00€			4156149	37,80€	4157138	19,40€
570	TE570	01-04	455085	34,90€	4155135	18,00€			4156149	37,80€	4157138	19,40€
610	TC610	92-94	455059 455088	18,30€ 34,90€								
610	TC610	95-96	455069	15,00€								
610	TC610	97-98	455085 455078	34,90€ 28,90€	4155130	18,00€			4156145	38,20€	4157140	19,40€
610	TC610	99-00	455085	34,90€	4155135	18,00€			4156149	37,80€	4157138	19,40€
610	TC610	01-06	455078	28,90€	4155130	18,00€			4156145	38,20€	4157140	19,40€
610	TE610	92-95	455059	18,30€								
610	TE610	96-96	455069	15,00€								
610	TE610	97-09	455085 455078	34,90€ 28,90€	4155135	18,00€			4156149	37,80€	4157138	19,40€
610	TE610 E	00-01	455085 455078	34,90€ 28,90€	4155135	18,00€			4156149	37,80€	4157138	19,40€
693	Enduro 701	16-22			4155132	18,10€			4156147	37,40€	4157105	19,60€
KAWASAKI												
60	KX60	83-99	455013	14,20€	4155103	18,40€			4156106	38,20€	4157124	37,10€
65	KX65	00-22	455026	13,40€	4155107	18,00€			4156113	37,40€	4157113	37,20€
80	KX80	89-89	455031	11,40€	4155108	18,10€			4156116	70,10€	4157121	36,40€
80	KX80	90-91	455031	11,40€	4155108	18,10€			4156115	37,40€	4157112	19,40€
80	KX80	92-97	455044	11,00€	4155112	18,10€			4156124	38,20€	4157119	19,40€
80	KX80	98-00	455035	11,90€	4155110	18,20€	2920003	24,16€	4156121	38,20€	4157110	19,60€
85	KX85	01-01	455035	11,90€	4155110	18,20€	2920003	24,16€	4156121	38,20€	4157110	19,60€
85	KX85	01-22	455035	11,90€	4155110	18,20€	2920003	24,16€	4156121	38,20€	4157110	19,60€
110	KLX110	02-21	455013	14,20€	4155103	18,40€			4156106	38,20€	4157124	37,10€
125	KDX125	88-94	455054	14,50€								
125	KLX125 C	10-16	455032	13,40€								
125	KLX125 D D-Tracker	10-14	455032	13,40€								
125	KX125	82-82	455053	12,60€	4155116	18,00€			4156128	37,40€	4157118	19,40€
125	KX125	83-85	455058	12,60€	4155122	18,10€			4156136	38,20€	4157117	19,40€
125	KX125	86-87	455058	12,60€	4155122	18,10€			4156136	38,20€	4157117	19,40€
125	KX125	88-88	455057 455089	12,60€ 34,40€	4155123	18,00€			4156138	73,00€	4157117	19,40€
125	KX125	89-89	455060	17,50€	4155125	18,20€			4156140	71,50€	4157116	34,50€
125	KX125	90-90	455052	12,20€	4155117	18,10€			4156129	37,40€	4157107	19,40€
125	KX125	91-91	455052	12,20€	4155123	18,00€			4156137	37,40€	4157102	19,60€
125	KX125	92-94	455057 455089	12,60€ 34,40€	4155123	18,00€			4156137	37,40€	4157102	19,60€
125	KX125	95-95	455057 455089	12,60€ 34,40€	4155123	18,00€			4156137	37,40€	4157102	19,60€
125	KX125	96-00	455086	31,50€	4155126	18,40€	2920011	18,50€	4156141	37,40€	4157103	19,40€
125	KX125	01-01	455086	31,50€	4155126	18,40€	2920011	18,50€	4156141	37,40€	4157103	19,40€
125	KX125	02-03	455123	32,00€	4155132	18,10€	2920012	23,75€	4156147	37,40€	4157105	19,60€
125	KX125	04-04	455123	32,00€	4155132	18,10€	2920012	23,75€	4156147	37,40€	4157105	19,60€
125	KX125	05-08	455123	32,00€	4155132	18,10€	2920014	23,75€	4156147	37,40€	4157105	19,60€
200	KDX200	92-92	455058	12,60€	4155122	18,10€			4156136	38,20€	4157117	19,40€
200	KDX200	93-94	455052	12,20€	4155117	18,10€			4156129	37,40€	4157107	19,40€
200	KDX200	95-06	455057 455089	12,60€ 34,40€	4155123	18,00€			4156138	73,00€	4157117	19,40€
250	KDX250	91-97	455057 455089	12,60€ 34,40€	4155123	18,00€			4156137	37,40€	4157102	19,60€
250	KLX250 R	93-98	455057 455089	12,60€ 34,40€	4155123	18,00€			4156137	37,40€	4157102	19,60€
250	KLX250 S /SF	09-17	455057 455089	12,60€ 34,40€	4155123	18,00€			4156137	37,40€	4157102	19,60€
250	KX250	82-82	455053	12,60€								
250	KX250	83-86	455058	12,60€								
250	KX250	87-87	455058	12,60€	4155122	18,10€			4156136	38,20€	4157117	19,40€
250	KX250	88-88	455057 455089	12,60€ 34,40€	4155123	18,00€			4156138	73,00€	4157117	19,40€
250	KX250	89-89	455060	17,50€	4155125	18,20€			4156140	71,50€	4157116	34,50€







Cyl.	Modèle	Années	CACHE POUSSIÈRE		KIT BAGUES DE FOURCHE		KIT RÉVISION DE FOURCHE		KIT RÉVISION AMORTISSEUR	
			KYB Technical Touch	€T.T.C.	ALL BALLS Rings	€T.T.C.	KYB Technical Touch	€T.T.C.	KYB Technical Touch	€T.T.C.
HUSQVARNA										
510	TE510	10-10	2920028	25,75€	41386068	62,70€	2921231	104,00€		
510	TE510	11-13			41386068	62,70€				
570	TC570	01-03								
570	TE570	01-04								
610	TC610	92-94								
610	TC610	95-96								
610	TC610	97-98								
610	TC610	99-00								
610	TC610	01-06								
610	TE610	92-95								
610	TE610	96-96								
610	TE610	97-09								
610	TE610 E	00-01								
693	Enduro 701	16-22								
KAWASAKI										
60	KX60	83-99								
65	KX65	00-22			41386001	-				
80	KX80	89-89								
80	KX80	90-91								
80	KX80	92-97								
80	KX80	98-00	2920019	25,25€	41386058	96,90€	2921225	78,76€		
85	KX85	01-01	2920019	25,25€	41386058	96,90€	2921225	78,76€		
85	KX85	01-22	2920019	25,25€	41386058	96,90€	2921225	78,76€	2921904	109,25€
110	KLX110	02-21								
125	KDX125	88-94								
125	KLX125 C	10-16								
125	KLX125 D D-Tracker	10-14								
125	KX125	82-82								
125	KX125	83-85								
125	KX125	86-87			41386048	95,90€				
125	KX125	88-88			41386048	95,90€				
125	KX125	89-89			41386071	113,50€				
125	KX125	90-90			41386070	58,87€				
125	KX125	91-91			41386069	123,60€				
125	KX125	92-94			41386069	123,60€				
125	KX125	95-95			41386069	123,60€	2921228	75,50€		
125	KX125	96-00	2920026	19,96€	41386010	47,70€	2921228	75,50€		
125	KX125	01-01	2920026	19,96€	41386010	47,70€	2921228	75,50€	2921911	77,75€
125	KX125	02-03	2920028	25,75€	41386066	89,00€	2921230	104,00€	2921911	77,75€
125	KX125	04-04	2920028	25,75€	41386067	50,20€	2921231	104,00€	2921912	77,75€
125	KX125	05-08	2920028	25,75€	41386067	50,20€	2921231	104,00€	2921912	77,75€
200	KDX200	92-92			41386048	95,90€				
200	KDX200	93-94								
200	KDX200	95-06			41386063	50,50€				
250	KDX250	91-97			41386064	96,90€				
250	KLX250 R	93-98			41386064	96,90€				
250	KLX250 S /SF	09-17			41386064	96,90€				
250	KX250	82-82								
250	KX250	83-86								
250	KX250	87-87			41386048	95,90€				
250	KX250	88-88			41386048	95,90€				
250	KX250	89-89			41386071	113,50€				

Cyl.	Modèle	Années	SPI DE FOURCHE		KIT JOINTS SPI DE FOURCHE		JOINTS SPI		KIT JOINTS SPI ET CACHE POUSSIÈRE		KIT JOINTS CACHE POUSSIÈRE	
			 ATHENA	€T.T.C.	 ALL BALLS	€T.T.C.	 KYB	€T.T.C.	 ALL BALLS	€T.T.C.	 ALL BALLS	€T.T.C.
KAWASAKI												
250	KX250	90-90	455052	12,20€	4155117	18,10€			4156129	37,40€	4157107	19,40€
250	KX250	91-91	455052	12,20€	4155123	18,00€			4156137	37,40€	4157102	19,60€
250	KX250	92-94	455057	12,60€	4155123	18,00€			4156137	37,40€	4157102	19,60€
250	KX250	95-95	455057	12,60€	4155123	18,00€			4156137	37,40€	4157102	19,60€
250	KX250	96-00	455086	31,50€	4155126	18,40€	2920011	18,50€	4156141	37,40€	4157103	19,40€
250	KX250	01-01	455086	31,50€	4155126	18,40€	2920011	18,50€	4156141	37,40€	4157103	19,40€
250	KX250	02-03	455123	32,00€	4155132	18,10€	2920012	23,75€	4156147	37,40€	4157105	19,60€
250	KX250	04-04	455123	32,00€	4155132	18,10€	2920012	23,75€	4156147	37,40€	4157105	19,60€
250	KX250	05-08	455123	32,00€	4155132	18,10€	2920014	23,75€	4156147	37,40€	4157105	19,60€
250	KX250 F	04-04	455123	32,00€	4155132	18,10€	2920012	23,75€	4156147	37,40€	4157105	19,60€
250	KX250 F	05-05	455123	32,00€	4155132	18,10€	2920014	23,75€	4156147	37,40€	4157105	19,60€
250	KX250 F	06-12	455076	18,00€	4155127	18,40€			4156142	37,80€	4157100	19,40€
250	KX250 F	13-14	455200	20,30€	4155132	18,10€			4156147	37,40€	4157105	19,60€
250	KX250 F	15-15	455200	20,30€	4155132	18,10€	2920013	27,25€	4156147	37,40€	4157105	19,60€
250	KX250 F	16-18	455200	20,30€	4155132	18,10€			4156147	37,40€	4157105	19,60€
250	KX250 F - KX	19-19	455200	20,30€	4155132	18,10€			4156147	37,40€	4157105	19,60€
250	KX250 F - KX	20-20	455200	20,30€	4155132	18,10€			4156147	37,40€	4157105	19,60€
250	KX250 F - KX	21-21	455073	24,50€	4155132	18,10€			4156147	37,40€	4157105	19,60€
250	KX250 F - KX	22-22	455073	24,50€	4155129	18,40€			4156144	37,40€	4157104	19,90€
250	KX250X Enduro (KL)	22-22	455073	24,50€	4155129	18,40€			4156144	37,40€	4157104	19,90€
300	KLX300 R	97-07	455057 455089	12,60€ 34,40€	4155123	18,00€			4156137	37,40€	4157102	19,60€
360	KVF360 Prairie 2x4	03-07			4155123	18,00€			4156137	37,40€	4157102	19,60€
450	KLX450 R	07-07	455139	33,90€	4155132	18,10€			4156147	37,40€	4157105	19,60€
450	KLX450 R	08-15	455139	33,90€	4155132	18,10€			4156147	37,40€	4157105	19,60€
450	KX450 F	06-07	455123	32,00€	4155132	18,10€	2920014	23,75€	4156147	37,40€	4157105	19,60€
450	KX450 F	08-08	455123	32,00€	4155132	18,10€	2920014	23,75€	4156147	37,40€	4157105	19,60€
450	KX450 F	09-12	455123	32,00€	4155132	18,10€	2920014	23,75€	4156147	37,40€	4157105	19,60€
450	KX450 F	13-14	455123	32,00€	4155149	50,50€	2920015	27,25€	4156167	73,40€	4157105	19,60€
450	KX450 F	15-18	455073	24,50€	4155129	18,40€			4156144	37,40€	4157104	19,90€
450	KX450 F - KX	19-22	455073	24,50€	4155129	18,40€			4156144	37,40€	4157104	19,90€
450	KX450 X Enduro (KL)	22-22	455073	24,50€	4155129	18,40€			4156144	37,40€	4157104	19,90€
500	KX500	84-87	455058	12,60€	4155122	18,10€			4156136	38,20€	4157117	19,40€
500	KX500	88-88	455057 455089	12,60€ 34,40€	4155123	18,00€			4156138	73,00€	4157117	19,40€
500	KX500	89-89	455060	17,50€	4155125	18,20€			4156140	71,50€	4157116	34,50€
500	KX500	90-90	455052	12,20€	4155117	18,10€			4156129	37,40€	4157107	19,40€
500	KX500	91-93	455057 455089	12,60€ 34,40€	4155123	18,00€			4156137	37,40€	4157102	19,60€
500	KX500	94-96	455057 455089	12,60€ 34,40€	4155123	18,00€			4156137	37,40€	4157102	19,60€
500	KX500	97-04	455086	31,50€	4155126	18,40€	2920011	18,50€	4156141	37,40€	4157103	19,40€
650	KLX650 C	93-95	455057 455089	12,60€ 34,40€	4155123	18,00€			4156137	37,40€	4157102	19,60€
650	KLX650 R	93-96	455057 455089	12,60€ 34,40€	4155123	18,00€			4156137	37,40€	4157102	19,60€
650	KLX650 R	99-01	455057 455089	12,60€ 34,40€	4155123	18,00€			4156137	37,40€	4157102	19,60€
KTM												
0	SX-E	19-22			4155163	24,70€			4156197	38,40€	4157146	35,20€
50	Mini Adventure 50	98-01			4155115	18,10€			4156127	71,50€	4157135	35,20€
50	Mini Adventure 50	02-07			4155115	18,10€			4156154	38,20€	4157142	35,20€
50	SX50	06-11	455066	7,20€	4155115	18,10€			4156154	38,20€	4157142	35,20€
50	SX50	12-16	455202	14,70€	4155141	51,00€			4156159	88,60€	4157146	35,20€
50	SX50	17-22	455215	45,90€	4155163	24,70€			4156197	38,40€	4157146	35,20€
50	SX50 Junior	06-09	455066	7,20€	4155115	18,10€			4156154	38,20€	4157142	35,20€
50	SX50 Mini	19-22	455215	45,90€	4155163	24,70€			4156197	38,40€	4157146	35,20€
50	SX50 Pro Junior	97-01	455066	7,20€	4155115	18,10€			4156127	71,50€	4157135	35,20€
50	SX50 Pro Junior LC	02-06	455066	7,20€	4155115	18,10€			4156154	38,20€	4157142	35,20€
50	SX50 Pro Senior	98-99	455066	7,20€	4155115	18,10€			4156127	71,50€	4157135	35,20€
50	SX50 Pro Senior LC	02-06	455066	7,20€	4155115	18,10€			4156154	38,20€	4157142	35,20€
50	SX50 Senior Adventure	03-07	455066	7,20€	4155115	18,10€			4156154	38,20€	4157142	35,20€







Cyl.	Modèle	Années	CACHE POUSSIÈRE		KIT BAGUES DE FOURCHE		KIT RÉVISION DE FOURCHE		KIT RÉVISION AMORTISSEUR	
			KYB Technical Touch	€T.T.C.	ALL BALLS Rings	€T.T.C.	KYB Technical Touch	€T.T.C.	KYB Technical Touch	€T.T.C.
KAWASAKI										
250	KX250	90-90			41386070	58,87€				
250	KX250	91-91			41386069	123,60€				
250	KX250	92-94			41386069	123,60€				
250	KX250	95-95			41386069	123,60€	2921228	75,50€		
250	KX250	96-00	2920026	19,96€	41386010	47,70€	2921228	75,50€		
250	KX250	01-01	2920026	19,96€	41386010	47,70€	2921228	75,50€	2921911	77,75€
250	KX250	02-03	2920028	25,75€	41386066	89,00€	2921230	104,00€	2921911	77,75€
250	KX250	04-04	2920028	25,75€	41386067	50,20€	2921231	104,00€	2921912	77,75€
250	KX250	05-08	2920028	25,75€	41386067	50,20€	2921231	104,00€	2921912	77,75€
250	KX250 F	04-04	2920028	25,75€	41386067	50,20€	2921231	104,00€	2921915	77,75€
250	KX250 F	05-05	2920028	25,75€	41386067	50,20€	2921231	104,00€	2921915	77,75€
250	KX250 F	06-12			41386015	62,70€				
250	KX250 F	13-14			41386108	48,70€				
250	KX250 F	15-15	2920028	25,75€	41386108	48,70€	2921233	104,00€		
250	KX250 F	16-18			41386108	48,70€				
250	KX250 F - KX	19-19			41386108	48,70€				
250	KX250 F - KX	20-20			41386154	38,90€				
250	KX250 F - KX	21-21			41386154	38,90€				
250	KX250 F - KX	22-22			41386135	40,80€				
250	KX250X Enduro (KL)	22-22			41386135	40,80€				
300	KLX300 R	97-07			41386064	96,90€				
360	KVF360 Prairie 2x4	03-07			41386064	96,90€				
450	KLX450 R	07-07			41386068	62,70€			2921917	77,75€
450	KLX450 R	08-15			41386068	62,70€				
450	KX450 F	06-07	2920028	25,75€	41386068	62,70€	2921231	104,00€	2921917	77,75€
450	KX450 F	08-08	2920028	25,75€	41386075	33,10€	2921231	104,00€	2921917	77,75€
450	KX450 F	09-12	2920028	25,75€	41386075	33,10€	2921231	104,00€	2921922	77,75€
450	KX450 F	13-14	2920028	25,75€	41386109	87,60€			2921922	77,75€
450	KX450 F	15-18			41386130	40,90€				
450	KX450 F - KX	19-22			41386135	40,80€				
450	KX450 X Enduro (KL)	22-22			41386135	40,80€				
500	KX500	84-87			41386048	95,90€				
500	KX500	88-88			41386048	95,90€				
500	KX500	89-89			41386071	113,50€				
500	KX500	90-90			41386070	58,87€				
500	KX500	91-93			41386069	123,60€				
500	KX500	94-96			41386039	40,90€			2921914	118,75€
500	KX500	97-04	2920026	19,96€	41386010	47,70€	2921228	75,50€	2921914	118,75€
650	KLX650 C	93-95			41386064	96,90€				
650	KLX650 R	93-96			41386064	96,90€				
650	KLX650 R	99-01								
KTM										
0	SX-E	19-22								
50	Mini Adventure 50	98-01								
50	Mini Adventure 50	02-07								
50	SX50	06-11								
50	SX50	12-16								
50	SX50	17-22								
50	SX50 Junior	06-09								
50	SX50 Mini	19-22								
50	SX50 Pro Junior	97-01								
50	SX50 Pro Junior LC	02-06								
50	SX50 Pro Senior	98-99								
50	SX50 Pro Senior LC	02-06								
50	SX50 Senior Adventure	03-07								

Cyl.	Modèle	Années	SPI DE FOURCHE		KIT JOINTS SPI DE FOURCHE		JOINTS SPI	KIT JOINTS SPI ET CACHE POUSSIÈRE		KIT JOINTS CACHE POUSSIÈRE	
			 ATHENA	€T.T.C.	 ALL BALLS Race	€T.T.C.	 KYB Technical Touch	€T.T.C.	 ALL BALLS Race	€T.T.C.	 ALL BALLS Race
KTM											
60	SX60	98-01	455066	7,20€	4155115	18,10€		4156127	71,50€	4157135	35,20€
65	SX65	00-01	455066	7,20€	4155115	18,10€		4156127	71,50€	4157135	35,20€
65	SX65	02-11	455169	17,00€	4155128	18,00€		4156143	37,40€	4157139	38,00€
65	SX65	12-16	455202	14,70€	4155141	51,00€		4156159	88,60€	4157146	35,20€
65	SX65	17-22			4155163	24,70€		4156197	38,40€	4157146	35,20€
85	SX85	03-13	455127	47,60€	4155114	18,00€		4156126	37,40€	4157137	19,80€
85	SX85	14-17	455127	47,60€	4155114	18,00€		4156126	37,40€	4157137	19,80€
85	SX85	18-22	455191	20,30€	4155114	18,00€		4156126	37,40€	4157137	19,80€
125	EGS125	86-87	455064	10,90€							
125	EGS125	88-94	455065	18,30€							
125	EGS125	95-95	455069	15,00€							
125	EGS125	96-99	455069	15,00€	4155135	18,00€		4156149	37,80€	4157138	19,40€
125	EXC125 Enduro	95-99	455069	15,00€	4155135	18,00€		4156149	37,80€	4157138	19,40€
125	EXC125 Enduro	00-01	455101	55,70€	4155114	18,00€		4156126	37,40€	4157137	19,80€
125	EXC125 Enduro	02-02	455128	59,10€				4156146	37,40€		
125	EXC125 Enduro	03-04	455128	59,10€	4155131	18,00€		4156146	37,40€	4157105	19,60€
125	EXC125 Enduro	05-09	455141	48,70€	4155131	18,00€		4156146	37,40€	4157105	19,60€
125	EXC125 Enduro	10-18	455141	48,70€							
125	EXE125 Enduro	00-01	455128	59,10€	4155114	18,00€		4156126	37,40€	4157137	19,80€
125	LC 2, 125	98-98	455069	15,00€							
125	MX125	85-86	455064	10,90€							
125	MX125	87-94	455065	18,30€							
125	SX125	93-95	455065	18,30€							
125	SX125	96-97	455065	18,30€	4155135	18,00€		4156149	37,80€	4157138	19,40€
125	SX125	98-98	455069	15,00€	4155135	18,00€		4156149	37,80€	4157138	19,40€
125	SX125	99-99	455069	15,00€	4155134	34,60€		4156148	70,20€	4157106	34,50€
125	SX125	00-01	455101	55,70€	4155114	18,00€		4156126	37,40€	4157137	19,80€
125	SX125	02-02	455128	59,10€	4155131	18,00€		4156146	37,40€	4157105	19,60€
125	SX125	03-04	455128	59,10€	4155131	18,00€		4156146	37,40€	4157105	19,60€
125	SX125	05-07	455141	48,70€	4155131	18,00€		4156146	37,40€	4157105	19,60€
125	SX125	08-12	455141	48,70€	4155131	18,00€		4156146	37,40€	4157105	19,60€
125	SX125	13-14	455141	48,70€	4155131	18,00€		4156146	37,40€	4157105	19,60€
125	SX125	15-16	455141	48,70€	4155131	18,00€		4156146	37,40€	4157105	19,60€
125	SX125	17-19	455141	48,70€	4155132	18,10€		4156147	37,40€	4157105	19,60€
125	SX125	20-21	455141	48,70€	4155132	18,10€		4156147	37,40€	4157105	19,60€
125	SX125	22-22	455141	48,70€	4155132	18,10€		4156147	37,40€	4157105	19,60€
125	XC125 W Enduro	19-19	455141	48,70€	4155132	18,10€		4156147	37,40€	4157105	19,60€
150	EXC150 TPI Enduro	20-22	455141	48,70€	4155132	18,10€		4156147	37,40€	4157105	19,60€
150	SX144	07-08	455141	48,70€	4155131	18,00€		4156146	37,40€	4157105	19,60€
150	SX150	09-11	455141	48,70€	4155131	18,00€		4156146	37,40€	4157105	19,60€
150	SX150	12-14	455141	48,70€	4155131	18,00€		4156146	37,40€	4157105	19,60€
150	SX150	15-16	455141	48,70€	4155131	18,00€		4156146	37,40€	4157105	19,60€
150	SX150	17-20	455141	48,70€	4155132	18,10€		4156147	37,40€	4157105	19,60€
150	SX150	21-22	455141	48,70€	4155132	18,10€		4156147	37,40€	4157105	19,60€
200	EGS200	98-99	455069	15,00€	4155135	18,00€		4156149	37,80€	4157138	19,40€
200	EXC200 Enduro	98-99	455069	15,00€	4155135	18,00€		4156149	37,80€	4157138	19,40€
200	EXC200 Enduro	00-01	455101	55,70€	4155114	18,00€		4156126	37,40€	4157137	19,80€
200	EXC200 Enduro	02-02	455128	59,10€	4155131	18,00€		4156146	37,40€	4157105	19,60€
200	EXC200 Enduro	03-04	455128	59,10€	4155131	18,00€		4156146	37,40€	4157105	19,60€
200	EXC200 Enduro	05-07	455141	48,70€	4155131	18,00€		4156146	37,40€	4157105	19,60€
200	EXC200 Enduro	08-08	455141	48,70€	4155131	18,00€		4156146	37,40€	4157105	19,60€
200	EXC200 Enduro	09-11	455141	48,70€	4155131	18,00€		4156146	37,40€	4157105	19,60€
200	EXC200 Enduro	12-15	455141	48,70€	4155131	18,00€		4156146	37,40€	4157105	19,60€
200	EXC200 Enduro	16-16	455141	48,70€	4155131	18,00€		4156146	37,40€	4157105	19,60€
200	SX200	00-01	455101	55,70€	4155114	18,00€		4156126	37,40€	4157137	19,80€
200	SX200	02-04	455128	59,10€	4155131	18,00€		4156146	37,40€	4157105	19,60€
200	SX200	05-06	455141	48,70€	4155131	18,00€		4156146	37,40€	4157105	19,60€
250	EGS250	92-94	455065	18,30€							
250	EGS250	95-95	455065	18,30€	4155135	18,00€		4156149	37,80€	4157138	19,40€







Cyl.	Modèle	Années	CACHE POUSSIÈRE		KIT BAGUES DE FOURCHE		KIT RÉVISION DE FOURCHE		KIT RÉVISION AMORTISSEUR	
			KYB Technical Touch	€T.T.C.	ALL BALLS Rings	€T.T.C.	KYB Technical Touch	€T.T.C.	KYB Technical Touch	€T.T.C.
KTM										
60	SX60	98-01								
65	SX65	00-01								
65	SX65	02-11								
65	SX65	12-16								
65	SX65	17-22								
85	SX85	03-13			41386052	98,90€				
85	SX85	14-17			41386121	62,70€				
85	SX85	18-22			41386136	60,20€				
125	EGS125	86-87								
125	EGS125	88-94								
125	EGS125	95-95								
125	EGS125	96-99								
125	EXC125 Enduro	95-99								
125	EXC125 Enduro	00-01			41386053	107,70€				
125	EXC125 Enduro	02-02								
125	EXC125 Enduro	03-04			41386077	123,50€				
125	EXC125 Enduro	05-09			41386054	106,70€				
125	EXC125 Enduro	10-18								
125	EXE125 Enduro	00-01								
125	LC 2, 125	98-98								
125	MX125	85-86								
125	MX125	87-94								
125	SX125	93-95								
125	SX125	96-97								
125	SX125	98-98								
125	SX125	99-99								
125	SX125	00-01			41386053	107,70€				
125	SX125	02-02								
125	SX125	03-04			41386077	123,50€				
125	SX125	05-07			41386054	106,70€				
125	SX125	08-12			41386073	119,90€				
125	SX125	13-14			41386082	93,10€				
125	SX125	15-16			41386122	40,80€				
125	SX125	17-19			41386128	40,90€				
125	SX125	20-21			41386157	34,20€				
125	SX125	22-22			41386128	40,90€				
125	XC125 W Enduro	19-19			41386128	40,90€				
150	EXC150 TPI Enduro	20-22			41386128	40,90€				
150	SX144	07-08			41386073	119,90€				
150	SX150	09-11			41386073	119,90€				
150	SX150	12-14			41386082	93,10€				
150	SX150	15-16			41386122	40,80€				
150	SX150	17-20			41386128	40,90€				
150	SX150	21-22			41386157	34,20€				
200	EGS200	98-99								
200	EXC200 Enduro	98-99								
200	EXC200 Enduro	00-01			41386053	107,70€				
200	EXC200 Enduro	02-02								
200	EXC200 Enduro	03-04			41386077	123,50€				
200	EXC200 Enduro	05-07			41386054	106,70€				
200	EXC200 Enduro	08-08			41386073	119,90€				
200	EXC200 Enduro	09-11			41386054	106,70€				
200	EXC200 Enduro	12-15			41386074	122,30€				
200	EXC200 Enduro	16-16			41386128	40,90€				
200	SX200	00-01			41386053	107,70€				
200	SX200	02-04			41386077	123,50€				
200	SX200	05-06								
250	EGS250	92-94								
250	EGS250	95-95								

Cyl.	Modèle	Années	SPI DE FOURCHE		KIT JOINTS SPI DE FOURCHE		JOINTS SPI		KIT JOINTS SPI ET CACHE POUSSIÈRE		KIT JOINTS CACHE POUSSIÈRE	
			 ATHENA	€T.T.C.	 ALL DANGLES Racing	€T.T.C.	 KYB Technical Touch	€T.T.C.	 ALL DANGLES Racing	€T.T.C.	 ALL DANGLES Racing	€T.T.C.
KTM												
250	EGS250	96-96	455069 455077	15,00€ 20,10€	4155135	18,00€			4156149	37,80€	4157138	19,40€
250	EGS250	97-97	455069 455077	15,00€ 20,10€	4155130	18,00€			4156145	38,20€	4157140	19,40€
250	EGS250	98-99	455077	20,10€	4155134	34,60€			4156148	70,20€	4157106	34,50€
250	EXC250 Enduro	95-96	455065	18,30€	4155135	18,00€			4156149	37,80€	4157138	19,40€
250	EXC250 Enduro	97-97	455069 455077	15,00€ 20,10€	4155130	18,00€			4156145	38,20€	4157140	19,40€
250	EXC250 Enduro	98-99	455077	20,10€	4155134	34,60€			4156148	70,20€	4157106	34,50€
250	EXC250 Enduro	00-01	455101	55,70€	4155114	18,00€			4156126	37,40€	4157137	19,80€
250	EXC250 Enduro	02-02	455128	59,10€	4155131	18,00€			4156146	37,40€	4157105	19,60€
250	EXC250 Enduro	03-04	455128	59,10€	4155131	18,00€			4156146	37,40€	4157105	19,60€
250	EXC250 Enduro	05-05	455141	48,70€	4155131	18,00€			4156146	37,40€	4157105	19,60€
250	EXC250 Enduro	06-07	455141	48,70€	4155131	18,00€			4156146	37,40€	4157105	19,60€
250	EXC250 Enduro	08-08	455141	48,70€	4155131	18,00€			4156146	37,40€	4157105	19,60€
250	EXC250 Enduro	09-11	455141	48,70€	4155131	18,00€			4156146	37,40€	4157105	19,60€
250	EXC250 Enduro	12-15	455141	48,70€	4155131	18,00€			4156146	37,40€	4157105	19,60€
250	EXC250 Enduro	16-16	455141	48,70€	4155131	18,00€			4156146	37,40€	4157105	19,60€
250	EXC250 Enduro	17-17	455141	48,70€	4155132	18,10€			4156147	37,40€	4157105	19,60€
250	EXC250 Racing	02-02	455128	59,10€								
250	EXC250 Racing	03-03	455128	59,10€								
250	EXC250 Racing	04-04	455128	59,10€	4155131	18,00€			4156146	37,40€	4157105	19,60€
250	EXC250 Racing	05-05	455141	48,70€	4155131	18,00€			4156146	37,40€	4157105	19,60€
250	EXC250 Racing	06-07	455141	48,70€	4155131	18,00€			4156146	37,40€	4157105	19,60€
250	EXC250 Racing	08-08	455141	48,70€	4155131	18,00€			4156146	37,40€	4157105	19,60€
250	EXC250 Racing	09-11	455141	48,70€	4155131	18,00€			4156146	37,40€	4157105	19,60€
250	EXC250 Racing	12-15	455141	48,70€	4155131	18,00€			4156146	37,40€	4157105	19,60€
250	EXC250 TPI Enduro	18-22	455141	48,70€	4155132	18,10€			4156147	37,40€	4157105	19,60€
250	EXC250-F Enduro	07-07	455141	48,70€	4155131	18,00€			4156146	37,40€	4157105	19,60€
250	EXC250-F Enduro	08-08	455141	48,70€	4155131	18,00€			4156146	37,40€	4157105	19,60€
250	EXC250-F Enduro	09-11	455141	48,70€	4155131	18,00€			4156146	37,40€	4157105	19,60€
250	EXC250-F Enduro	12-15	455141	48,70€	4155131	18,00€			4156146	37,40€	4157105	19,60€
250	EXC250-F Enduro	16-16	455141	48,70€	4155131	18,00€			4156146	37,40€	4157105	19,60€
250	EXC250-F Enduro	17-22	455141	48,70€	4155132	18,10€			4156147	37,40€	4157105	19,60€
250	EXE250 Enduro	04-04	455128	59,10€								
250	EXE250 Enduro	05-14	455141	48,70€								
250	Freeride	13-17	455127	47,60€	4155114	18,00€			4156126	37,40€	4157137	19,80€
250	Freeride F	18-20	455127	47,60€	4155114	18,00€			4156126	37,40€	4157137	19,80€
250	MX250	92-93	455065	18,30€								
250	MX250	94-94	455077	20,10€								
250	SX250	95-96	455077	20,10€	4155135	18,00€			4156149	37,80€	4157138	19,40€
250	SX250	97-97	455077	20,10€	4155130	18,00€			4156145	38,20€	4157140	19,40€
250	SX250	98-99	455077	20,10€	4155134	34,60€			4156148	70,20€	4157106	34,50€
250	SX250	00-01	455128	59,10€	4155114	18,00€			4156126	37,40€	4157137	19,80€
250	SX250	02-03	455128	59,10€	4155131	18,00€			4156146	37,40€	4157105	19,60€
250	SX250 2T	04-04	455128	59,10€	4155131	18,00€			4156146	37,40€	4157105	19,60€
250	SX250 2T	05-07	455141	48,70€	4155131	18,00€			4156146	37,40€	4157105	19,60€
250	SX250 2T	08-11	455141	48,70€	4155131	18,00€			4156146	37,40€	4157105	19,60€
250	SX250 2T	12-14	455141	48,70€	4155131	18,00€			4156146	37,40€	4157105	19,60€
250	SX250 2T	15-16	455141	48,70€	4155131	18,00€			4156146	37,40€	4157105	19,60€
250	SX250 2T	17-20	455141	48,70€	4155132	18,10€			4156147	37,40€	4157105	19,60€
250	SX250 2T	21-22	455141	48,70€	4155132	18,10€			4156147	37,40€	4157105	19,60€
250	SX250-F	05-07	455141	48,70€	4155131	18,00€			4156146	37,40€	4157105	19,60€
250	SX250-F	08-11	455141	48,70€	4155131	18,00€			4156146	37,40€	4157105	19,60€
250	SX250-F	12-14	455141	48,70€	4155131	18,00€			4156146	37,40€	4157105	19,60€
250	SX250-F	15-16	455141	48,70€	4155131	18,00€			4156146	37,40€	4157105	19,60€
250	SX250-F	17-20	455141	48,70€	4155132	18,10€			4156147	37,40€	4157105	19,60€
250	SX250-F	21-22	455141	48,70€	4155132	18,10€			4156147	37,40€	4157105	19,60€
300	EGS300	92-94	455065	18,30€								
300	EGS300	95-96	455065	18,30€	4155135	18,00€			4156149	37,80€	4157138	19,40€







Cyl.	Modèle	Années	CACHE POUSSIÈRE		KIT BAGUES DE FOURCHE		KIT RÉVISION DE FOURCHE		KIT RÉVISION AMORTISSEUR	
			KYB Technical Touch	€T.T.C.	ALL BALLS Racing	€T.T.C.	KYB Technical Touch	€T.T.C.	KYB Technical Touch	€T.T.C.
KTM										
250	EGS250	96-96								
250	EGS250	97-97								
250	EGS250	98-99								
250	EXC250 Enduro	95-96								
250	EXC250 Enduro	97-97								
250	EXC250 Enduro	98-99								
250	EXC250 Enduro	00-01			41386053	107,70€				
250	EXC250 Enduro	02-02								
250	EXC250 Enduro	03-04			41386077	123,50€				
250	EXC250 Enduro	05-05			41386077	123,50€				
250	EXC250 Enduro	06-07			41386054	106,70€				
250	EXC250 Enduro	08-08			41386073	119,90€				
250	EXC250 Enduro	09-11			41386054	106,70€				
250	EXC250 Enduro	12-15			41386074	122,30€				
250	EXC250 Enduro	16-16			41386128	40,90€				
250	EXC250 Enduro	17-17			41386128	40,90€				
250	EXC250 Racing	02-02								
250	EXC250 Racing	03-03			41386077	123,50€				
250	EXC250 Racing	04-04			41386077	123,50€				
250	EXC250 Racing	05-05			41386077	123,50€				
250	EXC250 Racing	06-07			41386054	106,70€				
250	EXC250 Racing	08-08			41386073	119,90€				
250	EXC250 Racing	09-11			41386054	106,70€				
250	EXC250 Racing	12-15			41386074	122,30€				
250	EXC250 TPI Enduro	18-22			41386128	40,90€				
250	EXC250-F Enduro	07-07			41386054	106,70€				
250	EXC250-F Enduro	08-08			41386073	119,90€				
250	EXC250-F Enduro	09-11			41386054	106,70€				
250	EXC250-F Enduro	12-15			41386074	122,30€				
250	EXC250-F Enduro	16-16								
250	EXC250-F Enduro	17-22			41386128	40,90€				
250	EXE250 Enduro	04-04								
250	EXE250 Enduro	05-14								
250	Freeride	13-17								
250	Freeride F	18-20			41386136	60,20€				
250	MX250	92-93								
250	MX250	94-94								
250	SX250	95-96								
250	SX250	97-97								
250	SX250	98-99								
250	SX250	00-01								
250	SX250	02-03								
250	SX250 2T	04-04			41386077	123,50€				
250	SX250 2T	05-07			41386054	106,70€				
250	SX250 2T	08-11			41386073	119,90€				
250	SX250 2T	12-14			41386082	93,10€				
250	SX250 2T	15-16			41386122	40,80€				
250	SX250 2T	17-20			41386128	40,90€				
250	SX250 2T	21-22			41386157	34,20€				
250	SX250-F	05-07			41386054	106,70€				
250	SX250-F	08-11			41386073	119,90€				
250	SX250-F	12-14			41386082	93,10€				
250	SX250-F	15-16			41386122	40,80€				
250	SX250-F	17-20			41386128	40,90€				
250	SX250-F	21-22			41386157	34,20€				
300	EGS300	92-94								
300	EGS300	95-96								

Cyl.	Modèle	Années	SPI DE FOURCHE		KIT JOINTS SPI DE FOURCHE		JOINTS SPI		KIT JOINTS SPI ET CACHE POUSSIÈRE		KIT JOINTS CACHE POUSSIÈRE	
			 ATHENA	€T.T.C.	 ALL DANGLES Racing	€T.T.C.	 KYB Technical Touch	€T.T.C.	 ALL DANGLES Racing	€T.T.C.	 ALL DANGLES Racing	€T.T.C.
KTM												
300	EGS300	97-97	455065	18,30€	4155130	18,00€			4156145	38,20€	4157140	19,40€
300	EGS300	98-99	455077	20,10€	4155134	34,60€			4156148	70,20€	4157106	34,50€
300	EXC300 Enduro	94-94	455065	18,30€								
300	EXC300 Enduro	95-96	455065	18,30€	4155135	18,00€			4156149	37,80€	4157138	19,40€
300	EXC300 Enduro	97-97	455078	28,90€	4155130	18,00€			4156145	38,20€	4157140	19,40€
300	EXC300 Enduro	98-99	455077	20,10€	4155134	34,60€			4156148	70,20€	4157106	34,50€
300	EXC300 Enduro	00-01	455101	55,70€	4155114	18,00€			4156126	37,40€	4157137	19,80€
300	EXC300 Enduro	02-02	455128	59,10€	4155131	18,00€			4156146	37,40€	4157105	19,60€
300	EXC300 Enduro	03-04	455128	59,10€	4155131	18,00€			4156146	37,40€	4157105	19,60€
300	EXC300 Enduro	05-05	455141	48,70€	4155131	18,00€			4156146	37,40€	4157105	19,60€
300	EXC300 Enduro	06-11	455141	48,70€	4155131	18,00€			4156146	37,40€	4157105	19,60€
300	EXC300 Enduro	12-15	455141	48,70€	4155131	18,00€			4156146	37,40€	4157105	19,60€
300	EXC300 Enduro	16-16	455141	48,70€	4155131	18,00€			4156146	37,40€	4157105	19,60€
300	EXC300 Enduro	17-17	455141	48,70€	4155132	18,10€			4156147	37,40€	4157105	19,60€
300	EXC300 TPI Enduro	18-22	455141	48,70€	4155132	18,10€			4156147	37,40€	4157105	19,60€
300	SX300	93-95	455065	18,30€								
350	EXC350-F	12-15	455141	48,70€	4155131	18,00€			4156146	37,40€	4157105	19,60€
350	EXC350-F	16-19	455141	48,70€	4155131	18,00€			4156146	37,40€	4157105	19,60€
350	EXC350-F	20-22	455141	48,70€	4155132	18,10€			4156147	37,40€	4157105	19,60€
350	Freeride 350	12-17	455127	47,60€	4155114	18,00€			4156126	37,40€	4157137	19,80€
350	SX350-F	11-11	455141	48,70€	4155131	18,00€			4156146	37,40€	4157105	19,60€
350	SX350-F	12-14	455141	48,70€	4155131	18,00€			4156146	37,40€	4157105	19,60€
350	SX350-F	15-16	455141	48,70€	4155131	18,00€			4156146	37,40€	4157105	19,60€
350	SX350-F	17-20	455141	48,70€	4155132	18,10€			4156147	37,40€	4157105	19,60€
350	SX350-F	21-22	455141	48,70€	4155132	18,10€			4156147	37,40€	4157105	19,60€
360	EGS360	96-96	455077	20,10€	4155135	18,00€			4156149	37,80€	4157138	19,40€
360	EGS360	97-97	455077	20,10€	4155130	18,00€			4156145	38,20€	4157140	19,40€
360	EXC360	96-96	455077	20,10€	4155135	18,00€			4156149	37,80€	4157138	19,40€
360	EXC360	97-97	455077	20,10€	4155130	18,00€			4156145	38,20€	4157140	19,40€
360	SX360	96-96	455077	20,10€	4155135	18,00€			4156149	37,80€	4157138	19,40€
360	SX360	97-97	455077	20,10€	4155130	18,00€			4156145	38,20€	4157140	19,40€
360	SX360	98-98	455077	20,10€								
380	EGS380	98-99	455077	20,10€	4155134	34,60€			4156148	70,20€	4157106	34,50€
380	EXC380	98-99	455077	20,10€	4155134	34,60€			4156148	70,20€	4157106	34,50€
380	EXC380	00-02	455101	55,70€	4155114	18,00€			4156126	37,40€	4157137	19,80€
380	SX380	98-99	455077	20,10€	4155134	34,60€			4156148	70,20€	4157106	34,50€
380	SX380	00-02	455102	57,90€	4155114	18,00€			4156126	37,40€	4157137	19,80€
400	EXC400	00-01	455101	55,70€	4155114	18,00€			4156126	37,40€	4157137	19,80€
400	EXC400	02-02	455128	59,10€	4155131	18,00€			4156146	37,40€	4157105	19,60€
400	EXC400	03-04	455128	59,10€	4155131	18,00€			4156146	37,40€	4157105	19,60€
400	EXC400	05-06	455141	48,70€	4155131	18,00€			4156146	37,40€	4157105	19,60€
400	EXC400	07-10	455141	48,70€	4155131	18,00€			4156146	37,40€	4157105	19,60€
400	EXC400	11-14	455141	48,70€	4155131	18,00€			4156146	37,40€	4157105	19,60€
400	MXC400	00-00			4155114	18,00€			4156126	37,40€	4157137	19,80€
400	MXC400	01-02			4155114	18,00€			4156126	37,40€	4157137	19,80€
400	SC400	99-99	455077	20,10€	4155114	18,00€			4156126	37,40€	4157137	19,80€
400	SC400	00-00	455101	55,70€	4155114	18,00€			4156126	37,40€	4157137	19,80€
400	SX400 Enduro	00-01	455101	55,70€	4155114	18,00€			4156126	37,40€	4157137	19,80€
400	SX400 Enduro	02-02	455128	59,10€	4155131	18,00€			4156146	37,40€	4157105	19,60€
400	SX400 Racing (> 04/2002)	00-01	455101	55,70€	4155114	18,00€			4156126	37,40€	4157137	19,80€
400	SX400 Racing	02-02	455128	59,10€	4155131	18,00€			4156146	37,40€	4157105	19,60€
400	SXC400 Tiainen Replica	99-00			4155114	18,00€			4156126	37,40€	4157137	19,80€
440	EXC440	94-95			4155135	18,00€			4156149	37,80€	4157138	19,40€
450	EXC450-F	03-04	455128	59,10€	4155131	18,00€			4156146	37,40€	4157105	19,60€
450	EXC450-F	05-06	455141	48,70€	4155131	18,00€			4156146	37,40€	4157105	19,60€
450	EXC450-F	07-12	455141	48,70€	4155131	18,00€			4156146	37,40€	4157105	19,60€
450	EXC450-F	13-16	455141	48,70€	4155131	18,00€			4156146	37,40€	4157105	19,60€
450	EXC450-F	17-22	455141	48,70€	4155132	18,10€			4156147	37,40€	4157105	19,60€
450	EXC450-R	02-03	455128	59,10€	4155131	18,00€			4156146	37,40€	4157105	19,60€







Cyl.	Modèle	Années	CACHE POUSSIÈRE		KIT BAGUES DE FOURCHE		KIT RÉVISION DE FOURCHE		KIT RÉVISION AMORTISSEUR	
			KYB Technical Touch	€T.T.C.	ALL BALLS Racing	€T.T.C.	KYB Technical Touch	€T.T.C.	KYB Technical Touch	€T.T.C.
KTM										
300	EGS300	97-97								
300	EGS300	98-99								
300	EXC300 Enduro	94-94								
300	EXC300 Enduro	95-96								
300	EXC300 Enduro	97-97								
300	EXC300 Enduro	98-99								
300	EXC300 Enduro	00-01			41386053	107,70€				
300	EXC300 Enduro	02-02								
300	EXC300 Enduro	03-04			41386077	123,50€				
300	EXC300 Enduro	05-05			41386077	123,50€				
300	EXC300 Enduro	06-11			41386054	106,70€				
300	EXC300 Enduro	12-15			41386074	122,30€				
300	EXC300 Enduro	16-16			41386128	40,90€				
300	EXC300 Enduro	17-17			41386128	40,90€				
300	EXC300 TPI Enduro	18-22			41386128	40,90€				
300	SX300	93-95								
350	EXC350-F	12-15			41386074	122,30€				
350	EXC350-F	16-19			41386128	40,90€				
350	EXC350-F	20-22			41386128	40,90€				
350	Freeride 350	12-17			41386121	62,70€				
350	SX350-F	11-11			41386073	119,90€				
350	SX350-F	12-14			41386082	93,10€				
350	SX350-F	15-16			41386122	40,80€				
350	SX350-F	17-20			41386128	40,90€				
350	SX350-F	21-22			41386157	34,20€				
360	EGS360	96-96								
360	EGS360	97-97								
360	EXC360	96-96								
360	EXC360	97-97								
360	SX360	96-96								
360	SX360	97-97								
360	SX360	98-98								
380	EGS380	98-99								
380	EXC380	98-99								
380	EXC380	00-02			41386053	107,70€				
380	SX380	98-99								
380	SX380	00-02			41386053	107,70€				
400	EXC400	00-01			41386053	107,70€				
400	EXC400	02-02			41386053	107,70€				
400	EXC400	03-04								
400	EXC400	05-06								
400	EXC400	07-10			41386054	106,70€				
400	EXC400	11-14								
400	MXC400	00-00								
400	MXC400	01-02			41386053	107,70€				
400	SC400	99-99								
400	SC400	00-00								
400	SX400 Enduro	00-01			41386053	107,70€				
400	SX400 Enduro	02-02			41386055	98,90€				
400	SX400 Racing (> 04/2002)	00-01			41386053	107,70€				
400	SX400 Racing	02-02			41386055	98,90€				
400	SXC400 Tiainen Replica	99-00								
440	EXC440	94-95								
450	EXC450-F	03-04			41386077	123,50€				
450	EXC450-F	05-06								
450	EXC450-F	07-12			41386074	122,30€				
450	EXC450-F	13-16								
450	EXC450-F	17-22			41386128	40,90€				
450	EXC450-R	02-03								

Cyl.	Modèle	Années	SPI DE FOURCHE		KIT JOINTS SPI DE FOURCHE		JOINTS SPI	KIT JOINTS SPI ET CACHE POUSSIÈRE		KIT JOINTS CACHE POUSSIÈRE	
			 ATHENA	€T.T.C.	 ALL DANGLES	€T.T.C.	 KYB Technical Touch	€T.T.C.	 ALL DANGLES	€T.T.C.	 ALL DANGLES
KTM											
450	EXC450-R	04-08	455141	48,70€	4155131	18,00€		4156146	37,40€	4157105	19,60€
450	EXC450-R	09-11	455141	48,70€	4155131	18,00€		4156146	37,40€	4157105	19,60€
450	EXC450-R	12-16	455141	48,70€	4155131	18,00€		4156146	37,40€	4157105	19,60€
450	MXC450	03-04	455128	59,10€	4155131	18,00€		4156146	37,40€	4157105	19,60€
450	MXC450	05-05	455141	48,70€	4155131	18,00€		4156146	37,40€	4157105	19,60€
450	MXC450	06-06	455141	48,70€	4155131	18,00€		4156146	37,40€	4157105	19,60€
450	SMR450	04-07	455141	48,70€	4155131	18,00€		4156146	37,40€	4157105	19,60€
450	SMR450	08-14	455141	48,70€	4155131	18,00€		4156146	37,40€	4157105	19,60€
450	SMR450	21-21	455141	48,70€	4155132	18,10€		4156147	37,40€	4157105	19,60€
450	SX450 Racing	03-04	455128	59,10€	4155131	18,00€		4156146	37,40€	4157105	19,60€
450	SX450 Racing	05-15	455141	48,70€	4155131	18,00€		4156146	37,40€	4157105	19,60€
450	SX450-F	03-06	455128	59,10€	4155131	18,00€		4156146	37,40€	4157105	19,60€
450	SX450-F	07-07	455141	48,70€	4155131	18,00€		4156146	37,40€	4157105	19,60€
450	SX450-F	08-11	455141	48,70€	4155131	18,00€		4156146	37,40€	4157105	19,60€
450	SX450-F	12-14	455141	48,70€	4155131	18,00€		4156146	37,40€	4157105	19,60€
450	SX450-F	15-16	455141	48,70€	4155131	18,00€		4156146	37,40€	4157105	19,60€
450	SX450-F	17-20	455141	48,70€	4155132	18,10€		4156147	37,40€	4157105	19,60€
450	SX450-F	21-22	455141	48,70€	4155132	18,10€		4156147	37,40€	4157105	19,60€
450	SXS450-F	07-08			4155131	18,00€		4156146	37,40€	4157105	19,60€
450	XC450 ATV	09-13	455141	48,70€							
450	XC450-F	08-08	455141	48,70€	4155131	18,00€		4156146	37,40€	4157105	19,60€
450	XC450-F	09-13	455141	48,70€	4155131	18,00€		4156146	37,40€	4157105	19,60€
450	XC450-W /WR	08-08			4155131	18,00€		4156146	37,40€	4157105	19,60€
450	XC450-W /WR	09-11			4155131	18,00€		4156146	37,40€	4157105	19,60€
450	XC450-W /WR	12-13			4155131	18,00€		4156146	37,40€	4157105	19,60€
500	EXC500-F	12-16	455141	48,70€	4155131	18,00€		4156146	37,40€	4157105	19,60€
500	EXC500-F	17-22	455141	48,70€	4155132	18,10€		4156147	37,40€	4157105	19,60€
500	GS500 4T	82-83	455050	12,20€							
500	MX500	88-93	455065	18,30€							
505	SX505	09-13	455141	48,70€	4155131	18,00€		4156146	37,40€	4157105	19,60€
505	SX505 F Racing	07-07	455141	48,70€	4155131	18,00€		4156146	37,40€	4157105	19,60€
505	SX505 F Racing	08-08	455141	48,70€	4155131	18,00€		4156146	37,40€	4157105	19,60€
505	SX505 F Racing	09-11	455141	48,70€	4155131	18,00€		4156146	37,40€	4157105	19,60€
505	SX505 F Racing (US)	07-11	455141	48,70€	4155131	18,00€		4156146	37,40€	4157105	19,60€
505	XC505-F	09-13	455141	48,70€	4155131	18,00€		4156146	37,40€	4157105	19,60€
520	EXC520 Racing	99-99	455077	20,10€							
520	EXC520 Racing 4T (> 04/2002)	01-01	455101	55,70€	4155114	18,00€		4156126	37,40€	4157137	19,80€
520	EXC520 Racing 4T	02-02	455128	59,10€	4155131	18,00€		4156146	37,40€	4157105	19,60€
520	MXC520 2T	00-00	455101	55,70€	4155114	18,00€		4156126	37,40€	4157137	19,80€
520	MXC520 2T	01-02	455101	55,70€	4155114	18,00€		4156126	37,40€	4157137	19,80€
520	MXC520 4T	01-02	455101	55,70€	4155114	18,00€		4156126	37,40€	4157137	19,80€
520	SX520 Racing	99-99	455077	20,10€	4155130	18,00€		4156145	38,20€	4157140	19,40€
520	SX520 Racing 4T (> 04/2002)	01-02	455101	55,70€	4155114	18,00€		4156126	37,40€	4157137	19,80€
520	SX520 Racing 4T (05/2002 >)	02-02	455101	55,70€	4155114	18,00€		4156126	37,40€	4157137	19,80€
525	EXC525 Racing 4T	03-03	455128	59,10€	4155131	18,00€		4156146	37,40€	4157105	19,60€
525	EXC525 Racing 4T	04-07	455141	48,70€	4155131	18,00€		4156146	37,40€	4157105	19,60€
525	MXC525 2T	03-03	455128	59,10€	4155131	18,00€		4156146	37,40€	4157105	19,60€
525	MXC525 4T	03-04	455128	59,10€	4155131	18,00€		4156146	37,40€	4157105	19,60€
525	MXC525 4T	05-06	455141	48,70€	4155131	18,00€		4156146	37,40€	4157105	19,60€
525	SX525 Racing 4T	03-04	455128	59,10€	4155131	18,00€		4156146	37,40€	4157105	19,60€
525	SX525 Racing 4T	05-07	455141	48,70€	4155131	18,00€		4156146	37,40€	4157105	19,60€
525	SX525 Racing 4T	08-08	455141	48,70€	4155131	18,00€		4156146	37,40€	4157105	19,60€
530	EXC530	08-09	455141	48,70€	4155131	18,00€		4156146	37,40€	4157105	19,60€
530	EXC530	10-11	455141	48,70€	4155131	18,00€		4156146	37,40€	4157105	19,60€
530	SX530 Racing	08-08	455141	48,70€	4155131	18,00€		4156146	37,40€	4157105	19,60€
560	SMR560	06-07	455141	48,70€	4155131	18,00€		4156146	37,40€	4157105	19,60€
600	DUKE 600	93-93	455065	18,30€							
600	EGS600 LC4 Enduro	91-93	455065	18,30€							
600	LC4 MX	90-95	455065	18,30€							







Cyl.	Modèle	Années	CACHE POUSSIÈRE		KIT BAGUES DE FOURCHE		KIT RÉVISION DE FOURCHE		KIT RÉVISION AMORTISSEUR	
			 <small>Technical Touch</small>	€T.T.C.	 <small>Racing</small>	€T.T.C.	 <small>Technical Touch</small>	€T.T.C.	 <small>Technical Touch</small>	€T.T.C.
KTM										
450	EXC450-R	04-08								
450	EXC450-R	09-11			41386074	122,30€				
450	EXC450-R	12-16								
450	MXC450	03-04			41386077	123,50€				
450	MXC450	05-05			41386054	106,70€				
450	MXC450	06-06								
450	SMR450	04-07			41386054	106,70€				
450	SMR450	08-14								
450	SMR450	21-21			41386157	34,20€				
450	SX450 Racing	03-04								
450	SX450 Racing	05-15								
450	SX450-F	03-06								
450	SX450-F	07-07			41386054	106,70€				
450	SX450-F	08-11			41386073	119,90€				
450	SX450-F	12-14			41386082	93,10€				
450	SX450-F	15-16			41386122	40,80€				
450	SX450-F	17-20			41386128	40,90€				
450	SX450-F	21-22			41386157	34,20€				
450	SXS450-F	07-08								
450	XC450 ATV	09-13								
450	XC450-F	08-08			41386073	119,90€				
450	XC450-F	09-13								
450	XC450-W /WR	08-08			41386074	122,30€				
450	XC450-W /WR	09-11			41386054	106,70€				
450	XC450-W /WR	12-13			41386074	122,30€				
500	EXC500-F	12-16								
500	EXC500-F	17-22			41386128	40,90€				
500	GS500 4T	82-83								
500	MX500	88-93								
505	SX505	09-13								
505	SX505 F Racing	07-07								
505	SX505 F Racing	08-08			41386073	119,90€				
505	SX505 F Racing	09-11								
505	SX505 F Racing (US)	07-11								
505	XC505-F	09-13								
520	EXC520 Racing	99-99								
520	EXC520 Racing 4T (> 04/2002)	01-01			41386053	107,70€				
520	EXC520 Racing 4T	02-02			41386053	107,70€				
520	MXC520 2T	00-00								
520	MXC520 2T	01-02			41386053	107,70€				
520	MXC520 4T	01-02			41386053	107,70€				
520	SX520 Racing	99-99								
520	SX520 Racing 4T (> 04/2002)	01-02			41386053	107,70€				
520	SX520 Racing 4T (05/2002 >)	02-02			41386055	98,90€				
525	EXC525 Racing 4T	03-03			41386053	107,70€				
525	EXC525 Racing 4T	04-07			41386054	106,70€				
525	MXC525 2T	03-03								
525	MXC525 4T	03-04								
525	MXC525 4T	05-06								
525	SX525 Racing 4T	03-04			41386077	123,50€				
525	SX525 Racing 4T	05-07			41386054	106,70€				
525	SX525 Racing 4T	08-08								
530	EXC530	08-09								
530	EXC530	10-11			41386074	122,30€				
530	SX530 Racing	08-08								
560	SMR560	06-07			41386054	106,70€				
600	DUKE 600	93-93								
600	EGS600 LC4 Enduro	91-93								
600	LC4 MX	90-95								

Cyl.	Modèle	Années	SPI DE FOURCHE		KIT JOINTS SPI DE FOURCHE		JOINTS SPI		KIT JOINTS SPI ET CACHE POUSSIÈRE		KIT JOINTS CACHE POUSSIÈRE	
			 ATHENA	€T.T.C.	 ALL DANGLES	€T.T.C.	 KYB	€T.T.C.	 ALL DANGLES	€T.T.C.	 ALL DANGLES	€T.T.C.
KTM												
600	LC4 MX	96-99	455077	20,10€								
620	EXC620 LC4	94-95	455065	18,30€								
620	EXC620 LC4	96-99	455077	20,10€								
690	Enduro 690	08-10	455128	59,10€	4155131	18,00€			4156146	37,40€	4157105	19,60€
690	Enduro 690	11-15	455128	59,10€	4155131	18,00€			4156146	37,40€	4157105	19,60€
690	Enduro 690 R	09-10	455128	59,10€	4155131	18,00€			4156146	37,40€	4157105	19,60€
690	Enduro 690 R	11-14	455128	59,10€	4155131	18,00€			4156146	37,40€	4157105	19,60€
690	Enduro 690 R	15-21	455128	59,10€	4155132	18,10€			4156147	37,40€	4157105	19,60€
MONTESA												
250	Cota 315R 250	97-00			4155137	18,00€						
250	Cota 4RT 250	05-13			4155113	18,00€			4156125	37,40€	4157111	36,40€
POLARIS												
400	Scrambler 4x4 400	00-02	455054	14,50€								
400	Scrambler 4x4 400 L	95-97	455054	14,50€								
400	Sport 400 L	94-94	455054	14,50€								
Rieju												
250	MR250	22-22			4155132	18,10€			4156147	37,40€	4157105	19,60€
300	MR300	21-22			4155132	18,10€			4156147	37,40€	4157105	19,60€
SHERCO												
50	SE 0.5 50	13-16			4155111	18,10€			4156123	37,40€	4157109	19,40€
125	SE 125-R	18-22			4155132	18,10€			4156147	37,40€	4157105	19,60€
125	ST 1.25 125	09-11			4155137	18,00€			4156166	38,00€	4157153	20,40€
125	ST 1.25 125	12-17			4155147	27,20€			4156165	46,60€	4157152	20,00€
125	ST 125	18-18			4155147	27,20€			4156165	46,60€	4157152	20,00€
125	ST 125	19-22			4155149	50,50€			4156165	46,60€	4157105	19,60€
125	TY 125 Classic	19-21			4155161	18,10€						
125	X-Ride 125	11-19			4155161	18,10€						
200	Sherco 2.0 200	03-06			4155137	18,00€			4156166	38,00€	4157153	20,40€
250	Enduro 2.5 i 250	08-11			4155125	18,20€			4156150	37,40€	4157103	19,40€
250	SC250	19-19			4155149	50,50€			4156167	73,40€	4157105	19,60€
250	SCF250	19-19			4155149	50,50€			4156167	73,40€	4157105	19,60€
250	SE 2.5i-F 250	09-11			4155125	18,20€			4156150	37,40€	4157103	19,40€
250	SE 2.5i-F 250	12-13	455102	57,90€	4155132	18,10€			4156147	37,40€	4157105	19,60€
250	SE-R 250	14-22	455102	57,90€	4155132	18,10€			4156147	37,40€	4157105	19,60€
250	SE-R 250 Factory	14-18	455102	57,90€	4155132	18,10€			4156147	37,40€	4157105	19,60€
250	SE-R 250 Factory	19-22	455102	57,90€	4155149	50,50€			4156167	73,40€	4157105	19,60€
250	SEF-R 2,5 250 4T	14-17	455102	57,90€	4155132	18,10€			4156147	37,40€	4157105	19,60€
250	SEF-R 2,5 250 4T	18-22			4155132	18,10€			4156147	37,40€	4157105	19,60€
250	SEF-R 2,5 250 4T Factory	14-18	455102	57,90€	4155132	18,10€			4156147	37,40€	4157105	19,60€
250	SEF-R 2,5 250 4T Factory	19-22			4155149	50,50€			4156167	73,40€	4157105	19,60€
250	Sherco 2.5 250	98-08			4155137	18,00€			4156166	38,00€	4157153	20,40€
250	Sherco 2.5 250	13-14			4155147	27,20€			4156165	46,60€	4157152	20,00€
250	ST 2.5 250	09-11			4155137	18,00€			4156166	38,00€	4157153	20,40€
250	ST 2.5 250	12-17			4155147	27,20€			4156165	46,60€	4157152	20,00€
250	ST 250	18-18			4155147	27,20€			4156165	46,60€	4157152	20,00€
250	ST 250	19-22			4155149	50,50€			4156165	46,60€	4157105	19,60€
290	Sherco 2.9 290	01-08			4155137	18,00€			4156166	38,00€	4157153	20,40€
290	Sherco 2.9 290	13-15			4155147	27,20€			4156165	46,60€	4157152	20,00€
290	ST 2.9 290	09-11			4155137	18,00€			4156166	38,00€	4157153	20,40€
290	ST 2.9 290	12-13			4155147	27,20€						
290	X-Ride 290	11-19			4155161	18,10€						
300	SC300	19-19			4155149	50,50€			4156167	73,40€	4157105	19,60€
300	SCF300	19-19			4155149	50,50€			4156167	73,40€	4157105	19,60€
300	SE-R 3,0	13-16	455102	57,90€	4155132	18,10€			4156147	37,40€	4157105	19,60€
300	SE-R 3,0 i	10-11			4155125	18,20€			4156150	37,40€	4157103	19,40€
300	SE-R 3,0 i	12-12	455102	57,90€	4155132	18,10€			4156147	37,40€	4157105	19,60€
300	SE-R 300	15-22	455102	57,90€	4155132	18,10€			4156147	37,40€	4157105	19,60€
300	SE-R 300 Factory	13-18	455102	57,90€	4155132	18,10€			4156147	37,40€	4157105	19,60€
300	SE-R 300 Factory	19-22	455102	57,90€	4155149	50,50€			4156167	73,40€	4157105	19,60€







Cyl.	Modèle	Années	CACHE POUSSIÈRE		KIT BAGUES DE FOURCHE		KIT RÉVISION DE FOURCHE		KIT RÉVISION AMORTISSEUR	
			KYB Technical Touch	€T.T.C.	ALL BALLS Racing	€T.T.C.	KYB Technical Touch	€T.T.C.	KYB Technical Touch	€T.T.C.
KTM										
600	LC4 MX	96-99								
620	EXC620 LC4	94-95								
620	EXC620 LC4	96-99								
690	Enduro 690	08-10			41386074	122,30€				
690	Enduro 690	11-15								
690	Enduro 690 R	09-10			41386074	122,30€				
690	Enduro 690 R	11-14								
690	Enduro 690 R	15-21								
MONTESA										
250	Cota 315R 250	97-00								
250	Cota 4RT 250	05-13								
POLARIS										
400	Scrambler 4x4 400	00-02								
400	Scrambler 4x4 400 L	95-97								
400	Sport 400 L	94-94								
Rieju										
250	MR250	22-22								
300	MR300	21-22								
SHERCO										
50	SE 0.5 50	13-16								
125	SE 125-R	18-22								
125	ST 1.25 125	09-11								
125	ST 1.25 125	12-17								
125	ST 125	18-18								
125	ST 125	19-22								
125	TY 125 Classic	19-21								
125	X-Ride 125	11-19								
200	Sherco 2.0 200	03-06								
250	Enduro 2.5 i 250	08-11								
250	SC250	19-19								
250	SCF250	19-19								
250	SE 2.5i-F 250	09-11								
250	SE 2.5i-F 250	12-13								
250	SE-R 250	14-22								
250	SE-R 250 Factory	14-18								
250	SE-R 250 Factory	19-22								
250	SEF-R 2,5 250 4T	14-17								
250	SEF-R 2,5 250 4T	18-22								
250	SEF-R 2,5 250 4T Factory	14-18								
250	SEF-R 2,5 250 4T Factory	19-22								
250	Sherco 2.5 250	98-08								
250	Sherco 2.5 250	13-14								
250	ST 2.5 250	09-11								
250	ST 2.5 250	12-17								
250	ST 250	18-18								
250	ST 250	19-22								
290	Sherco 2.9 290	01-08								
290	Sherco 2.9 290	13-15								
290	ST 2.9 290	09-11								
290	ST 2.9 290	12-13								
290	X-Ride 290	11-19								
300	SC300	19-19								
300	SCF300	19-19								
300	SE-R 3,0	13-16								
300	SE-R 3,0 i	10-11								
300	SE-R 3,0 i	12-12								
300	SE-R 300	15-22								
300	SE-R 300 Factory	13-18								
300	SE-R 300 Factory	19-22								

Cyl.	Modèle	Années	SPI DE FOURCHE		KIT JOINTS SPI DE FOURCHE		JOINTS SPI		KIT JOINTS SPI ET CACHE POUSSIÈRE		KIT JOINTS CACHE POUSSIÈRE	
			 ATHENA	€T.T.C.	 ALL DANGLES	€T.T.C.	 KYB	€T.T.C.	 ALL DANGLES	€T.T.C.	 ALL DANGLES	€T.T.C.
SHERCO												
300	SEF-R 300 4T	14-18	455102	57,90€	4155132	18,10€			4156147	37,40€	4157105	19,60€
300	SEF-R 300 4T	19-22			4155132	18,10€			4156147	37,40€	4157105	19,60€
300	SEF-R 300 4T Factory	14-18	455102	57,90€	4155132	18,10€			4156147	37,40€	4157105	19,60€
300	SEF-R 300 4T Factory	19-22			4155149	50,50€			4156167	73,40€	4157105	19,60€
300	ST 3,0 Factory	14-16			4155147	27,20€			4156165	46,60€	4157152	20,00€
300	ST 3.0 2T	13-17			4155147	27,20€			4156165	46,60€	4157152	20,00€
300	ST 3.0R 2T	13-14			4155147	27,20€			4156165	46,60€	4157152	20,00€
300	ST 300	18-18			4155147	27,20€			4156165	46,60€	4157152	20,00€
300	ST 300	19-22			4155149	50,50€			4156165	46,60€	4157105	19,60€
320	Sherco 3.2 320	03-08			4155147	27,20€						
320	ST 3.2-F 320	09-13			4155137	18,00€			4156166	38,00€	4157153	20,40€
450	Enduro 4.5i 450	04-08			4155125	18,20€			4156150	37,40€	4157103	19,40€
450	SCF450	19-19			4155149	50,50€			4156167	73,40€	4157105	19,60€
450	SE 4.5i-F 450	09-11			4155125	18,20€			4156150	37,40€	4157103	19,40€
450	SE 4.5i-F 450	12-13			4155132	18,10€			4156147	37,40€	4157105	19,60€
450	SEF-R 450	17-18	455102	57,90€	4155132	18,10€			4156147	37,40€	4157105	19,60€
450	SEF-R 450	19-21			4155132	18,10€			4156147	37,40€	4157105	19,60€
450	SEF-R 450 Factory	16-21	455102	57,90€	4155132	18,10€			4156147	37,40€	4157105	19,60€
450	SM 4.5i-F 450	09-11			4155125	18,20€			4156150	37,40€	4157103	19,40€
450	SM 4.5i-F 450	12-13			4155132	18,10€			4156147	37,40€	4157105	19,60€
450	Supermotard 4.5i 450	05-08			4155125	18,20€			4156150	37,40€	4157103	19,40€
500	SCF500	19-19			4155149	50,50€			4156167	73,40€	4157105	19,60€
500	SEF-R 500	20-21			4155132	18,10€			4156147	37,40€	4157105	19,60€
500	SEF-R 500 Factory	20-21	455102	57,90€	4155149	50,50€			4156167	73,40€	4157105	19,60€
510	Enduro 5.1i 510	06-08			4155125	18,20€			4156150	37,40€	4157103	19,40€
510	SE 5.1i-F 510	09-11			4155125	18,20€			4156150	37,40€	4157103	19,40€
510	SM 5.1i-F 510	09-11			4155125	18,20€			4156150	37,40€	4157103	19,40€
510	SM 5.1i-F 510	12-13			4155132	18,10€			4156147	37,40€	4157105	19,60€
510	Supermotard 5.1i 510	07-08			4155125	18,20€			4156150	37,40€	4157103	19,40€
SUZUKI												
50	JR 80	01-01			4155100	18,10€			4156100	37,40€	4157133	37,10€
65	RM65	03-06	455026	13,40€	4155107	18,00€			4156113	37,40€	4157113	37,20€
80	RM80	80-85	455013	14,20€	4155103	18,40€			4156106	38,20€	4157124	37,10€
80	RM80	86-88	455025	10,20€	4155107	18,00€			4156113	37,40€	4157113	37,20€
80	RM80	89-90	455025	10,20€	4155108	18,10€			4156115	37,40€	4157112	19,40€
80	RM80	91-01	455032	13,40€	4155108	18,10€			4156115	37,40€	4157112	19,40€
85	RM85 / L	02-22	455042	12,60€	4155111	18,10€			4156123	37,40€	4157109	19,40€
110	DRZ110	01-07	455013	14,20€	4155103	18,40€			4156106	38,20€	4157124	37,10€
125	DR-Z 125 /L	03-15	455013	14,20€	4155103	18,40€						
125	DR-Z 125 L	16-22	455013	14,20€	4155103	18,40€						
125	RM125	75-75	455032	13,40€	4155108	18,10€			4156117	36,70€	4157130	36,40€
125	RM125	76-76	455032	13,40€	4155108	18,10€						
125	RM125	77-78	455035 455091	11,90€ 27,20€	4155110	18,20€						
125	RM125	79-82	455044	11,00€	4155112	18,10€			4156124	38,20€	4157119	19,40€
125	RM125	83-83	455044	11,00€	4155117	18,10€			4156124	38,20€	4157119	19,40€
125	RM125	84-87	455058	12,60€	4155122	18,10€			4156136	38,20€	4157117	19,40€
125	RM125	88-88	455057 455089	12,60€ 34,40€	4155123	18,00€			4156138	73,00€	4157117	19,40€
125	RM125	89-89	455105	41,50€	4155125	18,20€			4156140	71,50€	4157116	34,50€
125	RM125	90-90	455052	12,20€	4155117	18,10€			4156129	37,40€	4157107	19,40€
125	RM125	91-91	455059 455088	18,30€ 34,90€	4155124	18,00€			4156139	37,40€	4157101	19,60€
125	RM125	92-93	455059 455088	18,30€ 34,90€	4155124	18,00€			4156139	37,40€	4157101	19,60€
125	RM125	94-95	455059 455088	18,30€ 34,90€	4155124	18,00€			4156139	37,40€	4157101	19,60€
125	RM125	96-97	455073	24,50€	4155129	18,40€			4156144	37,40€	4157104	19,90€
125	RM125	98-98	455073	24,50€	4155129	18,40€			4156144	37,40€	4157104	19,90€
125	RM125	99-99	455073	24,50€	4155129	18,40€			4156144	37,40€	4157104	19,90€
125	RM125	00-00	455073	24,50€	4155129	18,40€			4156144	37,40€	4157104	19,90€







Cyl.	Modèle	Années	CACHE POUSSIÈRE		KIT BAGUES DE FOURCHE		KIT RÉVISION DE FOURCHE		KIT RÉVISION AMORTISSEUR	
			KYB Technical Touch	€T.T.C.	ALL BALLS Rings	€T.T.C.	KYB Technical Touch	€T.T.C.	KYB Technical Touch	€T.T.C.
SHERCO										
300	SEF-R 300 4T	14-18								
300	SEF-R 300 4T	19-22								
300	SEF-R 300 4T Factory	14-18								
300	SEF-R 300 4T Factory	19-22								
300	ST 3,0 Factory	14-16								
300	ST 3.0 2T	13-17								
300	ST 3.0R 2T	13-14								
300	ST 300	18-18								
300	ST 300	19-22								
320	Sherco 3.2 320	03-08								
320	ST 3.2-F 320	09-13								
450	Enduro 4.5i 450	04-08								
450	SCF450	19-19								
450	SE 4.5i-F 450	09-11								
450	SE 4.5i-F 450	12-13								
450	SEF-R 450	17-18								
450	SEF-R 450	19-21								
450	SEF-R 450 Factory	16-21								
450	SM 4.5i-F 450	09-11								
450	SM 4.5i-F 450	12-13								
450	Supermotard 4.5i 450	05-08								
500	SCF500	19-19								
500	SEF-R 500	20-21								
500	SEF-R 500 Factory	20-21								
510	Enduro 5.1i 510	06-08								
510	SE 5.1i-F 510	09-11								
510	SM 5.1i-F 510	09-11								
510	SM 5.1i-F 510	12-13								
510	Supermotard 5.1i 510	07-08								
SUZUKI										
50	JR 80	01-01								
65	RM65	03-06								
80	RM80	80-85								
80	RM80	86-88								
80	RM80	89-90								
80	RM80	91-01								
85	RM85 / L	02-22			41386112	96,00€				
110	DRZ110	01-07								
125	DR-Z 125 /L	03-15								
125	DR-Z 125 L	16-22								
125	RM125	75-75								
125	RM125	76-76								
125	RM125	77-78								
125	RM125	79-82								
125	RM125	83-83								
125	RM125	84-87			41386014	48,90€				
125	RM125	88-88			41386014	48,90€				
125	RM125	89-89			41386071	113,50€				
125	RM125	90-90			41386078	47,60€				
125	RM125	91-91			41386006	86,40€				
125	RM125	92-93			41386030	96,90€				
125	RM125	94-95								
125	RM125	96-97								
125	RM125	98-98			41386042	89,00€				
125	RM125	99-99								
125	RM125	00-00			41386040	89,00€				

Cyl.	Modèle	Années	SPI DE FOURCHE		KIT JOINTS SPI DE FOURCHE		JOINTS SPI		KIT JOINTS SPI ET CACHE POUSSIÈRE		KIT JOINTS CACHE POUSSIÈRE	
			 ATHENA	€T.T.C.	 ALL DANGLES	€T.T.C.	 KYB	€T.T.C.	 ALL DANGLES	€T.T.C.	 ALL DANGLES	€T.T.C.
SUZUKI												
125	RM125	01-01	455076	18,00€	4155127	18,40€			4156142	37,80€	4157100	19,40€
125	RM125	02-03	455076	18,00€	4155127	18,40€			4156142	37,80€	4157100	19,40€
125	RM125	04-04	455076	18,00€	4155127	18,40€			4156142	37,80€	4157100	19,40€
125	RM125	05-13	455076	18,00€	4155127	18,40€			4156142	37,80€	4157100	19,40€
250	DR-Z 250	01-07	455056 455093	12,60€ 32,60€	4155120	18,10€			41561331	37,40€	41571081	19,40€
250	DR-Z 250	08-10	455056 455093	12,60€ 32,60€	4155120	18,10€			41561331	37,40€	41571081	19,40€
250	RM-Z 250	04-04	455123	32,00€	4155132	18,10€	2920012	23,75€	4156147	37,40€	4157105	19,60€
250	RM-Z 250	05-06	455123	32,00€	4155132	18,10€	2920014	23,75€	4156147	37,40€	4157105	19,60€
250	RM-Z 250	07-12	455076	18,00€	4155127	18,40€			4156142	37,80€	4157100	19,40€
250	RM-Z 250	13-15	455200	20,30€	4155132	18,10€			4156147	37,40€	4157105	19,60€
250	RM-Z 250	16-18	455200	20,30€	4155132	18,10€			4156147	37,40€	4157105	19,60€
250	RM-Z 250	19-22	455200	20,30€	4155132	18,10€			4156147	37,40€	4157105	19,60€
250	RM250	76-78	455036	11,90€	4155110	18,20€						
250	RM250	79-82	455044	11,00€	4155112	18,10€			4156124	38,20€	4157119	19,40€
250	RM250	83-87	455058	12,60€	4155122	18,10€			4156136	38,20€	4157117	19,40€
250	RM250	88-88	455057 455089	12,60€ 34,40€	4155123	18,00€			4156138	73,00€	4157117	19,40€
250	RM250	89-89	455052	12,20€	4155117	18,10€			4156129	37,40€	4157107	19,40€
250	RM250	90-90	455052	12,20€	4155117	18,10€			4156129	37,40€	4157107	19,40€
250	RM250	91-91	455059 455088	18,30€ 34,90€	4155124	18,00€			4156139	37,40€	4157101	19,60€
250	RM250	92-93	455059 455088	18,30€ 34,90€	4155124	18,00€			4156139	37,40€	4157101	19,60€
250	RM250	94-95	455059 455088	18,30€ 34,90€	4155124	18,00€			4156139	37,40€	4157101	19,60€
250	RM250	96-97	455073	24,50€	4155129	18,40€			4156144	37,40€	4157104	19,90€
250	RM250	98-98	455073	24,50€	4155129	18,40€			4156144	37,40€	4157104	19,90€
250	RM250	99-99	455073	24,50€	4155129	18,40€			4156144	37,40€	4157104	19,90€
250	RM250	00-00	455073	24,50€	4155129	18,40€			4156144	37,40€	4157104	19,90€
250	RM250	01-02	455086	31,50€	4155126	18,40€	2920011	18,50€	4156141	37,40€	4157103	19,40€
250	RM250	03-03	455086	31,50€	4155126	18,40€	2920011	18,50€	4156141	37,40€	4157103	19,40€
250	RM250	04-04	455086	31,50€	4155126	18,40€			4156141	37,40€	4157103	19,40€
250	RM250	05-08	455076	18,00€	4155127	18,40€			4156142	37,80€	4157100	19,40€
250	RMX250	89-89	455052	12,20€	4155117	18,10€			4156129	37,40€	4157107	19,40€
250	RMX250	90-90	455052	12,20€	4155117	18,10€			4156129	37,40€	4157107	19,40€
250	RMX250	91-91	455059 455088	18,30€ 34,90€	4155124	18,00€			4156139	37,40€	4157101	19,60€
250	RMX250	92-01	455059 455088	18,30€ 34,90€	4155124	18,00€			4156139	37,40€	4157101	19,60€
400	DR-Z 400 /S	00-09	455073	24,50€	4155129	18,40€			4156144	37,40€	4157104	19,90€
400	DR-Z 400 E	00-07	455073	24,50€	4155129	18,40€			4156144	37,40€	4157104	19,90€
400	RM400	78-78			4155110	18,20€						
400	RM400	79-80			4155112	18,10€			4156124	38,20€	4157119	19,40€
450	RM-Z 450	05-12	455076	18,00€	4155127	18,40€			4156142	37,80€	4157100	19,40€
450	RM-Z 450	13-14	455200	20,30€	4155132	18,10€			4156142	37,80€	4157105	19,60€
450	RM-Z 450	15-17	455073	24,50€	4155129	18,40€			4156144	37,40€	4157104	19,90€
450	RM-Z 450	18-22	455073	24,50€	4155129	18,40€			4156144	37,40€	4157104	19,90€
450	RMX450 Z	10-15	455086	31,50€	4155127	18,40€			4156142	37,80€	4157100	19,40€
500	RM500	83-87	455058	12,60€	4155122	18,10€			4156136	38,20€	4157117	19,40€
TM												
125	Cross MX125	98-04			4155135	18,00€			4156149	37,80€	4157138	19,40€
125	Cross MX125	09-11			4155130	18,00€			4156145	38,20€	4157140	19,40€
125	Enduro 125	98-04			4155135	18,00€			4156149	37,80€	4157138	19,40€
125	Enduro EN125	09-11			4155130	18,00€			4156145	38,20€	4157140	19,40€
125	SMR125	09-10			4155130	18,00€			4156145	38,20€	4157140	19,40€
250	Cross 250 /F	01-04			4155135	18,00€			4156149	37,80€	4157138	19,40€
250	Cross 250 /F	09-11			4155130	18,00€			4156145	38,20€	4157140	19,40€
250	Enduro 250 /F	01-04			4155135	18,00€			4156149	37,80€	4157138	19,40€
250	Enduro 250 /F	09-11			4155130	18,00€			4156145	38,20€	4157140	19,40€
300	Cross 300	01-04			4155135	18,00€			4156149	37,80€	4157138	19,40€
300	Cross 300	09-11			4155130	18,00€			4156145	38,20€	4157140	19,40€







Cyl.	Modèle	Années	CACHE POUSSIÈRE		KIT BAGUES DE FOURCHE		KIT RÉVISION DE FOURCHE		KIT RÉVISION AMORTISSEUR	
			KYB Technical Touch	€T.T.C.	ALL BALLS Rings	€T.T.C.	KYB Technical Touch	€T.T.C.	KYB Technical Touch	€T.T.C.
SUZUKI										
125	RM125	01-01			41386072	113,50€				
125	RM125	02-03			41386032	46,08€				
125	RM125	04-04			41386072	113,50€				
125	RM125	05-13			41386015	62,70€				
250	DR-Z 250	01-07			41386033	74,70€				
250	DR-Z 250	08-10								
250	RM-Z 250	04-04	2920028	25,75€	41386036	74,70€	2921231	104,00€	2921915	77,75€
250	RM-Z 250	05-06	2920028	25,75€	41386036	74,70€	2921231	104,00€	2921915	77,75€
250	RM-Z 250	07-12			41386015	62,70€				
250	RM-Z 250	13-15			41386108	48,70€				
250	RM-Z 250	16-18			41386138	-				
250	RM-Z 250	19-22			41386153	62,60€				
250	RM250	76-78								
250	RM250	79-82								
250	RM250	83-87			41386014	48,90€				
250	RM250	88-88			41386014	48,90€				
250	RM250	89-89			41386030	96,90€				
250	RM250	90-90			41386078	47,60€				
250	RM250	91-91			41386006	86,40€				
250	RM250	92-93			41386030	96,90€				
250	RM250	94-95								
250	RM250	96-97								
250	RM250	98-98			41386042	89,00€				
250	RM250	99-99								
250	RM250	00-00			41386040	89,00€				
250	RM250	01-02	2920026	19,96€	41386044	89,00€	2921228	75,50€	2921915	77,75€
250	RM250	03-03	2920026	19,96€	41386045	89,00€	2921229	75,50€	2921915	77,75€
250	RM250	04-04			41386046	89,90€				
250	RM250	05-08			41386020	41,00€				
250	RMX250	89-89								
250	RMX250	90-90			41386078	47,60€				
250	RMX250	91-91			41386006	86,40€				
250	RMX250	92-01			41386030	96,90€				
400	DR-Z 400 /S	00-09			41386037	89,90€				
400	DR-Z 400 E	00-07			41386037	89,90€				
400	RM400	78-78								
400	RM400	79-80								
450	RM-Z 450	05-12			41386015	62,70€				
450	RM-Z 450	13-14			41386108	48,70€				
450	RM-Z 450	15-17			41386130	40,90€				
450	RM-Z 450	18-22			41386134	40,80€				
450	RMX450 Z	10-15			41386015	62,70€				
500	RM500	83-87								
TM										
125	Cross MX125	98-04								
125	Cross MX125	09-11								
125	Enduro 125	98-04								
125	Enduro EN125	09-11								
125	SMR125	09-10								
250	Cross 250 /F	01-04								
250	Cross 250 /F	09-11								
250	Enduro 250 /F	01-04								
250	Enduro 250 /F	09-11								
300	Cross 300	01-04								
300	Cross 300	09-11								

Cyl.	Modèle	Années	SPI DE FOURCHE		KIT JOINTS SPI DE FOURCHE		JOINTS SPI		KIT JOINTS SPI ET CACHE POUSSIÈRE		KIT JOINTS CACHE POUSSIÈRE	
			 ATHENA	€T.T.C.	 ALL DANGLES	€T.T.C.	 KYB	€T.T.C.	 ALL DANGLES	€T.T.C.	 ALL DANGLES	€T.T.C.
TM												
300	Enduro 300	01-04			4155135	18,00€			4156149	37,80€	4157138	19,40€
300	Enduro 300	09-11			4155130	18,00€			4156145	38,20€	4157140	19,40€
400	Cross 400	02-04			4155135	18,00€			4156149	37,80€	4157138	19,40€
450	Cross 450 F	04-04			4155135	18,00€			4156149	37,80€	4157138	19,40€
450	Cross 450 F	09-11			4155130	18,00€			4156145	38,20€	4157140	19,40€
450	Enduro 450 F	04-04			4155135	18,00€			4156149	37,80€	4157138	19,40€
450	Enduro 450 F	09-11			4155130	18,00€			4156145	38,20€	4157140	19,40€
530	Cross 530 F	01-04			4155135	18,00€			4156149	37,80€	4157138	19,40€
530	Cross 530 F	09-11			4155130	18,00€			4156145	38,20€	4157140	19,40€
530	Enduro 530 F	02-04			4155135	18,00€			4156149	37,80€	4157138	19,40€
530	Enduro 530 F	09-11			4155130	18,00€			4156145	38,20€	4157140	19,40€
530	SMR530 F	09-11			4155130	18,00€			4156145	38,20€	4157140	19,40€
600	SMX600 F	10-11	455012	13,90€								
VOR												
400	EN400	02-02	455116 455124	45,30€ 36,60€	4155123	18,00€			4156137	37,40€	4157102	19,60€
400	MX400	02-02	455116 455124	45,30€ 36,60€	4155123	18,00€			4156137	37,40€	4157102	19,60€
400	SM400	02-02	455116 455124	45,30€ 36,60€	4155123	18,00€			4156137	37,40€	4157102	19,60€
450	EN450	02-02	455116 455124	45,30€ 36,60€								
450	MX450	02-02	455116 455124	45,30€ 36,60€								
450	SM450	02-02	455116 455124	45,30€ 36,60€								
530	EN530	02-02	455116 455124	45,30€ 36,60€								
530	MX530	02-02	455116 455124	45,30€ 36,60€								
530	SM530	02-02	455116 455124	45,30€ 36,60€								
YAMAHA												
50	PW50	18-21			4155100	18,10€						
50	TT-R50 E	18-22			4155100	18,10€						
60	YZ60	85-85	455004	10,60€	4155100	18,10€			4156100	37,40€	4157133	37,10€
65	YZ 65	18-22	455035	11,90€	4155110	18,20€	2920003	24,16€	4156121	38,20€	4157110	19,60€
80	PW80	83-13	455004	10,60€	4155100	18,10€			4156100	37,40€	4157133	37,10€
80	YZ80	74-78	455080	12,60€	4155101	34,60€						
80	YZ80	79-82	455013	14,20€	4155103	18,40€			4156106	38,20€	4157124	37,10€
80	YZ80	83-92	455024	11,10€	4155106	34,60€			4156112	67,70€	4157125	36,40€
80	YZ80	93-01	455035	11,90€	4155110	18,20€	2920003	24,16€	4156121	38,20€	4157110	19,60€
85	YZ85 /LW	02-18	455035	11,90€	4155110	18,20€	2920003	24,16€	4156121	38,20€	4157110	19,60€
85	YZ85 /LW	19-22	455035	11,90€	4155110	18,20€			4156121	38,20€	4157110	19,60€
90	TT90 R	00-03	455004	10,60€	4155100	18,10€			4156100	37,40€	4157133	37,10€
100	RT100	90-90			4155101	34,60€						
110	TT-R110 E	08-22	455035	11,90€	4155104	18,20€			4156170	37,40€	4157156	37,10€
125	TT125 R	00-08			4155102	33,90€			4156104	73,00€	4157114	19,40€
125	TT125 R	09-22			4155104	18,20€						
125	WR125	91-97	455057	12,60€								
125	WR125	98-03	455086	31,50€								
125	YZ125	76-76	455028	11,90€	4155133	34,60€						
125	YZ125	77-80	455036	11,90€	4155109	18,20€			4156120	73,00€	4157120	37,10€
125	YZ125	81-83	455043	11,00€	4155112	18,10€			4156124	38,20€	4157119	19,40€
125	YZ125	84-84	455056 455093	12,60€ 32,60€	4155120	18,10€			4156133	37,40€	4157108	19,40€
125	YZ125	85-85	455056 455093	12,60€ 32,60€	4155120	18,10€			41561331	37,40€	41571081	19,40€
125	YZ125	86-88	455052	12,20€	4155122	18,10€			4156136	38,20€	4157117	19,40€
125	YZ125	89-90	455052	12,20€	4155117	18,10€			4156129	37,40€	4157107	19,40€
125	YZ125	91-92	455058	12,60€	4155122	18,10€			4156135	37,40€	4157102	19,60€
125	YZ125	93-95	455058	12,60€	4155122	18,10€			4156135	37,40€	4157102	19,60€
125	YZ125	96-00	455086	31,50€	4155126	18,40€	2920011	18,50€	4156141	37,40€	4157103	19,40€
125	YZ125	01-03	455086	31,50€	4155126	18,40€	2920011	18,50€	4156141	37,40€	4157103	19,40€



Cyl.	Modèle	Années	CACHE POUSSIÈRE		KIT BAGUES DE FOURCHE		KIT RÉVISION DE FOURCHE		KIT RÉVISION AMORTISSEUR	
			KYB Technical Touch	€T.T.C.	ALL BALLS Rings	€T.T.C.	KYB Technical Touch	€T.T.C.	KYB Technical Touch	€T.T.C.
TM										
300	Enduro 300	01-04								
300	Enduro 300	09-11								
400	Cross 400	02-04								
450	Cross 450 F	04-04								
450	Cross 450 F	09-11								
450	Enduro 450 F	04-04								
450	Enduro 450 F	09-11								
530	Cross 530 F	01-04								
530	Cross 530 F	09-11								
530	Enduro 530 F	02-04								
530	Enduro 530 F	09-11								
530	SMR530 F	09-11								
600	SMX600 F	10-11								
VOR										
400	EN400	02-02								
400	MX400	02-02								
400	SM400	02-02								
450	EN450	02-02								
450	MX450	02-02								
450	SM450	02-02								
530	EN530	02-02								
530	MX530	02-02								
530	SM530	02-02								
YAMAHA										
50	PW50	18-21								
50	TT-R50 E	18-22								
60	YZ60	85-85								
65	YZ 65	18-22			41386047	85,30€				
80	PW80	83-13								
80	YZ80	74-78								
80	YZ80	79-82								
80	YZ80	83-92								
80	YZ80	93-01	2920019	25,25€	41386047	85,30€	2921225	78,76€		
85	YZ85 /LW	02-18	2920019	25,25€	41386047	85,30€	2921225	78,76€	2921905	109,25€
85	YZ85 /LW	19-22			41386047	85,30€				
90	TT90 R	00-03								
100	RT100	90-90								
110	TT-R110 E	08-22								
125	TT125 R	00-08								
125	TT125 R	09-22								
125	WR125	91-97								
125	WR125	98-03								
125	YZ125	76-76								
125	YZ125	77-80								
125	YZ125	81-83								
125	YZ125	84-84								
125	YZ125	85-85								
125	YZ125	86-88			41386048	95,90€				
125	YZ125	89-90			41386078	47,60€				
125	YZ125	91-92			41386048	95,90€				
125	YZ125	93-95			41386014	48,90€				
125	YZ125	96-00	2920026	19,96€	41386010	47,70€	2921228	75,50€		
125	YZ125	01-03	2920026	19,96€	41386010	47,70€	2921228	75,50€	2921911	77,75€

Cyl.	Modèle	Années	SPI DE FOURCHE		KIT JOINTS SPI DE FOURCHE		JOINTS SPI		KIT JOINTS SPI ET CACHE POUSSIÈRE		KIT JOINTS CACHE POUSSIÈRE	
			 ATHENA	€T.T.C.	 ALL DAGES Rally	€T.T.C.	 KYB Technical Touch	€T.T.C.	 ALL DAGES Rally	€T.T.C.	 ALL DAGES Rally	€T.T.C.
YAMAHA												
125	YZ125	04-04	455123	32,00€	4155132	18,10€	2920012	23,75€	4156147	37,40€	4157105	19,60€
125	YZ125	05-05	455139	33,90€	4155132	18,10€	2920014	23,75€	4156147	37,40€	4157105	19,60€
125	YZ125	06-14	455139	33,90€	4155132	18,10€	2920014	23,75€	4156147	37,40€	4157105	19,60€
125	YZ125	15-17	455128	59,10€	4155132	18,10€	2920013	27,25€	4156147	37,40€	4157105	19,60€
125	YZ125	18-21	455128	59,10€	4155132	18,10€	2920013	27,25€	4156147	37,40€	4157105	19,60€
125	YZ125	22-22	455128	59,10€	4155132	18,10€	2920013	27,25€	4156147	37,40€	4157105	19,60€
200	WR200 R	91-97	455052	12,20€	4155117	18,10€			4156129	37,40€	4157107	19,40€
225	TT225R	01-01	455037	13,00€	4155109	18,20€			4156119	38,20€	4157110	19,60€
230	TT230R	05-16	455037	13,00€	4155109	18,20€			4156119	38,20€	4157110	19,60€
250	TT250 R	87-92	455036	11,90€								
250	TT250 R	93-98	455057	12,60€	4155122	18,10€			4156136	38,20€	4157117	19,40€
250	TT250 R	99-06	455057	12,60€	4155122	18,10€			4156136	38,20€	4157117	19,40€
250	TT250 R	07-07	455057	12,60€								
250	WR250	91-91	455057 455089	12,60€ 34,40€	4155122	18,10€			4156135	37,40€	4157102	19,60€
250	WR250	92-93	455057 455089	12,60€ 34,40€	4155122	18,10€			4156135	37,40€	4157102	19,60€
250	WR250	94-97	455057 455089	12,60€ 34,40€	4155122	18,10€			4156135	37,40€	4157102	19,60€
250	WR250	98-02	455086	31,50€	4155126	18,40€			4156141	37,40€	4157103	19,40€
250	WR250 F	01-02	455086	31,50€	4155126	18,40€	2920011	18,50€	4156141	37,40€	4157103	19,40€
250	WR250 F	03-03	455086	31,50€	4155126	18,40€	2920011	18,50€	4156141	37,40€	4157103	19,40€
250	WR250 F	04-04	455086	31,50€	4155126	18,40€	2920011	18,50€	4156141	37,40€	4157103	19,40€
250	WR250 F	05-05	455086	31,50€	4155132	18,10€	2920012	23,75€	4156147	37,40€	4157105	19,60€
250	WR250 F	06-06	455086	31,50€	4155132	18,10€	2920012	23,75€	4156147	37,40€	4157105	19,60€
250	WR250 F	07-11	455139	33,90€	4155132	18,10€	2920014	23,75€	4156147	37,40€	4157105	19,60€
250	WR250 F	12-14	455139	33,90€	4155132	18,10€	2920013	27,25€	4156147	37,40€	4157105	19,60€
250	WR250 F	15-17	455128	59,10€	4155132	18,10€	2920013	27,25€	4156147	37,40€	4157105	19,60€
250	WR250 F	18-22	455128	59,10€	4155132	18,10€	2920013	27,25€	4156147	37,40€	4157105	19,60€
250	WR250 Z	91-91	455057	12,60€	4155122	18,10€			4156135	37,40€	4157102	19,60€
250	WR250 Z	92-97	455057	12,60€	4155122	18,10€			4156135	37,40€	4157102	19,60€
250	WR250 Z	98-05	455086	31,50€	4155126	18,40€			4156141	37,40€	4157103	19,40€
250	YZ250	80-80	455043	11,00€	4155112	18,10€			4156124	38,20€	4157119	19,40€
250	YZ250	81-81	455058	12,60€	4155122	18,10€			4156136	38,20€	4157117	19,40€
250	YZ250	82-88	455058	12,60€	4155122	18,10€			4156136	38,20€	4157117	19,40€
250	YZ250	89-90	455052	12,20€	4155117	18,10€			4156129	37,40€	4157107	19,40€
250	YZ250	91-92	455058	12,60€	4155122	18,10€			4156135	37,40€	4157102	19,60€
250	YZ250	93-95	455058	12,60€	4155122	18,10€			4156135	37,40€	4157102	19,60€
250	YZ250	96-00	455086	31,50€	4155126	18,40€	2920011	18,50€	4156141	37,40€	4157103	19,40€
250	YZ250	01-03	455086	31,50€	4155126	18,40€	2920011	18,50€	4156141	37,40€	4157103	19,40€
250	YZ250	04-04	455123	32,00€	4155132	18,10€	2920012	23,75€	4156147	37,40€	4157105	19,60€
250	YZ250	05-05	455139	33,90€	4155132	18,10€	2920014	23,75€	4156147	37,40€	4157105	19,60€
250	YZ250	06-14	455139	33,90€	4155132	18,10€	2920014	23,75€	4156147	37,40€	4157105	19,60€
250	YZ250	15-16	455128	59,10€	4155132	18,10€	2920013	27,25€	4156147	37,40€	4157105	19,60€
250	YZ250	17-17	455128	59,10€	4155132	18,10€	2920013	27,25€	4156147	37,40€	4157105	19,60€
250	YZ250	18-21	455128	59,10€	4155132	18,10€	2920013	27,25€	4156147	37,40€	4157105	19,60€
250	YZ250	22-22	455128	59,10€	4155132	18,10€	2920013	27,25€	4156147	37,40€	4157105	19,60€
250	YZ250 F	01-03	455086	31,50€	4155126	18,40€	2920011	18,50€	4156141	37,40€	4157103	19,40€
250	YZ250 F	04-04	455123	32,00€	4155132	18,10€	2920012	23,75€	4156147	37,40€	4157105	19,60€
250	YZ250 F	05-05	455139	33,90€	4155132	18,10€	2920014	23,75€	4156147	37,40€	4157105	19,60€
250	YZ250 F	06-11	455139	33,90€	4155132	18,10€	2920014	23,75€	4156147	37,40€	4157105	19,60€
250	YZ250 F	12-13	455139	33,90€	4155132	18,10€	2920014	23,75€	4156147	37,40€	4157105	19,60€
250	YZ250 F	14-14	455139	33,90€	4155132	18,10€	2920014	23,75€	4156147	37,40€	4157105	19,60€
250	YZ250 F	15-17	455128	59,10€	4155132	18,10€	2920013	27,25€	4156147	37,40€	4157105	19,60€
250	YZ250 F	18-18	455128	59,10€	4155132	18,10€	2920013	27,25€	4156147	37,40€	4157105	19,60€
250	YZ250 F	19-21	455128	59,10€	4155132	18,10€	2920013	27,25€	4156147	37,40€	4157105	19,60€
250	YZ250 F	22-22	455128	59,10€	4155132	18,10€	2920013	27,25€	4156147	37,40€	4157105	19,60€
250	YZ250 X	16-16	455128	59,10€	4155132	18,10€	2920013	27,25€	4156147	37,40€	4157105	19,60€
250	YZ250 X	17-17	455128	59,10€	4155132	18,10€	2920013	27,25€	4156147	37,40€	4157105	19,60€
250	YZ250 X	18-19	455128	59,10€	4155132	18,10€	2920013	27,25€	4156147	37,40€	4157105	19,60€



Cyl.	Modèle	Années	CACHE POUSSIÈRE		KIT BAGUES DE FOURCHE		KIT RÉVISION DE FOURCHE		KIT RÉVISION AMORTISSEUR	
			KYB <small>Technical Touch</small>	€T.T.C.	ALL BALLS <small>Rings</small>	€T.T.C.	KYB <small>Technical Touch</small>	€T.T.C.	KYB <small>Technical Touch</small>	€T.T.C.
YAMAHA										
125	YZ125	04-04	2920028	25,75€	41386050	90,70€	2921231	104,00€	2921911	77,75€
125	YZ125	05-05	2920028	25,75€	41386068	62,70€	2921231	104,00€	2921911	77,75€
125	YZ125	06-14	2920028	25,75€	41386068	62,70€	2921231	104,00€	2921918	77,75€
125	YZ125	15-17	2920028	25,75€	41386068	62,70€	2921231	104,00€	2921918	77,75€
125	YZ125	18-21	2920028	25,75€	41386126	52,90€	2921231	104,00€	2921918	77,75€
125	YZ125	22-22	2920028	25,75€			2921231	104,00€	2921918	77,75€
200	WR200 R	91-97			41386018	93,10€				
225	TT225R	01-01								
230	TT230R	05-16								
250	TT250 R	87-92								
250	TT250 R	93-98								
250	TT250 R	99-06			41386063	50,50€				
250	TT250 R	07-07			41386063	50,50€				
250	WR250	91-91								
250	WR250	92-93			41386048	95,90€				
250	WR250	94-97			41386014	48,90€				
250	WR250	98-02								
250	WR250 F	01-02	2920026	19,96€	41386010	47,70€	2921228	75,50€		
250	WR250 F	03-03	2920026	19,96€	41386010	47,70€	2921228	75,50€	2921911	77,75€
250	WR250 F	04-04	2920026	19,96€	41386045	89,00€	2921228	75,50€	2921911	77,75€
250	WR250 F	05-05	2920028	25,75€	41386036	74,70€	2921231	104,00€	2921911	77,75€
250	WR250 F	06-06	2920028	25,75€	41386050	90,70€	2921231	104,00€	2921911	77,75€
250	WR250 F	07-11	2920028	25,75€	41386050	90,70€	2921231	104,00€	2921913	77,75€
250	WR250 F	12-14			41386050	90,70€				
250	WR250 F	15-17			41386068	62,70€				
250	WR250 F	18-22			41386126	52,90€				
250	WR250 Z	91-91								
250	WR250 Z	92-97			41386014	48,90€				
250	WR250 Z	98-05								
250	YZ250	80-80								
250	YZ250	81-81								
250	YZ250	82-88			41386048	95,90€				
250	YZ250	89-90								
250	YZ250	91-92			41386048	95,90€				
250	YZ250	93-95			41386014	48,90€				
250	YZ250	96-00	2920026	19,96€	41386010	47,70€	2921228	75,50€		
250	YZ250	01-03	2920026	19,96€	41386010	47,70€	2921228	75,50€	2921911	77,75€
250	YZ250	04-04	2920028	25,75€	41386050	90,70€	2921231	104,00€	2921911	77,75€
250	YZ250	05-05	2920028	25,75€	41386068	62,70€	2921231	104,00€	2921911	77,75€
250	YZ250	06-14	2920028	25,75€	41386068	62,70€	2921231	104,00€	2921918	77,75€
250	YZ250	15-16	2920028	25,75€	41386068	62,70€	2921231	104,00€	2921918	77,75€
250	YZ250	17-17	2920028	25,75€	41386126	52,90€	2921231	104,00€	2921918	77,75€
250	YZ250	18-21			41386126	52,90€				
250	YZ250	22-22								
250	YZ250 F	01-03	2920026	19,96€	41386010	47,70€	2921228	75,50€	2921911	77,75€
250	YZ250 F	04-04	2920028	25,75€	41386050	90,70€	2921231	104,00€	2921911	77,75€
250	YZ250 F	05-05	2920028	25,75€	41386068	62,70€	2921231	104,00€	2921911	77,75€
250	YZ250 F	06-11	2920028	25,75€	41386068	62,70€	2921231	104,00€	2921918	77,75€
250	YZ250 F	12-13	2920028	25,75€	41386068	62,70€	2921231	104,00€	2921919	77,75€
250	YZ250 F	14-14	2920028	25,75€	41386068	62,70€	2921231	104,00€	2921923	77,75€
250	YZ250 F	15-17	2920028	25,75€	41386068	62,70€	2921231	104,00€	2921923	77,75€
250	YZ250 F	18-18	2920028	25,75€	41386126	52,90€	2921231	104,00€	2921923	77,75€
250	YZ250 F	19-21			41386126	52,90€				
250	YZ250 F	22-22								
250	YZ250 X	16-16	2920028	25,75€	41386068	62,70€	2921231	104,00€	2921918	77,75€
250	YZ250 X	17-17	2920028	25,75€	41386126	52,90€	2921231	104,00€	2921918	77,75€
250	YZ250 X	18-19			41386126	52,90€				

Cyl.	Modèle	Années	SPI DE FOURCHE		KIT JOINTS SPI DE FOURCHE		JOINTS SPI		KIT JOINTS SPI ET CACHE POUSSIÈRE		KIT JOINTS CACHE POUSSIÈRE	
			 ATHENA	€T.T.C.	 ALL BIKES Race	€T.T.C.	 KYB Technical Touch	€T.T.C.	 ALL BIKES Race	€T.T.C.	 ALL BIKES Race	€T.T.C.
YAMAHA												
350	TT350	86-97	455054	14,50€	4155119	18,10€			4156132	37,40€	4157115	19,40€
400	WR400 F	98-00	455086	31,50€	4155126	18,40€	2920011	18,50€	4156141	37,40€	4157103	19,40€
400	WR400 F	01-01	455086	31,50€	4155126	18,40€			4156141	37,40€	4157103	19,40€
400	YZ400 F	98-99	455086	31,50€	4155126	18,40€	2920011	18,50€	4156141	37,40€	4157103	19,40€
426	WR426 F	01-02	455086	31,50€	4155126	18,40€	2920011	18,50€	4156141	37,40€	4157103	19,40€
426	YZ426 F	00-00	455086	31,50€	4155126	18,40€	2920011	18,50€	4156141	37,40€	4157103	19,40€
426	YZ426 F	01-02	455086	31,50€	4155126	18,40€	2920011	18,50€	4156141	37,40€	4157103	19,40€
450	WR450 F	03-03	455086	31,50€	4155126	18,40€	2920011	18,50€	4156141	37,40€	4157103	19,40€
450	WR450 F	04-04	455123	32,00€	4155126	18,40€	2920011	18,50€	4156141	37,40€	4157103	19,40€
450	WR450 F	05-06	455123	32,00€	4155132	18,10€	2920012	23,75€	4156147	37,40€	4157105	19,60€
450	WR450 F	07-11	455139	33,90€	4155132	18,10€	2920014	23,75€	4156147	37,40€	4157105	19,60€
450	WR450 F	12-14	455128	59,10€	4155132	18,10€	2920014	23,75€	4156147	37,40€	4157105	19,60€
450	WR450 F	15-15	455128	59,10€	4155132	18,10€	2920013	27,25€	4156147	37,40€	4157105	19,60€
450	WR450 F	16-22	455128	59,10€	4155132	18,10€	2920013	27,25€	4156147	37,40€	4157105	19,60€
450	YZ450 F	03-03	455086	31,50€	4155126	18,40€	2920011	18,50€	4156141	37,40€	4157103	19,40€
450	YZ450 F	04-04	455123	32,00€	4155132	18,10€	2920012	23,75€	4156147	37,40€	4157105	19,60€
450	YZ450 F	05-05	455139	33,90€	4155132	18,10€	2920014	23,75€	4156147	37,40€	4157105	19,60€
450	YZ450 F	06-09	455139	33,90€	4155132	18,10€	2920014	23,75€	4156147	37,40€	4157105	19,60€
450	YZ450 F	10-14	455128	59,10€	4155132	18,10€	2920014	23,75€	4156147	37,40€	4157105	19,60€
450	YZ450 F	15-18	455128	59,10€	4155132	18,10€	2920013	27,25€	4156147	37,40€	4157105	19,60€
450	YZ450 F	19-21	455128	59,10€	4155132	18,10€	2920013	27,25€	4156147	37,40€	4157105	19,60€
450	YZ450 F	22-22	455128	59,10€	4155132	18,10€	2920013	27,25€	4156147	37,40€	4157105	19,60€

















Cyl.	Modèle	Années	CACHE POUSSIÈRE		KIT BAGUES DE FOURCHE		KIT RÉVISION DE FOURCHE		KIT RÉVISION AMORTISSEUR	
			KYB Technical Touch	€T.T.C.	ALL BALLS Rings	€T.T.C.	KYB Technical Touch	€T.T.C.	KYB Technical Touch	€T.T.C.
YAMAHA										
350	TT350	86-97								
400	WR400 F	98-00	2920026	19,96€	41386010	47,70€	2921228	75,50€		
400	WR400 F	01-01			41386010	47,70€				
400	YZ400 F	98-99	2920026	19,96€	41386010	47,70€	2921228	75,50€		
426	WR426 F	01-02	2920026	19,96€	41386010	47,70€	2921228	75,50€		
426	YZ426 F	00-00	2920026	19,96€	41386010	47,70€	2921228	75,50€		
426	YZ426 F	01-02	2920026	19,96€	41386010	47,70€	2921228	75,50€	2921911	77,75€
450	WR450 F	03-03	2920026	19,96€	41386010	47,70€	2921228	75,50€	2921911	77,75€
450	WR450 F	04-04	2920026	19,96€	41386045	89,00€	2921228	75,50€	2921911	77,75€
450	WR450 F	05-06	2920028	25,75€	41386050	90,70€	2921231	104,00€	2921911	77,75€
450	WR450 F	07-11	2920028	25,75€	41386050	90,70€	2921231	104,00€	2921913	77,75€
450	WR450 F	12-14	2920028	25,75€	41386075	33,10€	2921231	104,00€		
450	WR450 F	15-15	2920028	25,75€	41386075	33,10€	2921231	104,00€		
450	WR450 F	16-22			41386126	52,90€				
450	YZ450 F	03-03	2920026	19,96€	41386010	47,70€	2921228	75,50€	2921911	77,75€
450	YZ450 F	04-04	2920028	25,75€	41386050	90,70€	2921231	104,00€	2921911	77,75€
450	YZ450 F	05-05	2920028	25,75€	41386068	62,70€	2921231	104,00€	2921911	77,75€
450	YZ450 F	06-09	2920028	25,75€	41386068	62,70€	2921231	104,00€	2921918	77,75€
450	YZ450 F	10-14	2920028	25,75€	41386075	33,10€	2921231	104,00€	2921923	77,75€
450	YZ450 F	15-18	2920028	25,75€	41386075	33,10€	2921231	104,00€	2921923	77,75€
450	YZ450 F	19-21			41386075	33,10€				
450	YZ450 F	22-22								









2017 © Federación VEROT







Cyl.	Modèle	Années	ROUE AVANT				ROUE ARRIERE									
			ROULEMENTS ET JOINTS		ROULEMENTS		ENTRETOISES		ROULEMENTS ET JOINTS		ROULEMENTS		ENTRETOISES			
				€T.T.C.		€T.T.C.		€T.T.C.		€T.T.C.		€T.T.C.		€T.T.C.		
APRILIA																
180	Quasar (quad)	04-04			FWKT022	28,90€							RWKB001	24,90€		
180	Quasar Grip (quad)	04-04			FWKT022	28,90€							RWKB001	24,90€		
240	Climber (trial)	89-89			FWKT022	28,90€							RWKB001	24,90€		
350	Tuareg	86-86	41251070	20,40€	FWKT022	28,90€							RWKB001	24,90€		
350	Tuareg	89-89			FWKT022	28,90€							RWKB001	24,90€		
450	RXV450	06-14	41251570	51,70€					41251406	29,30€			RWKY148	28,90€		
450	SXV450	06-14	41251570	51,70€					41251406	29,30€			RWKY148	28,90€		
550	RXV550	06-14	41251570	51,70€					41251406	29,30€			RWKY148	28,90€		
550	SXV550	06-14	41251570	51,70€					41251406	29,30€			RWKY148	28,90€		
BETA																
125	Evo 125 (Trial)	12-13	41251690	46,80€					41251070	20,40€						
125	Evo 125 (Trial)	14-16	41251210	12,40€					41251070	20,40€						
125	Evo 125 (Trial)	17-22	41251690	46,80€					41251070	20,40€						
125	RR125 Enduro	18-22	41251402	29,30€	FWKT022	28,90€			41251404	24,70€			RWKB001	24,90€		
200	EVO (Tial)	12-20	41251690	46,80€					41251070	20,40€						
200	RR200 Enduro	19-22	41251402	29,30€	FWKT022	28,90€			41251404	24,70€			RWKB001	24,90€		
250	EVO (Trial)	12-22	41251690	46,80€					41251070	20,40€						
250	EVO (Trial) 4T	12-19	41251690	46,80€					41251070	20,40€						
250	RR250 Enduro	13-15	41251402	29,30€	FWKT022	28,90€			41251404	24,70€			RWKB001	24,90€		
250	RR250 Enduro 2T	13-22	41251402	29,30€	FWKT022	28,90€			41251404	24,70€			RWKB001	24,90€		
250	XTrainer	18-22	41251402	29,30€	FWKT022	28,90€			41251404	24,70€			RWKB001	24,90€		
300	300RR Enduro	13-17	41251402	29,30€	FWKT022	28,90€			41251404	24,70€			RWKB001	24,90€		
300	300RR Enduro 2T	13-18	41251402	29,30€	FWKT022	28,90€			41251404	24,70€			RWKB001	24,90€		
300	EVO (Trial)	09-10	41251690	46,80€					41251690	46,80€						
300	EVO (Trial)	11-22	41251690	46,80€					41251070	20,40€						
300	EVO (Trial) 4T	12-22	41251690	46,80€					41251070	20,40€						
300	XTrainer	18-22	41251402	29,30€	FWKT022	28,90€			41251404	24,70€			RWKB001	24,90€		
350	350RR Enduro	12-22	41251402	29,30€	FWKT022	28,90€			41251404	24,70€			RWKB001	24,90€		
390	RR390 Enduro	15-22	41251402	29,30€	FWKT022	28,90€			41251404	24,70€			RWKB001	24,90€		
400	RR400 Enduro	05-10	41251402	29,30€	FWKT022	28,90€										
400	RR400 Enduro	11-15	41251402	29,30€	FWKT022	28,90€			41251404	24,70€			RWKB001	24,90€		
430	RR430 Enduro	13-22	41251402	29,30€	FWKT022	28,90€			41251404	24,70€			RWKB001	24,90€		
450	RR450 Enduro	05-10	41251402	29,30€	FWKT022	28,90€										
450	RR450 Enduro	11-15	41251402	29,30€	FWKT022	28,90€			41251404	24,70€			RWKB001	24,90€		
480	RR480 Enduro	13-22	41251402	29,30€	FWKT022	28,90€			41251404	24,70€			RWKB001	24,90€		
498	RR498 Enduro	12-15	41251402	29,30€	FWKT022	28,90€			41251404	24,70€			RWKB001	24,90€		
520	RR520 Enduro	13-15	41251402	29,30€	FWKT022	28,90€			41251404	24,70€			RWKB001	24,90€		
525	RR525 Enduro	05-09	41251402	29,30€	FWKT022	28,90€										
BMW																
450	G450 X	08-11	41251406	29,30€					41251406	29,30€			RWKY148	28,90€		
FANTIC																
125	XE 125	21-22	41251092	27,50€	FWKY032	28,90€	41111100	24,60€	41251252	30,70€			RWKY146	28,90€	411110811	40,70€
125	XX 125	21-22	41251092	27,50€	FWKY032	28,90€	41111100	24,60€	41251252	30,70€			RWKY146	28,90€	411110811	40,70€
250	XEF 250	21-22	41251482	33,60€	FWKY032	28,90€	41111073	11,00€	41251252	30,70€			RWKY171	28,90€	411110811	40,70€
250	XX 250	22-22	41251092	27,50€	FWKY032	28,90€	41111100	24,60€	41251252	30,70€			RWKY146	28,90€	411110811	40,70€
250	XXF 250	22-22	41251482	33,60€	FWKS047	28,90€	41111107	25,90€	41251406	29,30€			RWKY148	28,90€	411110991	76,40€
450	XEF 450	22-22	41251482	33,60€	FWKY032	28,90€	41111074	30,40€	41251252	30,70€			RWKY171	28,90€	411110811	40,70€
450	XXF 450	22-22	41251482	33,60€	FWKS047	28,90€	41111107	25,90€	41251406	29,30€			RWKY148	28,90€		
GAS GAS																
50	MC50	21-22	41251135	10,30€	FWKT025	19,90€			41251711	14,20€						
65	MC65	06-07	41251425	29,80€					41251425	29,80€						
65	MC65	21-22	41251135	10,30€	FWKT025	19,90€			41251345	14,10€			RWKT040	38,90€		
85	MC85	21-22	41251406	29,30€			41111051	40,30€	41251273	24,80€			RWKT039	24,90€	411110841	28,80€
125	EC125	01-02	41251070	20,40€	FWKG001	28,90€			41251457	27,20€						
125	EC125	03-03	41251070	20,40€	FWKG001	28,90€			41251458	26,90€			RWKG007	38,90€		
125	EC125	04-12	41251364	29,60€	FWKG002	28,90€			41251458	26,90€			RWKG007	38,90€		
125	EC125	13-14	41251364	29,60€	FWKG002	28,90€										
125	MC125	01-01	41251070	20,40€	FWKG001	28,90€			41251457	27,20€						









Cyl.	Modèle	Années	ROUE AVANT						ROUE ARRIERE					
			ROULEMENTS ET JOINTS		ROULEMENTS		ENTRETOISES		ROULEMENTS ET JOINTS		ROULEMENTS		ENTRETOISES	
				€T.T.C.		€T.T.C.		€T.T.C.		€T.T.C.		€T.T.C.		€T.T.C.
125	MC125	02-02	41251070	20,40€	FWKG002	28,90€			41251457	27,20€				
125	MC125	03-03	41251070	20,40€	FWKG002	28,90€			41251458	26,90€	RWKG007	38,90€		
125	MC125	04-09	41251364	29,60€	FWKG002	28,90€			41251458	26,90€	RWKG007	38,90€		
125	MC125	21-22	41251402	29,30€	FWKT022	28,90€	411111031	30,70€	41251273	24,80€	RWKT039	24,90€	411111021	58,80€
125	Pampera 125	02-04	41251135	10,30€					41251135	10,30€				
125	SM125	02-02	41251135	10,30€	FWKG001	28,90€			41251135	10,30€				
125	SM125	03-03	41251135	10,30€	FWKG001	28,90€			41251135	10,30€	RWKG007	38,90€		
125	SM125	04-05	41251135	10,30€	FWKG002	28,90€			41251135	10,30€	RWKG007	38,90€		
125	SM125	06-08	41251070	20,40€	FWKG002	28,90€			41251458	26,90€	RWKG007	38,90€		
125	SM125	09-09	41251070	20,40€	FWKG001	28,90€			41251458	26,90€	RWKG007	38,90€		
125	TXT125	00-03	41251417	29,80€					41251417	29,80€				
125	TXT125 Pro	04-06	41251417	29,80€					41251417	29,80€				
125	TXT125 Pro	07-17	41251484	38,50€					41251417	29,80€				
125	TXT125 Racing	18-22	41251417	29,80€					41251417	29,80€				
200	EC200	99-02	41251070	20,40€	FWKG001	28,90€			41251457	27,20€				
200	EC200	03-03	41251070	20,40€	FWKG001	28,90€			41251458	26,90€	RWKG007	38,90€		
200	EC200	04-13	41251364	29,60€	FWKG002	28,90€			41251458	26,90€	RWKG007	38,90€		
200	EC200	14-14	41251364	29,60€	FWKG002	28,90€								
200	EC200	15-20	41251364	29,60€	FWKG002	28,90€			41251458	26,90€	RWKG007	38,90€		
200	EC200 Hobby	99-02			FWKG001	28,90€								
200	EC200 Hobby	03-03			FWKG001	28,90€					RWKG007	38,90€		
200	EC200 Hobby	04-11	41251364	29,60€	FWKG002	28,90€			41251458	26,90€	RWKG007	38,90€		
200	EC200 Ranger	19-20	41251364	29,60€	FWKG002	28,90€			41251458	26,90€	RWKG007	38,90€		
200	TXT200	00-06	41251417	29,80€					41251417	29,80€				
200	TXT200	07-13	41251484	38,50€					41251417	29,80€				
250	EC250	96-02	41251070	20,40€	FWKG001	28,90€			41251457	27,20€				
250	EC250	03-03	41251070	20,40€	FWKG001	28,90€			41251458	26,90€	RWKG007	38,90€		
250	EC250	04-13	41251364	29,60€	FWKG002	28,90€			41251458	26,90€	RWKG007	38,90€		
250	EC250	14-14	41251364	29,60€	FWKG002	28,90€								
250	EC250	15-20	41251364	29,60€	FWKG002	28,90€			41251458	26,90€	RWKG007	38,90€		
250	EC250	21-22	41251402	29,30€	FWKT022	28,90€	411111031	30,70€	41251273	24,80€	RWKT039	24,90€	411110841	28,80€
250	EC250F	21-22	41251402	29,30€	FWKT022	28,90€	411111031	30,70€	41251273	24,80€	RWKT039	24,90€	411110841	28,80€
250	MC250	99-02	41251070	20,40€	FWKG001	28,90€			41251457	27,20€				
250	MC250	03-03	41251070	20,40€	FWKG001	28,90€			41251458	26,90€	RWKG007	38,90€		
250	MC250	04-09	41251364	29,60€	FWKG002	28,90€			41251458	26,90€	RWKG007	38,90€		
250	MC250	22-22	41251402	29,30€	FWKT022	28,90€	411111031	30,70€	41251273	24,80€	RWKT039	24,90€	411111021	58,80€
250	MC250F	21-22	41251402	29,30€	FWKT022	28,90€	411111031	30,70€	41251273	24,80€	RWKT039	24,90€	411111021	58,80€
250	Pampera 250	02-04	41251135	10,30€					41251135	10,30€				
250	TXT250	02-03	41251417	29,80€					41251417	29,80€				
250	TXT250	04-18	41251484	38,50€					41251417	29,80€				
250	TXT250	19-22	41251417	29,80€					41251417	29,80€				
280	TXT280	00-18	41251484	38,50€					41251417	29,80€				
280	TXT280	19-22	41251417	29,80€					41251417	29,80€				
300	EC300	99-02	41251070	20,40€	FWKG001	28,90€			41251457	27,20€				
300	EC300	03-03	41251070	20,40€	FWKG001	28,90€			41251458	26,90€	RWKG007	38,90€		
300	EC300	04-20	41251364	29,60€	FWKG002	28,90€			41251458	26,90€	RWKG007	38,90€		
300	EC300	21-22	41251402	29,30€	FWKT022	28,90€	411111031	30,70€	41251273	24,80€	RWKT039	24,90€	411110841	28,80€
300	EC300 Ranger	19-20	41251364	29,60€	FWKG002	28,90€			41251458	26,90€	RWKG007	38,90€		
300	TXT300	04-06	41251484	38,50€					41251417	29,80€				
300	TXT300 Pro	07-18	41251484	38,50€					41251417	29,80€				
300	TXT300 Pro	19-22	41251417	29,80€					41251417	29,80€				
350	EC350F	21-22	41251402	29,30€	FWKT022	28,90€	411111031	30,70€	41251273	24,80€	RWKT039	24,90€	411110841	28,80€
350	MC350F	22-22	41251402	29,30€	FWKT022	28,90€	411111031	30,70€	41251273	24,80€	RWKT039	24,90€	411110841	28,80€
450	EC450 FSE	99-02			FWKG001	28,90€								
450	EC450 FSE	03-06	41251364	29,60€	FWKG002	28,90€			41251458	26,90€	RWKG007	38,90€		
450	EC450 FSR	07-09	41251364	29,60€	FWKG002	28,90€			41251458	26,90€	RWKG007	38,90€		
450	EC450 FSR	10-14	41251484	38,50€					41251417	29,80€				
450	MC450F	21-22	41251402	29,30€	FWKT022	28,90€	411111031	30,70€	41251273	24,80€	RWKT039	24,90€	411111021	58,80€







Cyl.	Modèle	Années	ROUE AVANT				ROUE ARRIERE							
			ROULEMENTS ET JOINTS		ROULEMENTS		ENTRETOISES		ROULEMENTS ET JOINTS		ROULEMENTS		ENTRETOISES	
				€T.T.C.		€T.T.C.		€T.T.C.		€T.T.C.		€T.T.C.		€T.T.C.
HONDA														
50	CRF50	04-20	41251170	22,40€					41251167	27,10€				
50	CRF50	21-22	41251170	22,40€					41251645	13,50€				
50	XR50	00-03	41251170	22,40€					41251167	27,10€				
70	CRF70	04-13	41251027	13,90€	FWKH034	19,90€			41251191	12,40€				
70	XR70 R	97-03	41251027	13,90€	FWKH034	19,90€			41251191	12,40€				
80	CR80 R	80-81	41251072	31,60€					41251072	31,60€				
80	CR80 R	82-82	41251072	31,60€					41251191	12,40€				
80	CR80 R	83-85	41251027	13,90€	FWKH034	19,90€			41251191	12,40€				
80	CR80 R	86-86	41251027	13,90€	FWKH034	19,90€			41251160	14,80€	RWKH200	19,90€		
80	CR80 R	87-95	41251027	13,90€	FWKH034	19,90€			41251160	14,80€	RWKH200	19,90€		
80	CR80 R	96-02	41251027	13,90€	FWKH034	19,90€			41251160	14,80€	RWKH200	19,90€		
80	CRF80	04-09	41251027	13,90€	FWKH034	19,90€			41251191	12,40€				
80	XR80	79-84	41251072	31,60€					41251300	27,60€				
85	CR85	03-08	41251027	13,90€	FWKH034	19,90€			41251160	14,80€	RWKH200	19,90€		
90	TRX90 Fourtrax	93-98	41251052	29,40€					41251029	86,30€				
100	CRF100	04-13	41251027	13,90€	FWKH034	19,90€			41251191	12,40€				
100	XR100	81-85	41251072	31,60€					41251300	27,60€				
100	XRR100	85-04	41251027	13,90€	FWKH034	19,90€			41251191	12,40€				
110	CRF 110	13-21	41251027	13,90€	FWKH034	19,90€			41251191	12,40€				
125	CR125 R	81-81	41251038	11,60€										
125	CR125 R	82-82	41251119	25,90€					41251113	38,30€				
125	CR125 R	83-83	41251119	25,90€					41251115	22,80€				
125	CR125 R	84-84	41251073	32,40€					41251115	22,80€				
125	CR125 R	85-86	41251075	18,70€					41251115	22,80€				
125	CR125 R	87-88	41251075	18,70€					41251241	20,40€				
125	CR125 R	89-89	41251075	18,70€			41111096	49,80€	41251204	32,10€			411110131	91,30€
125	CR125 R	90-91	41251075	18,70€			41111096	49,80€	41251202	24,20€			411110131	91,30€
125	CR125 R	92-94	41251075	18,70€			41111002	57,40€	41251202	24,20€	RWKH191	28,90€	411110131	91,30€
125	CR125 R	95-95	41251081	27,90€	FWKH033	28,90€	41111003	62,00€	41251202	24,20€	RWKH191	28,90€	411110141	91,30€
125	CR125 R	96-99	41251081	27,90€	FWKH033	28,90€	41111004	81,70€	41251202	24,20€	RWKH191	28,90€	411110141	91,30€
125	CR125 R	00-01	41251081	27,90€	FWKH033	28,90€	41111004	81,70€	41251250	29,40€	RWKH193	28,90€	411110151	74,50€
125	CR125 R	02-07	41251081	27,90€	FWKH033	28,90€	41111005	58,00€	41251250	29,40€	RWKH193	28,90€	411110151	74,50€
125	CRF125 F	14-21	41251027	13,90€	FWKH034	19,90€			41251191	12,40€				
125	TRX 125 Fourtrax	85-87	41251052	29,40€										
150	CRF150 F	03-09	41251421	32,90€			41111006	32,50€	41251422	34,40€			41111016	14,80€
150	CRF150 F	10-14	41251421	32,90€					41251422	34,40€				
150	CRF150 R	07-15	41251539	32,90€					41251540	40,40€				
200	TRX 200	84-84	41251510	20,40€										
200	TRX200 (Type2)	97-97	41251510	20,40€										
230	CRF230 F	03-03	41251421	32,90€					41251422	34,40€				
230	CRF230 F	04-14	41251421	32,90€			41111006	32,50€	41251422	34,40€			41111016	14,80€
250	CR250 R	88-88	41251075	18,70€			41111096	49,80€	41251241	20,40€			411110131	91,30€
250	CR250 R	89-89	41251075	18,70€			41111096	49,80€	41251203	67,20€			411110131	91,30€
250	CR250 R	90-91	41251075	18,70€			41111096	49,80€	41251202	24,20€			411110131	91,30€
250	CR250 R	92-94	41251075	18,70€			41111002	57,40€	41251202	24,20€	RWKH191	28,90€	411110131	91,30€
250	CR250 R	95-95	41251081	27,90€	FWKH033	28,90€	41111003	62,00€	41251202	24,20€	RWKH191	28,90€	411110141	91,30€
250	CR250 R	96-99	41251081	27,90€	FWKH033	28,90€	41111004	81,70€	41251202	24,20€	RWKH191	28,90€	411110141	91,30€
250	CR250 R	00-01	41251081	27,90€	FWKH033	28,90€	41111004	81,70€	41251250	29,40€	RWKH193	28,90€	411110151	74,50€
250	CR250 R	02-08	41251081	27,90€	FWKH033	28,90€	41111005	58,00€	41251250	29,40€	RWKH193	28,90€	411110151	74,50€
250	CRF250 R	04-22	41251081	27,90€	FWKH033	28,90€	41111005	58,00€	41251250	29,40€	RWKH193	28,90€	411110151	74,50€
250	CRF250 RX	20-22	41251081	27,90€	FWKH033	28,90€	41111005	58,00€	41251250	29,40€	RWKH193	28,90€	411110151	74,50€
250	CRF250 X	04-15	41251521	60,40€			41111007	23,10€	41251250	29,40€	RWKH193	28,90€	411110151	74,50€
300	CRF300 RX	21-22	41251081	27,90€	FWKH033	28,90€	41111005	58,00€	41251250	29,40€	RWKH193	28,90€	411110151	74,50€
350	TRX350 FE /TE /FM	00-06	41251510	20,40€										
400	CRF400 RX	21-22	41251081	27,90€	FWKH033	28,90€	41111005	58,00€	41251250	29,40€	RWKH193	28,90€	411110151	74,50€
400	XR400 R	96-04	41251076	32,50€			41111009	27,00€	41251206	20,70€			41111020	67,70€
400	XR400 R	05-06	41251076	32,50€					41251206	20,70€				
450	CRF450 R	02-22	41251081	27,90€	FWKH033	28,90€	41111005	58,00€	41251250	29,40€	RWKH193	28,90€	411110151	74,50€









Cyl.	Modèle	Années	ROUE AVANT						ROUE ARRIERE					
			ROULEMENTS ET JOINTS		ROULEMENTS		ENTRETOISES		ROULEMENTS ET JOINTS		ROULEMENTS		ENTRETOISES	
				€T.T.C.		€T.T.C.		€T.T.C.		€T.T.C.		€T.T.C.		€T.T.C.
450	CRF450 RX	17-17	41251521	60,40€	FWKH047	28,90€	41111005	58,00€	41251250	29,40€	RWKH193	28,90€	411110151	74,50€
450	CRF450 RX	18-22	41251081	27,90€	FWKH033	28,90€	41111005	58,00€	41251250	29,40€	RWKH193	28,90€	411110151	74,50€
450	CRF450 X	05-17	41251521	60,40€	FWKH047	28,90€	41111007	23,10€	41251250	29,40€	RWKH193	28,90€	411110151	74,50€
450	CRF450 X	18-18	41251081	27,90€	FWKH033	28,90€	41111007	23,10€	41251250	29,40€	RWKH193	28,90€	411110151	74,50€
450	CRF450 X	19-20	41251081	27,90€	FWKH033	28,90€	41111005	58,00€	41251250	29,40€	RWKH193	28,90€	411110151	74,50€
480	CR480 R	82-83	41251119	25,90€					41251113	38,30€				
500	CR500 R	84-84	41251073	32,40€					41251115	22,80€				
500	CR500 R	85-86	41251075	18,70€					41251115	22,80€				
500	CR500 R	87-87	41251075	18,70€					41251241	20,40€			411110181	89,60€
500	CR500 R	88-88	41251075	18,70€			41111096	49,80€	41251241	20,40€			411110131	91,30€
500	CR500 R	89-89	41251075	18,70€			41111096	49,80€	41251203	67,20€			411110131	91,30€
500	CR500 R	90-91	41251075	18,70€			41111096	49,80€	41251202	24,20€			411110131	91,30€
500	CR500 R	92-94	41251075	18,70€			41111002	57,40€	41251202	24,20€	RWKH191	28,90€	411110131	91,30€
500	CR500 R	95-95	41251081	27,90€	FWKH033	28,90€	41111003	62,00€	41251202	24,20€	RWKH191	28,90€	411110131	91,30€
500	CR500 R	96-01	41251081	27,90€	FWKH033	28,90€	41111004	81,70€	41251202	24,20€	RWKH191	28,90€	411110131	91,30€
500	CR500 R	02-02	41251081	27,90€	FWKH033	28,90€			41251202	24,20€	RWKH191	28,90€		
500	XR500 R	81-82	41251120	26,00€					41251214	34,90€				
500	XR500 R	83-84	41251069	16,20€					41251214	34,90€				
600	XR600 R	85-90	41251069	16,20€					41251217	34,70€				
600	XR600 R [FR]	91-92	41251069	16,20€					41251217	34,70€				
600	XR600 R [FR]	93-00	41251076	32,50€					41251217	34,70€				
650	XR650 L [US]	93-13	41251076	32,50€			41111009	27,00€	41251214	34,90€				
650	XR650 R	00-07	41251076	32,50€			41111009	27,00€	41251113	38,30€			411110221	75,50€
HUSABERG														
125	TE125 2T	12-13											41111087	35,50€
250	FE250 4T	13-14	41251402	29,30€	FWKT022	28,90€	41111087	35,50€	41251273	24,80€	RWKT039	24,90€		
250	TE250 2T	11-14	41251402	29,30€	FWKT022	28,90€	41111087	35,50€	41251273	24,80€	RWKT039	24,90€	411110841	28,80€
300	TE300 2T	13-14	41251402	29,30€	FWKT022	28,90€	41111087	35,50€	41251273	24,80€	RWKT039	24,90€	411110841	28,80€
350	FE350 4T	13-14	41251402	29,30€	FWKT022	28,90€	41111087	35,50€	41251273	24,80€	RWKT039	24,90€	411110841	28,80€
350	TE350	14-14											41111087	35,50€
390	FE390 Enduro	10-11	41251402	29,30€	FWKT022	28,90€	41111087	35,50€	41251273	24,80€	RWKT039	24,90€	411110841	28,80€
450	FC450	04-05	41251402	29,30€	FWKT022	28,90€	41111087	35,50€	41251273	24,80€	RWKT039	24,90€	411110841	28,80€
450	FE450	09-11	41251402	29,30€	FWKT022	28,90€	41111087	35,50€	41251273	24,80€	RWKT039	24,90€	411110841	28,80€
450	FE450	12-14	41251402	29,30€	FWKT022	28,90€			41251273	24,80€	RWKT039	24,90€		
450	FE450 E	04-08	41251402	29,30€	FWKT022	28,90€	41111087	35,50€	41251273	24,80€	RWKT039	24,90€	411110841	28,80€
450	FS450 E /C	03-03	41251402	29,30€	FWKT022	28,90€			41251283	122,30€				
450	FS450 E /C	04-04	41251402	29,30€	FWKT022	28,90€	41111087	35,50€	41251283	122,30€	RWKT039	24,90€		
450	FS450 E /C	05-06	41251402	29,30€	FWKT022	28,90€	41111087	35,50€			RWKT039	24,90€	411110841	28,80€
450	FS450 E /C	07-08	41251402	29,30€	FWKT022	28,90€					RWKT039	24,90€		
501	FE501	13-14	41251402	29,30€	FWKT022	28,90€			41251273	24,80€	RWKT039	24,90€		
550	FC550	04-05			FWKT022	28,90€					RWKT039	24,90€		
550	FE550 /E	04-06			FWKT022	28,90€								
550	FE550 /E	07-08			FWKT022	28,90€					RWKT039	24,90€		
570	FE570 Enduro	09-10			FWKT022	28,90€					RWKT039	24,90€		
650	FE650 E	04-08	41251402	29,30€	FWKT022	28,90€			41251283	122,30€	RWKT039	24,90€		
650	FS650 C /E	04-08	41251402	29,30€	FWKT022	28,90€			41251283	122,30€	RWKT039	24,90€		
HUSQVARNA														
50	TC 50	18-22	41251135	10,30€	FWKT025	19,90€			41251711	14,20€				
50	TC 50 Mini	19-22	41251135	10,30€	FWKT025	19,90€			41251711	14,20€				
65	CR 65	12-14	41251135	10,30€	FWKT025	19,90€			41251348	26,90€				
65	TC 65	17-22	41251135	10,30€	FWKT025	19,90€			41251345	14,10€	RWKT040	38,90€		
85	TC 85	14-22	41251406	29,30€			411111051	40,30€	41251273	24,80€	RWKT039	24,90€	411110841	28,80€
125	CR125	96-97	41251417	29,80€										
125	CR125	98-99	41251417	29,80€										
125	CR125	00-00	41251426	35,50€					41251420	37,20€	RWKQ011	47,90€		
125	CR125	01-11	41251415	55,60€	FWKQ001	36,90€			41251420	37,20€	RWKQ011	47,90€		
125	CR125	12-12	41251661	63,70€	FWKQ001	36,90€			41251420	37,20€	RWKQ011	47,90€		
125	CR125	13-13	41251661	63,70€					41251420	37,20€	RWKQ011	47,90€		
125	TC125 2T	13-14	41251402	29,30€	FWKT022	28,90€	41111087	35,50€	41251273	24,80€	RWKT039	24,90€	411110841	28,80€







Cyl.	Modèle	Années	ROUE AVANT						ROUE ARRIERE					
			ROULEMENTS ET JOINTS		ROULEMENTS		ENTRETOISES		ROULEMENTS ET JOINTS		ROULEMENTS		ENTRETOISES	
				€T.T.C.		€T.T.C.		€T.T.C.		€T.T.C.		€T.T.C.		€T.T.C.
HUSQVARNA														
125	TC125 2T	15-15	41251402	29,30€	FWKT022	28,90€	41111031	30,70€	41251273	24,80€	RWKT039	24,90€	411110841	28,80€
125	TC125 2T	16-22	41251402	29,30€	FWKT022	28,90€	41111031	30,70€	41251273	24,80€	RWKT039	24,90€	41111021	58,80€
125	TE125 2T	13-16	41251402	29,30€	FWKT022	28,90€	41111087	35,50€	41251273	24,80€	RWKT039	24,90€	411110841	28,80€
125	TE125 4T	14-14	41251402	29,30€	FWKT022	28,90€			41251273	24,80€	RWKT039	24,90€		
125	TX125 2T	17-19	41251402	29,30€	FWKT022	28,90€			41251273	24,80€	RWKT039	24,90€		
125	WR125	96-98	41251417	29,80€										
125	WR125	99-99	41251417	29,80€										
125	WR125	00-00	41251413	35,50€					41251420	37,20€	RWKQ011	47,90€		
125	WR125	01-01	41251427	35,50€					41251420	37,20€	RWKQ011	47,90€		
125	WR125	02-13	41251415	55,60€	FWKQ001	36,90€			41251420	37,20€	RWKQ011	47,90€		
125	WRE125	94-95	41251147	15,10€										
150	TE150i	20-22	41251402	29,30€	FWKT022	28,90€	41111031	69,90€	41251273	24,80€	RWKT039	24,90€	411110841	28,80€
250	CR250	96-98	41251417	29,80€										
250	CR250	99-99	41251417	29,80€										
250	CR250	00-03	41251426	35,50€					41251420	37,20€	RWKQ011	47,90€		
250	CR250	04-04	41251426	35,50€	FWKQ001	36,90€			41251420	37,20€	RWKQ011	47,90€		
250	CR250	05-05	41251426	35,50€					41251420	37,20€	RWKQ011	47,90€		
250	FC 250	14-14	41251402	29,30€	FWKT022	28,90€	41111087	35,50€	41251273	24,80€	RWKT039	24,90€	411110841	28,80€
250	FC 250	15-22	41251402	29,30€	FWKT022	28,90€	41111031	69,90€	41251273	24,80€	RWKT039	24,90€	41111021	58,80€
250	FE250	14-14	41251402	29,30€	FWKT022	28,90€	41111087	35,50€	41251273	24,80€	RWKT039	24,90€	411110841	28,80€
250	FE250	15-22	41251402	29,30€	FWKT022	28,90€	41111031	69,90€	41251273	24,80€	RWKT039	24,90€	41111021	58,80€
250	TC250	03-11	41251415	55,60€	FWKQ001	36,90€			41251420	37,20€	RWKQ011	47,90€		
250	TC250	12-13	41251661	63,70€					41251420	37,20€	RWKQ011	47,90€		
250	TC250	14-14	41251402	29,30€	FWKT022	28,90€	41111087	35,50€	41251273	24,80€	RWKT039	24,90€	411110841	28,80€
250	TC250	15-22	41251402	29,30€	FWKT022	28,90€	41111031	69,90€	41251273	24,80€	RWKT039	24,90€	41111021	58,80€
250	TE250	03-11	41251415	55,60€	FWKQ001	36,90€			41251420	37,20€	RWKQ011	47,90€		
250	TE250	12-12	41251661	63,70€	FWKQ001	36,90€			41251420	37,20€	RWKQ011	47,90€		
250	TE250	13-13	41251661	63,70€					41251420	37,20€	RWKQ011	47,90€		
250	TE250	14-15	41251402	29,30€	FWKT022	28,90€	41111087	35,50€	41251273	24,80€	RWKT039	24,90€	411110841	28,80€
250	TE250	16-16	41251402	29,30€	FWKT022	28,90€	41111031	69,90€	41251273	24,80€	RWKT039	24,90€	411110841	28,80€
250	TE250	17-17	41251402	29,30€	FWKT022	28,90€	41111031	69,90€	41251273	24,80€	RWKT039	24,90€	41111021	58,80€
250	TE250i	18-18	41251402	29,30€	FWKT022	28,90€	41111031	69,90€	41251273	24,80€	RWKT039	24,90€	41111021	58,80€
250	TE250i	19-22	41251402	29,30€	FWKT022	28,90€	41111031	69,90€	41251273	24,80€	RWKT039	24,90€	411110841	28,80€
250	WR250	96-98	41251417	29,80€										
250	WR250	99-99	41251417	29,80€										
250	WR250	00-00	41251413	35,50€					41251420	37,20€	RWKQ011	47,90€		
250	WR250	01-01	41251427	35,50€					41251420	37,20€	RWKQ011	47,90€		
250	WR250	02-03	41251414	50,90€					41251420	37,20€	RWKQ011	47,90€		
250	WR250	04-12	41251414	50,90€	FWKQ001	36,90€			41251420	37,20€	RWKQ011	47,90€		
250	WR250	13-13	41251414	50,90€					41251420	37,20€	RWKQ011	47,90€		
300	TE300	14-15	41251402	29,30€	FWKT022	28,90€	41111087	35,50€	41251273	24,80€	RWKT039	24,90€	411110841	28,80€
300	TE300	16-17	41251402	29,30€	FWKT022	28,90€	41111031	69,90€	41251273	24,80€	RWKT039	24,90€	411110841	28,80€
300	TE300i	18-22	41251402	29,30€	FWKT022	28,90€	41111031	69,90€	41251273	24,80€	RWKT039	24,90€	411110841	28,80€
300	WR300	09-13	41251415	55,60€	FWKQ001	36,90€			41251420	37,20€	RWKQ011	47,90€		
310	TE310	08-11	41251415	55,60€	FWKQ001	36,90€			41251420	37,20€	RWKQ011	47,90€		
310	TE310	12-13	41251661	63,70€					41251420	37,20€	RWKQ011	47,90€		
350	FC 350	14-14	41251402	29,30€	FWKT022	28,90€	41111087	35,50€	41251273	24,80€	RWKT039	24,90€	411110841	28,80€
350	FC 350	15-15	41251402	29,30€	FWKT022	28,90€	41111031	69,90€	41251273	24,80€	RWKT039	24,90€	411110841	28,80€
350	FC 350	16-22	41251402	29,30€	FWKT022	28,90€	41111031	69,90€	41251273	24,80€	RWKT039	24,90€	41111021	58,80€
350	FE 350	14-18	41251402	29,30€	FWKT022	28,90€	41111087	35,50€	41251273	24,80€	RWKT039	24,90€	411110841	28,80€
350	FE 350	19-22	41251402	29,30€	FWKT022	28,90€	41111031	30,70€	41251273	24,80€	RWKT039	24,90€	411110841	28,80€
350	TE350	95-95	41251417	29,80€										
360	WR360	96-98	41251417	29,80€										
360	WR360	99-99	41251417	29,80€										
360	WR360	00-00	41251413	35,50€					41251420	37,20€	RWKQ011	47,90€		
360	WR360	01-01	41251427	35,50€					41251420	37,20€	RWKQ011	47,90€		
360	WR360	02-02	41251414	50,90€					41251420	37,20€	RWKQ011	47,90€		
400	TE400	98-02	41251413	35,50€					41251420	37,20€	RWKQ011	47,90€		









Cyl.	Modèle	Années	ROUE AVANT						ROUE ARRIERE						
			ROULEMENTS ET JOINTS		ROULEMENTS		ENTRETOISES		ROULEMENTS ET JOINTS		ROULEMENTS		ENTRETOISES		
				€T.T.C.		€T.T.C.		€T.T.C.		€T.T.C.		€T.T.C.		€T.T.C.	
410	TE410	96-98	41251417	29,80€											
410	TE410	99-99	41251417	29,80€											
410	TE410	00-01	41251417	29,80€						41251420	37,20€	RWKQ011	47,90€		
450	FC 450	14-14	41251402	29,30€	FWKT022	28,90€	41111087	35,50€	41251273	24,80€	RWKT039	24,90€	411110841	28,80€	
450	FC 450	15-22	41251402	29,30€	FWKT022	28,90€	41111031	69,90€	41251273	24,80€	RWKT039	24,90€	41111021	58,80€	
450	FE 450	14-16	41251402	29,30€	FWKT022	28,90€	41111087	35,50€	41251273	24,80€	RWKT039	24,90€	411110841	28,80€	
450	FE 450	17-18	41251402	29,30€	FWKT022	28,90€	41111031	69,90€	41251273	24,80€	RWKT039	24,90€	41111021	58,80€	
450	FE 450	19-22	41251402	29,30€	FWKT022	28,90€	41111031	69,90€	41251273	24,80€	RWKT039	24,90€	411110841	28,80€	
450	FS 450	15-22	41251402	29,30€	FWKT022	28,90€			41251273	24,80€	RWKT039	24,90€			
450	TC450	03-10	41251415	55,60€	FWKQ001	36,90€			41251420	37,20€	RWKQ011	47,90€			
450	TC450	11-14	41251661	63,70€					41251420	37,20€	RWKQ011	47,90€			
450	TE450	03-10	41251415	55,60€	FWKQ001	36,90€			41251420	37,20€	RWKQ011	47,90€			
450	TE450	11-13	41251661	63,70€					41251420	37,20€	RWKQ011	47,90€			
501	FE 501	14-16	41251402	29,30€	FWKT022	28,90€	41111087	35,50€	41251273	24,80€	RWKT039	24,90€	411110841	28,80€	
501	FE 501	17-17	41251402	29,30€	FWKT022	28,90€	41111031	30,70€	41251273	24,80€	RWKT039	24,90€	411110841	28,80€	
501	FE 501	18-22	41251402	29,30€	FWKT022	28,90€	41111031	30,70€	41251273	24,80€	RWKT039	24,90€	41111021	58,80€	
510	SMR510	04-12	41251415	55,60€	FWKQ001	36,90€			41251420	37,20€	RWKQ011	47,90€			
510	TC510	04-10	41251415	55,60€	FWKQ001	36,90€			41251420	37,20€	RWKQ011	47,90€			
510	TE510	04-10	41251415	55,60€	FWKQ001	36,90€			41251420	37,20€	RWKQ011	47,90€			
510	TE510	11-13									RWKQ011	47,90€			
570	TC570	01-02	41251415	55,60€	FWKQ001	36,90€			41251420	37,20€	RWKQ011	47,90€			
570	TE570	01-02	41251415	55,60€	FWKQ001	36,90€			41251420	37,20€	RWKQ011	47,90€			
610	TC610	96-98	41251417	29,80€											
610	TC610	99-99	41251417	29,80€											
610	TC610	00-00	41251413	35,50€					41251420	37,20€	RWKQ011	47,90€			
610	TC610	01-01	41251415	55,60€	FWKQ001	36,90€			41251420	37,20€	RWKQ011	47,90€			
610	TE610	96-98	41251417	29,80€											
610	TE610	99-99	41251417	29,80€											
610	TE610	00-00	41251413	35,50€					41251420	37,20€	RWKQ011	47,90€			
610	TE610	01-01	41251416	31,30€					41251420	37,20€	RWKQ011	47,90€			
610	TE610	02-03	41251417	29,80€											
610	TE610	04-04	41251417	29,80€							RWKQ011	47,90€			
610	TE610	05-05	41251415	55,60€	FWKQ001	36,90€					RWKQ011	47,90€			
610	TE610	06-09	41251415	55,60€	FWKQ001	36,90€			41251420	37,20€	RWKQ011	47,90€			
610	TE610 E	99-99	41251417	29,80€											
610	TE610 E	00-01	41251413	35,50€											
693	Enduro 701	16-22	41251402	29,30€	FWKT022	28,90€	41111087	35,50€	41251533	35,50€					
KAWASAKI															
50	KFX50 (KSF [US])	02-06	41251194	29,20€											
60	KX60	83-99	41251165	25,30€					41251181	17,00€	FWKK031	19,90€			
65	KX65	00-22	41251181	17,00€	FWKK031	19,90€	41111024	32,50€	41251181	17,00€	FWKK031	19,90€	41111033	16,00€	
80	KFX80 (KSF[US])	03-06	41251194	29,20€											
80	KX80	89-91	41251177	18,20€					41251171	15,80€			41111035	39,20€	
80	KX80	92-97	41251171	15,80€					41251171	15,80€			41111035	39,20€	
80	KX80	98-00	41251181	17,00€	FWKK031	19,90€	41111025	54,00€	41251033	26,50€			41111036	55,30€	
85	KX85	01-22	41251181	17,00€	FWKK031	19,90€	41111025	54,00€	41251033	26,50€	RWKK119	28,90€	41111036	55,30€	
110	KLX110	02-21	41251165	25,30€			41111023	10,15€	41251400	37,70€			41111037	17,40€	
125	KX125	82-82	41251194	29,20€					41251345	14,10€	RWKT040	38,90€			
125	KX125	83-84	41251194	29,20€											
125	KX125	85-85	41251093	19,30€											
125	KX125	86-88	41251093	19,30€					41251223	21,60€					
125	KX125	89-89	41251093	19,30€					41251223	21,60€			41111039	76,60€	
125	KX125	90-92	41251093	19,30€			41111094	33,60€	41251223	21,60€			41111040	74,00€	
125	KX125	93-96	41251079	27,90€	FWKK029	28,90€	41111027	32,20€	41251223	21,60€			41111040	74,00€	
125	KX125	97-98	41251079	27,90€	FWKK029	28,90€	41111027	32,20€	41251224	23,10€	RWKK117	19,90€	41111041	74,00€	
125	KX125	99-02	41251079	27,90€	FWKK029	28,90€	41111028	44,80€	41251224	23,10€	RWKK117	19,90€	41111041	74,00€	
125	KX125	03-03	41251079	27,90€	FWKK029	28,90€	41111028	44,80€	41251406	29,30€	RWKK123	28,90€	411110421	78,40€	
125	KX125	04-05	41251079	27,90€	FWKK029	28,90€	41111029	33,60€	41251406	29,30€	RWKK123	28,90€	411110421	78,40€	
125	KX125	06-08	41251079	27,90€					41251406	29,30€	RWKK123	28,90€			







Cyl.	Modèle	Années	ROUE AVANT				ROUE ARRIERE							
			ROULEMENTS ET JOINTS		ROULEMENTS		ENTRETOISES		ROULEMENTS ET JOINTS		ROULEMENTS		ENTRETOISES	
				€T.T.C.		€T.T.C.		€T.T.C.		€T.T.C.		€T.T.C.		€T.T.C.
KAWASAKI														
200	KDX200	92-92	41251444	11,80€					41251223	21,60€				
200	KDX200	93-06	41251745	17,00€			41111030	29,50€	41251223	21,60€			41111039	76,60€
250	KDX250	91-93	41251147	15,10€			41111030	29,50€	41251346	27,70€			41111039	76,60€
250	KDX250	94-94	41251143	9,10€			41111030	29,50€	41251345	14,10€	RWKT040	38,90€	41111039	76,60€
250	KLX250 R	93-93					41111030	29,50€					41111039	76,60€
250	KLX250 R	94-98	41251745	17,00€			41111030	29,50€	41251223	21,60€			41111039	76,60€
250	KLX250 S /SF	09-17							41251223	21,60€			41111043	86,50€
250	KX250	82-83	41251142	14,80€					41251345	14,10€	RWKT040	38,90€		
250	KX250	84-84	41251194	29,20€					41251345	14,10€	RWKT040	38,90€		
250	KX250	85-85	41251093	19,30€										
250	KX250	86-88	41251093	19,30€					41251223	21,60€				
250	KX250	89-89	41251093	19,30€					41251223	21,60€			41111039	76,60€
250	KX250	90-92	41251093	19,30€			41111094	33,60€	41251223	21,60€			41111040	74,00€
250	KX250	93-96	41251079	27,90€	FWKK029	28,90€	41111027	32,20€	41251223	21,60€			41111040	74,00€
250	KX250	97-98	41251079	27,90€	FWKK029	28,90€	41111027	32,20€	41251224	23,10€	RWKK117	19,90€	41111041	74,00€
250	KX250	99-02	41251079	27,90€	FWKK029	28,90€	41111028	44,80€	41251224	23,10€	RWKK117	19,90€	41111041	74,00€
250	KX250	03-03	41251079	27,90€	FWKK029	28,90€	41111028	44,80€	41251406	29,30€	RWKK123	28,90€	411110421	78,40€
250	KX250	04-05	41251079	27,90€	FWKK029	28,90€	41111029	33,60€	41251406	29,30€	RWKK123	28,90€	411110421	78,40€
250	KX250	06-08	41251079	27,90€	FWKK029	28,90€	41111031	69,90€	41251406	29,30€	RWKK123	28,90€	411110421	78,40€
250	KX250 F	04-05	41251079	27,90€	FWKK029	28,90€	41111029	33,60€	41251406	29,30€	RWKK123	28,90€	411110421	78,40€
250	KX250 F	06-18	41251079	27,90€	FWKK029	28,90€	41111031	69,90€	41251406	29,30€	RWKK123	28,90€	411110421	78,40€
250	KX250 F - KX	19-20	41251079	27,90€	FWKK029	28,90€	41111031	69,90€	41251406	29,30€	RWKK123	28,90€	411110421	78,40€
250	KX250 F - KX	21-22	41251482	33,60€	FWKK029	28,90€	41111108	37,30€	41251406	29,30€	RWKK123	28,90€	411110421	78,40€
250	KX250X Enduro (KL)	22-22	41251482	33,60€	FWKK029	28,90€	41111108	37,30€	41251406	29,30€	RWKK123	28,90€	411110421	78,40€
300	KLF300 Bayou	86-87	41251070	20,40€										
300	KLX300 R	97-07	41251745	17,00€			41111030	29,50€	41251223	21,60€			41111043	86,50€
360	KVF360 Prairie 2x4	03-07	41251444	11,80€			41111030	29,50€	41251223	21,60€			41111043	86,50€
450	KLX450 R	05-07					41111098	32,10€	41251406	29,30€			411110421	78,40€
450	KLX450 R	08-09			FWKK029	28,90€	41111098	32,10€	41251406	29,30€	RWKK123	28,90€	411110421	78,40€
450	KLX450 R	10-15					41111098	32,10€	41251406	29,30€			411110421	78,40€
450	KX450 F	06-18	41251079	27,90€	FWKK029	28,90€	41111031	69,90€	41251406	29,30€	RWKK123	28,90€	411110421	78,40€
450	KX450 F - KX	19-22	41251482	33,60€	FWKS047	28,90€	41111108	37,30€	41251406	29,30€	RWKK123	28,90€	411110421	78,40€
450	KX450 X Enduro (KL)	22-22	41251482	33,60€			41111108	37,30€	41251406	29,30€	RWKK123	28,90€	411110421	78,40€
500	KX500	84-84	41251194	29,20€					41251345	14,10€	RWKT040	38,90€		
500	KX500	85-85	41251093	19,30€					41251093	19,30€				
500	KX500	86-88	41251093	19,30€					41251223	21,60€				
500	KX500	89-89	41251093	19,30€					41251223	21,60€			41111039	76,60€
500	KX500	90-93	41251093	19,30€			41111094	33,60€	41251223	21,60€			41111040	74,00€
500	KX500	94-96	41251079	27,90€	FWKK029	28,90€	41111027	32,20€	41251224	23,10€			41111040	74,00€
500	KX500	97-04	41251079	27,90€	FWKK029	28,90€	41111027	32,20€	41251224	23,10€	RWKK117	19,90€	41111041	74,00€
620	KAF620 MULE	09-09	41251404	24,70€										
650	KLX650 C	93-95	41251745	17,00€			41111030	29,50€	41251099	61,70€				
650	KLX650 R	93-95	41251745	17,00€			41111030	29,50€	41251223	21,60€			41111039	76,60€
650	KLX650 R	96-01	41251745	17,00€			41111030	29,50€	41251223	21,60€			41111043	86,50€
KTM														
0	SX-E	19-22	41251135	10,30€	FWKT025	19,90€			41251711	14,20€				
50	Mini Adventure 50	98-00	41251009	15,80€					41251009	15,80€				
50	Mini Adventure 50	02-07	41251009	15,80€					41251009	15,80€				
50	Supermoto 50 SM	06-06	41251143	9,10€					41251143	9,10€				
50	SX50	06-11	41251143	9,10€					41251143	9,10€				
50	SX50	12-14	41251135	10,30€	FWKT025	19,90€			41251143	9,10€				
50	SX50	15-22	41251135	10,30€	FWKT025	19,90€			41251711	14,20€				
50	SX50 Junior	06-15	41251143	9,10€					41251143	9,10€				
50	SX50 Mini	19-22	41251135	10,30€	FWKT025	19,90€			41251711	14,20€				
50	SX50 Pro Junior	97-01	41251009	15,80€					41251009	15,80€				
50	SX50 Pro Junior LC	02-05	41251143	9,10€					41251009	15,80€				
50	SX50 Pro Junior LC	06-06	41251143	9,10€					41251143	9,10€				
50	SX50 Pro Senior	97-99	41251009	15,80€					41251009	15,80€				









Cyl.	Modèle	Années	ROUE AVANT						ROUE ARRIERE						
			ROULEMENTS ET JOINTS		ROULEMENTS		ENTRETOISES		ROULEMENTS ET JOINTS		ROULEMENTS		ENTRETOISES		
				€T.T.C.		€T.T.C.		€T.T.C.		€T.T.C.		€T.T.C.		€T.T.C.	
50	SX50 Pro Senior LC	02-05	41251143	9,10€						41251009	15,80€				
50	SX50 Senior Adventure	03-07	41251143	9,10€						41251143	9,10€				
60	SX60	98-01	41251135	10,30€	FWKT025	19,90€				41251348	26,90€				
65	SX65	00-22	41251135	10,30€	FWKT025	19,90€				41251345	14,10€	RWKT040	38,90€		
85	SX85	03-11	41251063	17,30€			41111083	25,70€		41251273	24,80€	RWKT039	24,90€	411110841	28,80€
85	SX85	12-22	41251406	29,30€			411111051	40,30€		41251273	24,80€	RWKT039	24,90€	411110841	28,80€
125	EGS125	93-99	41251061	34,70€			41111085	18,30€		41251273	24,80€	RWKT039	24,90€	411110841	28,80€
125	EXC125 Enduro	95-99	41251061	34,70€			41111085	18,30€		41251273	24,80€	RWKT039	24,90€	411110841	28,80€
125	EXC125 Enduro	00-02	41251080	30,10€	FWKT021	28,90€	41111088	17,60€		41251273	24,80€	RWKT039	24,90€	411110841	28,80€
125	EXC125 Enduro	03-09	41251402	29,30€	FWKT022	28,90€	41111087	35,50€		41251273	24,80€	RWKT039	24,90€	411110841	28,80€
125	EXC125 Enduro	10-18	41251402	29,30€	FWKT022	28,90€				41251273	24,80€	RWKT039	24,90€		
125	SX125	93-93	41251063	17,30€						41251273	24,80€	RWKT039	24,90€	411110841	28,80€
125	SX125	94-99	41251063	17,30€			41111086	35,80€		41251273	24,80€	RWKT039	24,90€	411110841	28,80€
125	SX125	00-02	41251081	27,90€	FWKT020	28,90€	41111089	34,30€		41251273	24,80€	RWKT039	24,90€	411110841	28,80€
125	SX125	03-03	41251402	29,30€	FWKT022	28,90€	41111087	35,50€		41251273	24,80€	RWKT039	24,90€	411110841	28,80€
125	SX125	04-04	41251402	29,30€	FWKT022	28,90€	41111067	53,80€		41251273	24,80€	RWKT039	24,90€	411110841	28,80€
125	SX125	05-12	41251402	29,30€	FWKT022	28,90€	41111087	35,50€		41251273	24,80€	RWKT039	24,90€	411110841	28,80€
125	SX125	13-14	41251402	29,30€	FWKT022	28,90€	41111087	35,50€		41251273	24,80€	RWKT039	24,90€	41111021	58,80€
125	SX125	15-22	41251402	29,30€	FWKT022	28,90€	411111031	30,70€		41251273	24,80€	RWKT039	24,90€	41111021	58,80€
125	XC125 W Enduro	19-19	41251402	29,30€	FWKT022	28,90€	411111031	30,70€		41251273	24,80€	RWKT039	24,90€	41111021	58,80€
150	EXC150 TPI Enduro	20-22	41251402	29,30€	FWKT022	28,90€	411111031	30,70€		41251273	24,80€	RWKT039	24,90€	411110841	28,80€
150	SX144	07-08	41251402	29,30€	FWKT022	28,90€	41111087	35,50€		41251273	24,80€	RWKT039	24,90€	411110841	28,80€
150	SX150	09-12	41251402	29,30€	FWKT022	28,90€	41111087	35,50€		41251273	24,80€	RWKT039	24,90€	411110841	28,80€
150	SX150	13-14	41251402	29,30€	FWKT022	28,90€	41111087	35,50€		41251273	24,80€	RWKT039	24,90€	41111021	58,80€
150	SX150	15-22	41251402	29,30€	FWKT022	28,90€	411111031	30,70€		41251273	24,80€	RWKT039	24,90€	41111021	58,80€
200	EGS200	98-99	41251061	34,70€			41111085	18,30€		41251273	24,80€	RWKT039	24,90€	411110841	28,80€
200	EXC200 Enduro	98-98	41251061	34,70€			41111085	18,30€		41251273	24,80€	RWKT039	24,90€	411110841	28,80€
200	EXC200 Enduro	99-99	41251061	34,70€			411110581	81,70€		41251273	24,80€	RWKT039	24,90€	411110841	28,80€
200	EXC200 Enduro	00-02	41251080	30,10€	FWKT021	28,90€	41111088	17,60€		41251273	24,80€	RWKT039	24,90€	411110841	28,80€
200	EXC200 Enduro	03-05	41251402	29,30€	FWKT022	28,90€	41111087	35,50€		41251273	24,80€	RWKT039	24,90€	411110841	28,80€
200	EXC200 Enduro	06-16	41251402	29,30€	FWKT022	28,90€				41251273	24,80€	RWKT039	24,90€		
200	SX200	00-02	41251081	27,90€	FWKT020	28,90€	41111089	34,30€		41251273	24,80€	RWKT039	24,90€	411110841	28,80€
200	SX200	03-06	41251402	29,30€	FWKT022	28,90€	41111087	35,50€		41251273	24,80€	RWKT039	24,90€	411110841	28,80€
250	EGS250	94-99	41251061	34,70€			41111085	18,30€		41251273	24,80€	RWKT039	24,90€	411110841	28,80€
250	EXC250 Enduro	95-99	41251061	34,70€			41111085	18,30€		41251273	24,80€	RWKT039	24,90€	411110841	28,80€
250	EXC250 Enduro	00-02	41251080	30,10€	FWKT021	28,90€	41111088	17,60€		41251273	24,80€	RWKT039	24,90€	411110841	28,80€
250	EXC250 Enduro	03-03	41251402	29,30€	FWKT022	28,90€	41111067	53,80€		41251273	24,80€	RWKT039	24,90€	411110841	28,80€
250	EXC250 Enduro	04-12	41251402	29,30€	FWKT022	28,90€	41111087	35,50€		41251273	24,80€	RWKT039	24,90€	411110841	28,80€
250	EXC250 Enduro	13-14	41251402	29,30€	FWKT022	28,90€	41111087	35,50€		41251273	24,80€	RWKT039	24,90€	41111021	58,80€
250	EXC250 Enduro	15-17	41251402	29,30€	FWKT022	28,90€	411111031	30,70€		41251273	24,80€	RWKT039	24,90€	41111021	58,80€
250	EXC250 Racing	02-02			FWKT021	28,90€						RWKT039	24,90€		
250	EXC250 Racing	03-03			FWKT022	28,90€						RWKT039	24,90€		
250	EXC250 Racing	04-15	41251402	29,30€	FWKT022	28,90€	41111087	35,50€		41251273	24,80€	RWKT039	24,90€	411110841	28,80€
250	EXC250 TPI Enduro	18-22	41251402	29,30€	FWKT022	28,90€	411111031	30,70€		41251273	24,80€	RWKT039	24,90€	411110841	28,80€
250	EXC250-F Enduro	07-12	41251402	29,30€	FWKT022	28,90€	41111087	35,50€		41251273	24,80€	RWKT039	24,90€	411110841	28,80€
250	EXC250-F Enduro	13-14	41251402	29,30€	FWKT022	28,90€	41111087	35,50€		41251273	24,80€	RWKT039	24,90€	41111021	58,80€
250	EXC250-F Enduro	15-16	41251402	29,30€	FWKT022	28,90€	411111031	30,70€		41251273	24,80€	RWKT039	24,90€	41111021	58,80€
250	EXC250-F Enduro	17-22	41251402	29,30€	FWKT022	28,90€	411111031	30,70€		41251273	24,80€	RWKT039	24,90€	411110841	28,80€
250	Freeride	13-14	41251406	29,30€						41251273	24,80€	RWKT039	24,90€		
250	Freeride	15-17	41251406	29,30€			411111051	40,30€		41251273	24,80€	RWKT039	24,90€	411110841	28,80€
250	Freeride F	18-20	41251406	29,30€			411111051	40,30€		41251273	24,80€	RWKT039	24,90€	411110841	28,80€
250	SX250	95-99	41251063	17,30€			41111086	35,80€		41251273	24,80€	RWKT039	24,90€	411110841	28,80€
250	SX250	00-02	41251081	27,90€	FWKT020	28,90€	41111089	34,30€		41251273	24,80€	RWKT039	24,90€	411110841	28,80€
250	SX250	03-03	41251402	29,30€	FWKT022	28,90€	41111087	35,50€		41251273	24,80€	RWKT039	24,90€	411110841	28,80€
250	SX250 2T	04-12	41251402	29,30€	FWKT022	28,90€	41111087	35,50€		41251273	24,80€	RWKT039	24,90€	411110841	28,80€
250	SX250 2T	13-14	41251402	29,30€	FWKT022	28,90€	41111087	35,50€		41251273	24,80€	RWKT039	24,90€	41111021	58,80€
250	SX250 2T	15-22	41251402	29,30€	FWKT022	28,90€	411111031	30,70€		41251273	24,80€	RWKT039	24,90€	41111021	58,80€
250	SX250-F	05-12	41251402	29,30€	FWKT022	28,90€	41111087	35,50€		41251273	24,80€	RWKT039	24,90€	411110841	28,80€
250	SX250-F	13-14	41251402	29,30€	FWKT022	28,90€	41111087	35,50€		41251273	24,80€	RWKT039	24,90€	41111021	58,80€







Cyl.	Modèle	Années	ROUE AVANT				ROUE ARRIERE							
			ROULEMENTS ET JOINTS		ROULEMENTS		ENTRETOISES		ROULEMENTS ET JOINTS		ROULEMENTS		ENTRETOISES	
				€T.T.C.		€T.T.C.		€T.T.C.		€T.T.C.		€T.T.C.		€T.T.C.
KTM														
250	SX250-F	15-22	41251402	29,30€	FWKT022	28,90€	41111031	30,70€	41251273	24,80€	RWKT039	24,90€	41111021	58,80€
300	EGS300	94-99	41251061	34,70€			41111085	18,30€	41251273	24,80€	RWKT039	24,90€	411110841	28,80€
300	EXC300 Enduro	94-99	41251061	34,70€			41111085	18,30€	41251273	24,80€	RWKT039	24,90€	411110841	28,80€
300	EXC300 Enduro	00-02	41251080	30,10€	FWKT021	28,90€	41111088	17,60€	41251273	24,80€	RWKT039	24,90€	411110841	28,80€
300	EXC300 Enduro	03-03	41251402	29,30€	FWKT022	28,90€	41111067	53,80€	41251273	24,80€	RWKT039	24,90€	411110841	28,80€
300	EXC300 Enduro	04-12	41251402	29,30€	FWKT022	28,90€	41111087	35,50€	41251273	24,80€	RWKT039	24,90€	411110841	28,80€
300	EXC300 Enduro	13-14	41251402	29,30€	FWKT022	28,90€	41111087	35,50€	41251273	24,80€	RWKT039	24,90€	41111021	58,80€
300	EXC300 Enduro	15-17	41251402	29,30€	FWKT022	28,90€	411111031	30,70€	41251273	24,80€	RWKT039	24,90€	41111021	58,80€
300	EXC300 TPI Enduro	18-22	41251402	29,30€	FWKT022	28,90€	411111031	30,70€	41251273	24,80€	RWKT039	24,90€	411110841	28,80€
350	EXC350-F	12-15	41251402	29,30€	FWKT022	28,90€	41111087	35,50€	41251273	24,80€	RWKT039	24,90€	411110841	28,80€
350	EXC350-F	16-22	41251402	29,30€	FWKT022	28,90€	411111031	30,70€	41251273	24,80€	RWKT039	24,90€	411110841	28,80€
350	Freeride 350	12-17	41251406	29,30€			411111051	40,30€	41251273	24,80€	RWKT039	24,90€	411110841	28,80€
350	LC4 350	14-14	41251061	34,70€					41251283	122,30€				
350	SX350-F	11-12	41251402	29,30€	FWKT022	28,90€	41111087	35,50€	41251273	24,80€	RWKT039	24,90€	411110841	28,80€
350	SX350-F	13-14	41251402	29,30€	FWKT022	28,90€	41111087	35,50€	41251273	24,80€	RWKT039	24,90€	41111021	58,80€
350	SX350-F	15-22	41251402	29,30€	FWKT022	28,90€	411111031	30,70€	41251273	24,80€	RWKT039	24,90€	41111021	58,80€
360	EGS360	96-97	41251061	34,70€			41111085	18,30€	41251273	24,80€	RWKT039	24,90€	411110841	28,80€
360	EXC360	96-97	41251061	34,70€			41111085	18,30€	41251273	24,80€	RWKT039	24,90€	411110841	28,80€
360	SX360	96-97	41251063	17,30€			41111086	35,80€	41251273	24,80€	RWKT039	24,90€	411110841	28,80€
360	SX360	98-98	41251063	17,30€					41251273	24,80€	RWKT039	24,90€		
380	EGS380	98-99	41251061	34,70€			41111085	18,30€	41251273	24,80€	RWKT039	24,90€	411110841	28,80€
380	EXC380	98-99	41251061	34,70€			41111085	18,30€	41251273	24,80€	RWKT039	24,90€	411110841	28,80€
380	EXC380	00-02	41251080	30,10€	FWKT021	28,90€	41111088	17,60€	41251273	24,80€	RWKT039	24,90€	411110841	28,80€
380	SX380	98-99	41251063	17,30€	FWKT026	28,90€	41111086	35,80€	41251273	24,80€	RWKT039	24,90€	411110841	28,80€
380	SX380	00-02	41251081	27,90€	FWKT020	28,90€	41111089	34,30€	41251273	24,80€	RWKT039	24,90€	411110841	28,80€
380	XC380	98-99									RWKT039	24,90€		
400	EGS400 LC4	94-94	41251061	34,70€					41251283	122,30€			411110921	55,60€
400	EGS400 LC4	95-97	41251061	34,70€			41111085	18,30€	41251283	122,30€			411110921	55,60€
400	EXC400	00-02	41251080	30,10€			41111088	17,60€	41251273	24,80€	RWKT039	24,90€	411110841	28,80€
400	EXC400	04-06	41251402	29,30€	FWKT022	28,90€			41251273	24,80€	RWKT039	24,90€		
400	MXC400	01-02	41251080	30,10€	FWKT021	28,90€			41251273	24,80€	RWKT039	24,90€	411110841	28,80€
400	SX400 Enduro	00-02	41251081	27,90€	FWKT020	28,90€	41111089	34,30€	41251273	24,80€	RWKT039	24,90€	411110841	28,80€
400	SX400 Racing	00-02	41251081	27,90€	FWKT020	28,90€	41111089	34,30€	41251273	24,80€	RWKT039	24,90€	411110841	28,80€
450	EXC450-F	03-04	41251402	29,30€	FWKT022	28,90€	41111087	35,50€	41251273	24,80€	RWKT039	24,90€	411110841	28,80€
450	EXC450-F	05-06			FWKT022	28,90€	41111087	35,50€			RWKT039	24,90€	411110841	28,80€
450	EXC450-F	07-07	41251402	29,30€	FWKT022	28,90€	41111087	35,50€	41251273	24,80€	RWKT039	24,90€	411110841	28,80€
450	EXC450-F	08-08	41251402	29,30€	FWKT022	28,90€	41111087	35,50€			RWKT039	24,90€	411110841	28,80€
450	EXC450-F	09-12	41251402	29,30€	FWKT022	28,90€	41111087	35,50€	41251273	24,80€	RWKT039	24,90€	411110841	28,80€
450	EXC450-F	13-14	41251402	29,30€	FWKT022	28,90€	41111087	35,50€	41251273	24,80€	RWKT039	24,90€	41111021	58,80€
450	EXC450-F	15-16	41251402	29,30€	FWKT022	28,90€	411111031	30,70€	41251273	24,80€	RWKT039	24,90€	41111021	58,80€
450	EXC450-F	17-22	41251402	29,30€	FWKT022	28,90€	411111031	30,70€	41251273	24,80€	RWKT039	24,90€	411110841	28,80€
450	EXC450-R	03-08	41251402	29,30€	FWKT022	28,90€			41251273	24,80€	RWKT039	24,90€		
450	EXC450-R	09-11	41251402	29,30€	FWKT022	28,90€	41111087	35,50€	41251273	24,80€	RWKT039	24,90€	411110841	28,80€
450	EXC450-R	12-14			FWKT022	28,90€	41111087	35,50€	41251273	24,80€	RWKT039	24,90€		
450	EXC450-R	15-16			FWKT022	28,90€	411111031	30,70€	41251273	24,80€	RWKT039	24,90€		
450	MXC450	03-05	41251402	29,30€	FWKT022	28,90€	41111087	35,50€	41251273	24,80€	RWKT039	24,90€	411110841	28,80€
450	RFR Rallye Factory Replica	12-14			FWKT022	28,90€					RWKT039	24,90€		
450	SMR450	04-14	41251402	29,30€	FWKT022	28,90€	41111087	35,50€	41251273	24,80€	RWKT039	24,90€	411110841	28,80€
450	SMR450	21-21	41251402	29,30€	FWKT022	28,90€	411111031	30,70€	41251273	24,80€	RWKT039	24,90€	41111021	58,80€
450	SX450 Racing	03-15	41251402	29,30€	FWKT022	28,90€			41251273	24,80€	RWKT039	24,90€		
450	SX450-F	03-06	41251402	29,30€	FWKT022	28,90€			41251273	24,80€	RWKT039	24,90€		
450	SX450-F	07-16	41251402	29,30€	FWKT022	28,90€	41111087	35,50€	41251273	24,80€	RWKT039	24,90€	411110841	28,80€
450	SX450-F	17-22	41251402	29,30€	FWKT022	28,90€	411111031	30,70€	41251273	24,80€	RWKT039	24,90€	41111021	58,80€
450	SXS450-F	07-08	41251402	29,30€	FWKT022	28,90€			41251273	24,80€	RWKT039	24,90€		
450	XC450-F	08-09	41251402	29,30€	FWKT022	28,90€	41111087	35,50€	41251273	24,80€	RWKT039	24,90€	411110841	28,80€
450	XC450-F	10-13	41251402	29,30€	FWKT022	28,90€			41251273	24,80€	FWKT022	28,90€		
450	XC450-W /WR	08-13	41251402	29,30€	FWKT022	28,90€	41111087	35,50€	41251273	24,80€	FWKT022	28,90€	411110841	28,80€
500	EXC500-F	12-15	41251402	29,30€	FWKT022	28,90€	41111087	35,50€	41251273	24,80€	RWKT039	24,90€	411110841	28,80€









Cyl.	Modèle	Années	ROUE AVANT						ROUE ARRIERE					
			ROULEMENTS ET JOINTS		ROULEMENTS		ENTRETOISES		ROULEMENTS ET JOINTS		ROULEMENTS		ENTRETOISES	
				€T.T.C.		€T.T.C.		€T.T.C.		€T.T.C.		€T.T.C.		€T.T.C.
500	EXC500-F	16-22	41251402	29,30€	FWKT022	28,90€	41111031	30,70€	41251273	24,80€	RWKT039	24,90€	41110841	28,80€
505	SX505 F Racing	08-08	41251402	29,30€	FWKT022	28,90€	41111087	35,50€	41251273	24,80€	RWKT039	24,90€		
505	SX505 F Racing	09-11	41251402	29,30€	FWKT022	28,90€			41251273	24,80€	RWKT039	24,90€		
505	XC505-F	09-11	41251402	29,30€	FWKT022	28,90€			41251273	24,80€	RWKT039	24,90€		
520	EXC520 Racing 4T	01-02	41251080	30,10€			41111088	17,60€	41251273	24,80€	RWKT039	24,90€	41110841	28,80€
520	MXC520 2T	01-02	41251080	30,10€					41251273	24,80€	RWKT039	24,90€	41110841	28,80€
520	MXC520 4T	01-02	41251080	30,10€					41251273	24,80€	RWKT039	24,90€	41110841	28,80€
520	SX520 Racing 4T	01-02	41251080	30,10€					41251273	24,80€	RWKT039	24,90€	41110841	28,80€
525	EXC525 Racing 4T	03-03					41111087	35,50€					41110841	28,80€
525	EXC525 Racing 4T	03-07	41251402	29,30€	FWKT022	28,90€	41111087	35,50€	41251273	24,80€	RWKT039	24,90€	41110841	28,80€
525	MXC525 2T	03-03	41251402	29,30€	FWKT022	28,90€	41111087	35,50€	41251273	24,80€	RWKT039	24,90€	41110841	28,80€
525	MXC525 4T	03-06	41251402	29,30€	FWKT022	28,90€	41111087	35,50€	41251273	24,80€	RWKT039	24,90€	41110841	28,80€
525	SX525 Racing 2T	03-03	41251402	29,30€	FWKT022	28,90€	41111087	35,50€	41251273	24,80€	RWKT039	24,90€	41110841	28,80€
525	SX525 Racing 4T	03-08	41251402	29,30€	FWKT022	28,90€	41111087	35,50€	41251273	24,80€	RWKT039	24,90€	41110841	28,80€
530	EXC530	08-11	41251402	29,30€	FWKT022	28,90€	41111087	35,50€	41251273	24,80€	RWKT039	24,90€	41110841	28,80€
550	MXC550	93-93	41251063	17,30€					41251273	24,80€	RWKT039	24,90€		
550	MXC550	94-94	41251063	17,30€					41251273	24,80€	RWKT039	24,90€	41110841	28,80€
550	MXC550	95-96	41251063	17,30€					41251273	24,80€	RWKT039	24,90€		
560	SMR560	06-07	41251402	29,30€	FWKT022	28,90€	41111087	35,50€	41251273	24,80€	RWKT039	24,90€	41110841	28,80€
600	EGS600 LC4 Enduro	91-91	41251063	17,30€										
600	EGS600 LC4 Enduro	92-92	41251061	34,70€										
620	EXC620 LC4	94-95	41251063	17,30€					41251273	24,80€	RWKT039	24,90€	41110841	28,80€
620	EXC620 LC4	96-99	41251061	34,70€					41251283	122,30€			41110841	28,80€
620	SX620 LC4	97-99	41251063	17,30€					41251273	24,80€	RWKT039	24,90€		
690	Enduro 690	08-15	41251402	29,30€	FWKT022	28,90€	41111087	35,50€	41251533	35,50€				
690	Enduro 690 R	09-21	41251402	29,30€	FWKT022	28,90€	41111087	35,50€	41251533	35,50€				
MONTESA														
250	Cota 315R 250	97-00	41251425	29,80€					41251425	29,80€				
250	Cota 4RT 250	05-07	41251425	29,80€					41251425	29,80€				
360	Cota 315R 360	01-04	41251425	29,80€					41251425	29,80€				
Rieju														
250	MR250	22-22	41251364	29,60€	FWKG002	28,90€			41251458	26,90€	RWKG007	38,90€		
300	MR300	21-22	41251364	29,60€	FWKG002	28,90€			41251458	26,90€	RWKG007	38,90€		
300	MR300 Ranger	22-22	41251364	29,60€	FWKG002	28,90€			41251458	26,90€	RWKG007	38,90€		
SHERCO														
50	Enduro 50	03-13	41251143	9,10€					41251135	10,30€				
50	SE 0.5 50	09-16	41251143	9,10€					41251135	10,30€				
80	Sherco 0.8 80	03-08	41251425	29,80€					41251425	29,80€				
80	ST 0.8 80	09-13	41251425	29,80€					41251425	29,80€				
125	SE 125-R	18-22	41251070	20,40€	FWKG001	28,90€			41251556	47,50€	RWKQ011	47,90€		
125	ST 1.25 125	09-17	41251425	29,80€					41251425	29,80€				
125	ST 125	18-22	41251425	29,80€					41251425	29,80€				
125	TY 125 Classic	19-21	41251070	20,40€	FWKG001	28,90€								
125	X-Ride 125	11-14	41251143	9,10€					41251135	10,30€				
250	Enduro 2.5 i 250	08-11	41251070	20,40€	FWKG001	28,90€			41251556	47,50€	RWKQ011	47,90€		
250	SC250	19-19	41251070	20,40€	FWKG001	28,90€			41251556	47,50€	RWKQ011	47,90€		
250	SCF250	19-19	41251070	20,40€	FWKG001	28,90€			41251556	47,50€	RWKQ011	47,90€		
250	SE 2.5i-F 250	09-13	41251070	20,40€	FWKG001	28,90€			41251556	47,50€	RWKQ011	47,90€		
250	SE-R 250	14-22	41251070	20,40€	FWKG001	28,90€			41251556	47,50€	RWKQ011	47,90€		
250	SE-R 250 Factory	14-22	41251070	20,40€	FWKG001	28,90€			41251556	47,50€	RWKQ011	47,90€		
250	SEF-R 2,5 250 4T	14-22	41251070	20,40€	FWKG001	28,90€			41251556	47,50€	RWKQ011	47,90€		
250	SEF-R 2,5 250 4T Factory	14-22	41251070	20,40€	FWKG001	28,90€			41251556	47,50€	RWKQ011	47,90€		
250	Sherco 2.5 250	98-14	41251425	29,80€					41251425	29,80€				
250	ST 2.5 250	09-17	41251425	29,80€					41251425	29,80€				
250	ST 250	18-22	41251425	29,80€					41251425	29,80€				
250	SX 250 2,5i-F	09-11	41251425	29,80€					41251425	29,80€				
290	Sherco 2.9 290	01-15	41251425	29,80€					41251425	29,80€				
290	ST 2.9 290	09-13	41251425	29,80€					41251425	29,80€				
290	X-Ride 290	11-13	41251143	9,10€					41251135	10,30€				







Cyl.	Modèle	Années	ROUE AVANT				ROUE ARRIERE							
			ROULEMENTS ET JOINTS		ROULEMENTS		ENTRETOISES		ROULEMENTS ET JOINTS		ROULEMENTS		ENTRETOISES	
				€T.T.C.		€T.T.C.		€T.T.C.		€T.T.C.		€T.T.C.		€T.T.C.
SHERCO														
290	X-Ride 290	14-19	41251425	29,80€					41251425	29,80€				
300	SC300	19-19	41251070	20,40€	FWKG001	28,90€			41251556	47,50€	RWKQ011	47,90€		
300	SCF300	19-19	41251070	20,40€	FWKG001	28,90€			41251556	47,50€	RWKQ011	47,90€		
300	SE-R 3,0	13-16	41251070	20,40€	FWKG001	28,90€			41251556	47,50€	RWKQ011	47,90€		
300	SE-R 3,0 i	10-12	41251070	20,40€	FWKG001	28,90€			41251556	47,50€	RWKQ011	47,90€		
300	SE-R 300	15-22	41251070	20,40€	FWKG001	28,90€			41251556	47,50€	RWKQ011	47,90€		
300	SE-R 300 Factory	13-22	41251070	20,40€	FWKG001	28,90€			41251556	47,50€	RWKQ011	47,90€		
300	SEF-R 300 4T	14-22	41251070	20,40€	FWKG001	28,90€			41251556	47,50€	RWKQ011	47,90€		
300	SEF-R 300 4T Factory	14-22	41251070	20,40€	FWKG001	28,90€			41251556	47,50€	RWKQ011	47,90€		
300	ST 3,0 Factory	14-14	41251070	20,40€	FWKG001	28,90€			41251556	47,50€	RWKQ011	47,90€		
300	ST 3,0 Factory	15-16	41251425	29,80€					41251425	29,80€				
300	ST 3.0 2T	13-17	41251425	29,80€					41251425	29,80€				
300	ST 3.0R 2T	13-14	41251425	29,80€					41251425	29,80€				
300	ST 300	18-22	41251425	29,80€					41251425	29,80€				
320	Sherco 3.2 320	03-08	41251070	20,40€	FWKG001	28,90€			41251556	47,50€	RWKQ011	47,90€		
320	ST 3.2-F 320	09-13	41251425	29,80€					41251425	29,80€				
450	Enduro 4.5i 450	04-08	41251070	20,40€	FWKG001	28,90€			41251556	47,50€	RWKQ011	47,90€		
450	SCF450	19-19	41251070	20,40€	FWKG001	28,90€			41251556	47,50€	RWKQ011	47,90€		
450	SE 4.5i-F 450	09-13	41251070	20,40€	FWKG001	28,90€			41251556	47,50€	RWKQ011	47,90€		
450	SEF-R 450	17-21	41251070	20,40€	FWKG001	28,90€			41251556	47,50€	RWKQ011	47,90€		
450	SEF-R 450 Factory	16-21	41251070	20,40€	FWKG001	28,90€			41251556	47,50€	RWKQ011	47,90€		
450	SM 4.5i-F 450	09-13	41251070	20,40€	FWKG001	28,90€			41251556	47,50€	RWKQ011	47,90€		
450	Supermotard 4.5i 450	05-08	41251070	20,40€	FWKG001	28,90€			41251556	47,50€	RWKQ011	47,90€		
500	SCF500	19-19	41251070	20,40€	FWKG001	28,90€			41251556	47,50€	RWKQ011	47,90€		
500	SEF-R 500	20-21	41251070	20,40€	FWKG001	28,90€			41251556	47,50€	RWKQ011	47,90€		
500	SEF-R 500 Factory	20-21	41251070	20,40€	FWKG001	28,90€			41251556	47,50€	RWKQ011	47,90€		
510	Enduro 5.1i 510	06-08	41251070	20,40€	FWKG001	28,90€			41251556	47,50€	RWKQ011	47,90€		
510	SE 5.1i-F 510	09-11	41251070	20,40€	FWKG001	28,90€			41251556	47,50€	RWKQ011	47,90€		
510	SM 5.1i-F 510	09-13	41251070	20,40€	FWKG001	28,90€			41251556	47,50€	RWKQ011	47,90€		
510	Supermotard 5.1i 510	07-08	41251070	20,40€	FWKG001	28,90€			41251556	47,50€	RWKQ011	47,90€		
SUZUKI														
50	JR 50	04-07	41251040	13,40€					41251040	13,40€				
50	LT50	84-87	41251045	16,20€					41251364	29,60€				
50	LT50 A Quadmaster	02-05	41251194	29,20€										
65	RM65	03-05	41251181	17,00€	FWKK031	19,90€	41111024	32,50€	41251181	17,00€	FWKK031	19,90€	41111033	16,00€
65	RM65	06-06	41251181	17,00€	FWKK031	19,90€			41251181	17,00€	FWKK031	19,90€		
70	DR-Z 70 L	12-19	41251025	15,80€	FWKY040	19,90€			41251573	22,40€				
80	LT80 Quadspport	89-10	41251194	29,20€										
80	RM80	80-82	41251166	24,20€					41251289	16,50€				
80	RM80	83-85	41251138	14,80€					41251199	12,80€				
80	RM80	86-89	41251138	14,80€					41251160	14,80€	RWKH200	19,90€		
80	RM80	90-01	41251172	11,20€	FWKS040	-			41251168	14,80€	RWKY164	16,90€		
85	RM85 / L	02-22	41251172	11,20€	FWKS040	-			41251168	14,80€	RWKY164	16,90€	41111076	-
110	DRZ110	01-06	41251165	25,30€			41111023	10,15€	41251400	37,70€			41111037	17,40€
110	DRZ110	07-07	41251165 41251439	25,30€ 34,70€			41111023	10,15€	41251400	37,70€			41111037	17,40€
125	DR-Z 125 /L	03-15	41251165 41251439	25,30€ 34,70€					41251517	33,30€			41111038	19,60€
125	DR-Z 125 L	16-22	41251165 41251439	25,30€ 34,70€					41251517	33,30€			41111038	19,60€
125	LT 125 E,H	84-87	41251215	31,40€										
125	RM125	75-76	41251303	14,00€					41251197	20,10€				
125	RM125	77-78	41251167	27,10€					41251197	20,10€				
125	RM125	79-80	41251167	27,10€					41251143	9,10€				
125	RM125	81-86	41251143	9,10€					41251143	9,10€				
125	RM125	87-87	41251135	10,30€	FWKT025	19,90€			41251371	24,20€				
125	RM125	88-88	41251135	10,30€	FWKT025	19,90€			41251263	37,40€				
125	RM125	89-91	41251135	10,30€	FWKT025	19,90€			41251263	37,40€			41111044	23,80€
125	RM125	92-92	41251135	10,30€	FWKT025	19,90€			41251233	26,30€			41111044	23,80€
125	RM125	93-94	41251135	10,30€	FWKT025	19,90€			41251233	26,30€			41111046	72,90€





Cyl.	Modèle	Années	ROUE AVANT						ROUE ARRIERE					
			ROULEMENTS ET JOINTS		ROULEMENTS		ENTRETOISES		ROULEMENTS ET JOINTS		ROULEMENTS		ENTRETOISES	
				€T.T.C.		€T.T.C.		€T.T.C.		€T.T.C.		€T.T.C.		€T.T.C.
125	RM125	95-95	41251135	10,30€	FWKT025	19,90€			41251243	28,80€			41110471	76,90€
125	RM125	96-96	41251079	27,90€			4111053	57,10€	41251243	28,80€			41110481	40,30€
125	RM125	97-99	41251079	27,90€			4111054	37,60€	41251243	28,80€			41110481	40,30€
125	RM125	00-00	41251079	27,90€			4111054	37,60€	41251255	35,80€	RWKS157	28,90€	41110491	77,10€
125	RM125	01-13	41251363	27,80€	FWKS039	28,90€	41110551	61,10€	41251255	35,80€	RWKS157	28,90€	41110491	77,10€
160	LT160E Quadrunner	89-92	41251215	31,40€										
160	LT160F QuadSport	91-04	41251215	31,40€										
250	DR-Z 250	01-10	41251051	12,90€			4111056	22,00€	41251066	25,70€			4111050	49,90€
250	LT-F 250 Ozark	02-04	41251215	31,40€										
250	RM-Z 250	04-06	41251079	27,90€	FWKK029	28,90€	4111029	33,60€	41251406	29,30€	RWKK123	28,90€	41110421	78,40€
250	RM-Z 250	07-21	41251482	33,60€	FWKS047	28,90€	41110581	81,70€	41251250	29,40€	RWKS166	28,90€	41110511	81,10€
250	RM-Z 250	22-22	41251482	33,60€	FWKS047	28,90€			41251250	29,40€	RWKS166	28,90€		
250	RM250	76-76	41251289	16,50€					41251147	15,10€				
250	RM250	77-77	41251289	16,50€					41251105	20,74€				
250	RM250	78-78	41251167	27,10€					41251210	12,40€				
250	RM250	79-80	41251167	27,10€					41251143	9,10€				
250	RM250	81-83	41251143	9,10€					41251143	9,10€				
250	RM250	84-86	41251143	9,10€					41251242	29,20€				
250	RM250	87-87	41251135	10,30€	FWKT025	19,90€			41251263	37,40€				
250	RM250	88-88	41251135	10,30€	FWKT025	19,90€			41251262	18,40€				
250	RM250	89-91	41251135	10,30€	FWKT025	19,90€			41251262	18,40€			4111044	23,80€
250	RM250	92-92	41251135	10,30€	FWKT025	19,90€			41251233	26,30€			4111044	23,80€
250	RM250	93-94	41251135	10,30€	FWKT025	19,90€			41251233	26,30€			4111046	72,90€
250	RM250	95-95	41251135	10,30€	FWKT025	19,90€			41251233	26,30€			41110471	76,90€
250	RM250	96-96	41251079	27,90€			4111053	57,10€	41251243	28,80€			41110481	40,30€
250	RM250	97-99	41251079	27,90€			4111054	37,60€	41251243	28,80€			41110481	40,30€
250	RM250	00-00	41251079	27,90€			4111054	37,60€	41251255	35,80€	RWKS157	28,90€	41110491	77,10€
250	RM250	01-08	41251363	27,80€	FWKS039	28,90€	41110551	61,10€	41251255	35,80€	RWKS157	28,90€	41110491	77,10€
250	RMX250	89-90	41251051	12,90€			4111056	22,00€	41251262	18,40€			4111044	23,80€
250	RMX250	91-01	41251052	29,40€			4111056	22,00€	41251262	18,40€			4111044	23,80€
400	DR-Z 400 /S	00-09	41251753	22,40€			4111057	24,20€	41251117	52,70€			41110481	40,30€
400	DR-Z 400 E	00-07	41251753	22,40€			4111057	24,20€	41251117	52,70€			41110481	40,30€
400	RM400	78-78	41251167	27,10€					41251210	12,40€				
400	RM400	79-80	41251167	27,10€					41251143	9,10€				
450	RM-Z 450	05-22	41251482	33,60€	FWKS047	28,90€	41110581	81,70€	41251250	29,40€	RWKS166	28,90€	41110511	81,10€
450	RMX450 Z	10-15	41251482	33,60€	FWKS047	28,90€	41110581	81,70€	41251250	29,40€	RWKS166	28,90€	41110511	81,10€
500	RM500	83-83	41251143	9,10€					41251198	38,10€				
500	RM500	84-84	41251143	9,10€										
TM														
125	Cross MX125	98-04	41251135	10,30€	FWKT025	19,90€			41251550	46,30€				
125	Cross MX125	05-06	41251549	64,20€					41251548	70,70€				
125	Cross MX125	07-11							41251548	70,70€				
125	Enduro 125	98-04	41251135	10,30€	FWKT025	19,90€								
125	Enduro EN125	05-06	41251549	64,20€					41251548	70,70€				
125	Enduro EN125	07-11							41251548	70,70€				
125	SMR125	09-10							41251548	70,70€				
250	Cross 250 /F	01-04	41251135	10,30€	FWKT025	19,90€			41251550	46,30€				
250	Cross 250 /F	05-06	41251549	64,20€					41251548	70,70€				
250	Cross 250 /F	07-11							41251548	70,70€				
250	Enduro 250 /F	01-04	41251135	10,30€	FWKT025	19,90€			41251550	46,30€				
250	Enduro 250 /F	05-06	41251549	64,20€					41251548	70,70€				
250	Enduro 250 /F	07-11							41251548	70,70€				
300	Cross 300	01-04	41251135	10,30€	FWKT025	19,90€			41251550	46,30€				
300	Cross 300	05-06	41251549	64,20€					41251548	70,70€				
300	Cross 300	07-11							41251548	70,70€				
300	Enduro 300	01-04	41251135	10,30€	FWKT025	19,90€			41251550	46,30€				
300	Enduro 300	05-06	41251549	64,20€					41251548	70,70€				
300	Enduro 300	07-11							41251548	70,70€				
450	Cross 450 F	02-03	41251135	10,30€					41251550	46,30€				

Cyl.	Modèle	Années	ROUE AVANT				ROUE ARRIERE							
			ROULEMENTS ET JOINTS		ROULEMENTS		ENTRETOISES		ROULEMENTS ET JOINTS		ROULEMENTS		ENTRETOISES	
				€T.T.C.		€T.T.C.		€T.T.C.		€T.T.C.		€T.T.C.		€T.T.C.
TM														
450	Cross 450 F	04-04	41251135	10,30€	FWKT025	19,90€			41251550	46,30€				
450	Cross 450 F	05-06	41251549	64,20€					41251548	70,70€				
450	Cross 450 F	07-11							41251548	70,70€				
450	Enduro 450 F	04-04	41251135	10,30€	FWKT025	19,90€			41251550	46,30€				
450	Enduro 450 F	05-06	41251549	64,20€					41251548	70,70€				
450	Enduro 450 F	07-11							41251548	70,70€				
450	SMR450 F	09-09							41251548	70,70€				
450	SMX450 F	05-05							41251550	46,30€				
450	SMX450 F	06-06	41251549	64,20€					41251550	46,30€				
450	SMX450 F	07-07							41251550	46,30€				
530	Cross 530 F	02-04	41251135	10,30€	FWKT025	19,90€			41251550	46,30€				
530	Cross 530 F	05-06	41251549	64,20€					41251548	70,70€				
530	Cross 530 F	07-11							41251548	70,70€				
530	Enduro 530 F	02-04	41251135	10,30€	FWKT025	19,90€			41251550	46,30€				
530	Enduro 530 F	05-06	41251549	64,20€					41251548	70,70€				
530	Enduro 530 F	07-11							41251548	70,70€				
530	SMR530 F	08-09							41251548	70,70€				
660	SMX660 F	06-06	41251549	64,20€					41251550	46,30€				
660	SMX660 F	07-07							41251550	46,30€				
660	SMX660 F	08-09							41251548	70,70€				
YAMAHA														
50	PW50	83-21	41251159	20,50€					41251505	29,20€				
50	TT-R50 E	18-22	41251025	15,80€	FWKY040	19,90€			41251025	15,80€				
60	YZ60	85-85	41251161	20,90€					41251292	33,70€				
65	YZ 65	18-22	41251736	21,00€					41251168	14,80€	RWKY164	16,90€	41111076	-
80	PW80	83-13	41251161	20,90€					41251095	47,30€				
80	YFM80 Badger	95-01	41251052	29,40€										
80	YFM80 Raptor	02-07	41251052	29,40€										
80	YZ80	74-77	41251009	15,80€					41251292	33,70€				
80	YZ80	78-79	41251009	15,80€					41251296	30,00€				
80	YZ80	80-81	41251009	15,80€					41251292	33,70€				
80	YZ80	82-83	41251009	15,80€					41251319	32,40€				
80	YZ80	84-84	41251009	15,80€					41251185	30,90€				
80	YZ80	85-92	41251009	15,80€					41251185	30,90€				
80	YZ80	93-01	41251025	15,80€	FWKY040	19,90€	41111061	-	41251168	14,80€	RWKY164	16,90€	41111076	-
85	YZ85 /LW	02-18	41251025	15,80€	FWKY040	19,90€	41111061	-	41251168	14,80€	RWKY164	16,90€	41111076	-
85	YZ85 /LW	19-22	41251736	21,00€					41251168	14,80€	RWKY164	16,90€	41111076	-
90	TT90 R	00-03	41251161	20,90€					41251095	47,30€				
110	TT-R110 E	08-22	41251161	20,90€					41251589	26,60€				
125	TT125 R (17"/14")	00-04	41251292	33,70€					41251292	33,70€			41111077	-
125	TT125 R (19"/16")	00-22	41251041	14,77€					41251292	33,70€			41111077	-
125	YFM125 Grizzly	04-13	41251052	29,40€										
125	YZ125	76-79	41251038	11,60€					41251201	33,90€				
125	YZ125	80-81	41251038	11,60€					41251200	25,50€				
125	YZ125	82-82	41251038	11,60€					41251228	19,10€				
125	YZ125	83-84	41251444	11,80€					41251228	19,10€				
125	YZ125	85-85	41251444	11,80€			41111064	15,50€	41251228	19,10€				
125	YZ125	86-86	41251444	11,80€			41111065	29,90€	41251271	24,40€			411110781	45,10€
125	YZ125	87-87	41251444	11,80€			41111066	14,66€	41251271	24,40€			411110781	45,10€
125	YZ125	88-88	41251444	11,80€			41111066	14,66€	41251444	11,80€			411110791	40,70€
125	YZ125	89-89	41251444	11,80€			41111066	14,66€	41251444	11,80€				
125	YZ125	90-90	41251444	11,80€			41111066	14,66€	41251444	11,80€			411110931	38,36€
125	YZ125	91-91	41251444	11,80€			41111066	14,66€	41251444	11,80€			411110791	40,70€
125	YZ125	92-95	41251054	15,70€			41111067	53,80€	41251271	24,40€			411110791	40,70€
125	YZ125	96-97	41251090	27,80€			41111067	53,80€	41251271	24,40€			411110791	40,70€
125	YZ125	98-98	41251092	27,50€	FWKY032	28,90€	41111101	25,14€	41251271	24,40€			411110791	40,70€
125	YZ125	99-01	41251092	27,50€	FWKY032	28,90€	41111069	73,10€	41251252	30,70€	RWKY146	28,90€	411110801	75,20€
125	YZ125	02-07	41251092	27,50€	FWKY032	28,90€	41111070	46,80€	41251252	30,70€	RWKY146	28,90€	411110811	40,70€





Cyl.	Modèle	Années	ROUE AVANT						ROUE ARRIERE					
			ROULEMENTS ET JOINTS		ROULEMENTS		ENTRETOISES		ROULEMENTS ET JOINTS		ROULEMENTS		ENTRETOISES	
				€T.T.C.		€T.T.C.		€T.T.C.		€T.T.C.		€T.T.C.		€T.T.C.
125	YZ125	08-22	41251092	27,50€	FWKY032	28,90€	41111100	24,60€	41251252	30,70€	RWKY146	28,90€	411110811	40,70€
200	WR200 R	91-97	41251444	11,80€					41251271	24,40€				
230	TT230R	05-16	41251444	11,80€					41251201	33,90€				
250	TT250 R	99-07	41251059	12,30€					41251021	56,50€				
250	WR250	91-91	41251444	11,80€			41111066	14,66€	41251271	24,40€			411110791	40,70€
250	WR250	92-97	41251054	15,70€			41111067	53,80€	41251271	24,40€			411110791	40,70€
250	WR250 F	01-01	41251632	27,60€	FWKY032	28,90€	41111072	48,00€	41251252	30,70€	RWKY146	28,90€	411110801	75,20€
250	WR250 F	02-03	41251632	27,60€	FWKY032	28,90€	41111073	11,00€	41251252	30,70€	RWKY146	28,90€	411110811	40,70€
250	WR250 F	04-04	41251632	27,60€	FWKY032	28,90€	41111072	48,00€	41251252	30,70€	RWKY171	28,90€	411110801	75,20€
250	WR250 F	05-14	41251632	27,60€	FWKY032	28,90€	41111074	30,40€	41251252	30,70€	RWKY171	28,90€	411110811	40,70€
250	WR250 F	15-19	41251632	27,60€	FWKY032	28,90€	41111073	11,00€	41251252	30,70€	RWKY171	28,90€	411110811	40,70€
250	WR250 F	20-22	41251482	33,60€	FWKS047	28,90€	41111041	43,40€	41251252	30,70€	RWKY171	28,90€	411110811	40,70€
250	WR250 Z	91-91	41251444	11,80€			41111066	14,66€	41251271	24,40€			411110791	40,70€
250	WR250 Z	92-97	41251054	15,70€			41111067	53,80€	41251271	24,40€			411110791	40,70€
250	YZ250	80-80	41251038	11,60€					41251228	19,10€				
250	YZ250	81-81	41251038	11,60€					41251267	27,40€				
250	YZ250	82-82	41251038	11,60€					41251271	24,40€				
250	YZ250	83-84	41251444	11,80€					41251267	27,40€				
250	YZ250	85-85	41251444	11,80€			41111075	16,20€	41251267	27,40€			411110781	45,10€
250	YZ250	86-87	41251444	11,80€			41111066	14,66€	41251267	27,40€			411110781	45,10€
250	YZ250	88-88	41251444	11,80€			41111066	14,66€	41251271	24,40€			411110791	40,70€
250	YZ250	89-89	41251444	11,80€			41111066	14,66€	41251271	24,40€				
250	YZ250	90-90	41251444	11,80€			41111066	14,66€	41251271	24,40€			411110931	38,36€
250	YZ250	91-91	41251444	11,80€			41111066	14,66€	41251271	24,40€			411110791	40,70€
250	YZ250	92-95	41251054	15,70€			41111067	53,80€	41251271	24,40€			411110791	40,70€
250	YZ250	96-97	41251090	27,80€					41251271	24,40€			411110791	40,70€
250	YZ250	98-98	41251092	27,50€	FWKY032	28,90€	41111101	25,14€	41251271	24,40€			411110791	40,70€
250	YZ250	99-01	41251092	27,50€	FWKY032	28,90€	41111069	73,10€	41251252	30,70€	RWKY146	28,90€	411110801	75,20€
250	YZ250	02-07	41251092	27,50€	FWKY032	28,90€	41111070	46,80€	41251252	30,70€	RWKY146	28,90€	411110811	40,70€
250	YZ250	08-22	41251092	27,50€	FWKY032	28,90€	41111100	24,60€	41251252	30,70€	RWKY146	28,90€	411110811	40,70€
250	YZ250 F	01-01	41251092	27,50€	FWKY032	28,90€	41111069	73,10€	41251252	30,70€	RWKY146	28,90€	411110801	75,20€
250	YZ250 F	02-06	41251092	27,50€	FWKY032	28,90€	41111070	46,80€	41251252	30,70€	RWKY146	28,90€	411110811	40,70€
250	YZ250 F	07-08	41251092	27,50€	FWKY032	28,90€	41111100	24,60€	41251252	30,70€	RWKY146	28,90€	411110811	40,70€
250	YZ250 F	09-13	41251092	27,50€	FWKY032	28,90€	41111100	24,60€	41251406	29,30€	RWKY148	28,90€	411110991	76,40€
250	YZ250 F	14-18	41251482	33,60€	FWKS047	28,90€	41111041	43,40€	41251406	29,30€	RWKY148	28,90€	411110991	76,40€
250	YZ250 F	19-22	41251482	33,60€	FWKS047	28,90€	41111107	25,90€	41251406	29,30€	RWKY148	28,90€	411110991	76,40€
250	YZ250 X	16-19	41251092	27,50€	FWKY032	28,90€	41111100	24,60€	41251252	30,70€	RWKY146	28,90€	411110811	40,70€
350	TT350	86-97	41251444	11,80€					41251267	27,40€				
400	WR400 F	98-98	41251632	27,60€	FWKY032	28,90€	41111072	48,00€	41251271	24,40€			411110791	40,70€
400	WR400 F	99-00	41251632	27,60€	FWKY032	28,90€	41111072	48,00€	41251252	30,70€	RWKY146	28,90€	411110791	40,70€
400	YZ400 F	98-99	41251092	27,50€	FWKY032	28,90€	41111069	73,10€	41251271	24,40€			411110791	40,70€
426	WR426 F	01-01	41251632	27,60€	FWKY032	28,90€	41111072	48,00€	41251252	30,70€	RWKY146	28,90€	411110801	75,20€
426	WR426 F	02-02	41251632	27,60€	FWKY032	28,90€	41111073	11,00€	41251252	30,70€	RWKY146	28,90€	411110811	40,70€
426	YZ426 F	00-01	41251092	27,50€	FWKY032	28,90€	41111069	73,10€	41251252	30,70€	RWKY146	28,90€	411110801	75,20€
426	YZ426 F	02-02	41251092	27,50€	FWKY032	28,90€	41111070	46,80€	41251252	30,70€	RWKY146	28,90€	411110811	40,70€
450	WR450 F	03-03	41251632	27,60€	FWKY032	28,90€	41111073	11,00€	41251252	30,70€	RWKY146	28,90€	411110811	40,70€
450	WR450 F	04-04	41251632	27,60€	FWKY032	28,90€	41111073	11,00€	41251232	48,70€	RWKY171	28,90€	411110811	40,70€
450	WR450 F	05-18	41251632	27,60€	FWKY032	28,90€	41111074	30,40€	41251252	30,70€	RWKY171	28,90€	411110811	40,70€
450	WR450 F	19-19	41251632	27,60€	FWKY032	28,90€	41111041	43,40€	41251252	30,70€	RWKY171	28,90€	411110811	40,70€
450	WR450 F	20-22	41251482	33,60€	FWKS047	28,90€	41111041	43,40€	41251252	30,70€	RWKY171	28,90€	411110811	40,70€
450	YZ450 F	03-07	41251092	27,50€	FWKY032	28,90€	41111070	46,80€	41251252	30,70€	RWKY146	28,90€	411110811	40,70€
450	YZ450 F	08-08	41251092	27,50€	FWKY032	28,90€	41111100	24,60€	41251252	30,70€	RWKY146	28,90€	411110811	40,70€
450	YZ450 F	09-13	41251092	27,50€	FWKY032	28,90€	41111100	24,60€	41251406	29,30€	RWKY148	28,90€	411110991	76,40€
450	YZ450 F	14-18	41251482	33,60€	FWKS047	28,90€	41111041	43,40€	41251406	29,30€	RWKY148	28,90€	411110991	76,40€
450	YZ450 F	19-22	41251482	33,60€	FWKS047	28,90€	41111107	25,90€	41251406	29,30€	RWKY148	28,90€		

ROULEMENTS COLONNE DE DIRECTION



Cyl	Modèle	Année	 € T.T.C.	 € T.T.C.
APRILIA				
280	Climber R(trial)	92-92	41221047 32,60€	SSKT068 28,90€
450	RXV450	06-14	41221067 91,60€	
450	SXV450	06-14	41221067 91,60€	
550	RXV550	06-14	41221067 91,60€	
550	SXV550	06-14	41221067 91,60€	
BETA				
125	Evo 125 (Trial)	12-22	41221047 32,60€	SSKT068 28,90€
125	RR125 Enduro	18-22	41221026 36,60€	SSKT067 42,90€
200	EVO (Tial)	12-20	41221047 32,60€	SSKT068 28,90€
200	RR200 Enduro	19-22	41221026 36,60€	SSKT067 42,90€
250	EVO (Trial)	12-22	41221047 32,60€	SSKT068 28,90€
250	EVO (Trial) 4T	12-19	41221047 32,60€	SSKT068 28,90€
250	RR250 Enduro 2T	13-22	41221026 36,60€	SSKT067 42,90€
250	XTrainer	18-22	41221026 36,60€	SSKT067 42,90€
300	300RR Enduro	13-17	41221026 36,60€	SSKT067 42,90€
300	300RR Enduro 2T	13-22	41221026 36,60€	SSKT067 42,90€
300	EVO (Trial)	09-22	41221047 32,60€	SSKT068 28,90€
300	EVO (Trial) 4T	12-22	41221047 32,60€	SSKT068 28,90€
300	XTrainer	18-22	41221026 36,60€	SSKT067 42,90€
350	350RR Enduro	12-22	41221026 36,60€	SSKT067 42,90€
390	RR390 Enduro	14-22	41221026 36,60€	SSKT067 42,90€
400	RR400 Enduro	05-15	41221026 36,60€	SSKT067 42,90€
430	RR430 Enduro	13-22	41221026 36,60€	SSKT067 42,90€
450	RR450 Enduro	05-15	41221026 36,60€	SSKT067 42,90€
480	RR480 Enduro	13-22	41221026 36,60€	SSKT067 42,90€
498	RR498 Enduro	12-15	41221026 36,60€	SSKT067 42,90€
520	RR520 Enduro	13-15	41221026 36,60€	SSKT067 42,90€
525	RR525 Enduro	05-12	41221026 36,60€	SSKT067 42,90€
BMW				
450	G450 X	08-10	41221068 100,70€	
FANTIC				
125	XE 125	21-22	41221001 44,50€	SSKY319 42,90€
125	XX 125	21-22	41221001 44,50€	SSKY319 42,90€
250	XEF 250	21-22	41221001 44,50€	SSKY319 42,90€
250	XX 250	22-22	41221001 44,50€	SSKY319 42,90€
250	XXF 250	22-22	41221001 44,50€	SSKY319 42,90€
450	XEF 450	22-22	41221001 44,50€	SSKY319 42,90€
450	XXF 450	22-22	41221001 44,50€	SSKY319 42,90€
GAS GAS				
50	MC50	21-22	41221047 32,60€	SSKT068 28,90€
65	MC65	21-22	41221047 32,60€	SSKT068 28,90€
85	MC85	21-22	41221047 32,60€	SSKT068 28,90€
125	EC125	01-05	41221044 27,20€	SSKG015 42,90€
125	EC125	06-14	41221056 44,40€	
125	MC125	01-05	41221044 27,20€	SSKG015 42,90€
125	MC125	06-09	41221056 44,40€	
125	MC125	21-22	41221026 36,60€	SSKT067 42,90€
125	Pampera 125	02-04	41221047 32,60€	SSKT068 28,90€
125	SM125	03-06	41221044 27,20€	SSKG015 42,90€
125	SM125	07-09	41221056 44,40€	
125	TXT125	02-03	41221047 32,60€	SSKT068 28,90€
125	TXT125 Pro	04-17	41221047 32,60€	SSKT068 28,90€
125	TXT125 Racing	18-22	41221047 32,60€	SSKT068 28,90€
200	EC200	99-05	41221044 27,20€	SSKG015 42,90€
200	EC200	06-20	41221056 44,40€	
200	EC200 Ranger	19-20	41221056 44,40€	
200	TXT200	02-13	41221047 32,60€	SSKT068 28,90€
250	EC250	96-05	41221044 27,20€	SSKG015 42,90€
250	EC250	06-20	41221056 44,40€	
250	EC250	21-22	41221026 36,60€	SSKT067 42,90€
250	EC250F	21-22	41221026 36,60€	SSKT067 42,90€
250	MC250	99-05	41221044 27,20€	SSKG015 42,90€
250	MC250	06-09	41221056 44,40€	
250	MC250	22-22	41221026 36,60€	SSKT067 42,90€

ROULEMENTS COLONNE DE DIRECTION



Cyl	Modèle	Année	 € T.T.C.	 € T.T.C.
250	MC250F	21-22	41221026 36,60€	SSKT067 42,90€
250	Pampera 250	02-04	41221047 32,60€	SSKT068 28,90€
250	TXT250	02-22	41221047 32,60€	SSKT068 28,90€
280	TXT280	02-22	41221047 32,60€	SSKT068 28,90€
300	EC300	99-05	41221044 27,20€	SSKG015 42,90€
300	EC300	06-20	41221056 44,40€	
300	EC300	21-22	41221026 36,60€	SSKT067 42,90€
300	EC300 Ranger	19-20	41221056 44,40€	
300	TXT300	04-06	41221047 32,60€	SSKT068 28,90€
300	TXT300 Pro	07-22	41221047 32,60€	SSKT068 28,90€
350	EC350F	21-22	41221026 36,60€	SSKT067 42,90€
350	MC350F	22-22	41221026 36,60€	SSKT067 42,90€
450	EC450 FSE	03-05	41221044 27,20€	SSKG015 42,90€
450	EC450 FSE	06-06	41221056 44,40€	
450	EC450 FSR	07-09	41221056 44,40€	
450	MC450F	21-22	41221026 36,60€	SSKT067 42,90€
HONDA				
50	CRF50	04-22	41221002 47,90€	
50	XR50	00-03	41221002 47,90€	
70	CRF70	04-13	41221002 47,90€	
70	XR70 R	95-03	41221002 47,90€	
80	CR80 R	80-82	41221002 47,90€	
80	CR80 R (17"/14")	87-02	41221021 41,30€	SSKH399 42,90€
80	CRF80	04-09	41221002 47,90€	
80	XR80	79-90	41221002 47,90€	
80	XRR80	85-91	41221002 47,90€	
85	CR85	03-08	41221021 41,30€	SSKH399 42,90€
100	CRF100	04-13	41221002 47,90€	
100	XR100	81-85	41221002 47,90€	
100	XRR100	85-04	41221002 47,90€	
110	CRF 110	13-21	41221002 47,90€	
125	CR125 R	82-89	41221021 41,30€	SSKH399 42,90€
125	CR125 R	90-92	41221018 95,90€	
125	CR125 R	93-94	41221010 55,60€	
125	CR125 R	95-97	41221030 48,40€	
125	CR125 R	98-07	41221010 55,60€	
125	CRF125 F	14-21	41221029 50,10€	
150	CRF150 F	03-14	41221021 41,30€	SSKH399 42,90€
150	CRF150 R	07-15	41221021 41,30€	SSKH399 42,90€
200	TLR D,E,F 200	83-85	41221029 50,10€	
200	TLR G,H 200	86-87	41221029 50,10€	
230	CRF230 F	03-14	41221021 41,30€	SSKH399 42,90€
250	CR250 R	88-89	41221021 41,30€	SSKH399 42,90€
250	CR250 R	90-91	41221018 95,90€	
250	CR250 R	92-94	41221010 55,60€	
250	CR250 R	95-96	41221030 48,40€	
250	CR250 R	97-08	41221010 55,60€	
250	CRF250 R	04-09	41221010 55,60€	
250	CRF250 R	10-13	41221059 54,80€	
250	CRF250 R	14-17	41221065 51,90€	
250	CRF250 R	18-22	41221010 55,60€	
250	CRF250 RX	20-22	41221010 55,60€	
250	CRF250 X	04-15	41221010 55,60€	
300	CRF300 RX	21-22	41221010 55,60€	
400	CRF400 RX	21-22	41221010 55,60€	
400	XR400 R	96-06	41221021 41,30€	SSKH399 42,90€
400	XR400 Supermotard	96-06	41221021 41,30€	SSKH399 42,90€
450	CRF450 R	02-08	41221010 55,60€	
450	CRF450 R	09-12	41221059 54,80€	
450	CRF450 R	13-16	41221065 51,90€	
450	CRF450 R	17-22	41221010 55,60€	
450	CRF450 RX	17-22	41221010 55,60€	
450	CRF450 X	05-20	41221010 55,60€	
480	CR480 R	82-83	41221021 41,30€	SSKH399 42,90€
500	CR500 R	84-89	41221021 41,30€	SSKH399 42,90€





ROUEMENTS COLONNE DE DIRECTION

Cyl	Modèle	Année	 € T.T.C.	 € T.T.C.
500	CR500 R	90-02	41221018 95,90€	
500	XR500 R	81-86	41221021 41,30€	SSKH399 42,90€
500	XR500 S	79-80	41221021 41,30€	SSKH399 42,90€
600	XR600 R	85-90	41221021 41,30€	SSKH399 42,90€
600	XR600 R [FR]	91-00	41221021 41,30€	SSKH399 42,90€
650	XR650 L [US]	93-13	41221021 41,30€	SSKH399 42,90€
650	XR650 R	00-07	41221018 95,90€	
HUSABERG				
250	FE250 4T	13-14	41221026 36,60€	SSKT067 42,90€
250	TE250 2T	11-14	41221026 36,60€	SSKT067 42,90€
300	TE300 2T	13-14	41221026 36,60€	SSKT067 42,90€
350	FE350 /E	96-99	41221026 36,60€	SSKT067 42,90€
350	FE350 4T	13-14	41221026 36,60€	SSKT067 42,90€
350	TE350	14-14	41221026 36,60€	SSKT067 42,90€
390	FE390 Enduro	10-12	41221026 36,60€	SSKT067 42,90€
450	FC450	04-05	41221032 28,10€	
450	FS450 E /C	03-08	41221032 28,10€	
570	FE570 Enduro	09-12	41221026 36,60€	SSKT067 42,90€
650	FE650 E	04-08	41221032 28,10€	
650	FS650 C /E	04-08	41221032 28,10€	
HUSQVARNA				
50	TC 50	17-22	41221047 32,60€	SSKT068 28,90€
50	TC 50 Mini	19-22	41221047 32,60€	SSKT068 28,90€
65	CR 65	12-14	41221047 32,60€	SSKT068 28,90€
65	TC 65	17-22	41221047 32,60€	SSKT068 28,90€
85	TC 85 14/17	16-22	41221047 32,60€	SSKT068 28,90€
85	TC 85 16/19	14-22	41221047 32,60€	SSKT068 28,90€
85	TC85 14/17 Zoll	14-15	41221047 32,60€	SSKT068 28,90€
125	CR125	92-98	41221032 28,10€	
125	CR125	99-13	41221061 78,50€	
125	TC125 2T	13-22	41221026 36,60€	SSKT067 42,90€
125	TE125 2T	13-16	41221026 36,60€	SSKT067 42,90€
125	TX125 2T	17-19	41221026 36,60€	SSKT067 42,90€
125	WR125	98-07	41221032 28,10€	
125	WR125	08-13	41221061 78,50€	
125	WRE125	94-95	41221032 28,10€	
150	TE150i	20-22	41221026 36,60€	SSKT067 42,90€
250	CR250	92-95	41221032 28,10€	
250	CR250	99-05	41221061 78,50€	
250	FC 250	14-22	41221026 36,60€	SSKT067 42,90€
250	FE250	14-22	41221026 36,60€	SSKT067 42,90€
250	TC250	02-13	41221061 78,50€	
250	TC250	14-22	41221026 36,60€	SSKT067 42,90€
250	TE250	02-07	41221032 28,10€	
250	TE250	08-13	41221061 78,50€	
250	TE250	14-17	41221026 36,60€	SSKT067 42,90€
250	TE250i	18-22	41221026 36,60€	SSKT067 42,90€
250	WR250	92-07	41221032 28,10€	
250	WR250	08-13	41221061 78,50€	
300	TE300	14-17	41221026 36,60€	SSKT067 42,90€
300	TE300i	18-22	41221026 36,60€	SSKT067 42,90€
300	WR300	09-13	41221061 78,50€	
310	TE310	08-13	41221061 78,50€	
350	FC 350	14-22	41221026 36,60€	SSKT067 42,90€
350	FE 350	14-22	41221026 36,60€	SSKT067 42,90€
350	TE350	95-99	41221032 28,10€	
360	WR360	92-02	41221032 28,10€	
400	TE400	98-02	41221032 28,10€	
410	TE410	96-13	41221032 28,10€	
450	FC 450	14-22	41221026 36,60€	SSKT067 42,90€
450	FE 450	14-22	41221026 36,60€	SSKT067 42,90€
450	FS 450	15-22	41221026 36,60€	SSKT067 42,90€
450	TC450	02-14	41221061 78,50€	
450	TE450	03-07	41221032 28,10€	
450	TE450	08-13	41221061 78,50€	

ROUEMENTS COLONNE DE DIRECTION

Cyl	Modèle	Année	 € T.T.C.	 € T.T.C.
501	FE 501	14-22	41221026 36,60€	SSKT067 42,90€
510	TE510	88-07	41221032 28,10€	
510	TE510	08-13	41221061 78,50€	
510	TE510 Centennial	04-07	41221032 28,10€	
570	TC570	01-02	41221061 78,50€	
570	TE570	01-02	41221032 28,10€	
610	TC610	98-98	41221032 28,10€	
610	TC610	99-00	41221061 78,50€	
610	TE610	98-07	41221032 28,10€	
610	TE610	08-09	41221061 78,50€	
610	TE610 E	97-07	41221032 28,10€	
610	TE610 E	08-13	41221061 78,50€	
610	TE610 i.e.	08-10	41221061 78,50€	
630	TE630	10-12	41221061 78,50€	
693	Enduro 701	16-22	41221026 36,60€	SSKT067 42,90€
KAWASAKI				
60	KX60	83-99	41221040 52,00€	
65	KX65	00-22	41221022 36,60€	SSKK216 38,90€
80	KX80	89-00	41221022 36,60€	SSKK216 38,90€
85	KX85	01-22	41221022 36,60€	SSKK216 38,90€
110	KLX110	02-09	41221040 52,00€	
110	KLX110	10-21	41221063 97,80€	
125	KX125	82-91	41221004 39,50€	SSKK211 42,90€
125	KX125	92-08	41221023 39,90€	SSKK210 42,90€
200	KDX200	92-06	41221004 39,50€	SSKK211 42,90€
250	KLX250 R	93-98	41221004 39,50€	SSKK211 42,90€
250	KLX250 S /SF	09-17	41221004 39,50€	SSKK211 42,90€
250	KSF Mojave	87-87	41221004 39,50€	SSKK211 42,90€
250	KX250	82-90	41221004 39,50€	SSKK211 42,90€
250	KX250	91-08	41221023 39,90€	SSKK210 42,90€
250	KX250 F	04-18	41221023 39,90€	SSKK210 42,90€
250	KX250 F - KX	19-22	41221023 39,90€	SSKK210 42,90€
250	KX250X Enduro (KL)	22-22	41221023 39,90€	SSKK210 42,90€
300	KLX300 R	97-07	41221004 39,50€	SSKK211 42,90€
450	KLX450 R	05-15	41221023 39,90€	SSKK210 42,90€
450	KX450 F	06-18	41221023 39,90€	SSKK210 42,90€
450	KX450 F - KX	19-22	41221023 39,90€	SSKK210 42,90€
450	KX450 X Enduro (KL)	22-22	41221023 39,90€	SSKK210 42,90€
500	KX500	84-04	41221004 39,50€	SSKK211 42,90€
650	KLX650 C	93-95	41221004 39,50€	SSKK211 42,90€
650	KLX650 R	93-01	41221004 39,50€	SSKK211 42,90€
800	TERYX KRF-KRT	14-14	41221009 41,30€	SSKK218 42,90€
KTM				
0	SX-E	19-22	41221047 32,60€	SSKT068 28,90€
50	SX50	06-22	41221047 32,60€	SSKT068 28,90€
50	SX50 Junior	06-15	41221047 32,60€	SSKT068 28,90€
50	SX50 Mini	19-22	41221047 32,60€	SSKT068 28,90€
50	SX50 Pro Junior LC	02-06	41221047 32,60€	SSKT068 28,90€
50	SX50 Senior Adventure	03-07	41221047 32,60€	SSKT068 28,90€
60	SX60	98-01	41221047 32,60€	SSKT068 28,90€
65	SX65	00-22	41221047 32,60€	SSKT068 28,90€
85	SX85 (17"/14")	03-22	41221047 32,60€	SSKT068 28,90€
85	SX85 (19"/16")	03-22	41221047 32,60€	SSKT068 28,90€
125	EXC125 Enduro	95-18	41221026 36,60€	SSKT067 42,90€
125	EXE125 Enduro	00-01	41221026 36,60€	SSKT067 42,90€
125	MX125	93-94	41221026 36,60€	SSKT067 42,90€
125	SX125	93-22	41221026 36,60€	SSKT067 42,90€
125	XC125 W Enduro	19-19	41221026 36,60€	SSKT067 42,90€
150	EXC150 TPI Enduro	20-22	41221026 36,60€	SSKT067 42,90€
150	SX144	07-08	41221026 36,60€	SSKT067 42,90€
150	SX150	09-22	41221026 36,60€	SSKT067 42,90€
200	EXC200 Enduro	98-16	41221026 36,60€	SSKT067 42,90€
200	SX200	00-06	41221026 36,60€	SSKT067 42,90€
250	EXC250 Enduro	97-17	41221026 36,60€	SSKT067 42,90€
250	EXC250 Racing	02-15	41221026 36,60€	SSKT067 42,90€

ROULEMENTS COLONNE DE DIRECTION



Cyl	Modèle	Année	 € T.T.C.	 € T.T.C.
KTM				
250	EXC250 TPI Enduro	18-22	41221026 36,60€	SSKT067 42,90€
250	EXC250-F Enduro	07-22	41221026 36,60€	SSKT067 42,90€
250	Freeride	13-17	41221026 36,60€	SSKT067 42,90€
250	Freeride F	18-20	41221026 36,60€	SSKT067 42,90€
250	SX250	95-03	41221026 36,60€	SSKT067 42,90€
250	SX250 2T	04-22	41221026 36,60€	SSKT067 42,90€
250	SX250-F	05-22	41221026 36,60€	SSKT067 42,90€
300	EXC300 Enduro	94-17	41221026 36,60€	SSKT067 42,90€
300	EXC300 TPI Enduro	18-22	41221026 36,60€	SSKT067 42,90€
300	SX300	93-95	41221026 36,60€	SSKT067 42,90€
350	EXC350-F	12-22	41221026 36,60€	SSKT067 42,90€
350	Freeride 350	12-17	41221026 36,60€	SSKT067 42,90€
350	SX350-F	11-22	41221026 36,60€	SSKT067 42,90€
360	EGS360	96-97	41221026 36,60€	SSKT067 42,90€
360	EXC360	96-97	41221026 36,60€	SSKT067 42,90€
360	SX360	96-98	41221026 36,60€	SSKT067 42,90€
380	SX380	98-02	41221026 36,60€	SSKT067 42,90€
400	EXC400	00-14	41221026 36,60€	SSKT067 42,90€
400	SX400 Enduro	00-02	41221026 36,60€	SSKT067 42,90€
400	SX400 Racing	00-02	41221026 36,60€	SSKT067 42,90€
400	SX400 Racing (05/2002>)	02-02	41221026 36,60€	SSKT067 42,90€
450	EXC450-F	03-22	41221026 36,60€	SSKT067 42,90€
450	EXC450-R	02-16	41221026 36,60€	SSKT067 42,90€
450	SMR450	04-14		SSKT067 42,90€
450	SMR450	21-21	41221026 36,60€	SSKT067 42,90€
450	SX450 Racing	03-15	41221026 36,60€	SSKT067 42,90€
450	SX450-F	03-22	41221026 36,60€	SSKT067 42,90€
500	EXC500-F	12-22	41221026 36,60€	SSKT067 42,90€
505	SX505	09-13	41221026 36,60€	SSKT067 42,90€
505	SX505 F Racing	07-11	41221026 36,60€	SSKT067 42,90€
505	SX505 F Racing (US)	07-11	41221026 36,60€	SSKT067 42,90€
520	EXC520 Racing	99-99	41221026 36,60€	SSKT067 42,90€
520	EXC520 Racing 4T	01-02	41221026 36,60€	SSKT067 42,90€
525	EXC525 Racing 4T	03-07	41221026 36,60€	SSKT067 42,90€
525	MXC525 2T	03-03	41221026 36,60€	SSKT067 42,90€
525	MXC525 4T	03-06	41221026 36,60€	SSKT067 42,90€
620	EXC620 LC4	94-99	41221026 36,60€	SSKT067 42,90€
620	SX620 LC4	97-99	41221026 36,60€	SSKT067 42,90€
690	Enduro 690	08-15	41221026 36,60€	SSKT067 42,90€
690	Enduro 690 R	09-21	41221026 36,60€	SSKT067 42,90€
MONTESA				
250	Cota 315R 250	97-00	41221021 41,30€	SSKH399 42,90€
250	Cota 4RT 250	05-13	41221021 41,30€	SSKH399 42,90€
360	Cota 315R 360	01-04	41221021 41,30€	SSKH399 42,90€
Rieju				
	MR250	22-22	41221056 44,40€	
300	MR300	21-22	41221056 44,40€	
300	MR300 Ranger	22-22	41221056 44,40€	
SHERCO				
50	Enduro 50	03-13	41221022 36,60€	SSKK216 38,90€
50	SE 0.5 50	09-16	41221022 36,60€	SSKK216 38,90€
80	ST 0.8 80	09-13	41221022 36,60€	SSKK216 38,90€
125	SE 125-R	18-22	41221024 41,30€	SSKC012 42,90€
125	ST 1.25 125	09-17	41221047 32,60€	SSKT068 28,90€
125	ST 125	18-22	41221047 32,60€	SSKT068 28,90€
125	TY 125 Classic	19-21	41221022 36,60€	SSKK216 38,90€
125	X-Ride 125	11-19	41221022 36,60€	SSKK216 38,90€
200	Sherco 2.0 200	03-06	41221047 32,60€	SSKT068 28,90€
250	Enduro 2.5 i 250	05-11	41221024 41,30€	SSKC012 42,90€
250	SC250	19-19	41221024 41,30€	SSKC012 42,90€
250	SCF250	19-19	41221024 41,30€	SSKC012 42,90€
250	SE 2.5i-F 250	09-13	41221024 41,30€	SSKC012 42,90€
250	SE-R 250	14-22	41221024 41,30€	SSKC012 42,90€
250	SE-R 250 Factory	14-22	41221024 41,30€	SSKC012 42,90€

ROULEMENTS COLONNE DE DIRECTION



Cyl	Modèle	Année	 € T.T.C.	 € T.T.C.
250	SEF-R 2,5 250 4T	14-22	41221024 41,30€	SSKC012 42,90€
250	SEF-R 2,5 250 4T Factory	14-22	41221024 41,30€	SSKC012 42,90€
250	Sherco 2.5 250	98-14	41221047 32,60€	SSKT068 28,90€
250	ST 2.5 250	09-17	41221047 32,60€	SSKT068 28,90€
250	ST 250	18-22	41221047 32,60€	SSKT068 28,90€
250	SX 250 2,5i-F	09-11	41221024 41,30€	SSKC012 42,90€
290	Sherco 2.9 290	01-15	41221047 32,60€	SSKT068 28,90€
290	ST 2.9 290	09-13	41221047 32,60€	SSKT068 28,90€
290	X-Ride 290	11-19	41221022 36,60€	SSKK216 38,90€
300	SE-R 3,0	13-16	41221024 41,30€	SSKC012 42,90€
300	SE-R 3,0 i	10-12	41221024 41,30€	SSKC012 42,90€
300	SE-R 300	15-22	41221024 41,30€	SSKC012 42,90€
300	SE-R 300 Factory	13-22	41221024 41,30€	SSKC012 42,90€
300	SEF-R 300 4T	14-22	41221024 41,30€	SSKC012 42,90€
300	SEF-R 300 4T Factory	14-22	41221024 41,30€	SSKC012 42,90€
300	ST 3,0 Factory	14-16	41221047 32,60€	SSKT068 28,90€
300	ST 3.0 2T	13-17	41221047 32,60€	SSKT068 28,90€
300	ST 3.0R 2T	13-13	41221024 41,30€	SSKC012 42,90€
300	ST 3.0R 2T	13-13	41221047 32,60€	SSKT068 28,90€
300	ST 3.0R 2T	14-14	41221024 41,30€	SSKC012 42,90€
300	ST 3.0R 2T	14-14	41221047 32,60€	SSKT068 28,90€
300	ST 300	18-22	41221047 32,60€	SSKT068 28,90€
320	Sherco 3.2 320	03-08	41221047 32,60€	SSKT068 28,90€
320	ST 3.2-F 320	09-13	41221047 32,60€	SSKT068 28,90€
450	Enduro 4.5i 450	04-08	41221024 41,30€	SSKC012 42,90€
450	SE 4.5i-F 450	09-13	41221024 41,30€	SSKC012 42,90€
450	SEF-R 450	17-21	41221024 41,30€	SSKC012 42,90€
450	SEF-R 450 Factory	16-21	41221024 41,30€	SSKC012 42,90€
450	SM 4.5i-F 450	09-13	41221024 41,30€	SSKC012 42,90€
450	Supermotard 4.5i 450	05-08	41221024 41,30€	SSKC012 42,90€
500	SCF500	19-19	41221024 41,30€	SSKC012 42,90€
500	SEF-R 500	20-21	41221024 41,30€	SSKC012 42,90€
500	SEF-R 500 Factory	20-21	41221024 41,30€	SSKC012 42,90€
510	Enduro 5.1i 510	06-08	41221024 41,30€	SSKC012 42,90€
510	SE 5.1i-F 510	09-11	41221024 41,30€	SSKC012 42,90€
510	SM 5.1i-F 510	09-13	41221024 41,30€	SSKC012 42,90€
510	Supermotard 5.1i 510	07-08	41221024 41,30€	SSKC012 42,90€
SUZUKI				
50	JR 50	04-07	41221073 30,70€	
50	JR 80	01-01	41221042 86,10€	
65	RM65	03-06	41221022 36,60€	SSKK216 38,90€
70	DR-Z 70 L	12-19	41221042 86,10€	
80	RM80	80-85	41221042 86,10€	
80	RM80	90-01	41221006 39,90€	
85	RM85 / L	02-22	41221006 39,90€	
110	DRZ110	01-07	41221040 52,00€	
125	DR-Z 125 /L	03-15	41221006 39,90€	
125	DR-Z 125 L	16-22	41221006 39,90€	
125	RM125	75-78	41221005 98,70€	
125	RM125	79-80	41221007 52,10€	
125	RM125	81-86	41221019 90,90€	
125	RM125	88-88	41221004 39,50€	SSKK211 42,90€
125	RM125	89-90	41221024 41,30€	SSKC012 42,90€
125	RM125	91-92	41221001 44,50€	SSKY319 42,90€
125	RM125	93-04	41221013 52,70€	
125	RM125	05-13	41221048 54,80€	
250	DR-Z 250	01-10	41221013 52,70€	
250	RM-Z 250	04-06	41221023 39,90€	SSKK210 42,90€
250	RM-Z 250	07-22	41221058 109,90€	SSKS300 42,90€
250	RM250	76-78	41221005 98,70€	
250	RM250	79-80	41221007 52,10€	
250	RM250	81-86	41221019 90,90€	
250	RM250	88-88	41221004 39,50€	SSKK211 42,90€
250	RM250	89-90	41221024 41,30€	SSKC012 42,90€
250	RM250	91-92	41221001 44,50€	SSKY319 42,90€



ROUEMENTS COLONNE DE DIRECTION

Cyl	Modèle	Année	 € T.T.C.	 € T.T.C.
250	RM250	93-04	41221013 52,70€	
250	RM250	05-08	41221048 54,80€	
250	RMX250	89-90	41221024 41,30€	SSKC012 42,90€
250	RMX250	91-92	41221001 44,50€	SSKY319 42,90€
250	RMX250	93-01	41221013 52,70€	
400	DR-Z 400 /S	00-09	41221013 52,70€	
400	DR-Z 400 E	00-07	41221013 52,70€	
400	RM400	78-80	41221004 39,50€	SSKK211 42,90€
450	RM-Z 450	05-07	41221048 54,80€	
450	RM-Z 450	08-22	41221058 109,90€	SSKS300 42,90€
450	RMX450 Z	10-15	41221058 109,90€	SSKS300 42,90€
500	RM500	83-85	41221019 90,90€	
TM				
125	Cross MX125	98-01	41221003 41,30€	SSKT069 42,90€
125	Cross MX125	02-11	41221010 55,60€	
125	Enduro 125	02-04	41221010 55,60€	
125	Enduro EN125	05-11	41221010 55,60€	
250	Cross 250 /F	02-11	41221010 55,60€	
250	Enduro 250 /F	02-11	41221010 55,60€	
300	Cross 300	01-01	41221003 41,30€	SSKT069 42,90€
300	Cross 300	02-11	41221010 55,60€	
300	Enduro 300	01-01	41221003 41,30€	SSKT069 42,90€
300	Enduro 300	02-11	41221010 55,60€	
450	Cross 450 F	04-11	41221010 55,60€	
450	Enduro 450 F	04-11	41221010 55,60€	
YAMAHA				
50	PW50	80-21	41221064 68,00€	
50	TT-R50 E	18-22	41221008 47,90€	
60	YZ60	85-85	41221008 47,90€	
65	YZ 65	18-22	41221022 36,60€	SSKK216 38,90€

ROUEMENTS COLONNE DE DIRECTION

Cyl	Modèle	Année	 € T.T.C.	 € T.T.C.
80	PW80	83-13	41221008 47,90€	
80	YZ80	74-83	41221008 47,90€	
80	YZ80	84-92	41221033 39,90€	
80	YZ80	93-01	41221022 36,60€	SSKK216 38,90€
85	YZ85 / L	02-22	41221022 36,60€	SSKK216 38,90€
90	TT90 R	00-03	41221008 47,90€	
100	RT100	90-90	41221008 47,90€	
110	TT-R110 E	08-22	41221033 39,90€	
125	TT125 R	00-22	41221033 39,90€	
125	YZ125	76-76	41221008 47,90€	
125	YZ125	77-86	41221004 39,50€	SSKK211 42,90€
125	YZ125	87-95	41221024 41,30€	SSKC012 42,90€
125	YZ125	96-22	41221001 44,50€	SSKY319 42,90€
230	TT230R	05-16	41221004 39,50€	SSKK211 42,90€
250	TT250 R	99-07	41221024 41,30€	SSKC012 42,90€
250	WR250	91-97	41221024 41,30€	SSKC012 42,90€
250	WR250 F	01-22	41221001 44,50€	SSKY319 42,90€
250	WR250 Z	91-97	41221024 41,30€	SSKC012 42,90€
250	YZ250	80-87	41221004 39,50€	SSKK211 42,90€
250	YZ250	88-95	41221024 41,30€	SSKC012 42,90€
250	YZ250	96-22	41221001 44,50€	SSKY319 42,90€
250	YZ250 F	01-22	41221001 44,50€	SSKY319 42,90€
250	YZ250 X	16-19	41221001 44,50€	SSKY319 42,90€
350	TT350	86-97	41221004 39,50€	SSKK211 42,90€
400	WR400 F	98-01	41221001 44,50€	SSKY319 42,90€
400	YZ400 F	98-99	41221001 44,50€	SSKY319 42,90€
426	WR426 F	01-02	41221001 44,50€	SSKY319 42,90€
426	YZ426 F	00-02	41221001 44,50€	SSKY319 42,90€
450	WR450 F	03-22	41221001 44,50€	SSKY319 42,90€
450	YZ450 F	03-22	41221001 44,50€	SSKY319 42,90€



Roulements

Référence	Désignation	Dimensions	€ T.T.C.
4160037	6003 2NSE C3	17x35x10	7,33 €
4160040	6004 C3	20x42x12	6,61 €
4160053	6005 C3	25x47x12	7,02 €
4160077	6007 2NSE C3	35x62x14	14,87 €
4162003	6200 C3	10x30x09	4,46 €
4162019	6201 ZZE	12x32x10	5,28 €
4162030	6203	17x40x12	5,80 €
4162044	6204 C4	20x47x14	8,10 €
4163027	6302 2NSE C3	15x42x13	8,35 €
4163030	6303	17x47x14	7,27 €
4163037	6303 2NSE C3	17x47x14	9,38 €
4163049	6304 ZZE	20x52x15	10,25 €
4169047	6904 2NSE	20x37x09	15,05 €
4169057	6905 2NSE	25x42x09	15,05 €
4169067	6906 2NSE	30x47x09	13,55 €
4160000	6000 C3	10x26x08	4,40 €
4160007	6000 2NSE C3	10x26x08	5,33 €
4160027	6002 2NSE	15x32x09	5,69 €
4160029	6002 ZZE	15x32x09	5,69 €
4160030	6003	17x35x10	6,10 €
4160047	6004 2NSE C3	20x42x12	7,74 €
4160057	6005 2NSE C3	25x47x12	8,26 €
4162007	6200 2NSE C3	10x30x09	5,33 €
4162017	6201 2NSE C3	12x32x10	5,84 €
4162018	6201 ZE	12x32x10	5,08 €
4162023	6202 C3	15x35x11	5,12 €
4162027	6202 2NSE C3	15x35x11	6,36 €
4162037	6203 2NSE C3	17x40x12	6,30 €
4162043	6204 C3	20x47x14	7,38 €
4162047	6204 2NSE C3	20x47x14	8,51 €
4163007	6300 2NSE	10x35x11	6,25 €
4163017	6301 2NSE	12x37x12	7,54 €
4163020	6302	15x42x13	6,92 €
4163033	6303 C3	17x47x14	7,27 €
4163047	6304 2NSE	20x52x15	10,09 €
4160017	6001 2NSE C3	12x28x08	5,38 €
4160050	6005	25x47x12	7,02 €
4160067	6006 2NSE C3	30x55x13	9,68 €
416087	608-2RSH/C3LHT23	8x22x7	7,32 €
4162013	6201 C3	12x32x10	4,76 €
4162020	6202	15x35x11	5,12 €
4162029	6202 ZZE	15x35x11	5,64 €
4162033	6203 C3	17x40x12	5,80 €
4162049	6204 ZZE	20x47x14	7,79 €
4162053	6205 C3	25x52x15	8,35 €
4162057	6205 2NSE C3	25x52x15	9,84 €
4162060	6206 C3	30x62x16	11,69 €
4163010	6301	12x37x12	6,66 €
4163029	6302 ZZE	15x42x13	7,49 €
4163040	6304	20x52x15	8,71 €
4163057	6305 2NSE C3	25x62x17	14,60 €
4163227	63/22 2NSE C3	22x56x16	17,02 €

Roulements colonne de direction

Référence	Désignation	Dimensions	€ T.T.C.
413200526	E-32005-JS/26	26x47x11,5x15x16	28,85 €
4132028	E-320/28-J	28x52x12x16x16	24,60 €
4132005	E-32005-J	25x47x11,5x15x15	26,81 €
4132006	E-32006-J	30x55x13,0x17x17	27,37 €

Joint SPI de fourche

Référence	Dimensions	Caractéristiques	€ T.T.C.
455068	25,7x35x7/9	MGR-RSD2	9,70 €
455002	25,7x37x10,5	MGR-RSD	9,70 €
455001	25x35x9	MGR-RSD	10,80 €
455004	26x37x10,5	MGR-RSD	9,90 €
455204	26x37x10,5	MGR-RSA	21,30 €
455080	27x39x10,5	MGR-RSD	11,80 €
455079	28x38x7	MGR-RSD	11,80 €
455112	28x38x7/9	MGR-RSD2	29,80 €
455008	28x40x10,5	NOK MGR-MRSD	12,50 €
455009	28x41x10,5	MGR-RSD	8,90 €
455075	29,8x40x7	MGR-RSD	12,80 €
455198	29x40,5x10,5	MGR-RSA	21,65 €
455010	29x41x11	MGR-RSA	12,80 €
455083	30x38/42x12	MGR-RSD	12,80 €
455172	30x39/43x11,6	MGR-RSA	14,60 €
455012	30x40,5x10,5	MGR-RSA	13,00 €
455107	30x40x7/9	MGR-RSD2	18,50 €
455011	30x40x8/9	MGR-RSD2	10,40 €
455013	30x42x10,5	MGR-RSD	13,30 €
455149	30x42x11	MGR-RSA	19,00 €
455017	31,7x42x7/9	MGR-RSD2	10,40 €
455106	31,7x42x9	MGR-RSD	18,30 €
455014	31x41x9/11	MGR-RSD2	10,40 €
455015	31x43x10,3	MGR-RSA	10,40 €
455016	31x43x12,5	MGR-RSD	10,40 €
455109	32x42x7	MGR-RS	22,10 €
455066	32x42x8/9	MGR-RSD2	10,40 €
455134	32x43x10,5	MGR-RSA	15,40 €
455018	32x43x12,5	MGR-MRSD	10,40 €
455019	32x44x10,5	MGR-RSD	10,40 €
455188	32x44x10,5	MGR-RSA	11,65 €
455074	32x44x11	MGR-RSD	13,70 €
455184	32x45x8/10	MGR-RSA	15,70 €
455133	33x45x10	NOK MGR-RSD	16,40 €
455024	33x45x11	MGR-RSD	10,40 €
455023	33x45x8/10,5	NOK MGR-RSD2	16,30 €
455168	33x45x8/10,5	MGR-RSA	14,90 €
455025	33x46x10,5	MGR-RSD	9,50 €
455026	33x46x11	MGR-RSA	12,50 €
455137	33x46x11	MGR-RSA	24,50 €

JointS SPI de fourche (suite)

Référence	Dimensions	Caractéristiques	€ T.T.C.
455136	34,74x47x9	MGR-RSD	16,00 €
455028	34x46x10,5	MGR-MRSD	11,10 €
455197	34x48x11	MGR-RSA	31,00 €
455144	35,5x48x11	MGR-RSA	17,50 €
455202	35x45,99x11 12-16	MGR-RSA	14,20 €
455115	35x46x11	MGR-RSD2	16,30 €
455169	35x47x10	MGR-RSA	15,90 €
455061	35x47x7,5/10	MGR-RSA	17,10 €
455062	35x47x7/9	MGR-RSD2	11,10 €
455029	35x47x9,5/10,5	MGR-RSD	10,40 €
455031	35x48x10,5	MGR-RSD	10,40 €
455032	35x48x11	MGR-RSA	12,50 €
455135	35x48x11	MGR-RSA	17,40 €
455146	35x48x8/10,5	MGR-RSD2	17,80 €
455208	35x48x8/10,5	MGR-RSA	34,20 €
455171	35x48x8/10,5	MGR-RSA	16,00 €
455034	36x46x7/9	MGR-RSD2	10,40 €
455036	36x48x10,5	MGR-RSD	11,10 €
455132	36x48x11	MGR-RSD	19,40 €
455037	36x48x11/12,5	MGR-RSD2	11,80 €
455035	36x48x8/9,5	MGR-RSD2	11,10 €
455091	36x48x8/9,5	NOK MGR-RSD2	31,50 €
455187	36x49x8/10,5	MGR-RSA	22,80 €
455072	36x50x7/9	MGR-RSD2	12,10 €
455038	37x48x10,5/12	MGR-RSD	12,10 €
455039	37x48x12,5/13,5	MGR-RSD2	12,80 €
455174	37x49,1x8/10,5	MGR-RSA	24,50 €
455040	37x49x8/9,5	MGR-RSD2	11,10 €
455042	37x50x11	MGR-RSA	11,80 €
455143	37x50x11	MGR-RSA	31,80 €
455190	37x50x11	MGR-RSA	30,90 €
455046	38,5x48x7	MGR-RS	13,70 €
455196	38,5x48x7	MGR-RSD	31,50 €
455084	38x48x10	MGR-RSD	11,10 €
455044	38x50x10,5	MGR-RSD	10,30 €
455063	38x50x7/8	MGR-RSD2	11,10 €
455043	38x50x8/9,5	MGR-RSD2	10,30 €
455152	38x50x8/9,5	MGR-RSD2	35,70 €
455045	38x52x11	MGR-RSA	13,60 €
455047	39x51x8/10,5	MGR-RSD2	13,60 €
455186	39x52x10/10,5	MGR-RSD2	15,70 €
455048	39x52x11	MGR-RSA	12,80 €
455065	40x49,5x7/9,5	MGR-RSA	17,10 €
455138	40x52,2x10/10,5	NOK MGR-RSD2	21,00 €
455087	40x52,2x9,5/10,5	MGR-RSD	44,60 €
455199	40x52x10	MGR-RSA	11,70 €
455050	40x52x10/10,5	MGR-RSD2	11,40 €
455049	40x52x8/10,5	MGR-RSD2	11,40 €
455104	41,5x54x10,5/11,2	NOK MGR-RSD2	31,30 €
455064	41,7x55x10/10,5	MGR-RSD2	11,40 €
455194	41,7x55x7,5/10	MGR-RSA	41,60 €
455067	41,7x55x8/10	MGR-RSD2	11,40 €

Référence	Dimensions	Caractéristiques	€ T.T.C.
455051	41x51x6	MGR-RS	13,70 €
455183	41x52,2x11	MGR-RSA	25,30 €
455090	41x53,1x8/9,5	NOK MGR-RSD2	32,20 €
455053	41x53x10,5	MGR-RSD	11,80 €
455167	41x53x11	MGR-RSD	18,20 €
455148	41x53x8/10,5	NOK MGR-RSA	36,70 €
455166	41x53x8/10,5	MGR-RSA	19,50 €
455052	41x53x8/9,5	NOK MGR-RSD2	11,40 €
455054	41x54x11	MGR-RSA	13,60 €
455157	42x54x11	MGR-RSA	17,50 €
455156	42x54x11	MGR-RSD2	17,50 €
455103	43x52,7x7/8	MGR-RSD2	49,10 €
455101	43x52,7x9,5/10,3	MGR-RSD2	52,10 €
455191	43x52,9x9/11,4	MGR-RSA	19,00 €
455193	43x53,8x9,6/11,6	MGR-RSA	32,10 €
455127	43x53x9,5	NOK MGR-RSD	44,50 €
455056	43x54x11	MGR-RSD	11,80 €
455093	43x54x11	NOK MGR-RSD	30,50 €
455170	43x54x11	MGR-RSA	17,50 €
455092	43x54x9,5/10	NOK MGR-RSD2	32,70 €
455055	43x54x9,5/10,5	MGR-RSD2	13,60 €
455057	43x55,1x9,5/10	MGR-RSD2	11,80 €
455089	43x55,1x9,5/10	NOK MGR-RSD2	32,20 €
455058	43x55x10,5	MGR-RSD	11,80 €
455154	43x55x11/14	NOK MGR-RSD2	27,10 €
455153	43x55x9,5/10,5	NOK MGR-RSA	35,20 €
455159	43x55x9,5/10,5 J	MGR-RSA	17,50 €
455160	43x55x9,5/10,5 K	MGR-RSA	17,50 €
455161	43x55x9,5/10,5 L	MGR-RSA	17,50 €
455059	45x57x11	MGR-RSA	17,10 €
455088	45x57x11	NOK MGR-RSA	32,70 €
455163	45x57x11	MGR-RSA	23,65 €
455085	45x58x11	NOK MGR-RSA	32,70 €
455069	45x58x8,5/11	MGR-RSA	13,70 €
455116	46x58,1x10,5	NOK MGR-RSA	42,40 €
455105	46x58,1x10,5/11,5	NOK MGR-RSD2	38,70 €
455086	46x58,1x9,5/11,5	NOK MGR-RSA	29,50 €
455060	46x58x10,5/11,5	MGR-RSD2	16,40 €
455207	46x58x8,5/11,5	NOK MGR-RSA	43,90 €
455076	47x58x10	NOK MGR-RSD	16,80 €
455122	47x58x10	NOK MGR-RSD	24,00 €
455102	48x57,7x9,5/10,3	MGR-RSD2	54,20 €
455141	48x57,9x11,5	NOK MGR-RSA	45,60 €
455139	48x58,1x8,5/10,5	NOK MGR-RSA	31,70 €
455123	48x58,1x8,5/10,5	NOK MGR-RSA	29,90 €
455200	48x58x8,5/10	MGR-RS	19,00 €
455128	48x58x9	NOK MGR-RSD	55,30 €
455124	48x59x10,5	MGR-RSD2	32,30 €
455129	48x61x11	NOK MGR-RSD	56,20 €
455073	49x60x10	NOK MGR-RSD	22,90 €
455077	50x59,6x7/10,5	MGR-RSA	17,10 €
455078	50x63x11	NOK MGR-RSA	27,00 €

Le nécessaire

Tout ce dont vous avez besoin pour l'entretien de votre moto. Retrouvez les housses de protection, l'immatriculation, mais aussi la valise diagnostic et tous les outils qui font la différence.



Housse de protection TOPLINE modèle COVER+

ATELIER ACCESSOIRES

ANTIVOL XENA /
HOUSSE DE PROTECTION /
IMMATRICULATION /
ACCESSOIRES /



XENA	660
TOPLINE	670
SPM	672
MOTORSCAN	676
ACCESSOIRES	680

ANTIVOL U



XSU 69



U 69 - XSU69

69,90 €
T.T.C.

- Anse 16mm anti-torsion
- Corps en acier inoxydable
- Clé de sécurité
- Résistant aux attaques par basse température
- Classe SRA
- Poids : 940 g

XSU 102



- Anse 18mm anti-torsion
- Corps en acier inoxydable
- Clé de sécurité
- Résistant aux attaques par basse température
- Poids : 1 600 g

U 102 - XSU102

79,90 €
T.T.C.

XSU 250



- Anse 18mm anti-torsion
- Corps en acier inoxydable
- Clé de sécurité
- Résistant aux attaques par basse température
- Poids : 2 380 g

U 250 - XSU250

90,90 €
T.T.C.

XSU 310



- Anse 18mm anti-torsion
- Corps en acier inoxydable
- Clé de sécurité
- Résistant aux attaques par basse température
- Poids : 2 460 g

U 310 - XSU310

99,90 €
T.T.C.

Socle d'ancrage

NOUVEAUTÉ

Caractéristiques

- Acier trempé, finition brossée
- Rotation pratique à 360 degrés
- Anse repliable, faible encombrement hors utilisation
- Point d'attache fixe et résistant, simple à utiliser et à installer. Fixation innovante par cheville (fournie)
- Résiste à la corrosion et aux attaques par le froid (spray cryogène)

Socle - XGA
99,90 €
I.T.C.

Vendu avec kit de montage



Chaîne + XSU 69

Chaîne 120cm + XSU 69

Chaîne 120 + U - XSC120
139,90 €
I.T.C.

Chaîne lasso 120cm + U69

Chaîne 120 lasso + U - XSC120L
140,90 €
I.T.C.

Caractéristiques :

- Chaînes en acier trempé
- Ø maillon de chaîne : 14 mm
- Résistance à la corrosion
- Sécurité maximale
- Résistance aux attaques par basse température
- "Rip-Stop" housse de protection
- **U et chaîne sont certifiés SRA**

BLOQUE DISQUE ALARME

 Bluetooth®



Bloque disque alarme Bluetooth®

Haute sécurité, alarme ultra-puissante !

Pilotez votre antivol !

Configurez et contrôlez tous les paramètres de votre bloque disque alarme XENA depuis votre smartphone via Bluetooth grâce à l'application GRATUITE XENA BLE Lock.

En cas de perte de clés, rendez-vous sur xena.fr

SMARTPHONE CONTROL



App XENA BLE Lock gratuite

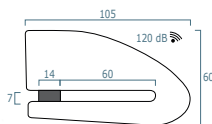

XX15

**CLASSE
SRA**

XX14

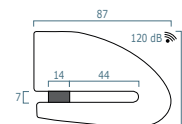
**CLASSE
SRA**
XX15* Bluetooth® - XX15BLE
120,90 €
I.T.C.
XX14* Bluetooth® - XX14BLE
118,90 €
I.T.C.
**CLASSE
SRA**

**120 dB
ALARM**

Tous les bloque disques alarme XENA sont certifiés **classe SRA** et sont équipés d'une **alarme d'une puissance de 120 dB**.

Caractéristiques :

- Acier inoxydable 304
- Double verrouillage
- Corps et cylindre de clés inviolables
- Désactivation automatique de l'alarme
- Capteurs de mouvements
- Accessoire compatible : adaptateur de chaîne
- **Classe SRA**

Contenu de la boîte :

Batterie Lithium CR2
 3 clés
 Manuel d'utilisation

XX10

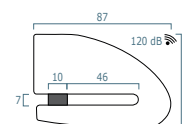
**CLASSE
SRA**
XX10* Bluetooth® - XX10BLE
114,90 €
I.T.C.

* Eco-participation 0,15 € H.T.

BLOQUE DISQUE ALARME



XX15

Axe de 14mm renforcé au carbure
Poids : 768 g



XX15* - XX15

CLASSE
SRA

99,90 €
T.T.C.

XX15 carbone

NOUVEAUTÉ



CLASSE
SRA

XX15* carbone - XX15CF

109,90 €
T.T.C.

XX14

Axe de 14mm renforcé au carbure
 Poids : 612 g



XX14* - XX14

98,90 €
T.T.C.

XX10

Axe de 10mm renforcé au carbure
 Poids : 602 g



XX10* - XX10

94,40 €
T.T.C.



120 dB
 ALARM

Tous les bloque disques alarme XENA sont certifiés **classe SRA** et sont équipés d'une **alarme d'une puissance de 120 dB**.

Caractéristiques :

- Acier inoxydable 304
- Double verrouillage
- Corps et cylindre de clés inviolables
- Désactivation automatique de l'alarme
- Capteurs de mouvements
- Accessoire compatible : adaptateur de chaîne
- **Classe SRA**

Contenu de la boîte :

Batterie Lithium CR2
 3 clés
 Manuel d'utilisation

XX10 carbone

NOUVEAUTÉ



XX10* carbone - XX10CF

99,90 €
T.T.C.

Une serrure deux systèmes

La haute sécurité à double verrouillage, les bloque disques alarme XENA émettent un son puissant de 120 dB.

La solution robuste, légère, intelligente et puissante pour moto et scooter.

* Eco-participation 0,15 € H.T.

X series

Qualité de conception, de matériaux et de finition.

X1 inox

Axe de 6 mm en acier trempé - Poids : 421 g

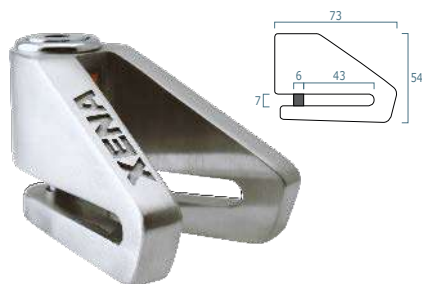

X1 inox - X1

35,50 €
T.T.C.

X2 inox



CLASSE
SRA

X2 inox - X2

65,90 €
T.T.C.

Un classique.

L'antivol inviolable par excellence, le X2 XENA n'a plus à faire ses preuves et est même une référence incontournable.

Dimensions du X2 :

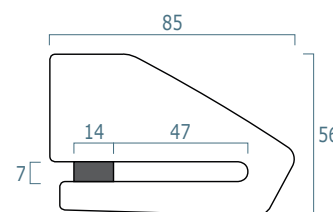

NOUVEAUTÉ

Une touche de couleur en plus ?



666

Caractéristiques :

- Acier inoxydable 304
- Verrouillage rapide
- Broche en acier trempé de 14mm
- Corps et cylindre de clés résistant aux attaques par basse température
- Poids : 695g

Contenu de la boîte :

3 clés
Manuel d'utilisation

X2 color series

NOUVEAUTÉ

X2 or

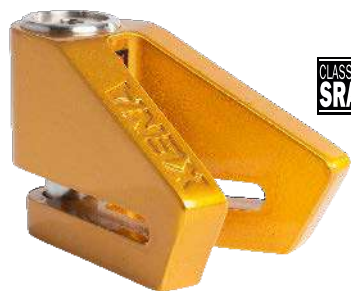

CLASSE
SRA

X2 or - X2GD

59,90 €
T.T.C.

X2 orange



CLASSE
SRA

X2 orange - X2HD

59,90 €
T.T.C.

X2 ROSE



CLASSE
SRA

X2 rose - X2RH

59,90 €
T.T.C.

X2 blanc



CLASSE
SRA

X2 blanc - X2WH

59,90 €
T.T.C.

X2 noir mat



CLASSE
SRA

X2 noir mat - X2BK

59,90 €
T.T.C.

X2 carbone



CLASSE
SRA

X2 carbone - X2CF

69,90 €
T.T.C.



XENA
INTELLIGENT SECURITY



ACCESSOIRES

Support pour bloque disque

NOUVEAUTÉ



Support - XLH14

Crochet de fixation Ø3,3cm

18,90 €
I.T.C.



Adaptateurs



XCAXX pour câble



XCA15 pour chaîne

Adaptateur pour câble - XCAXX

21,30 €
I.T.C.

Adaptateur pour chaîne - XCA15

Câble



Vendu avec adaptateur XCAXX

Câble et adaptateur - XXA150

31,50 €
I.T.C.

Housses



Néoprène pour XX10 et XX14 - XLP1

Néoprène pour XX15 et X2 - XLP2

8,50 €
I.T.C.

Cordon de rappel



Cordon de rappel - XCORDON02

5,90 €
I.T.C.

XENA X™
INTELLIGENT SECURITY

**FORGÉ POUR LA RUE
ET CONNECTÉ À VOTRE SMARTPHONE**



**CLASSE
SRA**

BLOQUE DISQUE AVEC ALARME (120DB),
COMMANDÉ À DISTANCE DEPUIS VOTRE SMARTPHONE
VIA UNE CONNEXION BLUETOOTH.



SMARTPHONE
CONTROL



DISTRIBUTEUR EXCLUSIF

03 85 51 45 45

www.moraco.fr

MORACO
Motorcycle parts

HOUSSE DE PROTECTION



Universelle

Étanchéité parfaite quelle que soit la météo

Protéger votre moto contre les intempéries ? Topline a la solution : la housse universelle. C ouverture doublée garantit une étanchéité complète.



Housse universelle

59,90 €
I.T.C.

Caractéristiques

- Polyester étanche 300D
- Ventilation anti condensation
- Renfort échappement
- Coutures doubles
- Oeillettes pour passage antivol

M HOUSSM01
L HOUSSL01
XL HOUSSXL01
XXL HOUSSXXL01

COVER+ NOUVEAUTÉ

Pour l'intérieur comme pour l'extérieur

Des matériaux ultra résistants, pour une protection optimale. Trou pour passage antivol, élastiques de maintien et sac de transport inclus

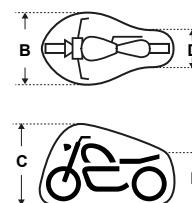

Mesures en cm

	A	B	C	D	E
S	203	83	119	35	80
M	229	99	125	35	90
L	246	104	127	35	92
XL	277	104	141	35	102

Housse COVER+

Caractéristiques

- Protection intempéries, poussières, UV
- Coutures doubles
- Élastiques et sangle de maintien
- Oeillettes pour passage antivol
- Sac de rangement

S 942001 29,90 €
I.T.C.
M 942002 32,90 €
I.T.C.
L 942003 34,90 €
I.T.C.
XL 942004 42,90 €
I.T.C.

Tailles de housse universelle

BMW	C 600 Sport / C 650 GT / F 650 CS Scarver / F 650 GS / F 800 S / R 100 / R 1100 S / S 1000 RR	L
	F 700 GS / F 800 GS / F 800 R / F 800 ST / G 650 GS / K 1 / K 100 LT / K 100 RS / K 100 RT / K 1100 LT / K 1100 RS / K 1200 R / K 1200 R SPORT / K 1200 RS / K 1200 S / K 1300 R / K 1300 R / K 75 / K 75 C / K 75 RT / K 75 S / R 1100 GS / R 1100 RT / R 1150 RT / R 1150 GS ADVENTURE / R 1200 GS / R 1200 R / R 1200 RT / K 1600 GT / R 1200 GS ADVENTURE	XL
	K 100 / K 1200 GT / K 1200 LT / R 1200 CL / K 1300 GT / K 1600 GTL	XXL
DUCATI	Monster 1100 evo / Monster 20th Anniversary / Monster 696 / Monster 796 / Monster diesel / Superbike 848 evo	M
	749 / Hypermotard 821 / Streetfighter 848 / Streetfighter S / Superbike 1199 Panigale / Superbike 1199 Panigale R / Superbike 1199 Panigale S / Superbike 1199 Panigale Tricolore / Superbike 848 evo Corse SE	L
	Diavel / Diavel AMG / Diavel carbon / Diavel cromo / Diavel dark / Diavel strada / Hypermotard 1100 evo / Hypermotard 1100 evo SP / Hypermotard 796 / Hyperstrada	XL
	Multistrada 1200 / Multistrada 1200 S Granturismo / Multistrada 1200 Pikes peak / Multistrada 1200 S Sport / Multistrada 1200 S Touring	XXL
HARLEY DAVIDSON	Iron 883	L
	1200 Custom / 883 roadster / Forty-eight / Low rider / Seventy-two / Softail Slim / Street Bob / Super glide custom / Superlow / Superlow 1200 T / Switchback / XL 1200 C	XL
	Breakout / CVO Breakout / CVO limited / CVO Road glide custom / CVO Road king / CVO Softail deluxe / CVO Ultra classic electra glide / Electra glide Ultra classic / Electra glide Ultra limited / Fat bob / Fat boy / Fat boy special / Heritage softail classic / Night rod special / Road king 110th Anniversary edition / Road king classic / Softail deluxe / Street glide / Ultra limited / V-Rod muscle / Wide glide	XXL
HONDA	CRF100F / CRF150 RB / CRF70F / MSX125 / PCX125/150 / VISION 110	M
	CB1000R / CB200 / CB600F HORNET / CBF125 / CBF600 Tophalf ABS / CBR600 Blackbird / CBR1000RR Fireblade / CBR250R / CBR600F / CBR600 RR / CBR 954 Fireblade / COTA 4 RT / CRF250R / CRF450X / Crossrunner / PS150i / SH150i / SH300i ABS / VFR750 / VFR800 VTEC ABS / VTR 1000 F / XR 125	L
	CB1300 / CB1300S ABS / CB650 / CBF1100F ABS / CMX450 rebel / CRF250L / CRF450R / Deauville NTV 650 / NC700D Integra ABS / NC700S ABS / NC700X ABS / NT700V Deauville ABS / NX650 Dominator / Pacific coast 800 / Shadow VLX 600 / Silverwing 600 / SW-T400 ABS / SW-T600 / VFR1200F Dual Clutch Transmission / VFR1200X Cross Tourer / VRF 1200 F / VT750S / XL1000V Varadero / XL700V Transalp ABS	XL
	ST1100 / ST1300 Pan European ABS / VT1300CX ABS / VT750C Shadow ABS / VT750C2B Shadow Black Spirit / VT750DC Shadow Spirit ABS	XXL
KAWASAKI	D-Tracker 125 / KLX 110	M
	ER-6f / ER-6n / GPZ900 R / KLX125 / KLX450 R / KX250F / KX450F / Ninja 250 R / Ninja ZX-10R / Ninja ZX-6R / Ninja ZX-6R Performance / Versys / Versys City / Versys Tourer / W800 / W800 cafe style / W800 Special edition / Z1000 / Z1000 black ed. / Z1000 SX / Z1000 SX City / Z1000 SX Tourer / Z750 / Z750R / Z750R black ed. / ZZR1400 / ZZR1400 Performance	L
	1400GTR / 1400GTR Grand Tourer / KLX 250 / Versys 1000 / Versys 1000 Grand Tourer / VN800 Vulcan	XL
	VN1500 / VN1700 Classic / VN1700 Classic Tourer / VN1700 Light Tourer / VN1700 Voyager Custom / VN900 Classic / VN900 Classic Special ED. / VN900 Custom / VN900 Light Tourer / VN2000 Classic	XXL
SUZUKI	RM85 / RM85L / RM85 Talent cup	M
	BURGMAN 200 Executive / GLADIUS ABS / GN250 / GSF1200S / GSF600 / GSR750 / GSR750 STREET XTREME / GSX750F / GSXR1000 / GSXR600 / GSXR600 SE / GSXR750 / GSX1250 FA / GSX1250 FA TE / GSX650 FA / GSX650 FA Touring / HAYABUSA 1300 / INAZUMA 250 / SAVAGE 650 / RM-Z250 / RM250 Limited Ed. / RM-Z450 / RMX450Z / SIXTeen 150	L
	BURGMAN 400A / BURGMAN 400AZ / BURGMAN 650 A Executive / INTRUDER M1500 / NEW V-STROM 650A / V-STROM 650A / V-STROM 650A BR / V-STROM 650A Touring	XL
	INTRUDER C1800RT / INTRUDER C1800RT LC / INTRUDER C800 Classic / INTRUDER M1500 / INTRUDER M1800R / INTRUDER M1800RZ	XXL
TRIUMPH	BONNEVILLE / DAYTONA 675 / DAYTONA 675 R / SPEED TRIPLE / SPEED TRIPLE R / STREET TRIPLE / STREET TRIPLE R / THRUXTON / TIGER SPORT	L
	BONNEVILLE T100 / BONNEVILLE T100 BLACK / SCRAMBLER / THUNDERBIRD / THUNDERBIRD STORM / TIGER 800 / TIGER 800 XC / TIGER EXPLORER SPOKED WHEELS / TIGER EXPLORER XC / TROPHY SE	XL
	AMERICA / ROCKET / ROADSTER / ROCKET III Touring / SPEEDMASTER / THUNDERBIRD COMMANDER	XXL
YAMAHA	CYGNUS X125 / TT-R110E / TT-R50E / YZ85LW	M
	FAZER8 ABS / FAZER8 GT ABS / FZ1 ABS / FZ1 FAZER ABS / FZ8 50th Anniversary World GP / FZ8 ABS / FZS600 FAZER / MT-03 / MT-09 / TDM850 / TDM900A / XJ6 ABS / XJ6 Diversion ABS / XJ6 Diversion F ABS / XJR 1300 / XMAX 400 / XT 500 / YZ 125 / YZ 250F / YZF-R1 / YZF-R1 50th Anniversary World GP / YZF-R125 / YZF-R6 / YZF-R6 50th Anniversary World GP	L
	FJR1300A / FJR1300A EXPLORER / FJR1300AS / FJR1300AS EXPLORER / VIRAGO / WR450F / XJ900S / XT 1200 Z SUPER TENERE / XT 1200 Z SUPER TENERE EXPLORER / XT 1200 Z SUPER TENERE WORLDCROSSER / XT660R / XT660X / XT660Z SUPER TENERE EXPLORER ABS / XT660Z SUPER TENERE URBAN EXPLORER ABS / XT660Z TENERE / XT660Z TENERE ABS / XV750 / YZ450F	XL
	VMAX / XVS1300A MIDNIGHT STAR / XVS650A MIDNIGHT STAR	XXL

IMMATRICULATION



SPM, plus qu'une plaque, un concept

S.P.M. est le spécialiste du marquage et de l'identification minéralogique des véhicules.

Concept NR de haute qualité

- Homologation UTAC garantie
- Respect de la législation en vigueur
- Traçabilité intégrée
- Système Breveté



Plaque de 3 mm incassable



Traitement Anti-UV



Perte d'ilot impossible



Pas de contravention pour défaut de plaque



Une seule machine

Film en 1 seul élément !



Pliez le film en 2 pour une impression sur le matériel SPM standard.

Solution compacte

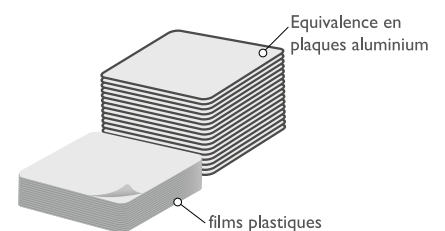

Toute les références disponibles en un minimum de place !

2x moins de stock !

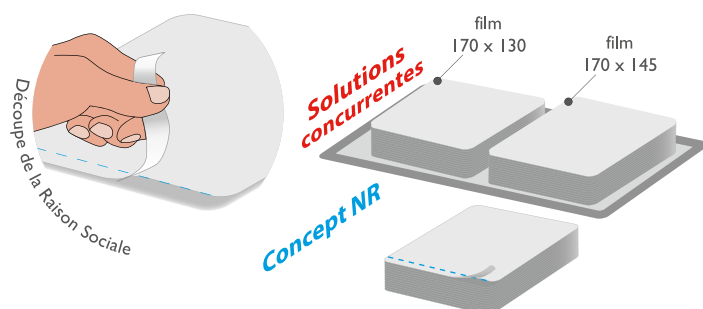

Plaques homologuées

Compatibles avec tout système laser

210 x 145 mm

Avec raison sociale



Référence

Film	6622100 + n° département
Plaque plexi	661210x145

210 x 130 mm

Sans raison sociale



Référence

Film	6622100 + n° département
Plaque plexi	661210x130

275 x 200 mm

Sans raison sociale



Référence

Film	6622100 + n° département
Plaque plexi	661210x130

Plaques auto

Avec raison sociale



Référence

Film	662AL0 + n° département
Plaque plexi	661AL

Plaques non homologuées

100 x 100 mm

Sans raison sociale



Référence

Film	662100X100
Plaque plexi	661100X100

Trapèze

Sans raison sociale



Référence

Film	662100X100T
Plaque plexi	661100X100T

Machines

Poste laser



Poste 205 PF

Lamineur 205 PF, guide réglable, clavier KP200 PRO, imprimante 243PRO AM A, rouleau, et guide pour réalisation de plaques autos et motos.



Consommables

Désignation : support et dimensions (L x H)	Référence	Quantité min.	€ H.T.	Dépannage
PLAQUES HOMOLOGUÉES				
	210 x 130	10	3,13 €	5,54 €
Plexi	210 x 145	10	3,25 €	5,82 €
	210 x 145 avec logo	10	3,75 €	
	210 x 145 Vierge	10	3,00 €	3,91 €
Bande	210 x 145 ou 130 (F)	10	2,71 €	4,82 €
	210 x 145 ou 130 (F + région et Dépt)	10	3,00 €	5,36 €
PLAQUES NON HOMOLOGUÉES				
Plexi	100 x 100	10	2,46 €	3,82 €
	100 x 100 Rouge	10	2,96 €	5,27 €
	100 x 100 Orange	10	2,96 €	5,27 €
	100 x 100 Jaune	10	2,96 €	5,27 €
Bande	100 x 100 Rose	10	2,96 €	5,27 €
	100 x 100 Vert	10	2,96 €	5,27 €
	100 x 100 Bleu	10	2,96 €	5,27 €
	100 x 100 Noir	10	2,96 €	5,27 €
	100 x 100 Vierge	10	2,45 €	4,36 €
Plexi	Trapèze 100 x 100 Vierge	10	2,17 €	3,82 €
Bande	Trapèze 100 x 100 Vierge	10	3,17 €	5,66 €
PLAQUES AUTOMOBILES HOMOLOGUÉES				
Plexi	520 x 110	100	4,75	8,45
	520 x 110 Vierge	100	3,58	6,36
Bande	520 x 110 (F)	100	3,83	6,81
	520 x 110 SIV (F + région et Dépt)	100	4,42	7,90
RIVETS				
	Boîte 400 Pcs Blanc 4 x 18,8 imperdables	400	55,83 €	
	Boîte 250 Pcs Noir 4 x 18,8 imperdables	250	55,83 €	
ROULEAU				
	Rouleau de transfert thermique longueur 300 m	1	67 €	



ÊTES-VOUS SÛR D'AVOIR
LE BON OUTIL DE DIAGNOSTIC?

MEMOBIKE 6050

EOS AUTOMOTIVE

MOTORSCAN®

DIAGNOSTIC MULTIMARQUES, RÉPARATIONS,
SERVICE ET RE-PROGRAMMATION.

- CONNECTIQUE FOURNIE POUR 70 MARQUES
- 2 MISES À JOUR PAR AN POUR LE PRIX D'UNE
- FACILITÉS DE PAIEMENT (3 FOIS SANS FRAIS)



DISTRIBUTEUR EXCLUSIF

03 85 51 45 45

www.moraco.fr

MORACO
Motorcycle parts

DIAGNOSTIC



MemoBike 6050

Universel, rapide, simple et complet.

Complet et puissant

Le MEMOBIKE 6050 permet d'effectuer une recherche de diagnostic avancé pour les nouvelles motos des plus importantes marques mondiales.

En complément aux fonctions de test et de diagnostic, il peut effectuer quand le constructeur le prévoit, les configurations et/ou les réglages de ECU (ex. Tableau de bord, Abs, Dispositif d'immobilisation, etc.) et il intervient sur certains paramètres du système d'injection ou allumage électronique (Réglages).



Démarrage rapide



Simple d'utilisation

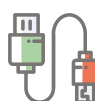

**Mise à jour régulière
via USB**



**Support technique
03 85 51 45 45**





MemoBike 6050

Diagnostiqueur universel - 6050 1700,00 €_{HT}

Processeur Cortex M3 96 MHz - 32 Mo de RAM - 4 Go de mém. flash

Interface USB, recharge, stockage et mise à jour

Alimentation : batterie lithium rechargeable ou externe 5-16 V

Écran LED HD - haut parleur - clavier 9 touches

175 x 112 x 36 mm - 263 g

Fonctions

- Diagnostic standard EOBD Euro 4
- Activation des composants et test : injecteurs, bobine d'allumage, pompe à essence, etc.
- Mise à zéro voyant de service
- Encodage clés
- Déverrouillage anti-démarrage
- Réglage de l'injection (CO)
- Réglage du capteur de papillon des gaz (TPS)
- Configuration anti-démarrage et alarme
- Mise à zéro des paramètres auto adaptatifs
- Réglage du ralenti
- Test de purge d'air et de pression du système ABS
- Lecture et recherche globale des codes d'erreurs stockés à l'intérieur d'ECU
- Paramétrage de la fonction d'enregistreur de données de contrôle de l'unité moteur (ECM)
- Recherche auto et manuelle des ECU
- Base de données des modèles motos, y compris le type de connecteur, de sa position et du type de câble à utiliser
- Affichage des données de l'ECU
- Lecture des défauts mémorisés et actuels (DTC)
- Effacement des défauts mémorisés
- Affichage en direct des données : RPM, tension batterie, angle du papillon des gaz, etc.



Inclus avec le MemoBike 6050

- Guide d'aide avec identification des broches de connexion et diagnostics opérationnels multi-marques
- Câble principal pour la connexion avec les câbles optionnels
- Colliers de câbles universels
- Câbles avec pinces pour batterie
- Câble USB

* Eco-participation 0,84 € H.T. Filière EEE identifiant FR005361_051MBE

Liste de câbles

Référence	Désignation	NET H.T.	Application	Année	Note
6050	Memobike testeur diagnostique universel	1700 €			Éco taxe 0,84€
6050SW-AGG	MISE A JOUR MEMOBIKE 6050	NOUS CONTACTER			
6053	DIVAS (à utiliser avec le 6050)	360 €			Éco taxe 0,84€
SL010520	Câble principal	71 €			
	inclus avec Memo Bike 6050				
SL010051	Câble avec pinces de batterie inclus avec Memo Bike 6050	18,50 €			à utiliser avec: SL010522, SL010477A, SL010460, SL010461, SL010464, SL010475, SL010483, SL010489, SL010490, SL010491, SL010493, SL010499, SL010512, SL010518, SL010525A, SL010526, SL010528, SL010557, SL010562
SL010522	Câble Universel inclus avec Memo Bike 6050	21,50 €	Benelli(1), Daelim (Steezer 125)(3), Geon(1), Honda(1), Hyosung(2), Kawasaki(2), Mash(1)(3), MBK(3), Polaris(3), Suzuki (solo VZ1600)(2), Yamaha(3)		(1) Seulement ABS (2) Seulement injection codes display ou clignotants (3) Seulement Injection
SL010591	Câble Aprilia/Moto Guzzi 8/8 pins	77 €	Aprilia, Moto Guzzi	17-..	Pour tableau de bord Cobo
SL010593	Câble Vespa/Moto Guzzi 5/5 piNS	89 €	Moto Guzzi V9, Vespa	16-..	Pour tableau de bord Cobo et Vespa électriques
SL010595	Câble Slave Betamotor 6 pins	54 €	Betamotor	16-..	
SL010599	Câble Slave OBD Euro V 6 pins	67 €	Moto Guzzi, Piaggio, Vespa	19-..	Seulement vehicules Euro V
SL010603	Câble Slave Royal Enfield 6 pins	75 €	Royal Enfield	09-..	
SL010458	Câble KAWASAKI 4 PIN	45 €	Bajaj, Kawasaki	07-..	
SL010459	Câble KAWASAKI 8 PIN	45 €	Kawasaki	juin-13	Seulement ABS
SL010461	Câble HONDA 3 PIN	50 €	Honda, Mondial	99-07	Seulement injection codes clignotants
SL010464	Câble SUZUKI 4 PIN	50 €	Kawasaki KLV 1000, Suzuki	99-07	Seulement injection codes clignotants
SL010476	Câble CAGIVA 10 PIN	45 €	Cagiva	00-08	
SL010477A	Câble SUZUKI/CAGIVA	120 €	Cagiva, Suzuki	98-..	Seulement réglage injection
SL010480	Câble HARLEY DAVIDSON	60 €	Buell, Harley-Davidson 4 PINS	00-17	
SL010483	Câble APRILIA/DITECH	45 €	Aprilia	00-11	Seulement injection Ditech
SL010490	Câble APRILIA/SAGEM	45 €	Aprilia	01-nov	Seulement injection Sagem
SL010491	Câble PEUGEOT	45 €	Peugeot	févr-16	
SL010493	Câble KYMCO	50 €	Kawasaki J150 et J300, Kymco	07-..	
SL010500	Câble KAWASAKI 4 PIN MY07	45 €	Kawasaki Z750 et Z1000	07-sept	
SL010501	Câble BRP CAN - AM	60 €	BRP Can-Am	06-..	
SL010502	Câble KAWASAKI REG.NE INJ	45 €		#N/A	
SL010505	Câble BENELLI 6 PIN	60 €	Benelli	févr-13	
SL010509	Câble KAWASAKI 6 PIN	45 €	Kawasaki ZG1400 et VN1700	07-sept	
SL010512	Câble SYM 3 PIN	70 €	Adiva, Dafra, Lance. Peugeot LXR 200, SYM, TGB	07-..	
SL010516	Câble POLARIS 8 PIN	60 €	Indian, Polaris, Victory	juin-18	
SL010518	Câble SYSTEME WALBRO	120 €	Aprilia, Bimota	mai-14	Seulement injection Walbro

Référence	Désignation	NET H.T.	Application	Année	Note
SL010526	Câble MV AGUSTA	45 €	MV Agusta	11-..	
SL010528	Câble HONDA HISS 2 PIN	60 €	Honda	99-..	Seulement immobilisation HISS
SL010538	Câble KYMCO CAN 4 PIN	50 €	Kymco (seulement ATV)	07-..	
SL010539	Câble DEALIM CAN 4 PIN	50 €	Daelim	11-..	
SL010541	Câble HARLEY CAN 6 PIN	60 €	Harley-Davidson 6 pins	11-..	
SL010551	Câble HUSQVARNA 6 PIN	60 €	Husqvarna	07-déc	Seulement injection Mikuni
SL010557	Câble KTM	90 €	KTM (battery less)	11-..	
SL010562	Câble BENELLI/KEEWAY SC.6P	60 €	Aeon, AJBenelli, Brixton Motorcycles, Coleman, CSC Motorcycles., FB Mondial, Generic, Geon, Goes, Hisun, Keeway, Macbor, Mash, Minsk, Mitt, Quadro, Riya, Stels, Zongshen	10-..	Injection Delphi, Liteon et Bosch MSE
SL010570	Câble ADAPT KAWASAKI 4 PIN	45 €	Kawasaki KX250F et KX450F	08-..	Réglage injection
SL010589	Câble YAMAHA T-MAX	120 €	Yamaha T-MAX 530 MY12-16 et X-Max 400 MY13-16	déc-16	
SL010481	Câble OBDII/TRIUMPH 16 PIN	70 €	Benneli, Betamotor, BMW, Brough Superior, Fantic Motor, Keeway, KSR Moto, Lambretta, Mash, MH Motorcycles, MZ, Piaggio Porter Triumph, Vervemoto, Victory	97-..	
SL010475	Câble YAMAHA 4 PIN	45 €	Malaguti Password 250, MBK et Yamaha 3 pins	05-..	
SL010508	Câble DUCATI CAN 4 PIN	45 €	Ducati	08-..	
SL010463	Câble SUZUKI 6 PIN	50 €	Arctic-Cat, Boom Trikes, Suzuki	02-..	
SL010510	Câble 4/6 PINMY10	70 €	Bajaj, Kawasaki	10-..	
SL010489	Câble KTM	45 €	Bajaj, Husaberg, Husqvarna, KTM	05-..	
SL010499	Câble PACKARD	45 €	Adiva, Aprilia, Bimota, Cagiva, Cfmoto, Derbi, Ducati, FB Mondial, Garelli, Gas Gas, Gilera, KVN Motor, Laverda, Malaguti, Moto Guzzi, Moto Morini, MV Agusta, Piaggio, Rieju, Sherco, Vespa, Voxan	90-..	
SL010460	Câble HONDA 4 PIN	45 €	Boom Trikes, Honda	03-..	
SL010525B	Câble BMW	90 €			
SL010584	Câble YAMAHA 4 PIN	50 €	Yamaha (seulement 4 pins)	13-..	
SL010605	Câble KAWASAKI 4PIN auto-alimenté	75 €			
SL010606	Câble HONDA 4 PIN auto-alimenté	53 €			



ACCESSOIRES D'ATELIER



Lève moto

NOUVEAUTÉ



Indispensable

Ce modèle universel est l'outil indispensable pour toutes vos opérations d'entretien et de maintenance sur votre moto tout terrain.

Caractéristiques

Plateau antidérapant : 165x275 mm

Hauteur position basse : 290 mm

2 niveaux de hauteur : 380 mm et 395 mm

UP MX LIFT- UPMXL

79,90 €
T.T.C.



Sangles



Orange - RCINGHIAAR15

42,95 €
T.T.C.



Vendues par
paire



Bleu - RCINGHIABL15



Vert - RCINGHIAVE15



Jaune - RCINGHIAI15



Rouge - RCINGHIARS15



Noir - RCINGHIANR25

36,95 €
T.T.C.

Sangles UP



- Dimensions 3,8 cm x 2,1 m
- Crochets recouverts de caoutchouc
- Mousqueton
- Résistance max. 550 kg
- Verrouillage rapide

Rouge - 88SANGLENR

Orange - 88SANGLENO

27,90 €
T.T.C.

Tapis



Tapis- 88TAPIS

160 x 100 cm

43,90 €
T.T.C.

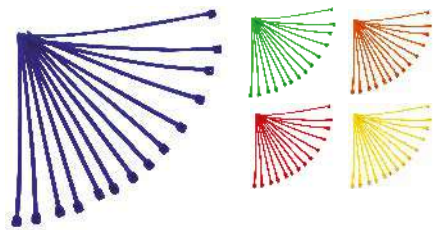

Colliers nylon 3,6 x 180 mm **7,95** € I.T.C.

Colliers nylon 4,8 x 280 mm **8,95** € I.T.C.

Couleur	3,6x180 mm 100 pièces	4,8x180 mm 100 pièces
Orange	RFASC36180AR	RFASC48280AR
Bleu	RFASC36180BL	RFASC48280BL
Jaune	RFASC36180GI	RFASC48280GI
Noir	RFASC36180NR	RFASC48280NR
Rouge	RFASC36180RS	RFASC48280RS
Vert	RFASC36180VE	RFASC48280VE



Scotch américain **13,50** € I.T.C.

Noir RTAPE000NR20
Gris RTAPE000SI20



Verso

Pit board - RLAVSRTNR1 **47,95** € I.T.C.

Marqueur - RPENLAVNR1 **7,40** € I.T.C.



Noir - HOURMT002NR **49,95** € I.T.C.

Bleu - HOURMT002BL

Orange - HOURMT002AR



Soufflets de fourche **29,20** € I.T.C.

ø 42/45-60 mm - 2510N



Purgeur de freins



GO AHEAD

Purgeur - 3908 **204,70** € I.T.C.

Embout - 1016B **9,64** € I.T.C.



Electrolyte 1215 **2,19** € PRIX NET

9 x 1 L
Pour batteries au plomb
Prix au litre
LIVRÉ SÉPARÉMENT, PORT FACTURÉ.



Absorbant 1214 **13,60** € PRIX NET

20 kg
Absorption de tous produits d'atelier polluants : graisse, huile, essence.
Nettoyage final des sols facilité.



Papier absorbant 1211 **11,90** € PRIX NET

Format 26x30cm
Ouate double épaisseur
2 bobines de 1000 feuilles



Pichets doseurs

	Réf.	€ T.T.C.
0,1 L	RMISURCAP100	5,95 €
0,25 L	RMISUR000250	6,95 €
0,5 L	RMISUR000500	7,95 €
1 L	RMISUR001000	8,95 €
1 L	1216	11,45 €



Housse de selle

-  Standard 5011STD
-  Super grip 5011SG

64,90 € I.T.C.
65,90 € I.T.C.



Filet décor 7mm x 6m

24,80 € I.T.C.

Couleur	Réf.	Couleur	Réf.
Orange	5025O	Rouge	5025R
Bleu	5025B	Vert	5025V
Jaune	5025J	Fuchsia	5025F
Blanc	5025BL		



Filet décor Racing

- Vert x8 5026V
- Jaune x8 5026J
- Rouge x12 5026R

21,60 € I.T.C.
21,60 € I.T.C.
29,90 € I.T.C.



Absorbant phonique - 999001

15,50 € I.T.C.

500 x 700 mm



Bouchons d'échappement

Boîte 6x40, 6x60 2550/2560

98,55 € I.T.C.

ø 40 mm 2550P

7,80 € I.T.C.

ø 50 mm 2560P

9,90 € I.T.C.



Pince à freiner - RPINZAFILO01

43,95 € I.T.C.

Fil à tresser - RFILOZINC010

9,95 € I.T.C.

ø0,8mm / 30m

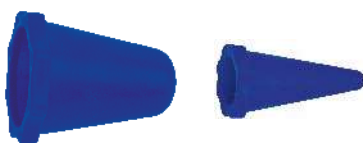

Bouchons d'échappement

ø 14-42mm RTPM001440BL

6,95 € I.T.C.

ø 40-65mm RTPM004065BL

7,95 € I.T.C.



Spatule - RMUDRMBLY300

9,95 € I.T.C.



Brosse chaîne - RCHBRUSHBL11

18,95 € I.T.C.

Trépied R15

94,95 €
T.T.C.



Jaune fluo - RCAVMX0015GF



Noir - RCAVMX0015NR



Blanc - RCAVMX0015BN



Gris - RCAVMX0015GR



Orange fluo - RCAVMX0015AN



Bleu - RCAVMX0015BL



Rose fluo - RCAVMX0015FU



Bac de vidange pour R15

5 L - RR15TANKNR01

27,95 €
T.T.C.



Vert - RCAVMX0015VE



Orange - RCAVMX0015AR



Rouge - RCAVMX0015RS



NEW

Vert fluo - RCAVMX0015VF

Bac de vidange



6 L - RECOTANKVE06

17,95 €
T.T.C.



10 L - RECOTANKVE10

19,95 €
T.T.C.



12 L - RECOTANKVE12

27,95 €
T.T.C.

Bidon R15 remplissage rapide

74,95 €
T.T.C.



Rouge - RGASCARS0020



Vert - RGASCAVE0020

Bleu - RGASCABL0020

Jaune - RGASCAGI0020

Orange - RGASCAAR0020



Bidon R15 remplissage classique

74,95 €
T.T.C.



Orange
Bleu
Jaune
Rouge
Vert

RGASCAAR0017
RGASCABL0017
RGASCAGI0017
RGASCARS0017
RGASCAVE0017



Bouchon remplissage rapide 24,95 €
T.T.C.

Orange RGASCANQFAR0
Bleu RGASCANQFBL0
Jaune RGASCANQFGI0
Rouge RGASCANQFRS0
Vert RGASCANQFVE0



Bouchon remplissage rapide 19,95 €
T.T.C.

Orange RGASCANTBAR0
Bleu RGASCANTBBL0
Jaune RGASCANTBGI0
Rouge RGASCANTBRS0
Vert RGASCANTBVE0



Trépied alu

RCVALUGRGP00 119,95 €
T.T.C.

Trépied Grand Prix en alliage léger d'aluminium soudé à la main avec technologie TIG, complet avec panneau en bois de hêtre et graphique appliqué.

Support remplacement de pneu

219,95 €
T.T.C.

RSMONTAG0018



Troisième main

Permet de garder le démonte pneu dans la bonne position.



Démonte pneu

29,95 €
T.T.C.

L 430 mm - RLEVAMOUSSE1



Tire valve - RTIRAVALVRS1

16,95 €
T.T.C.



Gripsters

	Réf.	€ T.T.C.
1,40' / 1,60'	RFERMACOP16Ø	21,95 €
1,85'	RFERMACOP185	21,95 €
2,15'	RFERMACOP215	21,95 €
2,50'	RFERMACOP250	21,95 €



Manomètre - MANOMETRO01

29,95 €
T.T.C.



ÉQUIPE COMMERCIALE



Éric LACOUR - Responsable commercial

06 09 15 13 01 - eric.lacour@moraco.fr

Alexandre BRUNEL

06 24 94 39 72 - alexandre.brunel@moraco.fr

Dép. 08, 10, 51, 52, 54, 55, 57, 67, 68, 70, 88, 90

Florian RENAUDIE

06 02 00 49 91 - florian.renaudie@moraco.fr

Dép. 16, 17, 24, 33, 79, 85, 86

Sébastien CALONNE

06 24 94 39 49 - sebastien.calonne@moraco.fr

Dép. 09, 11, 31, 32, 40, 46, 47, 64, 65, 66, 81, 82, Andorre

Gérald VALCESCHINI

06 24 94 39 76 - gerald.valceschini@moraco.fr

Dép. 01, 21, 25, 26, 38, 39, 58, 71, 73, 74, 89

Ludovic DECORDE

06 80 27 96 87 - ludovic.decorde@moraco.fr

Dép. 14, 22, 27, 28, 29, 35, 37, 41, 44, 49, 50, 53, 56, 61, 72, 76

Pierre-Marie FAURE

06 24 94 40 02 - pierremarie.faure@moraco.fr

Dép. 03, 07, 12, 15, 18, 19, 20, 23, 36, 42, 43, 45, 48, 63, 69, 87

Richard MARIONI

06 24 94 40 00 - richard.marioni@moraco.fr

Dép. 04, 05, 06, 13, 30, 34, 83, 84, 98

Christopher MARQUET

07 78 68 52 27 - christopher.marquet@moraco.fr

Paris VIII, IX, XV, XVI, XVII, dép. 78, 92, 93, 95

Vincent OBERT

07 79 82 53 64 - vincent.obert@moraco.fr

Dép. 02, 59, 60, 62, 80

Karen JUDITH

07 86 40 78 08 - karen.judith@moraco.fr

Paris I, II, III, IV, V, VI, VII, X, XI, XII, XIII, XIV, XVIII, XIX, XX, dép. 77, 91, 94

Pour commander

 www.moraco.fr

 commande@moraco.fr

 03 85 51 45 45

 03 85 30 64 61

 **Matin 9h - 12h30**
Après-midi 13h30 - 18h
Le vendredi jusqu'à 16h

 **Livraison J+1**
(jusqu'à 70 kg, hors acide à batterie)

si vous **commandez**

avant 14h30 par téléphone,

avant 15h par email ou fax,

avant 16h sur moraco.fr

*Livraison J+2 à J+4 au-delà de 70 kg,
selon le secteur géographique.*

Conditions

Franco de port

Tous produits 299 € HT

Hors commandes Web

Commandes Web 159 € HT

Calculé sur le prix net facturé

Kit chaîne D.I.D. 0 €

À partir de la qualité 2

Minimum de commande 50 € HT

Sauf si franco D.I.D.

Autres frais

Commande < 50 € HT 3 € HT

Modification de commande
après validation BL 1 € HT

Paielement par carte bancaire 1 € HT

Facturation mensuelle < 100 € HT 3 € HT

Frais de port

Commandes inférieures au franco :

enveloppe 8 € HT

commande < 159 € HT 11 € HT

commande < 299 € HT 10 € HT

Express samedi 5 € HT

L'acide de batterie est soumis à un franco de 299€HT quelque soit le moyen de commande. En dessous de ce franco, le port est facturé selon le barème du transporteur

Conditions spéciales

Corse :

• Franco Web à 299 € HT

• Produits dangereux livrés en J+5

Conditions générales de vente

1. Les présentes conditions générales de vente constituent, conformément à l'article L441-6 du Code de commerce, le socle unique de la négociation commerciale. Toute commande doit être signée par le client et entraîne de plein droit l'application des conditions générales de vente ci-dessous, à l'exclusion de toutes autres, sauf accord particulier. Elle devient définitive dès réception de la commande de notre part. Elle ne peut être annulée ou modifiée sans notre accord

2. Les délais de livraison sont mentionnés sur nos catalogues et notre site internet. MORACO fera ses meilleurs efforts pour livrer les marchandises commandées dans les délais précisés. Cependant, ce délai ne constitue pas un délai de rigueur et MORACO ne pourra voir sa responsabilité engagée à l'égard du Client en cas de retard de livraison. En cas de retard supérieur à deux (2) mois, le Client pourra demander la résiliation du contrat suivant une mise en demeure de livrer, adressée à MORACO par lettre recommandée avec demande d'avis de réception et restée infructueuse dans le délai de quinze (15) jours ; cette annulation n'ouvre droit à aucune indemnisation ou pénalité au profit du Client.

Par ailleurs, un retard de livraison ne pourra donner lieu à dommages-intérêts ou pénalités en cas de force majeure, grève, arrêt des transports et des approvisionnements, décisions administratives ou autre événement indépendant de notre volonté.

3. Toutes nos ventes et livraisons sont réputées effectuées Départ Pont de Vaux (Incoterm 2010 – Ex Work), même en cas de facturation franco. Les marchandises voyagent donc aux risques et périls des destinataires à qui il appartient de souscrire toutes assurances nécessaires, de formuler auprès du transporteur toutes réserves et d'exercer tous recours.

4. Les réclamations concernant la qualité des marchandises, à l'exclusion de tout litige de transport, devront être formulées par écrit, directement sur notre site internet www.moraco.fr via l'onglet prévu à cet effet, au plus tard dans les 48 heures de la livraison. Aucun retour de marchandises ne pourra être effectué en l'absence de réclamation formulée sur notre site internet et sans notre accord préalable et écrit. Les frais de retours sont à la charge du client et ceux en port dû seront refusés à la réception. Les marchandises retournées devront être en parfait état et n'avoir jamais servi. Un avoir sera établi sous déduction d'un montant de 10% HT par pièce (forfait de maintenance et de reconditionnement).

5. Outre la garantie légale de vices cachés au titre de l'article 1641 du Code civil auquel il n'est pas dérogé, le vendeur s'engage à remédier à tout défaut de fabrication qui se manifesterait lors de la mise en fonctionnement des marchandises. La présente garantie ne s'applique pas en cas de :

- montage ou utilisation non conforme aux conditions normales d'emploi, dont l'utilisation en compétition ;
- montage d'une pièce par un non-professionnel de la moto (sauf conditions particulières).

La garantie est strictement limitée au remplacement des pièces d'origine reconnues défectueuses, non conformes ou manquantes, à l'exclusion de la réparation de tous dommages indirects, matériels et immatériels

6. Nos prix sont stipulés Départ Pont de Vaux (Incoterm 2010 – Ex Work), hors taxes, selon les conditions économiques en vigueur lors de la confirmation de commande, sous réserve que les livraisons soient effectuées dans les 3 mois suivant la commande ou qu'une date de livraison postérieure de plus de 3 mois soit prévue à la commande. Ils peuvent être révisés ou complétés du fait de plus-values. Toute modification de prix prendra effet postérieurement à la modification des prix apparaissant sur notre site internet.

De convention expresse entre les Parties, il ne sera pas fait application des dispositions de l'article 1223 du Code civil.

Nos factures, éditées en fin de mois, sont payables à 30 jours fin de mois par LCR magnétique, sauf conditions particulières. Le paiement au comptant ne donne droit à aucun escompte.

Toute somme non payée à l'échéance porte de plein droit intérêt à un taux égal à trois fois le taux de l'intérêt appliqué par la BCE majoré de 10 points de pourcentage, sans préjudice du droit de faire cesser l'infraction. Les frais de recouvrement sont fixés au minimum à 40 €, sauf frais réels supérieurs. Le non-paiement d'une seule facture entraîne l'exigibilité des échéances en cours et déchéance des remises spéciales ou promotions.

Le bénéfice des remises et ristournes éventuelles est subordonné au paiement intégral des factures qui leur servent de base de calcul.

7. Le transfert de propriété des marchandises vendues est suspendu jusqu'au paiement effectif de l'intégralité du prix en principal et accessoire. Toutefois, le transfert des risques est effectué à la charge de l'acheteur dès la livraison conformément à l'Incoterm 2010 – Ex Work tel que mentionné à l'article 3 ci-dessus

8. Le matériel publicitaire est notre propriété exclusive et à ce titre ne peut être modifié par quiconque n'appartenant pas à notre société ou n'agissant pas en son nom. Il doit être utilisé pour la seule présentation des articles vendus par MORACO et maintenu en bon état. Il peut être repris à tout moment par notre société.

9. En cas d'inexécution d'une quelconque des obligations de l'acheteur, la vente pourra être résolue de plein droit à notre seul gré, sans préjudice de dommages-intérêts.

10. En cas de litige, seule la loi française est applicable et les tribunaux de notre siège social seront seuls compétents, même en cas d'appel en garantie ou de pluralité de défendeurs.

Merci à tous nos partenaires





Commandez 24h/24 et 7j/7

Stocks en temps réel

Franco 159 €

Tél. 03 85 51 45 45 - commande@moraco.fr

moraco.fr

